

# jWIN

**Portable MP3 CD / CD player with  
Cassette and AM/FM Stereo radio**



## **Instruction Manual**

**JX-CD483D**



Please read this manual carefully before operating and save it for future reference.

**Have a question? Please visit <http://www.jWIN.com>**

## USER SAFETY GIUDE

### IMPORTANT SAFETY INSTRUCTIONS



**WARNING:** To prevent fire or shock hazard, do not expose this appliance to rain or moisture.

	<b>CAUTION</b> <b>RISK OF ELECTRIC SHOCK</b> <b>DO NOT OPEN</b>	
These markings are located on the bottom, side or back of the unit.		
<b>CAUTION:</b> To prevent the risk of electric shock, do not remove cover (or back). Non- user-serviceable parts inside. Refer servicing to a service professional.		

- The lightning flash with an arrowhead symbol, within an equilateral triangle, is intended to alert the user to the presence of un-insulated "dangerous voltage" within the product's enclosure that may be of sufficient magnitude to constitute a risk of electric shock to a person.
- The exclamation point within an equilateral triangle is intended to alert the user to the presence of important operating, maintenance and servicing instructions in the literature accompanying the appliance.

**Dripping warning:** This product shall not be exposed to any dripping or splashing, and no objects filled with liquids, such as vases, shall be placed on or near the product.

**Ventilation warning:** "The normal ventilation of the product shall not be impeded for intended use." (Minimum distances must be kept around the apparatus for sufficient ventilation, especially while use of the apparatus is in tropical and/or moderate climates.)

	Dispose of old batteries safely. <b>Do not throw them into a fire.</b>
	<p><b>LASER SAFETY</b> This unit utilizes laser technology. Only a qualified professional should remove the cover or attempt to service this device, due to possible eye injury.</p> <p><b>CAUTION</b></p> <ul style="list-style-type: none"> <li>• Use of controls or adjustments or performance of procedure other than specified herein may result in hazardous radiation exposure.</li> <li>• Hazardous laser radiation when open and interlock defeated.</li> </ul> <p><b>DANGER</b> Invisible laser radiation when open and interlock failure. Avoid direct exposure to beam.</p>

## USER SAFETY GUIDE

### INSTRUCTIONS ON ENVIRONMENT PROTECTION

Do not dispose of this product in the usual household garbage at the end of its life cycle; bring it to a collection point for the recycling of electrical and electronic appliances. This symbol on the product means the instructions for use or the packing will inform about the methods for disposal. The materials are recyclable as mentioned in its marking. By recycling, material recycling, or other forms of re-utilization of old appliances, you make an important contribution to protect the environment. Please inquire at your local community administration for the authorized disposal location.



### IMPORTANT SAFETY PRECAUTIONS

1. **READ INSTRUCTIONS** - All safety and operating instructions should be read before the appliance is operated.
2. **RETAIN INSTRUCTIONS** - The safety and operating instructions should be retained in a secure place for future reference.
3. **HEED WARNINGS** - All warnings on the appliance and in the operating instructions should be observed.
4. **FOLLOW INSTRUCTIONS** - All operating and use instructions should be followed.
5. **WATER AND MOISTURE** - The appliance should not be used near water. For example: near a bathtub, kitchen sink, laundry tub, and swimming pool or even in a wet basement.
6. **VENTILATION** - The appliance should be situated so that its location and position does not interfere with its proper ventilation. For example, the appliance should not be situated on a bed, sofa, rug or similar surface that may block the ventilation openings; or, be placed in a built-in installation, such as a bookcase or cabinet that may impede the flow of air through the ventilation openings.
7. **HEAT** - The appliance should be situated away from heat sources such as radiators, heat registers, stoves, or other appliances (including amplifiers) that produce heat.
8. **POWER SOURCES** - The appliance should be connected to a power supply only of the type described in the operating instructions or as marked on the appliance.
9. **GROUNDING AND POLARIZATION** - Precautions should be taken to ensure that the grounding or polarization of the appliance is correct.
10. **POWER CORD PROTECTION** - Power supply cords should be routed so that they are not likely to be walked on or obstructed by items placed upon or against them. Pay particular attention to cords at plugs, convenience receptacles, and the point at which they exit from the appliance.
11. **CLEANING** - The appliance should be cleaned only as recommended by the manufacturer.
12. **POWER LINES** - An outdoor antenna should be located away from power lines.
13. **NONUSE PERIODS** - The power cord of the appliance should be unplugged from the outlet when the appliance is to be left unused for an extended period of time.

## USER SAFETY GUIDE

### IMPORTANT SAFETY PRECAUTIONS – CONTINUED

14. **OBJECT and LIQUID ENTRY** - Care should be taken so that objects do not fall and liquids are not spilled into the device's openings.
15. **CARTS AND STANDS** - The appliance should be used only with a cart or stand that is recommended by the manufacturer. An appliance and cart combination should be moved with care. Quick stops, excessive force, and uneven surfaces may cause the appliance and cart combination to overturn. 
16. **WALL OR CEILING MOUNTING** - If the appliance is mounted to a wall or ceiling, it should be mounted only as recommended by the manufacturer.
17. **DAMAGE REQUIRING SERVICE** - The appliance should be serviced by qualified service professional when:
  - a. The power-supply cord or plug has been damaged.
  - b. Objects have fallen into, or liquid has been spilled into the appliance's apertures.
  - c. The appliance has been exposed to rain.
  - d. The appliance has been dropped and suffered damage.
  - e. The appliance does not appear to operate normally or exhibits a marked change in performance.
18. **SERVICING** - The user should not attempt to service the appliance beyond that described in the user's operating instructions. All other servicing should be referred to qualified service professional.
19. **PROTECTIVE ATTACHMENT PLUG** - The appliance is equipped with an attachment plug that has an overload protection. This is a safety feature. If replacement of the plug is required, be sure the service technician has used a replacement plug specified by the manufacturer that has the same overload protection as the original plug. (UK Version Only)
  - To prevent fire or electric shock, do not expose the unit to rain or moisture.
  - Never attempt to open the cabinet. Dangerous high voltages are present in the unit. Always refer servicing to a qualified technician.

## TABLE OF CONTENTS

<b>1. Getting Started</b>	
a. Introduction .....	5
b. Location of Controls (top, speaker, right, left) .....	6
c. AC operation .....	7
d. Battery operation.....	7
e. FM antenna.....	7
f. Bass Boost.....	7
g. Auxiliary (AUX) mode.....	7
h. Listening with Stereo Headphones .....	8
i. Listening to the Radio.....	8
j. Listening to the Cassettes.....	8
k. Listening to the CDs and MP3 CDs.....	8
<b>2. Operational Instructions</b>	
a. Audio CD playback.....	9
b. Play/Pause mode.....	9
c. Skip and Search mode.....	9
d. Repeat Mode .....	10
e. Random play mode.....	10
f. Program Mode .....	10
g. MP3 playback .....	11
h. FM Stereo Indicator .....	14
<b>3. Maintenance &amp; Specifications</b>	
a. Notes on CDs .....	15
b. Cleaning the lens .....	15
c. Cleaning the cabinet .....	15
d. Troubleshooting.....	16
e. Technical specifications .....	17

## GETTING STARTED

Thank you for purchasing the JX-CD483D. Unpack the unit and make sure to put aside all accessories so they will not be lost. We recommend that you retain the original carton and packaging materials for future use, should you transport or ship the unit in the future.

### Portable stereo audio system

- Top loading MP3 CD / CD player
- Supports MP3 CD / CD / CD-R / CD-RW
- 20 tracks programmable
- Analog AM / FM stereo radio with digital display
- Single cassette recorder
- Bass boost system (BBS)
- 3.5mm built in stereo headphone jack & Aux in jack
- Skip and search functions

### What's included

- Portable CD Boom box
- Instruction manual
- Warranty card



# GETTING STARTED

## Location of Controls

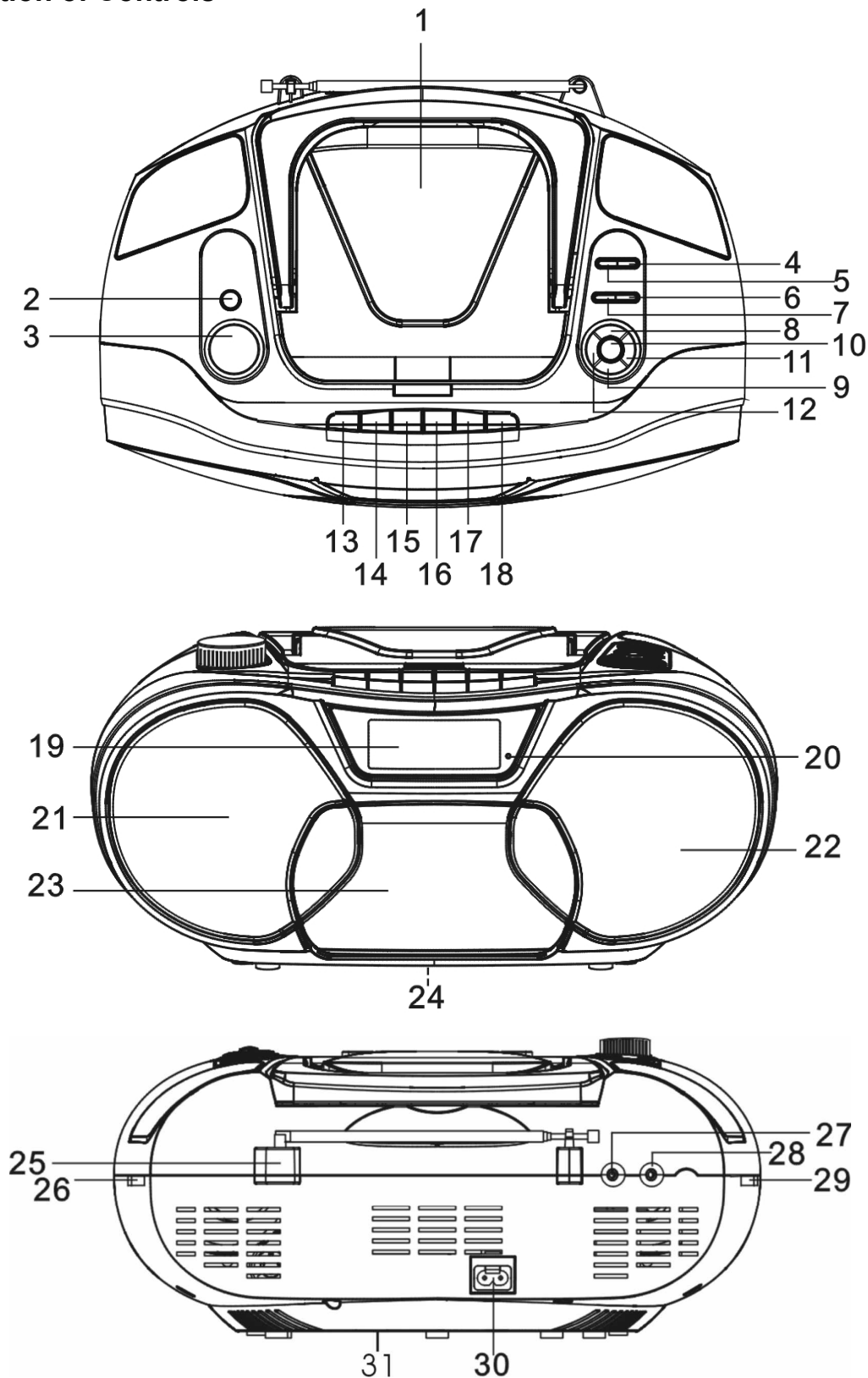

## GETTING STARTED

### Location of Controls

- |                            |                             |
|----------------------------|-----------------------------|
| 1. CD DOOR                 | 17. CASSETTE PLAY BUTTON    |
| 2. BASS BOOST BUTTON       | 18. CASSETTE RECORD BUTTON  |
| 3. VOLUME KNOB             | 19. LCD DISPLAY             |
| 4. FOLDER+ BUTTON          | 20. FM STEREO LED INDICATOR |
| 5. FOLDER- BUTTON          | 21. SPEAKER LEFT            |
| 6. SKIP/SEARCH+ BUTTON     | 22. SPEAKER RIGHT           |
| 7. SKIP/SEARCH -BUTTON     | 23. CASSETTE DOOR           |
| 8. 10+ BUTTON              | 24. BATTERY COMPARTMENT     |
| 9. STOP BUTTON             | 25. FM ANTENNA              |
| 10. PLAY/PAUSE BUTTON      | 26. BAND SWITCH             |
| 11. MODE BUTTON            | 27. AUX IN JACK             |
| 12. PROGRAM BUTTON         | 28. HEADPHONE JACK          |
| 13. CASSETTE PAUSE BUTTON  | 29. FUNCTION SWITCH         |
| 14. CASSETTE STOP BUTTON   | 30. AC SOCK                 |
| 15. CASSETTE F.FWD BUTTON  | 31. AC 110/ 220V SWITCH     |
| 16. CASSETTE REWIND BUTTON |                             |

### AC Operation

Before operating the JX-CD483D, make sure that the voltage on the unit corresponds to the voltage of your local area. Unravel the AC Line Cord; insert one end into an AC socket on the unit and the other end into a standard AC outlet.

1. In case of malfunction due to electrostatic discharge (ESD), reset the unit by reconnecting the AC cord again to resume to normal operation.
2. When not in use, unplug the AC power cord from the AC power socket.
3. You may adjust the voltage of the unit using the AC 110/ 220V switch located at "31" on Location of controls of the unit.

### Battery Operation

Disconnect the AC Cord. Open the **BATTERY COMPARTMENT** and insert 2/UM-"C" size x 8 batteries (not included) making sure that the battery polarity (+/-) is observed. Remove the batteries if the unit will not be used for a long period of time.

### Antenna

For best FM reception, fully extend the **FM ANTENNA**. For AM reception, the unit has a built-in antenna, turn the whole unit for best reception.

### Bass Boost

To increase bass at all volume levels, push the **BASS BOOST BUTTON** to **ON** position to boost the low frequency tone for an emphasized bass sound. To release the super bass, simply push the button again.

### Auxiliary (AUX) Mode

1. Slide the **FUNCTION SWITCH** to the **AUX** position.
2. Connect the earphone socket from the Auxiliary unit (e.g. MP3 player or MD player) into **AUX-IN** jack on the rear of this product via an Audio Line Cord (3.5mm plug on both ends; not supplied).
3. Play the Auxiliary unit. Music from the Auxiliary unit can be listened through the speaker of this product.



## GETTING STARTED

### Listening with Stereo Headphones

For private listening, insert the plug of a Stereo Headphone into the **STEREO HEADPHONE JACK** and adjust the **VOLUME CONTROL KNOB** accordingly. During the use of headphones the Speakers are automatically disconnected.

### Listening to the Radio

Slide the **FUNCTION SWITCH** to the **RADIO** position. Slide the **BAND SWITCH** to the desired waveband. Turn the **TUNING KNOB** to your desired radio station. Adjust the sound level by rotating the **VOLUME CONTROL KNOB**. To turn off the radio, simply slide the **FUNCTION SWITCH** to **TAPE (OFF)** position.

**Note:** Radio frequency is shown on the **LCD DISPLAY**.

### Listening to Cassettes

Slide the **FUNCTION SWITCH** to the **TAPE (OFF)** position. Open the **CASSETTE DOOR** and place a cassette tape in the player. Use the Cassette Controls (**PLAY**, **PAUSE**, **F.FWD**, **REWIND**, **RECORD**, or **STOP**) to control the cassette playback. Adjust the sound level by rotating the **VOLUME CONTROL KNOB**.

### Listening to CDs and MP3 CDs

Open the **CD DOOR** by pulling it in an upward direction. Place a CD disc into the **CD COMPARTMENT** and close the **CD DOOR**. Set the **FUNCTION SWITCH** to the **CD** position. Adjust the sound level by rotating the **VOLUME CONTROL KNOB**. Follow the Operational Instructions in the following pages of this manual.

**Note:** Before playing a CD or MP3 CD make sure the **CD DOOR** is properly closed.

# OPERATIONAL INSTRUCTIONS

## Audio CD Playback

1. When the **CD DOOR** is closed and a CD is inside, the total number of the tracks in the disc show on the **LCD DISPLAY** and will enter Stop mode. The **DISC** indicator will always show on the **LCD DISPLAY** when the JX-CD483D is in CD mode.

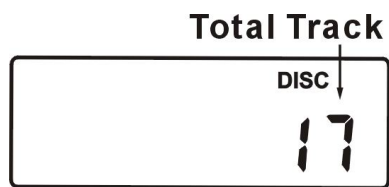

2. If there has no disc inside, the **LCD DISPLAY** will show "no" and remain in Stop mode.



3. If the **CD DOOR** is not closed, the **LCD DISPLAY** will show " - - -".



## PLAY/PAUSE MODE

1. When the **PLAY/PAUSE BUTTON** is pressed during CD stop mode, the first track will play. The Play Indicator "▶" will show on the **LCD DISPLAY**. The **LCD DISPLAY** will also show the number of the track playing.

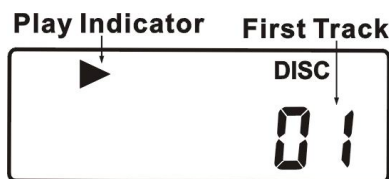

2. For interruption while the CD is playing, press the **CD PLAY/PAUSE BUTTON** once. Playback is now paused and the Play Indicator "▶" will blink continuously on the **LCD DISPLAY**.

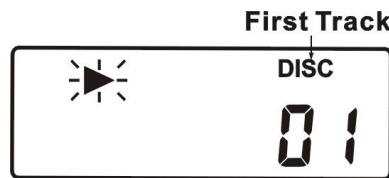

3. Though the sound stops, the disc will continue to spin. To re-start playback, press the **PLAY/PAUSE BUTTON** again. The music will start from the exact position where it was interrupted.

4. To stop the CD, press the **STOP BUTTON** once in Play or Pause mode. The **LCD DISPLAY** will show the total number of tracks on the disc again.

5. To turn off the unit, slide the **FUNCTION SWITCH** to **OFF** position.

## SKIP AND SEARCH MODE

1. In play or pause mode, when **CD SKIP/SEARCH** **▶▶** or **CD SKIP/SEARCH** **◀◀** **BUTTON** is pressed once, the player will advance to the next track or return to the beginning of the track.
2. During play mode, when **CD SKIP/SEARCH** **▶▶** or **CD SKIP/SEARCH** **◀◀** **BUTTON** is pressed and held, it will search the track with audible high-speed forward or backward playback.

## OPERATIONAL INSTRUCTIONS

### REPEAT MODE

- Repeat 1:**  
When the **MODE BUTTON** is pressed once, the **REPEAT** indicator show on the **LCD DISPLAY**. This single track of music will be repeated.
- Repeat All:**  
When the **MODE BUTTON** is pressed twice, the **REPEAT ALL** indicator show on the **LCD DISPLAY**. The whole disc will be played continuously.
- To cancel the Repeat Function**  
Press the **MODE BUTTON** repeatedly until the Repeat Indicator disappears from the **LCD DISPLAY**.

Track 8 is to be repeated

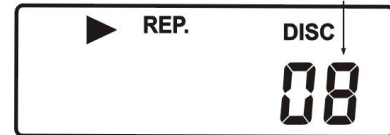

Repeat ALL Indicator



### RANDOM PLAY MODE

This feature allows the track on the disc to be played in a random order.

- In CD stop mode, press the **MODE BUTTON** three times. The **RANDOM** indicator show on the **LCD DISPLAY** and all music will play in random order.
- To cancel the Random play function, press the **MODE BUTTON** again. The **RANDOM** indicator will disappear from the **LCD DISPLAY**.



### PROGRAM MODE

- During the CD stop mode, press the **PROGRAM BUTTON** once. The **PROGRAM** indicator and the number of Program to be memorized starts from the first program "P01" will blink continuously on the **LCD DISPLAY**.
- Press the **CD SKIP/SEARCH** **»»** or **SKIP/SEARCH** **««** **BUTTON** to your desired musical track, the **LCD DISPLAY** will show the appropriate track number. Press the **PROGRAM BUTTON** to store this track in memory.
- Repeat above procedure until all desired tracks have been programmed. A total of 20 tracks can be stored in memory.

**Note:** When the **SKIP/SEARCH** **»»** or **SKIP/SEARCH** **««** **BUTTON** is pressed, it will always show the last programmed track first to recall your memory.

After programming, the **LCD DISPLAY** will show "**PROGRAM** \_ \_ \_" and flash continuously.



## OPERATIONAL INSTRUCTIONS

### Audio CD Playback-continued

#### PROGRAM MODE-continued

3. Press the **CD PLAY/PAUSE BUTTON** once to start the program playback and the CD play Indicator “▶” will light up.

4. To check the program you have stored after complete programming, press the **PROGRAM BUTTON** once during CD stop mode, then press the **CD SKIP/SEARCH ►► BUTTON** once, The **LCD DISPLAY** will show the first programmed track number. Repeat above procedure to read all the programmed memory.



5. To cancel the programmed memory:

- During the CD stop mode, press the **CD STOP BUTTON** once, or
- Open the **CD DOOR** during the CD stop mode.

The Program Indicator will disappear from the **LCD DISPLAY**.

### MP3 CD Playback

1. When the **CD DOOR** is closed and an MP3 disc is inside, the total number of the tracks in the disc will show on the **LCD DISPLAY** and will enter the Stop mode. The **DISC** indicator will always show on the **LCD DISPLAY** when the JX-CD483D is in MP3 CD mode.

#### Total Track Number

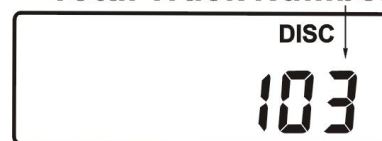

2. When no disc is loaded, the **LCD DISPLAY** will show “NO” and remain in Stop mode.

3. If the CD DOOR is not closed, the DISPLAY will show “- - -”.

#### PLAY/PAUSE MODE

1. When the **PLAY/PAUSE BUTTON** is pressed during CD stop mode, the first track will be played. The Play Indicator “▶” will light. The **MP3** Indicator will show as well to indicate MP3 Disc is playing. The **LCD DISPLAY** will show the specific track number being played.



2. MP3 music can be stored on a CD Disc with or without folders depending on your MP3 burning method. To select specific musical tracks inside an MP3 disc, follow these instructions:
- If an MP3 disc is downloaded without dividing into folders, all track numbers will be shown directly on the **LCD DISPLAY**. The Album number will only show "00" after pressing the **FOLDER BUTTON**.
  - If music is stored into different folders, select the specific Album number first by pressing the **FOLDER UP/DOWN (+/-) BUTTON**. Press the **CD SKIP/SEARCH ►►** or **SKIP/SEARCH ◀◀ BUTTON** to select the Track number inside this Album.

#### No.68 Tracks



## OPERATIONAL INSTRUCTIONS

### MP3 CD Playback-continued PLAY/PAUSE MODE-continued

**Example:**

To select Album # 4, track # 3.

**STEP – 1:** Press the **FOLDER UP/DOWN (+/-) BUTTON** to select the Album # 4.



**STEP – 2:** Press the **CD SKIP/SEARCH ►►** or **SKIP/SEARCH ◀◀** **BUTTON** to select the Track # 3 inside this Album # 4.



3. To interrupt MP3 disc playback, press the **CD PLAY/PAUSE BUTTON** once. The disc is now in Pause mode. The Play Indicator “▶” will blink continuously on the **LCD DISPLAY**.
4. Though the sound stops, the disc will continue to spin. To re-start playback, press the **CD PLAY/PAUSE BUTTON** again. The music will start from the exact position where it was interrupted.
5. To stop the MP3 disc, press the **CD STOP BUTTON** once in Play or Pause mode.
6. To turn off the unit, slide the **FUNCTION SWITCH** to the **OFF** position.

### REPEAT MODE

**1. Repeat 1:**

When the **MODE BUTTON** is pressed once, the **REPEAT** Indicator will light. This single track of music will be repeated.



**2. Repeat Folder:**

When the **MODE BUTTON** is pressed twice, the **REPEAT** and **ALBUM** indicators will show. This folder will be play repeatedly.

**Note:** The folder number and the track number will show every 2 seconds alternatively.



**3. Repeat All:**

When the **MODE BUTTON** is pressed three times, the **REPEAT ALL** Indicator will show. The whole disc will play continuously.



**4. To cancel the Repeat Function**

Press the **MODE BUTTON** repeatedly until the **REPEAT** Indicator disappears from the **LCD DISPLAY**.

## OPERATIONAL INSTRUCTIONS

### MP3 CD Playback-continued

#### RANDOM PLAY MODE

This feature allows the tracks on the disc to be played in a random order.

1. During the CD Stop mode, press the **MODE BUTTON** four times, the **RANDOM** Indicator will show on the **LCD DISPLAY** and all music will be played in random order automatically.



2. To cancel the Random Play function, press the **MODE BUTTON** again, The **RANDOM** Indicator will disappear from the **LCD DISPLAY**.

#### SKIP AND SEARCH

1. In play or pause mode, when **CD SKIP/SEARCH** **»»** or **CD SKIP/SEARCH** **««** **BUTTON** is pressed once, it will go to the next track or go back to the beginning of the track.
2. In play mode, when **CD SKIP/SEARCH** **»»** or **CD SKIP/SEARCH** **««** **BUTTON** is pressed once and held, it will search the track with audible high speed forward or backward playback.

#### PROGRAM MODE

1. In the CD stop mode, press the **PROGRAM BUTTON** once. The **PROGRAM** Indicator and the number of Program to be memorized starts from the first program "001" will light and blink continuously. Press the **FOLDER UP/DOWN (+/-) BUTTON**, then press **CD SKIP/SEARCH** **»»** or **CD SKIP/SEARCH** **««** **BUTTON** to select your desired musical track, the **LCD DISPLAY** will show the track number of the specific Album to be programmed. Press the **PROGRAM BUTTON** to store this track in memory.
2. Repeat the above procedure until all desired tracks have been programmed.  
**Note:** When the **FOLDER UP/DOWN (+/-) BUTTON** is pressed, it will always show the last programmed Album number first to recall your memory. A total of 20 tracks can be stored into memory. After programming is complete, the **LCD DISPLAY** will show **PROGRAM** **\_ \_ \_** and blink continuously.
3. To begin Programmed playback, press the **CD PLAY/PAUSE BUTTON** once. The CD Play Indicator "▶", **PROGRAM** and the track number of the specific Album will light.



**Example:** Album # 3, Track # 2.

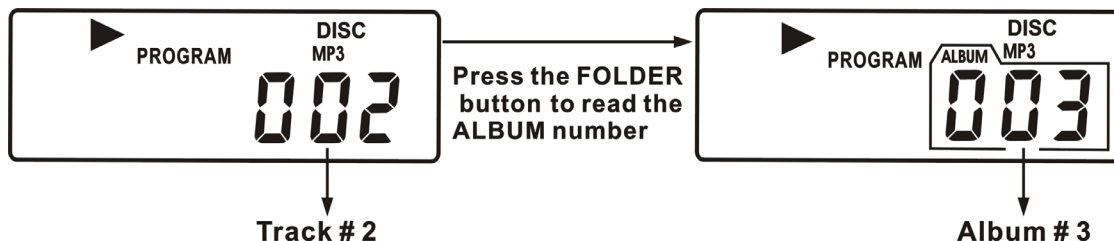

## OPERATIONAL INSTRUCTIONS

### MP3 CD Playback-continued

#### PROGRAM MODE-continued

4. To check the program you have stored after programming is complete, press the **PROGRAM BUTTON** once during the CD Stop mode. The **LCD DISPLAY** will show "P0 1" and blink continuously. Press the **FOLDER UP/DOWN (+/-) BUTTON** to read the Album number. Press the **CD SKIP/SEARCH ►►** or **CD SKIP/SEARCH ◄◄** **BUTTON** to read the specific track number of said Album. Press the **PROGRAM BUTTON** again, **LCD DISPLAY** will show "P02" and blink continuously. Repeat the above procedure to check all stored programs.
5. To cancel the programmed memory:
  - During the CD stop mode, press the **CD STOP BUTTON** once or
  - Open the CD Door during the CD stop mode.

The **PROGRAM** Indicator will disappear from the **LCD DISPLAY**.

### FM Stereo indicator

1. In FM ST mode, If FM is selected, ensure the telescopic antenna is fully extended and positioned vertically, and clear station is selected, the FM ST indicator light turn on.
2. In the case of stereo stations with a bad (noisy) reception, we recommend band switch from **FM ST** slide to **FM** position, and the FM ST indicator light turn off.

## MAINTENANCE

### Notes on CDs

1. Before playing, clean the CD with a cleaning cloth. Wipe the CD from the center out to the ends.
2. Do not use solvents such as benzine, thinner, commercially available cleaners or anti-static spray intended for vinyl LPs.
3. Do not expose the CD to direct sunlight or heat sources such as hot air ducts. Do not expose to direct sunlight, nor leave CDs in a car, as there can be a considerable rise in temperature.
4. Do not stick paper or sticker on the CD. Do not scratch, dirt or fingerprints on the CD, for it may cause tracking error.

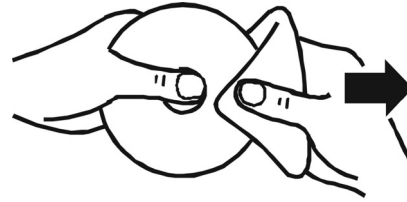

### Cleaning the lens

If the lens becomes dirty, it may cause a skipping of sound during CD operation. Clean with a commercially available lens cleaner.

### Cleaning the cabinet

Clean the cabinet, panel and controls with a soft cloth slightly moistened with a mild detergent solution. Do not use any type of abrasive pad, scouring powder, or solvent, such as alcohol or benzine.



## TROUBLESHOOTING GUIDE

When the instructions in this manual are followed, this unit should function properly. However, if any of the following difficulties occur and cannot be corrected by the user or if a problem arises that is not mentioned here, please contact jWIN Customer Service or a qualified service technician.

1. Unit Does Not Play
  - Unit may be disconnected from power source (No AC connection or batteries). Check connection.
  - Disc is not correctly set. CDs should be inserted label side up.
  - Disc is scratched or dirty. Please clean.
  - The lens is dirty. Wipe clean gently with soft, dry cloth. Follow the instructions of the lens cleaner.
  - There is moisture on the lens wait an hour and try again.
2. No Sound, Distorted Sound or Feedback
  - Ensure plugs are inserted firmly.
  - Wipe off plugs with clean cloth.
  - Disc is scratched or dirty. Please clean.
  - Volume control is turned down. Please increase.
3. Radio Reception is Unclear
  - Radio station frequency may be weak. Adjust antenna.
  - If FM station, **BAND** switch may be set to **FM ST**. Slide **BAND** switch to **FM**.

## SPECIFICATIONS

- Audio Output:  $2W_{RMS}$  (L) +  $2W_{RMS}$  (R)
  - Total:  $4W_{RMS}$  /  $8W_{PEAK}$  /  $80W_{PMPO}$
- Frequency Range
  - AM: 530kHz – 1710kHz
  - FM: 88MHz – 108MHz
- Connectivity
  - 3.5mm stereo headphone jack
  - 3.5mm Aux in jack
- Power Requirement
  - AC 110/220V~60/ 50Hz
  - Battery: 12V (8 x “C” size or UM2 batteries, not included)
- Power Consumption:  $\leq 15W$
- Unit Dimensions (W x H x D): 13.78” x 6.34” x 9.41 (350mm x 161mm x 239mm)

\* Specifications and features are subject to change without prior notice.



# **jWIN**

**TEL: 516-626-7188**

**FAX: 516-626-7105**

**website: [www.jWIN.com](http://www.jWIN.com)**

© 2007 jWIN Electronics Corp. All rights reserved. No portion of this printed material or product enclosed herewith including design, shape and graphics, may be reproduced or transmitted in any form without prior written consent of jWIN Electronics Corp. by any means, electronic or mechanical, including photocopying, recording or use of an information storage and retrieval system. Any unauthorized distribution or reproduction of this printed material or product, or any portion thereof, will be prosecuted to the fullest possible extent of the law.

Printed in China