

JVC



CD/CDR MULTIPLE COMPACT DISC RECORDER

XL-R5000BK

COMPU LINK
Component

COMPACT
disc
DIGITAL AUDIO
Recordable

COMPACT
disc
DIGITAL AUDIO
ReWritable

COMPACT
disc
DIGITAL AUDIO

3-CD
PLAY & EXCHANGE

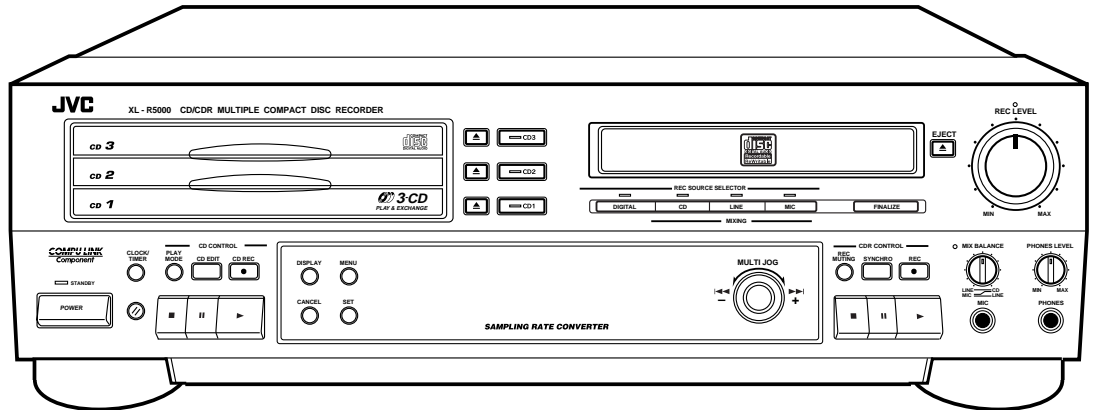
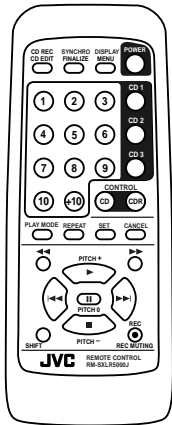

INSTRUCTIONS

For Customer Use:

Enter below the Model No. and Serial No. which are located on the rear, bottom or side of the cabinet. Retain this information for future reference.

Model No. _____

Serial No. _____

LVT0452-001C
[J/C/B/U]

Warnings, Cautions and Others

For U.S.A.

This equipment has been tested and found to comply with the limits for a Class B digital device, pursuant to part 15 of the FCC Rules. These limits are designed to provide reasonable protection against harmful interference in a residential installation.

This equipment generates, uses and can radiate radio frequency energy and, if not installed and used in accordance with the instructions, may cause harmful interference to radio communications. However, there is no guarantee that interference will not occur in a particular installation. If this equipment does cause harmful interference to radio or television reception, which can be determined by turning the equipment off and on, the user is encouraged to try to correct the interference by one or more of the following measures:

Reorient or relocate the receiving antenna.

Increase the separation between the equipment and receiver.

Connect the equipment into an outlet on a circuit different from that to which the receiver is connected.

Consult the dealer or an experienced radio/TV technician for help.

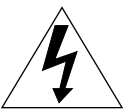

The lightning flash with arrowhead symbol, within an equilateral triangle is intended to alert the user to the presence of uninsulated "dangerous voltage" within the product's enclosure that may be of sufficient magnitude to constitute a risk of electric shock to persons.



The exclamation point within an equilateral triangle is intended to alert the user to the presence of important operating and maintenance (servicing) instructions in the literature accompanying the appliance.

IMPORTANT for the U.K.

DO NOT cut off the mains plug from this equipment. If the plug fitted is not suitable for the power points in your home or the cable is too short to reach a power point, then obtain an appropriate safety approved extension lead or consult your dealer.

BE SURE to replace the fuse only with an identical approved type, as originally fitted.

If nonetheless the mains plug is cut off ensure to remove the fuse and dispose of the plug immediately, to avoid a possible shock hazard by inadvertent connection to the mains supply.

If this product is not supplied fitted with a mains plug then follow the instructions given below:

IMPORTANT.

DO NOT make any connection to the terminal which is marked with the letter E or by the safety earth symbol or coloured green or green-and-yellow.

The wires in the mains lead on this product are coloured in accordance with the following code:

Blue : Neutral
Brown : Live

As these colours may not correspond with the coloured markings identifying the terminals in your plug proceed as follows:

The wire which is coloured blue must be connected to the terminal which is marked with the letter N or coloured black.

The wire which is coloured brown must be connected to the terminal which is marked with the letter L or coloured red.

IF IN DOUBT - CONSULT A COMPETENT ELECTRICIAN.

WARNING: TO REDUCE THE RISK OF FIRE OR ELECTRIC SHOCK, DO NOT EXPOSE THIS APPLIANCE TO RAIN OR MOISTURE.

For Canada & USA

Caution — POWER switch!

Disconnect the mains plug to shut the power off completely. The POWER switch in any position does not disconnect the mains line. The power can be remote controlled.

Attention — Commutateur POWER!

Déconnecter la fiche de secteur pour couper complètement le courant. Le commutateur POWER ne coupe jamais complètement la ligne de secteur, quelle que soit sa position. Le courant peut être télécommandé modèle.

For other countries

Caution —  switch!

Disconnect the mains plug to shut the power off completely. The switch in any position does not disconnect the mains line. The power can be remote controlled.

For Canada/pour le Canada

THIS DIGITAL APPARATUS DOES NOT EXCEED THE CLASS B LIMITS FOR RADIO NOISE EMISSIONS FROM DIGITAL APPARATUS AS SET OUT IN THE INTERFERENCE-CAUSING EQUIPMENT STANDARD ENTITLED "DIGITAL APPARATUS", ICES-003 OF THE DEPARTMENT OF COMMUNICATIONS.
CET APPAREIL NUMERIQUE RESPECTE LES LIMITES DE BRUITS RADIOELECTRIQUES APPLICABLES AUX APPAREILS NUMERIQUES DE CLASSE B PRESCRITES DANS LA NORME SUR LE MATERIEL BROUILLEUR: "APPAREILS NUMERIQUES", NMB-003 EDICTEE PAR LE MINISTRE DES COMMUNICATIONS.

CAUTION

To reduce the risk of electrical shocks, fire, etc.:

1. Do not remove screws, covers or cabinet.
2. Do not expose this appliance to rain or moisture.

ATTENTION

Afin d'éviter tout risque d'électrocution, d'incendie, etc.:

1. Ne pas enlever les vis ni les panneaux et ne pas ouvrir le coffret de l'appareil.
2. Ne pas exposer l'appareil à la pluie ni à l'humidité.

For Canada/pour le Canada

CAUTION: TO PREVENT ELECTRIC SHOCK, MATCH WIDE BLADE OF PLUG TO WIDE SLOT, FULLY INSERT
ATTENTION: POUR EVITER LES CHOCS ELECTRIQUES, INTRODUIRE LA LAME LA PLUS LARGE DE LA FICHE DANS LA BORNE CORRESPONDANTE DE LA PRISE ET POUSSER JUSQU'AU FOND

REPRODUCTION OF LABELS (Except for Canada & USA)

1 CLASSIFICATION LABEL, PLACED ON REAR ENCLOSURE

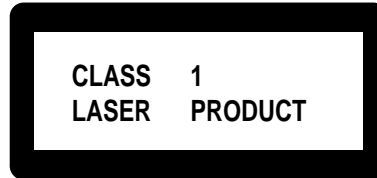

2 WARNING LABEL, PLACED INSIDE THE UNIT

CAUTION: Invisible laser radiation when open and interlock failed or defeated. AVOID DIRECT EXPOSURE TO BEAM. (e)

WARNING: Osynlig laserstrålning när denna del är öppnad och spårren är urkopplad. Betrakta ej strålen. (s)

ADVARSEL: Usynlig laserstrålning ved åbning, når sikkerhedsafbrydere er ude af funktion. Undgå udsættelse for stråling (d)

VARO: Avattaessa ja suojalukitus ohitettaessa olet alltiina näkymättömälle lasersäteilylle. Älä katso säteeseen. (f)

IMPORTANT FOR LASER PRODUCTS IMPORTANT POUR LES PRODUITS LASER

(For Canada & USA)

1. CLASS 1 LASER PRODUCT
2. **DANGER:** Invisible laser radiation when open and interlock failed or defeated. Avoid direct exposure to beam.
3. **CAUTION:** Do not open the top cover. There are no user serviceable parts inside the Unit; leave all servicing to qualified service personnel.

1. PRODUIT LASER CLASSE 1

2. **ATTENTION:** Radiation laser visible quand l'appareil est ouvert ou que le verrouillage est en panne ou désactivé. Eviter une exposition directe au rayon.
3. **ATTENTION:** Ne pas ouvrir le couvercle du dessus. Il n'y a aucune pièce utilisable à l'intérieur. Laisser à un personnel qualifié le soin de réparer votre appareil.

(For other countries)

1. CLASS 1 LASER PRODUCT
2. **CAUTION:** Invisible laser radiation when open and interlock failed or defeated. Avoid direct exposure to beam.
3. **CAUTION:** Do not open the top cover. There are no user serviceable parts inside the Unit; leave all servicing to qualified service personnel.

Caution: Proper Ventilation

To avoid risk of electric shock and fire and to protect from damage.

Locate the apparatus as follows:

Front: No obstructions open spacing.

Sides: No obstructions in 3 cm from the sides.

Top: No obstructions in 5 cm from the top.

Back: No obstructions in 15 cm from the back

Bottom: No obstructions, place on the level surface.

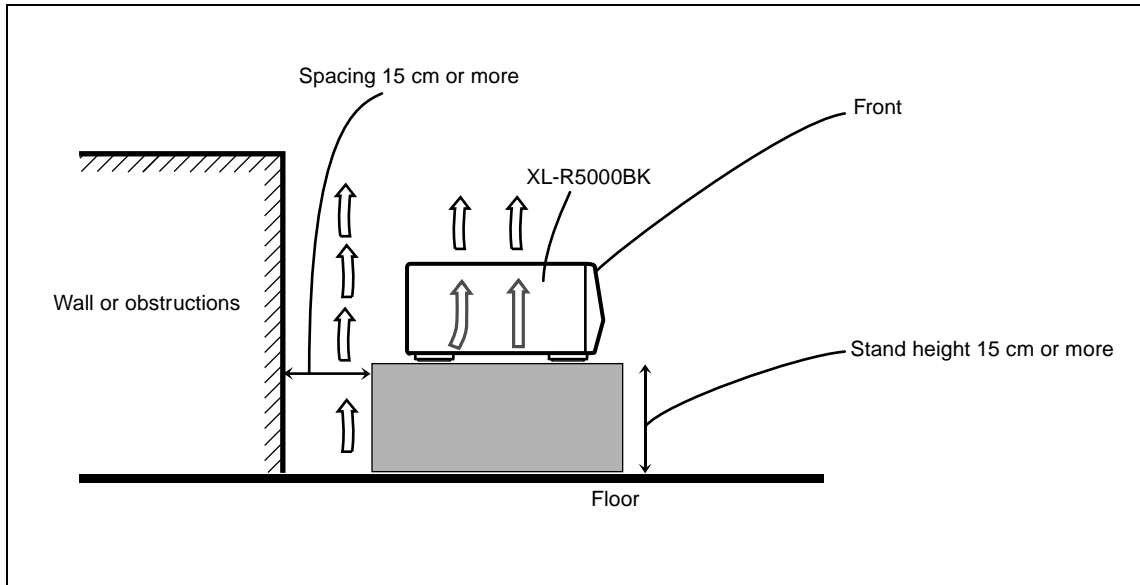

Table of Contents

| | | | |
|---|-----------|--|-----------|
| Table of Contents | 1 | COMPU LINK Function | 37 |
| Precautions | 2 | CD and CDR Messages | 38 |
| Features | 2 | Restriction on Copying Digital Material | 40 |
| Connections | 3 | SCMS (Serial Copy Management System) | 40 |
| Analog Connections | 3 | Troubleshooting | 41 |
| Digital Connections | 4 | Main Specifications | 42 |
| Names of the Parts | 5 | | |
| Main Unit | 5 | | |
| Display Window | 7 | | |
| Remote Control | 8 | | |
| Using the Remote Control | 9 | | |
| Installing the batteries | 9 | | |
| How to use the remote control correctly | 9 | | |
| Power ON/STANDBY Operations | 10 | | |
| Turning the power on and putting in standby | 10 | | |
| Listening to CDs | 11 | | |
| Continuous Playback of the 3-CD Changer (playing the loaded discs through once each) | 11 | | |
| CDR Playback Operations | 12 | | |
| Using the Remote Control to Control Playback | 12 | | |
| Direct Playback from a Specific Track | 13 | | |
| Forward and Reverse Search | 13 | | |
| Skipping Tracks | 14 | | |
| Repeat Playback | 14 | | |
| Random Playback | 15 | | |
| CD Playback Pitch Control | 15 | | |
| Disc Lock Function | 15 | | |
| Program Playback | 16 | | |
| Program playback using the remote control | 17 | | |
| Recording onto CD-R and CD-RW | 18 | | |
| Manual Recording | 18 | | |
| Synchronized Recording of 3-CD Changer Playback | 20 | | |
| Listening Edit Recording | 21 | | |
| Program Edit Recording | 22 | | |
| 3-CD Changer to CDR Recording Options | 23 | | |
| Setting the unit to perform high-speed recording | 23 | | |
| Setting the auto track spacing function | 24 | | |
| Synchronized Start Recording of External Components | 25 | | |
| Mixed Input Recording | 26 | | |
| Special Recording Edit Operations | 27 | | |
| Skipping a Recorded Track on a CD-R or CD-RW (Track Skip) | 27 | | |
| Erasing a track or tracks (ERASE function) | 27 | | |
| Erasing all the tracks (DISC ERASE function) | 28 | | |
| Finalization | 29 | | |
| Making recording possible again on a finalized CD-RW (UNFINALIZE function) | 30 | | |
| Bypassing the FS Converter (Sampling Frequency Converter) for More Efficient Digital Recording | 30 | | |
| Setting Up Synchronized Start Recording for External Digital Sources (CD, MD, and DAT only) | 31 | | |
| Resetting the Unit to the Factory Default Settings | 32 | | |
| Setting the Clock | 33 | | |
| Setting the Present Time | 33 | | |
| Timer Operations | 34 | | |
| Timer Play (wake-up play) | 34 | | |
| Timer Recording (unattended recording of the sound from a broadcast receiver or other component) | 35 | | |

Precautions

Thank you for purchasing this JVC product. Please read these instructions through carefully before starting operation to ensure that you will derive the optimum performance and a long service life from your unit.

Safeguarding against electric shocks, fire hazards and damage

- 1) A very low current will still flow even when the POWER (for Canada and U.S.A.)/⏻/ (for other countries) button is set at STANDBY. To save power and ensure safety when the unit is not going to be used for an extended period of time, disconnect the power cords from the household AC outlet. (See page 10)
- 2) Do not handle the power cord with wet hands.
- 3) To unplug the power cord from the household AC outlet, always take hold of the molded plug part and pull the plug free rather than pulling the cord.
- 4) If the power cord is damaged or found to have a disconnected wire or a contact failure, consult your dealer.
- 5) Do not bend the cord at a sharp angle, and do not pull or twist it.
- 6) Do not modify the power cord in any way.
- 7) Do not remove the screws in order to disassemble the unit, and do not touch any of the parts inside the unit.
- 8) Do not insert metallic objects into the unit.
- 9) Unplug the power cord during electrical storms.
- 10) If water should find its way inside the unit, unplug the power cord from the outlet, and consult your dealer.
- 11) Do not install the unit in a poorly ventilated location.

Installation

- 1) Avoid placing the unit on or adjacent to an amplifier. This is to prevent the humming caused by the unit's proximity to some types of amplifiers. Move the unit where it will not be affected by the amplifier.
- 2) Avoid installing the unit where the ambient temperature will exceed 35 °C (namely, in direct sunlight, near a heating appliance, etc.) or drop below 5 °C, where it is very humid or dusty, or where the unit will be subject to vibration.
- 3) The unit may not function properly if it is moved suddenly from a cold place (0 °C) to a warm place since condensation may form inside the unit. In such a case, leave the unit standing for about couple of hours, after which time it should function properly.

Disc care

- Storing CDs
 - Always ensure that each CD is stored in its own case.
 - Do not place CDs in direct sunlight, near a heating appliance or any other location which is susceptible to high temperatures.
- If cellophane tape, an adhesive sticker or some other form of glue is present on the label side, clean it off before use.
- Do not stick adhesive labels or write anything on a CD.
- Do not bend CDs.
- Do NOT insert shaped CDs, such as CDs in a heart, flower or other shape, because their shape does not match the shape of the CD tray, and using them will give rise to malfunctioning.

Cleaning the cabinet

Never use benzine or paint thinners to clean the cabinet as they may mar the unit's surface finish.

Features

All of the functions and conveniences of having a 3-CD changer and CDR in a single combination deck

- 3-CD changer compatible with CD-RW
- CDR capable of performing high speed (2x) recording of discs loaded in the 3-CD changer
- Optical digital/analog input and output with an additional input for microphone
- Sampling frequency converter capable of converting digital signals with sampling frequency of 32 kHz and 48 kHz to digital signals with a sampling frequency of 44.1 kHz for quality recording from a variety of sources
- No sampling frequency conversion of 44.1 kHz signals for optimal recording of CDs
- Mixing and recording of the 3-CD changer playback and either microphone input or an externally input source, or even the microphone input and the externally input source
- Many convenient recording options including: one-button CD and single track recording, Listening and Program Edit recording, manual recording, synchronized start recording, and mixed input recording
- CD playback pitch control that can adjust the speed of play up to 12% faster or slower than the normal speed to alter the pitch for singing along to or other customized uses
- Timer playback and timer recording that can be set for one-time or everyday operation
- OPC (Optimize Power Control), strength adjustment performed for best possible recording onto CD-R and CD-RW media

Types of Discs Compatible with the Unit

The following disc formats can be used in the CDR for recording.



In addition to the marks shown above, the phrases shown below or their equivalent should also be present somewhere on the packaging or accompanying documentation:

**FOR CONSUMER
FOR CONSUMER USE
FOR MUSIC USE ONLY**

Discs that cannot be used for recording are as follows:

- Discs bearing marks other than those shown above
- Discs intended for professional use and/or marked "FOR PROFESSIONAL USE ONLY"
- Discs intended for recording computer data

In addition to the two disc formats shown above, the following disc format can also be played in either the 3CD changer or CDR.



Notes

- Although the CDR can play all 3 types of discs at any time, the 3-CD changer can only play CD-R and CD-RW after they have been finalized. For more information on finalization of CD-R and CD-RW, see page 29.
- The unit can playback audio recorded in CD-G, CD-EXTRA and CD-Text discs.
- If a CD-R or CD-RW has been recorded using a personal computer, playback is only possible if the disc is recorded in the CD Audio format.

Connections

Do not turn on the power until all the connections have been completed.

Analog Connections

Use the accessory pin cables to connect this unit's LINE connectors with the TAPE/CDR connectors on the receiver, etc.

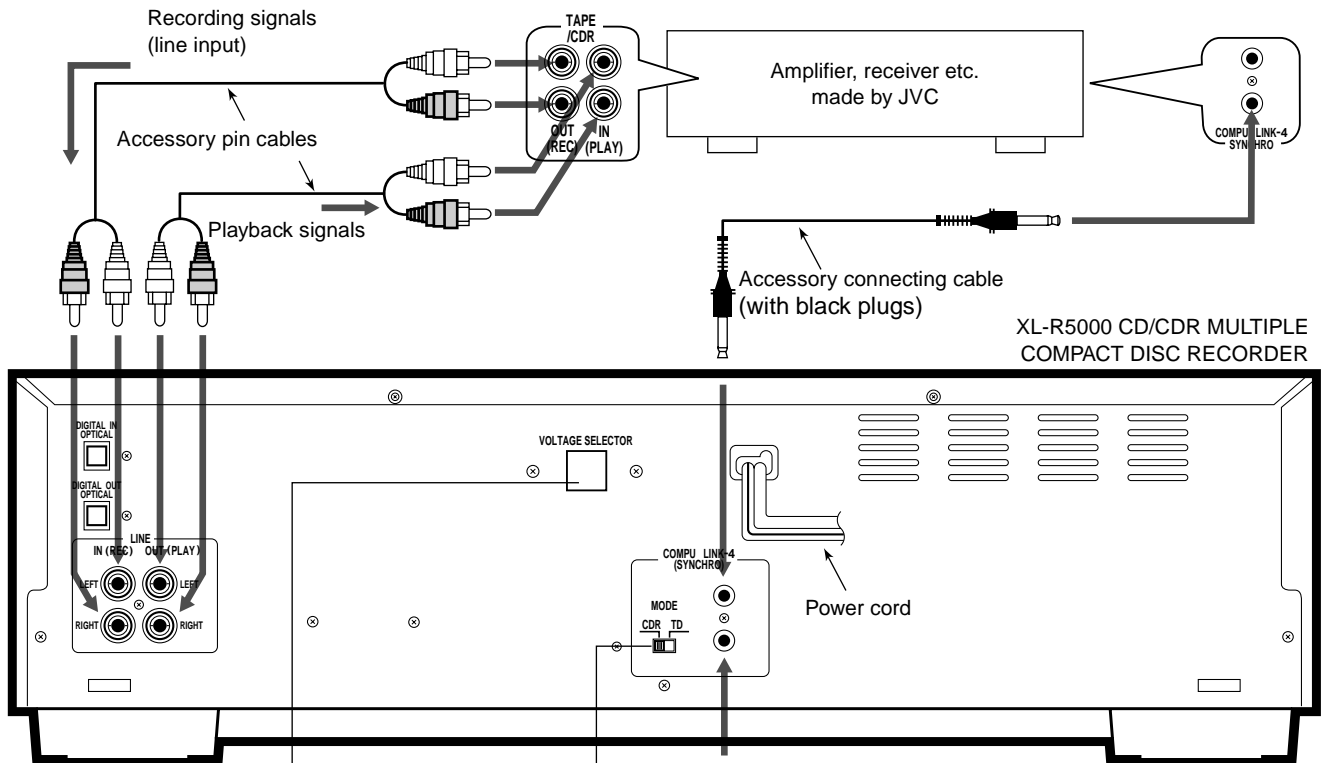

Units have a voltage selector excluding units for Canada, Europe, and U.S.A.

MODE switch

Selecting the MODE switch position

- When connected with CDR input/output terminals of the amplifier or receiver
- When connected with TAPE input/output terminals of the amplifier or receiver



- For further details on the COMPU LINK function, see page 37.

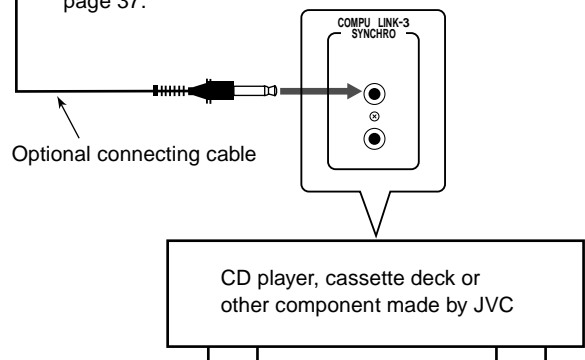

Note

- Before selecting the COMPU LINK-4 mode (CDR or TD), disconnect the power cord from the power outlet to turn off the power. The function will not be set if it is selected while the power is on. Alternatively, when the COMPU LINK-4 mode (CDR or TD) is selected while the power is on, disconnect the power cord and then re-connect it.
- Misconnections can be avoided by using the white plugs on the accessory pin cables for the LEFT channel and the red plugs for the RIGHT channel.
- Insert the plugs all the way in. Incomplete connections may cause noise.
- When plugging the power cord into the AC outlet, be sure to match the width of the plug blades with the outlet.

Digital Connections

Before proceeding, check whether the optical digital cable can be connected.

- Connect a receiver or amplifier with digital audio capability to the DIGITAL OPTICAL connectors on this unit.
- One connecting cable is used to transmit the stereo signals (L/R) as a digital signal.

- If analog audio connections are also being made, try to use the digital connectors on the receiver or amplifier that are labeled the same way as the analog connectors.
- Before purchasing an optical digital cable (optional), make sure that the cable in question can be connected to the amplifier, etc.
- Do not bend the optical digital cable at a sharp angle.
- When the power is turned on, the inside of the connector lights up red. This light is for sending the digital signals. Although this light will not harm your eyes, keep the protective cap in place if the connector is not going to be used.

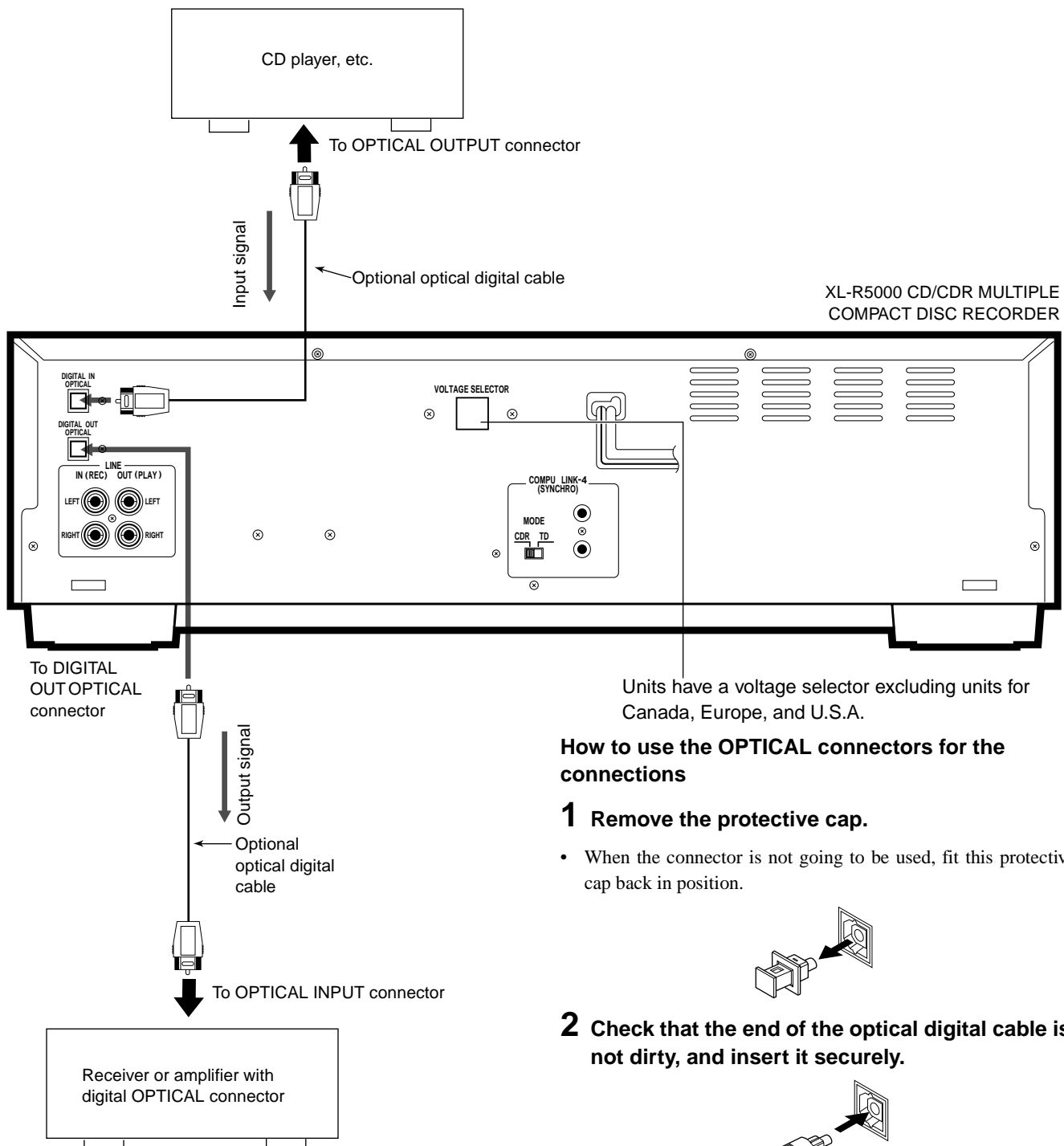

How to use the OPTICAL connectors for the connections

1 Remove the protective cap.

- When the connector is not going to be used, fit this protective cap back in position.

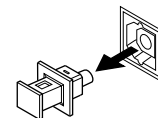

2 Check that the end of the optical digital cable is not dirty, and insert it securely.

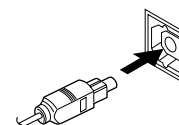

Names of the Parts

Main Unit

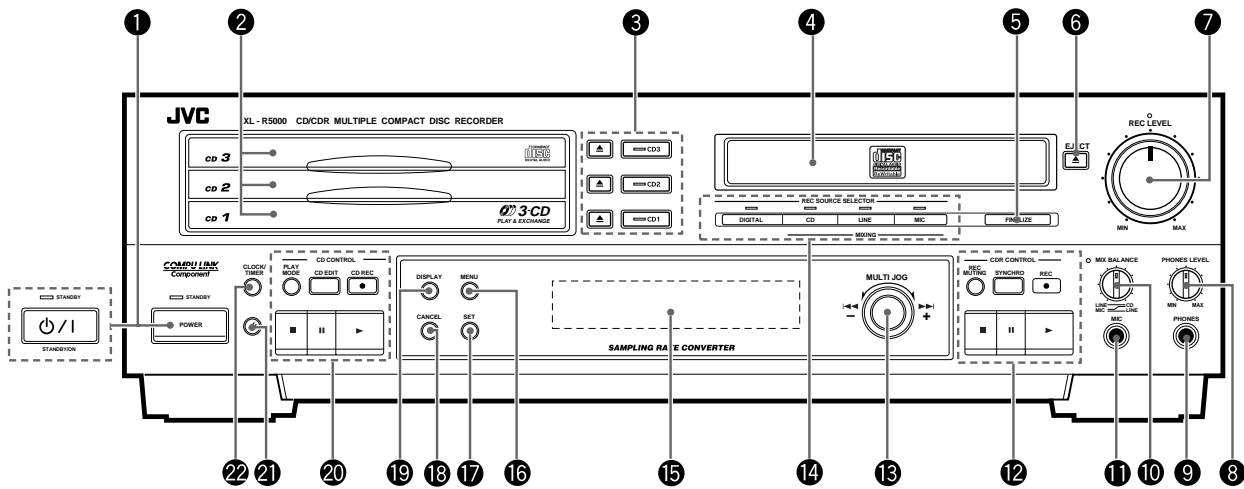

1 POWER button and STANDBY lamp (for Canada and U.S.A)

⏻/⏪ button and STANDBY lamp (for other countries)

Press to turn the power on or to put in standby. When the unit is in standby, the STANDBY lamp is lit. (See page 10.)

2 CD trays 1, 2, and 3 (numbered from bottom to top)

Load CDs on these trays for 3-CD changer playback. (See page 11.)

3 Disc tray selector buttons (with current selection lamp) and ▲ (eject) buttons

Press to select one of the CDs loaded in the 3-CD changer. The lamp on the button lights to indicate the currently selected tray. Use the ▲ (eject) buttons to open and close the corresponding disc trays. (See page 11.)

4 CDR disc tray

Load a recordable CD-R or CD-RW in this tray for recording. CD playback is also available using this tray.

5 FINALIZE button

Press to finalize a CD-R or CD-RW disc when recording on the disc has been completed. (See page 29.)

6 EJECT ▲

Press to open and close the CDR disc tray.

7 REC LEVEL control and lamp

Use to adjust the level of the source signal being recorded. (See page 18 and 25.)

8 PHONES LEVEL control

Use to adjust the level of the volume being output to connected headphones (not supplied).

9 PHONES connector

Use to connect headphones (not supplied) to this unit.

10 MIX BALANCE control and lamp

Use to control the mixing levels of two independent sources being recorded. The lamp is lit during mixed recording. (See page 26.)

11 MIC connector

Use to connect a microphone (not supplied) to this unit. (See page 18.)

12 CDR CONTROL operation buttons

REC MUTING: Press to record silence during a recording. (See page 19.)

SYNCHRO: Press to select synchronized start recording. (See page 25.)

REC ●: Press to put this unit in record pause mode for manual recording. (See page 18 and 26.)

■ (stop): Press to stop recording or play of the CDR. (See page 12 and 19.)

⏪ (pause): Press to pause play and recording. (See page 12.)

▶ (play): Press to start play or recording (in record pause mode) of the CDR. (See page 12 and 19.)

13 MULTI JOG dial

Depending on the mode, use to skip forward or backward through tracks on a CD, change the clock settings, or select setting options. (See pages 14, 16, 23, and 33.)

14 REC SOURCE SELECTOR buttons

Use to select the type of source to be recorded. (See pages 18 and 26.)

15 Display window

Displays the operation modes and other system information. (See page 7.)

16 MENU button

Press to enter a menu option.

17 SET button

Press to enter a selection.

18 CANCEL button

Press to cancel an operation.

19 DISPLAY button

Press repeatedly to change the type of information that appears in the display window information display.

20 CD CONTROL operation buttons

PLAY MODE: Press repeatedly to select one of the play modes for the 3-CD changer. (See page 15 and 16.)

CD EDIT: Press to select either the Listening Edit or Program Edit recording modes. (See page 21 and 22.)

CD REC: Press to perform synchronized recording of the currently selected CD in the 3-CD changer. (See page 20 and 21.)

■ (stop): Press to stop play of the selected disc in the 3-CD changer. (See page 11.)

|| (pause): Press to pause play of the selected disc in the 3-CD changer. (See page 11.)

▶ (play): Press to start play of the selected disc in the 3-CD changer. (See page 11.)

21 Remote control sensor

Receives commands from the remote control.

22 CLOCK/TIMER button

Use to set the time. (See page 33.)

Display Window

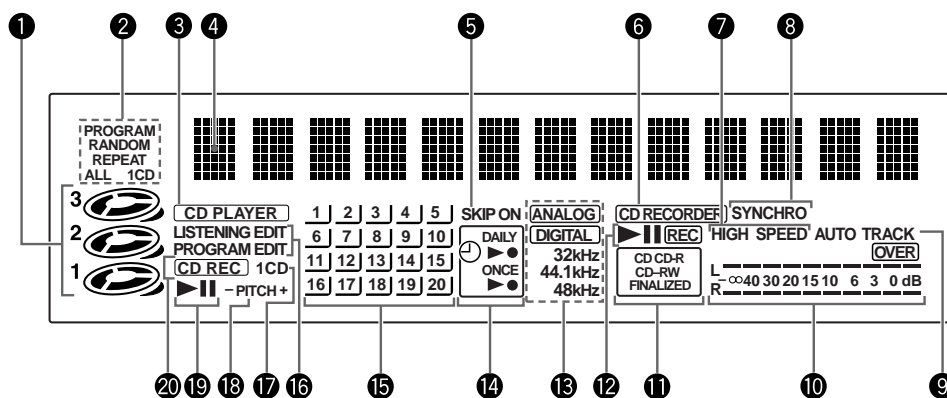

1 CD numbers and play status displays

Indicate whether discs are loaded in any of the 3-CD changer disc trays, which disc is currently selected, and the operation status of the current disc. (See page 12.)

2 PLAY MODE indicators

Light according to which play mode has been selected. (See page 14 to 16.)

3 CD PLAYER indicator

Lights when the 3-CD changer is selected for play.

4 Information display

Displays track, time, and operation information.

5 SKIP ON indicator

Lights when the currently selected disc contains SKIP TRACK markers.

6 CD RECORDER indicator

Lights when the CDR has been selected for play or recording.

7 HIGH SPEED indicator

Lights when the high speed (2x) dubbing function is being performed. (See page 23.)

8 Synchronized recording indicators

Light to indicate synchronized recording is on. (See page 20.)

9 AUTO TRACK indicator

Lights when automatic track marking has been turned on. (See page 18.)

10 Level meter

Indicates the level of the right and left channels during playback and recording operations. When the input signal exceeds 0 dB, the OVER indicator lights. (See page 18.)

11 Disc format indicators

Light to indicate the type of disc that is loaded in the CDR.

12 CDR deck operation indicators

Light to indicate the operation mode of the CDR.

13 Recording type indicators and sampling frequency indicators

Light to indicate whether the recording is analog or digital. During digital recording, the appropriate frequency indicator lights to indicate the sampling frequency of the source being recorded. (See page 18.)

14 Timer operation indicators

Indicate that a Timer Play or Timer Recording function has been set, and whether it is set for everyday or one-time operation. (See pages 33.)

15 Music calendar

Indicates the number of tracks on the currently selected CD or CDR, and the track on the disc that is being played or recorded.

16 EDIT recording indicators

Indicates whether the Listening Edit or Program Edit functions are being performed. (See pages 21 and 22.)

17 1CD indicator

Lights during synchronized recording. (See page 20.)

18 PITCH (+/-) indicators

Indicate that the pitch of CD play has been adjusted in one direction or the other. (See page 15.)

19 3-CD changer operation indicators

Light to indicate the operation mode of the 3-CD changer.

20 CD REC indicator

Indicates the CD(s) loaded in the 3-CD changer is being recorded by the CDR.

Remote Control

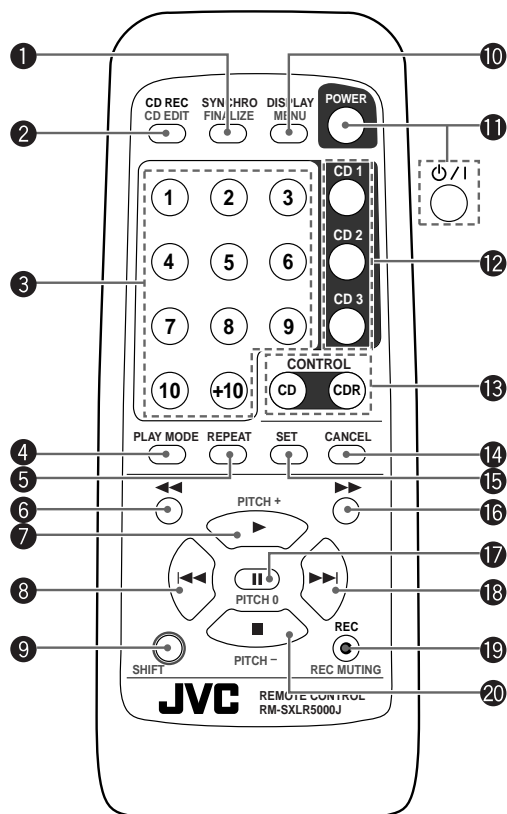

When performing the procedures in this manual, the buttons on the remote control have the same function as the corresponding buttons on the main unit.

1 SYNCHRO/FINALIZE button

Press to select synchronized start recording. (See page 25.)
When SHIFT is pressed down, press to start finalization of a CD-R or CD-RW. (See page 29.)

2 CD REC/CD EDIT button

Press to start the CD REC function. (See pages 21.)
When SHIFT is pressed down, press repeatedly to select Listening Edit or Program Edit functions. (See pages 21 and 22.)

3 Number buttons

Press to select a track for playback. (See page 13.)

4 PLAY MODE button

Press repeatedly to select a play mode for the 3-CD changer. (See page 15.)

5 REPEAT button

Press repeatedly to select one of the repeat play modes. (See page 14.)

6 ◀◀ (reverse) button

Press to perform fast reverse search of the currently selected CD. (See page 13.)

7 ▶ (play)/PITCH + button

Press to play the currently selected CD. (See page 10 and 12.)
When SHIFT is pressed down, press to raise the pitch of CD playback. (See page 15.)

8 ◀◀ (skip reverse) button

Press to skip back to the beginning of previous tracks. (See page 14.)

9 SHIFT button

Press down in conjunction with other buttons on the remote control to make use of their secondary functions.

10 DISPLAY/MENU button

Press repeatedly to change the type of information that appears in the display window information display.
When SHIFT is pressed down, press to enter a menu option.

11 POWER (for Canada and U.S.A.)/ ⏻ (for other countries) button

Press to turn the power of this unit on or to put in standby. (See page 10.)

12 CD1, CD2, and CD3 disc selection buttons

Use to select one of the discs loaded in the 3-CD changer. (See page 10, 12, and 13.)

13 CD and CDR deck selection buttons

Press to change the function of this unit to the 3-CD changer or CDR. (See page 12.)

14 CANCEL button

Press to cancel an operation.

15 SET button

Press to enter a selection.

16 ▶▶ (forward) button

Press to perform fast forward search of the currently selected CD. (See page 13.)

17 || (pause)/ PITCH 0 button

Press to pause playback of the currently selected disc. (See page 12.)

When SHIFT is pressed down, press to restore the pitch level of CD playback. (See page 15.)

18 ▶▶| (skip forward) button

Press to skip forward to other tracks on the disc. (See page 14.)

19 REC ●/REC MUTING button

Press to put this unit in the record pause mode. (See page 18 and 26.)

When SHIFT is pressed down, press to record silence during a recording. (See page 19.)

20 ■ (stop)/PITCH - button

Press to stop playback of the currently selected disc. (See page 12.)
When SHIFT is pressed down, press to lower the pitch level of CD playback. (See page 15.)

Using the Remote Control

Installing the batteries

- 1 Press down on the point shown by the arrow at the top of the compartment cover, and pull up the cover to open the compartment.

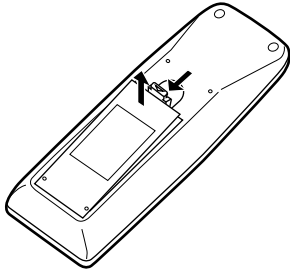

- 2 Place the two accessory AA (15F), R6, SUM-3 batteries in the remote control making sure to align the polarity markings (“+” and “-”) inside the compartment and on the batteries.

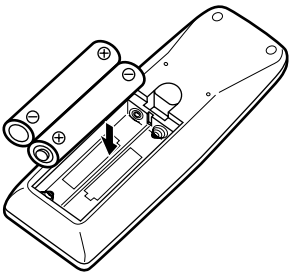

- 3 Place the cover over the compartment, and press down lightly.

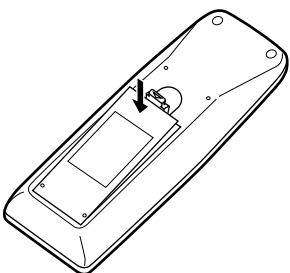

How to use the remote control correctly

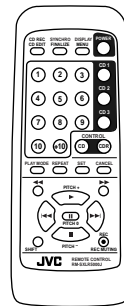
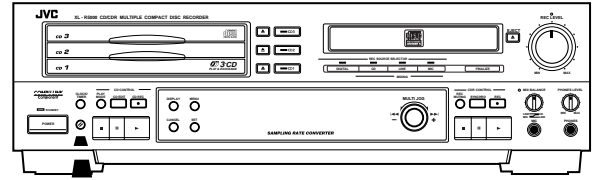

- Point the remote control correctly at the remote control sensor on the main unit when pressing the buttons.
- The remote control can be operated at a distance of up to 7 meters or so from the remote control sensor. This distance will be less if the remote control is operated from a position which is not directly in front or on the same level as the main unit.
- When the distance over which the remote control can be operated starts to drop, it means that the batteries are nearing the end of their service life.
- Replace both batteries (AA (15F), R6, SUM-3) with fresh units.
- The dry batteries provided with the unit are for operational check purposes. Replace them with fresh units at the earliest opportunity.
- Do not drop the remote control or subject it to strong impact.
- In order to ensure that the remote control does not fail to operate, avoid operation under the following conditions:
 - When the remote control sensor is exposed to direct sunlight or other intense sources of light
 - When objects in front of the remote control sensor block the transmission of signals from the remote control

Power ON/STANDBY Operations

Turning the power on and putting in standby

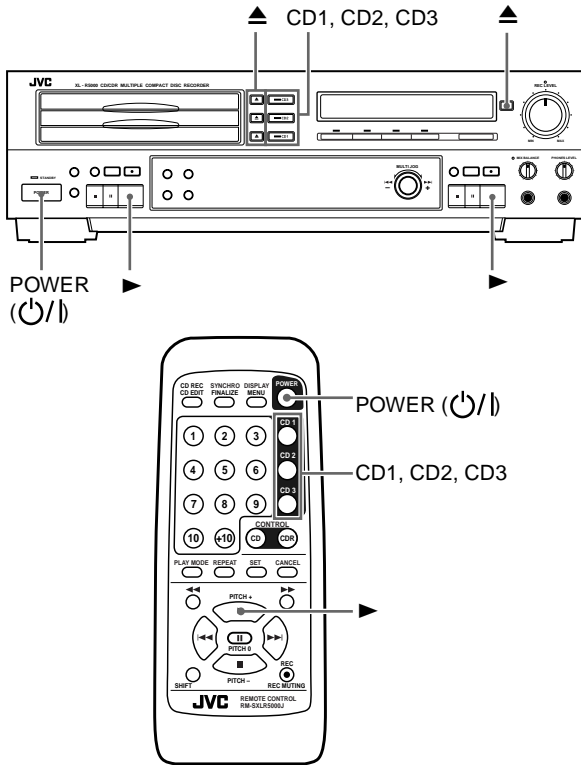

- The clock display appears in the display window. It flashes if the clock has not been set.
- The power can only be put to standby by pressing the POWER (for Canada and U.S.A.)/POWER (for other countries) button pressing.

If the POWER (for Canada and U.S.A.)/POWER (for other countries) button is pressed during recording, the standby lamp flashes while the unit brings the operation to a stop. Once the unit has been put in the stop mode, the unit is put in standby and the standby lamp lights steady. During this time, there is no effect if any of the buttons on the front panel or remote control (including POWER (for Canada and U.S.A.)/POWER (for other countries)) are pressed.

To turn on the power by pressing a function button

When the power is switched to STANDBY, it can be turned on and a function selected simply by pressing one of the buttons shown in the figure below

| | Function | Operation |
|---|----------|---|
| Main unit Remote control | CD | The function is set to CD. The CD PLAYER indicator lights. If one of these buttons is pressed when a CD is on the corresponding CD tray, continuous play starts from the CD tray which corresponds to the button pressed. These buttons do not function during program and random play modes. |
| Main unit (CD control) | CD | The function is set to CD. The CD PLAYER indicator lights. |
| Main unit (CDR control) | CDR | The function is set to CDR. The CD RECORDER indicator lights. |

To turn on the power

Press the POWER (for Canada and U.S.A.)/POWER (for other countries) button on the front panel or remote control.

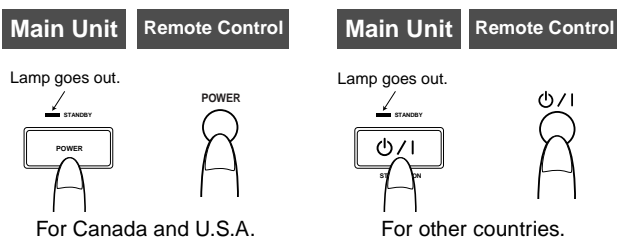

- The currently selected function appears in the display window.

To put the power to standby

Press the POWER (for Canada and U.S.A.)/POWER (for other countries) button on the front panel or remote control.

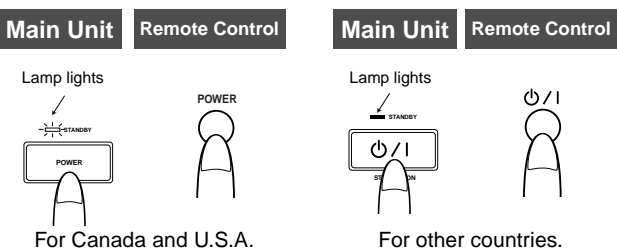

- When the ► button for either the 3-CD changer or CDR is pressed, the power is turned on and the corresponding tray is selected. If a disc is loaded in the selected tray, playback begins. If the power has been turned on, pressing ► on the remote control selects the last selected function (3-CD changer or CDR) and starts playback of the disc loaded in the selected tray.
- When one of the 3-CD changer ▲ (eject) buttons or the CDR EJECT ▲ button is pressed, the power is turned on and the tray opens, but the currently selected function (3-CD changer or CDR) does not change.
- If the main power is turned off or if the AC power cord is unplugged from the wall outlet for longer than an hour, the internal clock, program etc. of this unit may be reset. When this occurs, please set the clock (and timer functions) again.

Listening to CDs

Continuous Playback of the 3-CD Changer (playing the loaded discs through once each)

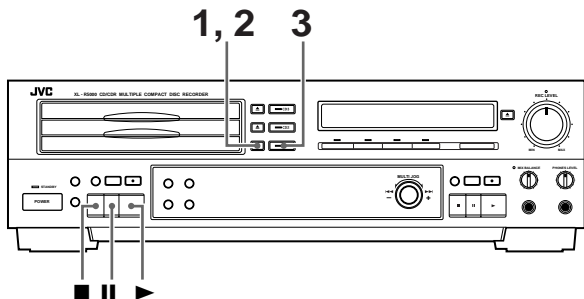

Example: When starting playback at CD1.

1 Press the CD1 ▲ button to open the CD tray.

- The power comes on, and the CD1 tray opens.

2 Load a CD in position and close the tray.

Place the CD with its label side facing up.

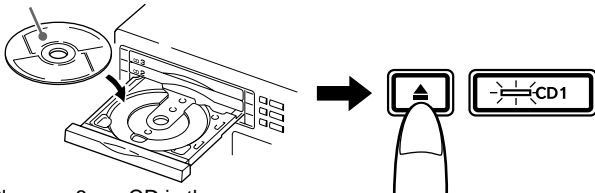

Place an 8-cm CD in the center cutout.

- While referring to steps 1 and 2, press the CD2 ▲ button and CD3 ▲ button, and load CDs in position on the CD2 and CD3 trays.
- While the tray concerned is being opened or closed or while the CD selection is being changed internally, no operation will result even if the ▲ button is pressed.
- Disc trays cannot be opened if recording is being performed by the CDR.

3 Press the CD1 button.

- The function is set to CD, and CD1 playback starts from track 1.

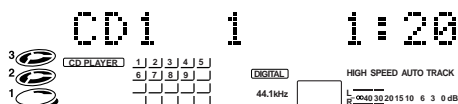

- The numbers of the tracks which have been played are cleared from the music calendar.
- In this example, playback proceeds through all the tracks on CD1, CD2, and CD3, and stops automatically after the last track on CD3. This pattern changes depending on the first disc selected as described in the following section.

When one or more CDs are already on the trays.

- Press the CD1, CD2 or CD3 button corresponding to the CD concerned directly. Continuous play starts with the CD corresponding to the number of the button pressed. If the button is pressed when the power is in standby, continuous play starts when the power is next turned on.
- **When play starts from CD2**
The CDs are played in the sequence of CD2 → CD3 → CD1, after which play is automatically stopped.
- **When play starts from CD3**
The CDs are played in the sequence of CD3 → CD1 → CD2, after which play is automatically stopped.
If one of the trays does not contain a CD, play skips to the CD in the next tray in the sequence.

Note

The CD1, CD2, and CD3 buttons do not function during program and random play modes.

Playing CDs using the ► button

Press the CD CONTROL ► (play) button to select the 3-CD changer function. This automatically starts playback of the disc in the selected tray.

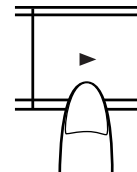

- The selected disc tray is indicated by the red “▶” appearing to the immediate right of the CD number displays.

Stopping CD playback

To stop playback at any time

- When the CD CONTROL ■ (STOP) button is pressed, playback stops and the total track number and play time appear in the display.

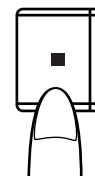

- When all the tracks on a CD have been played through, playback will stop automatically.

To stop playback temporarily

- If the || (pause) button is pressed, playback is paused. When the ► button is pressed, playback is resumed from the place where it was paused.

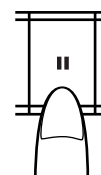

- Pressing the || (pause) button during synchronized recording has no effect.
- During mixed recording, recording continues even if the CD CONTROL || (pause) or CD CONTROL ■ (STOP) button is pressed.

Concerning the CD numbers and play status display

The display shows for each CD tray whether or not a CD has been inserted as well as the play status of the CD.

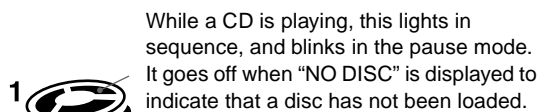

The CD on the CD tray for which this has lighted is selected.

CDR Playback Operations

The CDR section can be used to play back CDs, CD-R, and CD-RW.

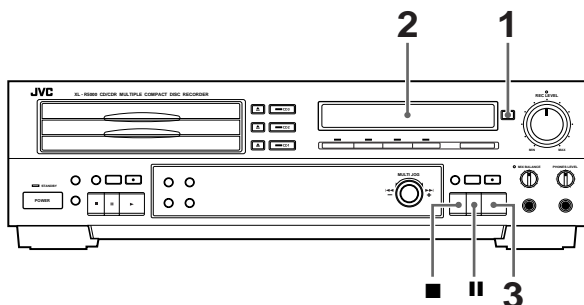

1 Press the EJECT ▲ button to open the CDR disc tray.

2 Load a disc in position and close the tray.

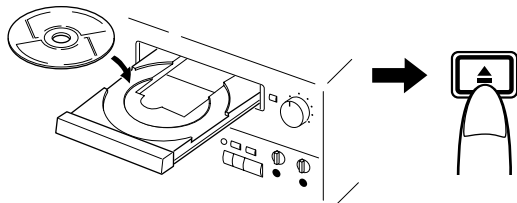

- When a CD-R or CD-RW is loaded in the CDR for the first time, OPC (Optimize Power Control) is performed. This procedure requires anywhere from 10 seconds up to a minute to perform. Once OPC has been performed, the unit stores the information for that disc in memory (occasionally some older data will be erased and OPC may need to be performed again in these cases).
- When a CD-R or CD-RW is loaded in the CDR, the unit determines the format of the disc, whether it is finalized or not, and then determines whether OPC (Optimize Power Control) has been performed for the disc or not. At this time, OPC is also performed if necessary. The length of time required for this unit to perform the necessary operations depends on the type and status of the disc.
- When "UPDATE OPC" is displayed, the **REC** indicator lights and the ► and disc format indicator flashes.

3 Press the CDR CONTROL ► button to select the CDR function and start playback at track 1.

- Playback is automatically stopped at the end of the last track on the disc.
- Unfinalized CD-R and CD-RW may be played back using the CDR. Unfinalized discs cannot be played back using the 3-CD changer.

To stop CDR playback

- Pressing the CDR CONTROL ■ (stop) button at any point during playback stops the playback and the total track number and play time appear in the display.

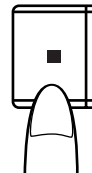

- When an unfinalized CD-R or CD-RW is loaded in the CDR and the EJECT ▲ button is pressed to open the CDR disc tray, "FINALIZE?" appears in the display window. If you do not wish to finalize the disc at this time, press the EJECT ▲ button again. For more information on finalization, see page 29.

To stop CDR playback temporarily

- Pressing the CDR CONTROL || (pause) button at any time during playback pauses the playback. Press the ► button to resume playback.

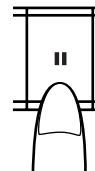

- When playback is paused, the || indicator lights in the display.

Note

Before finalization of the disc is performed, when you playback of the disc is started from the stop mode or at a track that is skipped forward or reverse to etc., the very beginning of the track may cut.

Using the Remote Control to Control Playback

The buttons on the remote control can be used to control playback of both the 3-CD changer and CDR. When using the remote control, be sure to point the remote control correctly at the remote control sensor on the main unit when pressing the buttons.

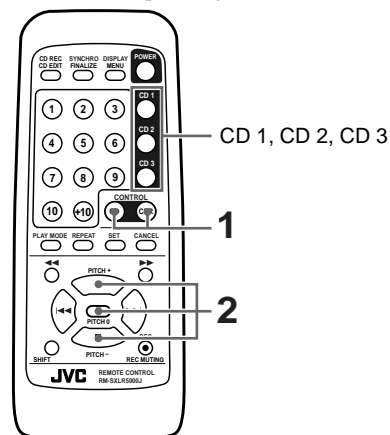

1 Press the CD or CDR button to select the function.

- CD button:** To control discs in the 3-CD changer
- CDR button:** To control the disc in the CDR

- Pressing the CD 1, CD 2, or CD 3 buttons automatically sets the main unit to the CD function and starts playback of the disc in the selected tray.
- When the CD function is selected, the CD PLAYER indicator lights in the display. When the CDR function is selected, the CD RECORDER indicator lights.

2 Press the command button of the operation you want to perform.

- The buttons on the remote control perform the same operation as those on the main unit.
- The function is applied to the 3-CD changer or CDR function depending on which function is currently selected.

Direct Playback from a Specific Track

CD playback can be started from a specific track by pressing the corresponding number button(s) on the remote control.

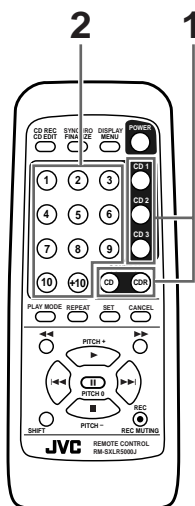

1 Press the function button corresponding to the CD whose track is to be heard.

For a CD in the 3-CD changer For a CD in the CDR

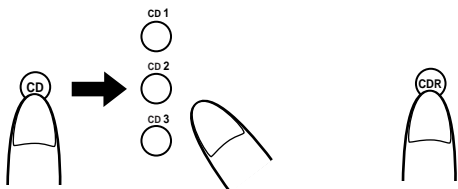

2 Press the number button(s) of the track you want to hear.

The track number corresponding to the buttons pressed appears in the display window, and direct play starts.

To select tracks 1 through 10

Press the number button 1 to 10 corresponding to the track.

To select tracks 11 or above

First press the +10 button, and then press one of the number buttons 1 to 10.

Example: Track 15

Press +10 followed by 5.

Example: Track 20

Press +10 followed by 10.

Example: Track 25

Press +10 twice followed by 5.

Another track can be selected even during play.

Press the number button(s) corresponding to the track which is to be heard. The display now changes to indicate the corresponding track number, and play starts from the beginning of the track concerned.

To select a track of a CD on another tray, repeat the above procedure.

- Direct play cannot be initiated by pressing the +10 button alone: this button must be used with one of the number buttons 1 to 10. Neither can direct play be initiated during program or random play modes.

Forward and Reverse Search

The ◀◀ (reverse) and ▶▶ (forward) buttons on the remote control can be used to find a particular location on a CD. Press down the button corresponding to the direction you want during CD playback. Release the button when the location you want to hear is reached.

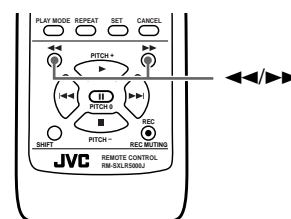

- During forward or reverse search, the playback will sound garbled. However, normal playback will resume when the search button is released.

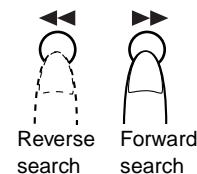

- If playback is paused when a search is performed, there is no sound heard during the search. When the search is complete the pause mode is resumed.
- When forward and reverse searching are performed during playback of the unfinalized disc, the display and/or the searching function may not operate properly depending on the type of disc that you are using.

Skipping Tracks

To skip forward or backward to different tracks on the currently selected CD, use the MULTI JOG dial on the unit or the ◀◀ or ▶▶ buttons on the remote control.

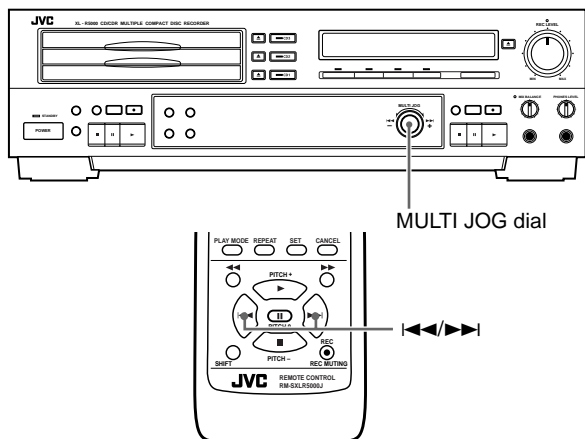

- When the last track on a CD loaded in the 3-CD changer is advanced to the next track, playback moves to the first track on the next CD. There is no effect when the last track on the CD loaded in the CDR is advanced.

Main Unit

- Turn counterclockwise one notch to return the beginning of the current track, or keep turning until the track number you want appears in the display.
- Turn clockwise one notch to move to the beginning of the next track, or keep turning until the track you want appears in the display.

Remote Control

- Press the ◀◀ button once to return to the beginning of the current track and press repeatedly until the track you want appears in the display.
- Press the ▶▶ button once to move to the beginning of the next track, and press repeatedly until the track you want appears in the display.

Repeat Playback

The repeat play mode can be selected by pressing the REPEAT button on the remote control when the function is set to CD. Each time the REPEAT button is pressed, a different display appears in the display window.

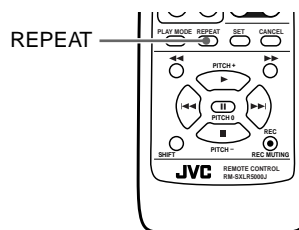

During normal play mode

REPEAT ALL : Repeat playback of all of the CDs loaded in the 3-CD changer.



REPEAT 1CD : Repeat playback of the CD currently playing



REPEAT 1 : Repeat playback of the track currently playing



Repeat off (normal display appears)

During program and random play modes

REPEAT ALL : Repeat random playback of all of the CDs loaded in the 3-CD changer or repeat playback of the entire program.



REPEAT 1 : Repeat playback of the track currently playing



Repeat off (normal display appears)

- Repeat playback operations cannot be performed during CD REC and CD EDIT recording operations.
- Play is repeated in the selected mode when the CD1, CD2 or CD3 button or ▶ button (or the ▶ button on the main unit) is pressed.
- Repeat playback operations are not possible for the disc loaded in the CDR.

Random Playback

The random play mode can be selected by pressing the PLAY MODE button repeatedly on the main unit or remote control when the function is in the CD stop mode.

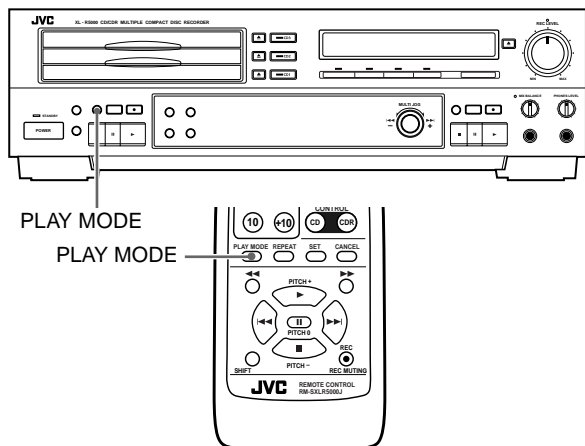

- Random playback of tracks on the disc loaded in the CDR cannot be performed.
- Random play is started by pressing the ► button.

To release the random play mode

Press the PLAY MODE button in the stop mode repeatedly until the RANDOM indicator is cleared from the display.

CD Playback Pitch Control

There are three CD pitch control buttons on the remote control that can be used to vary the speed of CD playback up to 12% faster or slower than the standard playback speed. This function can be useful in changing the pitch when adding vocals to a recording using the microphone input or when matching the playback speed of the CD with another source.

To adjust the pitch of the source CD during playback

While pressing down the SHIFT button, press PITCH+ to raise the pitch or PITCH- to lower the pitch of CD playback. Each press of the button raises or lowers the playback speed in 1% steps.

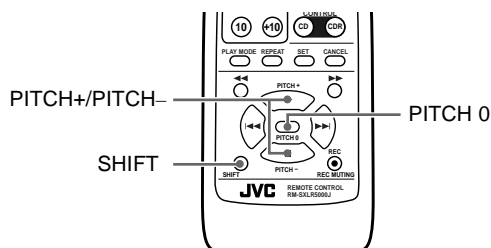

- To restore the playback speed to normal, press PITCH 0 while pressing down the SHIFT button.
- The adjusted playback speed can only be recorded using analog recording functions such as mixed recording.
- Even if the pitch has been adjusted, when digital synchronized recording is performed, the pitch is automatically restored to 0 before recording begins.

- When the speed of CD playback is changed using the pitch control buttons, there is no output from the DIGITAL OUT OPTICAL connector.

Disc Lock Function

The Disc Lock function can be used to make it impossible for children or anyone else to take CDs out or load new ones for both 3 CD changer and CDR.

This function is suitable for ensuring that timer play or timer recording functions can be performed correctly.

- When the power is in standby, press the ▲ button of CD1 while holding down the ■ button on the front panel. “TRAY LOCKED” appears for 3 seconds, and it is no longer possible to take out or load CDs.

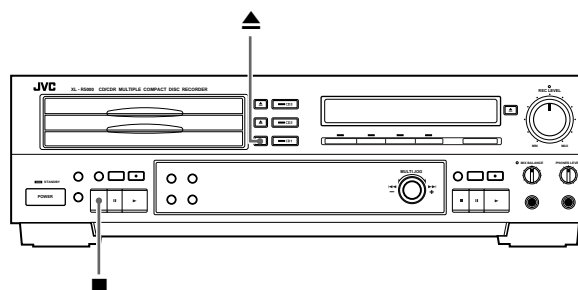

To cancel the Disc Lock function.

Repeat the same step. “TRAY UNLOCKED” appears for 3 seconds, and the Disc Lock function is canceled.

Please note that the disc lock function is canceled if the main power is turned off or if the AC power cord is unplugged from the wall outlet.

Program Playback

Up to 32 tracks can be programmed. Any tracks on CD1, CD2 and CD3 can be selected.

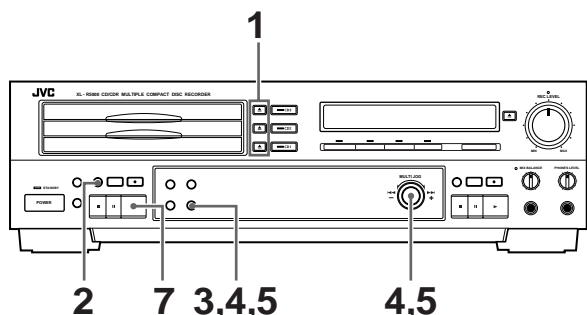

1 Insert CDs that contain tracks to be programmed.

- Tracks on a CD which has not been inserted cannot be played even when they have been programmed. Operation will simply move on to the next step in the program.

2 Press the PLAY MODE button while the unit is in the CD stop mode to select PROGRAM.

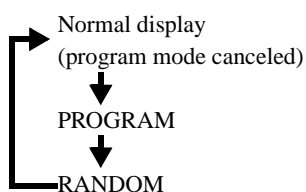

- “PG NO PROGRAM” appears in the display when no program has been made.

3 Press the SET button.

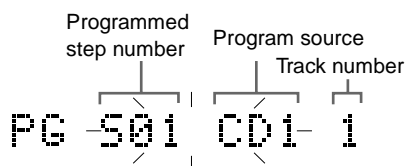

4 Select and enter the program source.

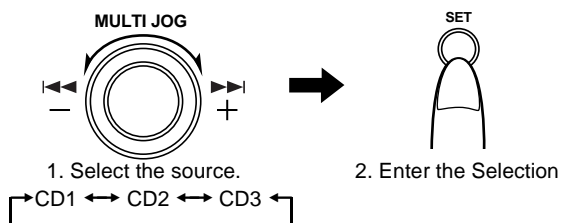

- The source can be selected in the reverse direction by turning the MULTI JOG dial counterclockwise.
- When the SET button is pressed, the programming step and track number flash.
- A disc loaded in the CDR cannot be selected.

5 Select and enter one of the tracks.

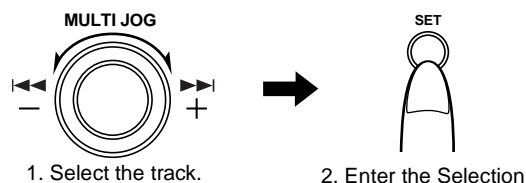

- When track 2 on the CD1 is selected for program 1:

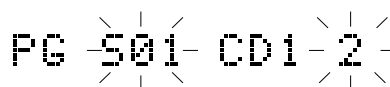

- When the selection is entered:

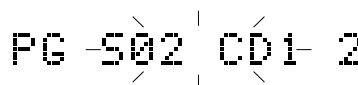

6 Repeat steps 4 and 5 to program up to 32 tracks (when you try to program more than 32 tracks, “MEMORY FULL” is displayed).

7 Press the ► button to start program play.

- The numbers of the tracks which have been played are cleared from the music calendar, and they are displayed when program play is completed.
- Operation stops automatically when all the programmed tracks have been played.

To clear a track from the program

To delete a programmed track, turn the MULTI JOG dial (or press the ◀▶ buttons on the remote) in the stop mode until the desired track is displayed in the screen. Press the CANCEL button to delete the track from the program. All the tracks following the erased one will automatically decrease by one and will be renumbered. To clear the entire program, press cancel until “PG NO PROGRAM” is displayed in the screen.

To change contents of the program

In the stop mode, press the SET button followed by the CANCEL button. Programmed steps will be erased in reverse order each time the CANCEL button is pressed twice. Continue erasing in this manner until the desired step number is reached. Follow programming steps to reprogram tracks after the desired step.

To check the contents of the program

To check what has been programmed while the tracks are being programmed, press the ■ (stop) button, and use the MULTI JOG dial (or press the ◀▶ buttons on the remote) to check.

Program playback using the remote control

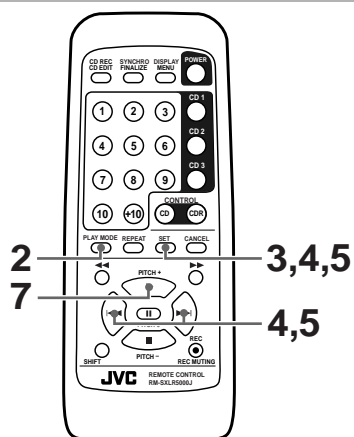

To return the program mode to the normal status in the stop mode

Repeatedly press PLAY MODE on the main unit or remote control until the play time appears in the display window.

Main Unit



Remote Control



- 1** Load the CDs whose tracks are to be programmed into the 3-CD changer.
- 2** Press the PLAY MODE button while the unit is in the CD stop mode to select PROGRAM.
 - “PG NO PROGRAM” appears in the display when no program has been made.
- 3** Press the SET button.
 - “PG S01 CD1 1” is displayed. For details on the meaning of this display, see step 3 on the previous page.
- 4** Select and enter the program source.

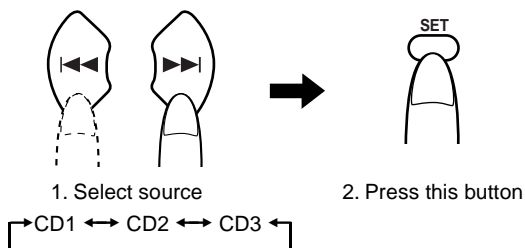

- When the SET button is pressed, the programming step and track number flash.

- 5** Select and enter the track.

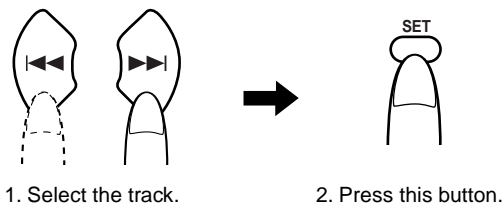

- 6** Repeat steps 4 and 5 (this procedure can be repeated for up to 32 tracks).

- 7** Press the ► button to start program play.

- Operation stops automatically when all the programmed tracks have been played.

Recording onto CD-R and CD-RW

Notes on Recording

- Do not use CD-R or CD-RW with dust and/or small scratches on the surface as this may cause the recorded sound to jump and may even cause this unit to malfunction.
- While making a recording or when the "REC" indicator lights in the display, do not subject this unit to any shock or vibration.
- Before recording on a CD-R, it is recommended to make a sample recording on a CD-RW.

Read through this section before recording.

Types of recording

The following types of recording are possible with this unit.

Manual recording (page 18)

Manually control the type of recording source and exactly what is to be recorded.

- DIGITAL (digital recording of an external source connected to this unit's OPTICAL input connector)
- CD (digital/analog recording of CDs loaded in the 3-CD changer)
- LINE (analog recording of an external source connected to this unit's LINE input connectors)
- MIC (analog recording of input from a connected microphone)

Synchronized one-button full CD recording (page 20)

Press the CD REC button while the unit is in the stop mode to instantly dub the entire selected CD in the 3-CD changer to a CD-R or CD-RW.

Synchronized one-button single track recording (page 20)

Press the CD REC button while the unit is playing or paused to instantly dub the current track on a CD in the 3-CD changer to a CD-R or CD-RW.

Listening Edit recording (page 21)

Select tracks to be recorded while listening to a CD in the 3-CD changer.

Program Edit recording (page 22)

Program tracks to be recorded from one or all of the CDs loaded in the 3-CD changer.

Synchronized start recording (page 25)

Start recording a source as soon as the CDR detects an input signal from that source.

Mixed input recording (page 26)

Combine and mix the volumes of two selected analog inputs for recording.

Automatic and manual track marking (page 19)

When automatic track marking is turned on

Tracks are automatically set in the recording. For digital sources, the track information recorded in the digital source signal is used. For analog recording, spaces of silence are interpreted as track separations.

Adding track marks manually

Manual track marking offers the flexibility to place track marks anywhere in your recording. However, when automatic track marking is turned on, manual track marking cannot be operated.

Sampling rate converter

The unit incorporates a sampling rate converter to ensure that the original digital signals will be recorded regardless of the sampling frequency (32 kHz, 44.1 kHz or 48 kHz) of the source being recorded.

Microphone connections

Use a microphone equipped with a standard plug to connect to MIC connector on this unit.

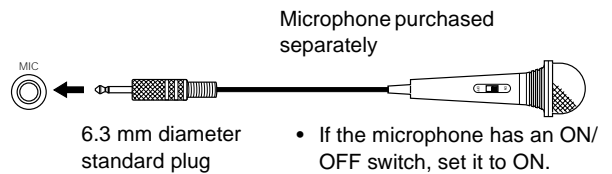

Manual Recording

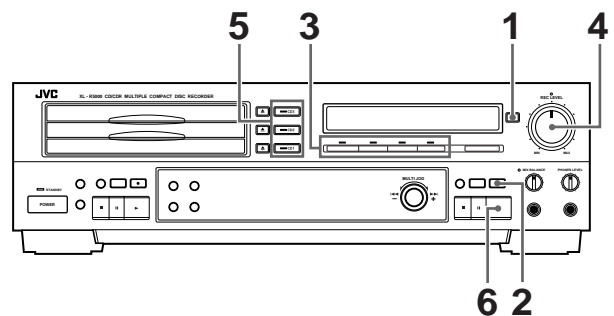

1 Insert a recordable CD-R or CD-RW.

2 Press REC ● to put the CDR in record pause mode.

- The remaining recording time on the CD-R or CD-RW appear in the display window.

3 Select (one of) the recording sources.

- DIGITAL : For recording the sound of a unit which has been connected to the OPTICAL IN connector (digital input)
When you switch from DIGITAL source recording to another source, press the DIGITAL button once to turn off the indicator, and then select the other source.
- CD : For recording the CDs loaded in into CD1, CD2 and/or CD3
Press CD repeatedly to select either DIGITAL or ANALOG recording.

Note:

Analog recording is performed for CD+LINE or CD+MIC mixing even when the CD pitch control has been set to OFF.

- LINE : For recording the sound of a unit which has been connected to the LINE IN connectors (analog input)
- MIC : For recording the sound from a microphone which has been connected to the MIC connector (analog input)

Notes

- If a source has already been selected, its corresponding lamp will light.
- When playback is stopped and the CDR is selected, pressing the DISPLAY button displays the remaining recording time on the disc for 3 seconds.

4 When analog signals are to be recorded, adjust the recording level.

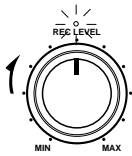

- Adjust the volume in such a way that the 0 dB display is not exceeded when the loudest sound is supplied.

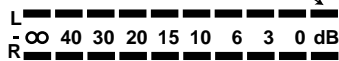

The OVER indicator should not be made to light as this may cause distortion in the recording.

5 Play the sound of the source to be recorded.

- If the CD1 button is pressed when CD serves as the source, the tracks are recorded in the following sequence:

CD1 → CD2 → CD3

6 Press the ► (play) button to start recording.

When recording is complete

Press the ■ (STOP) button to stop, the ► indicator flashes and operation stops.

Note

- When UNLOCK appears in the display, the OPTICAL IN connector is not connected to the source unit.
- Upon completion of recording, the ► indicator flashes. Operating any button while this indicator flashes may render the disc unusable. Always wait until the ► indicator stops flashing before proceeding with the next operation.
- When digital input signals are supplied, they will be recorded in their original digital form. There is no need to adjust their recording level.

To record silence in the recording

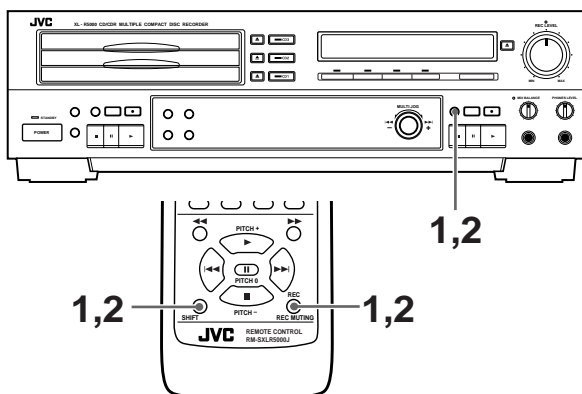

- While the CDR is recording, press the REC MUTING button on the main unit (or press REC ●/REC MUTING while the SHIFT button is pressed down on the remote control) to start recording silence.
- Release the REC MUTING button. After four seconds of silence has been recorded, the unit is put in the record pause mode.

Notes

- Four seconds of silence is recorded even if the button is held down for less than four seconds. Even if the button is held down for longer than four seconds, the unit is put in the record pause mode after the button is released.

- REC MUTING cannot be used at the beginning of a recording from the record pause mode

Setting automatic or manual track marking

When automatic track marking is turned on, tracks are automatically set in the recording. For digital sources, the track information recorded in the digital source signal is used. For analog recording, spaces of silence are interpreted as track separations. For analog recording, automatic track marking is performed when the unit detects 4 seconds of silence in the recording.

Manual track marking offers the flexibility to place track marks anywhere in your recording.

To turn on automatic track marking

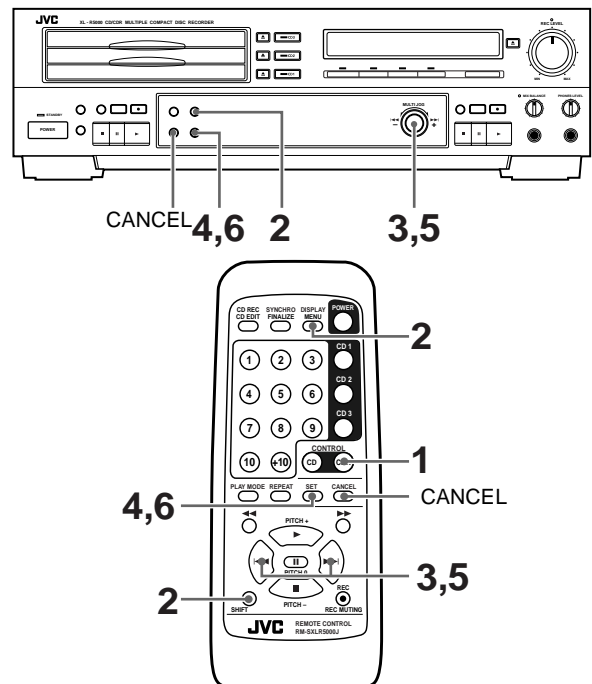

- Press CD-R on the remote control while pointing at the unit to select the CDR function.
- When the unit is in the stop mode, press the MENU button on the main unit (or the DISPLAY/MENU button on the remote control while holding down the SHIFT button).
- Turn the MULTI JOG dial or press the ◀ button on the remote control until "AUTO TRACK" appears in the display.
- Press the SET button.
 - The current setting is displayed on the screen. (The setting is on by default.)
- Turn the MULTI JOG dial or press the ◀ button on the remote control to select "AUTO TR ON".
- Press the SET button.
 - If "AUTO TR ON" is selected, the AUTO TRACK indicator lights in the display.
 - Press the CANCEL button to cancel the procedure and return to the normal display.

To add track marks manually

- 1 In the procedure above, set the automatic track setting to "AUTO TR OFF".
- 2 During recording, press the SET button to apply a track mark.

Notes

- Even if automatic track marking is turned off, automatic track marking will be performed during synchronized one-button recording. When this occurs, manual track marking is temporarily disabled.
- Tracks must be at least four seconds in length. Pressing the SET button less than four seconds after the previous track mark creates a new track mark once 4 seconds of recording has been performed.

Synchronized Recording of 3-CD Changer Playback

Performing synchronized one-button recording of a full CD

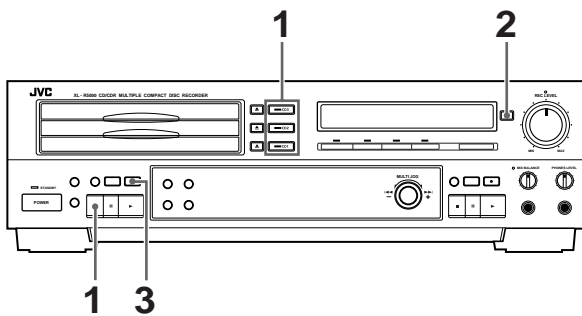

One button synchronized recording of CDs loaded in the 3-CD changer.

1 Select and stop the CD to be recorded.

Example: When recording CD1

- Only the selected CD is recorded.

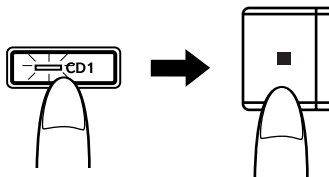

2 Load a recordable CD-R or CD-RW and close the tray.

3 Press the CD REC button to start recording.

- After "DISC DUBBING" is displayed, CD play and CDR/CD-RW recording start simultaneously. This is called synchro recording. Recording starts from the first track of the CD.

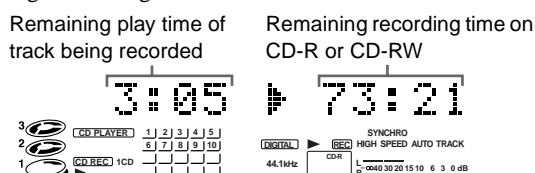

- When a CD is recorded, its digital signals are recorded in their original form. A track mark is automatically placed where one track changes to the next, and the track number also changes.

When recording is complete

After "STOP DUBBING" is displayed, operation stops automatically. It also stops automatically when CD play finishes.

To check a track number during recording

Press DISPLAY button on the main unit (or DISPLAY/MENU on the remote control).

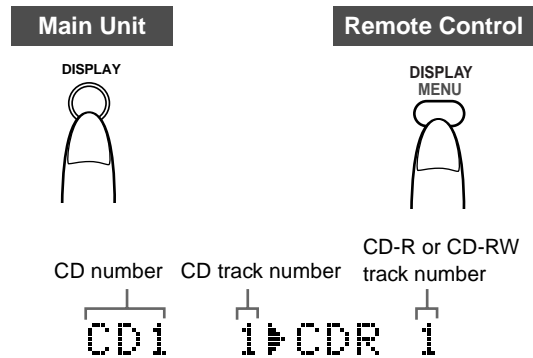

To stop the recording at any time

Press the ■ (stop) button and "STOP DUBBING" flashes.

Notes

- There is no need to adjust the recording level (for a digital recording).
- If the source CD being recorded from the 3-CD changer is itself a digital copy, digital recording cannot be performed (see page 39 for more details.). When this occurs, the recording type will switch automatically from digital to analog.
- This type of recording is not possible while a CD is playing.
- When the CD REC button is pressed, the function is automatically switched to CD. This means that when the CD to be recorded has been selected, recording can proceed straightaway.
- Upon completion of recording, "STOP DUBBING" flashes. Always wait for "STOP DUBBING" to be cleared before proceeding with the next operation.

Performing synchronized one-button recording of a single track

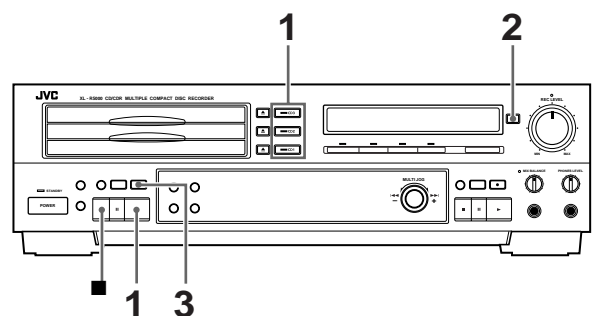

1 Select a disc and start playback.

Example: When planning to record a track on CD1

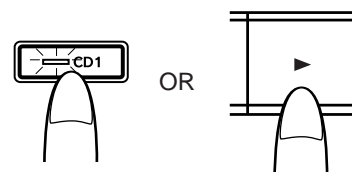

2 Insert a recordable CD-R or CD-RW in the CDR disc tray.

3 While the disc is playing back the track you want to record or if that track is being paused, press **CD REC** on the main unit or **CD REC/CD EDIT** on the remote control.

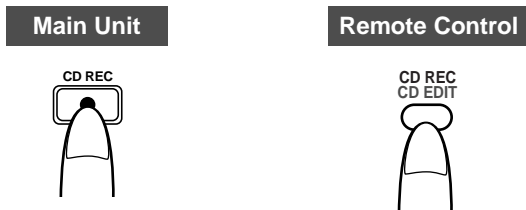

- The CD restarts playback from the beginning of the track and the CDR starts recording. Recording stops when the track is finished.
- When a CD is recorded, its digital signals are recorded in their original form. A new track mark is automatically placed at the beginning of the track being recorded.

When recording is complete

After “STOP DUBBING” is displayed, operation stops automatically.

To stop recording at any time

Press the ■ (stop) button.

The recording mode is released after “STOP DUBBING” is displayed.

Notes

- There is no need to adjust the recording level (for a digital recording).
- If the source CD being recorded from the 3-CD changer is itself a digital copy, digital recording cannot be performed. When this occurs, the recording type will switch automatically from digital to analog.
- Upon completion of recording, “STOP DUBBING” is displayed. Always wait for “STOP DUBBING” to be cleared before proceeding with the next operation.

Listening Edit Recording

Selected tracks can be programmed and recorded.

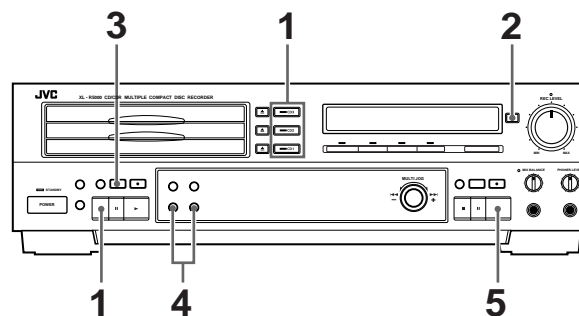

- 1** Select and stop the CD to be recorded.
- 2** Load a recordable CD-R or CD-RW in the CDR tray.
- 3** Press the **CD EDIT** button on the main unit (or press the **CD REC/CD EDIT** button while holding down the **SHIFT** button on the remote control) to select the Listening Edit mode.

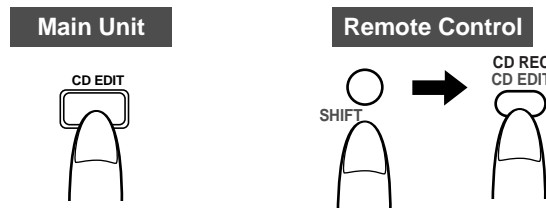

- The unit is put in the record pause mode, and the selected disc starts playback.
- Starts play from the first track, “LISTEN EDIT” appears in the display, and the play time of the first track and remaining recording time on the CD-R or CD-RW are displayed. CDR is set to the record pause mode.

4 Program the tracks while the CD is playing by assigning a tag to each track on the disc.

a. When the track now playing is to be recorded

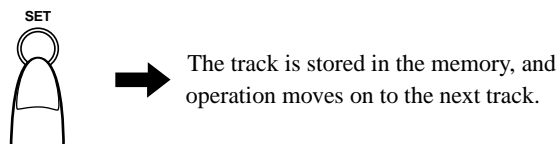

b. When the track is not to be recorded

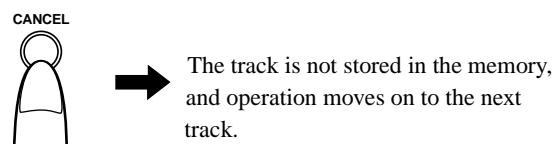

When the first track has been stored in memory

Play time of second track Remaining recording time on a CD-R or CD-RW (pre-calculated)

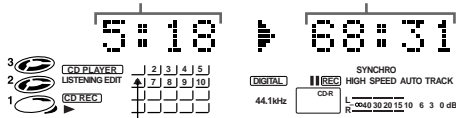

"1" is cleared from the music calendar.

Note

- When there is not much recording time left on the CD-R or CD-RW, tracks that are longer than the remaining time (pre-calculated) can be programmed but "NO REM" appears in the display.

When the last programmed selection is in the memory

Press the CD EDIT button to display "LAST L-PG OK?". If you want to record the programmed tracks in the memory, press the ► or SET button. If you want to program a new selection of tracks, press the CANCEL button.

5 Press the CDR CONTROL ► button to start recording.

- If "SHORT REM OK?" appears in the display, it may not be possible to record the programmed selection. During actual recording, this unit checks the actual remaining recording time before the beginning of each programmed selection. If that selection cannot be recorded in its entirety, it will not be recorded. Press CDR CONTROL ► to start recording. Press "CANCEL" to restart the programming procedure.
- Only the tracks on the CD that were selected are recorded.

When recording is complete

After "STOP DUBBING" is displayed, operation stops automatically. It also stops automatically when play of the last CD finishes.

To stop the recording at any time

Press the ■ (stop) button. The recording mode is released after "STOP DUBBING" is displayed.

Notes

- There is no need to adjust the recording level (for a digital recording).
- Up to 32 tracks can be included in the programming. The same track cannot be programmed twice.
- Upon completion of recording, "STOP DUBBING" is displayed. Always wait for "STOP DUBBING" to be cleared before proceeding with the next operation.
- The last program information (the most recently created program still stored in the unit's memory) will be erased if the trays of the 3-CD changer are opened and if Program Edit recording is performed.

Program Edit Recording

This type of recording allows you to make a program of your favorite tracks on any of the CDs loaded in the 3-CD changer in any order you like. Similar to program playback, you can even choose to use program playback information for this type of recording.

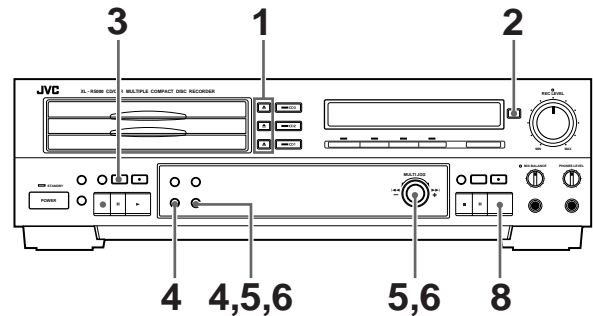

- Load CDs in the 3-CD changer.
- Load a recordable CD-R or CD-RW in the CDR tray.
- Press the CD EDIT button twice on the main unit (or the press the CD REC/CD EDIT button while holding down the SHIFT button on the remote control) to select the Program Edit mode.

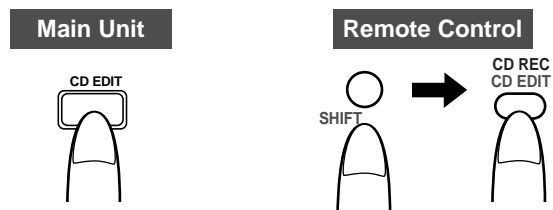

- The unit is put in the record pause mode and "PROGRAM EDIT" appears in the display.
 - At this time, if it is necessary, the unit is reading the track and time information (called the TOC, or Table of Contents) on each of the loaded discs and "TOC READING" displays.
- If you have already programmed the tracks on the discs using program Edit, "LAST P-PG OK?" appears in the display. Press the ► or SET button to use the stored program information and proceed to step 8. To create a new program for recording, press the CANCEL button.
- If you press the CANCEL button, the remaining time followed by the program step information appears in the display.

5 Select and enter the program source.

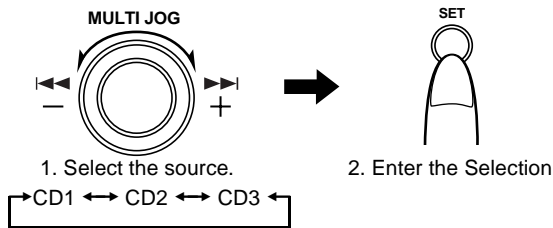

- The source can be selected in either direction using the MULTI JOG dial on the main unit or the ◀◀ and ▶▶ buttons on the remote control.
- When the SET button is pressed, the programming and track number flash.

6 Select and enter one of the tracks.

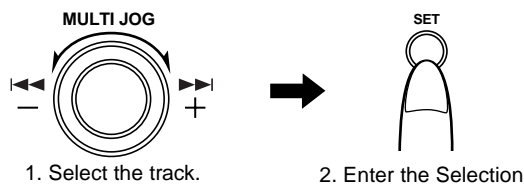

- After the track is entered, the amount of time remaining on the CD-R or CD-RW appears in the display followed by the information for the next step in the program.

7 Repeat steps 5 and 6 to continue programming tracks.

- Up to 32 tracks can be programmed. The same track may be programmed more than once.
- The Program Edit mode is stopped if 32 steps have been programmed or if there is no more time remaining on the CD-R or CD-RW.

8 Press the CDR CONTROL ► button to start recording the program.

- Recording starts from the first step in the program, and stops when the last step is finished.
- The program information is maintained in memory until one of the disc trays (CD1, CD2, CD3) is opened.

When recording is complete

After "STOP DUBBING" is displayed, operation stops automatically. It also stops automatically after the last step in the program is finished.

To stop recording at any time

Press the ■ (stop) button.

The recording mode is released after "STOP DUBBING" is displayed.

Note

- If the source CD being recorded from the 3-CD changer is itself a digital copy, digital recording cannot be performed. When this occurs, the recording type will switch automatically from digital to analog.
- The last program information (the most recently created program still stored in the unit's memory) will be erased if the trays of the 3-CD changer are opened and if listening Edit recording is performed.

3-CD Changer to CDR Recording Options

There are a number of advantages of having a 3-CD changer and CDR in the same unit, mainly that the unit has direct control over both components. Because of this, the following recording options are available: high-speed (2x) recording and track spacing.

Setting the unit to perform high-speed recording

High-speed (2x) recording is only possible for digital recording from the 3-CD changer to the CDR.

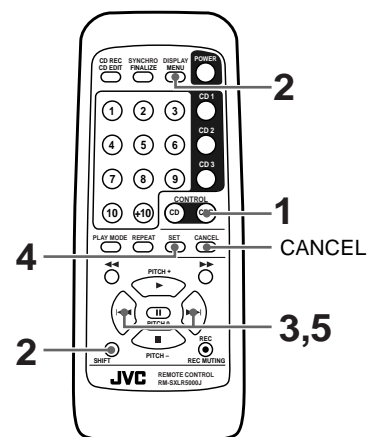
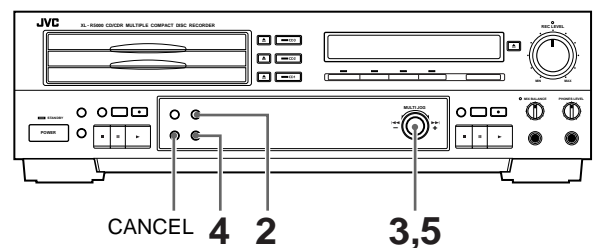

- 1 Press the CDR button on the remote control while pointing at the unit to select the CDR function.
- 2 When the unit is in the stop mode, press the MENU button on the main unit (or the DISPLAY/MENU button on the remote control while holding down the SHIFT button)
- 3 Turn the MULTI JOG dial or press the ◀◀/▶▶ button on the remote control until "DUB-SPEED" appears in the display.
- 4 Press the SET button.

- The current setting is displayed on the screen. (The setting is 2X by default.)

5 Turn the **MULTI JOG** dial or press the **◀◀/▶▶** button on the remote control to select “**DUB-SPEED 2X**” or “**DUB-SPEED 1X**”.

- If “**DUB-SPEED 2X**” is selected, the **HIGH SPEED** indicator lights in the display.
- Press the **CANCEL** button to cancel the procedure and return to the normal display.

Notes

- High-speed (2x) recording is not possible under the following conditions:
 - When analog recording is performed
 - When pitch adjustments have been made to the playback CD
 - When mixed input recording is being performed
- When high-speed (2x) recording is performed, there is no audio output from any of the output connectors (**LINE OUT**, **OPTICAL OUT**, **HEADPHONE**), and therefore it is not possible to monitor the recording. However, the current recording level is displayed in the level meter.

Setting the auto track spacing function

When this function is turned on, the unit records 2 seconds of silence at the beginning of each track during any automatic recording from the 3-CD changer to the CDR.

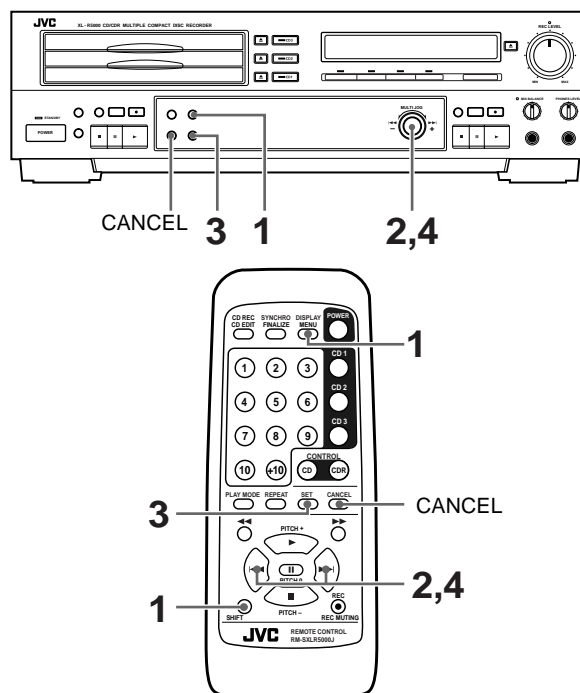

- 1** When the unit is in the stop mode, press the **MENU** button on the main unit (or the **DISPLAY/MENU** button on the remote control while holding down the **SHIFT** button).
- 2** Turn the **MULTI JOG** dial or press the **◀◀/▶▶** button on the remote control until “**TRACK SPACE**” appears in the display.
- 3** Press the **SET** button.
 - The current setting is displayed on the screen. (The setting is on by default.)
- 4** Turn the **MULTI JOG** dial or press the **◀◀/▶▶** button on the remote control until “**TR SPACE ON**” or “**TR SPACE OFF**”.
 - There is no indicator to show that lights to the status of this function. During synchronized one-button recording, Listening Edit recording, and Program Edit recording modes, a 2 second silence will be recorded before every track .
 - Press the **CANCEL** button to cancel the procedure and return to the normal display.

Note

This function works for all types of recording where recording is started from the record pause mode with the exception of synchronized recording.

Synchronized Start Recording of External Components

Perform synchronized start recording of sources such as DAT and CD connected to either the DIGITAL IN OPTICAL connector or LINE IN (REC) connectors on this unit. Recording is automatically started when the unit detects audio signal input.

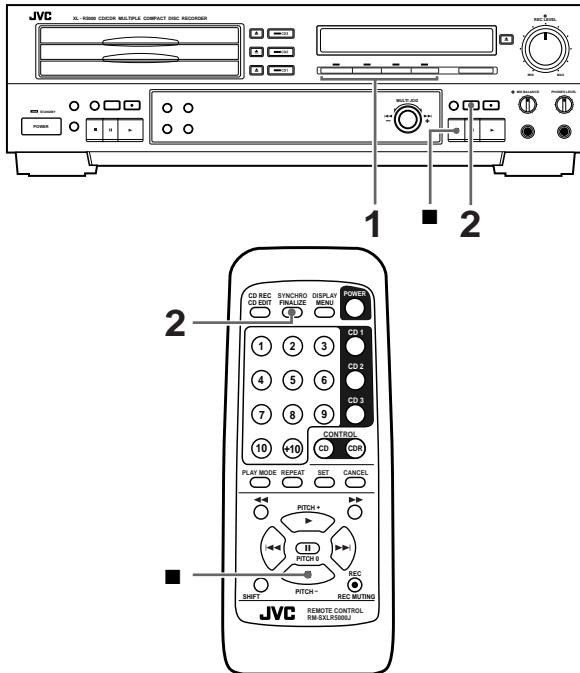

1 Press the **REC SOURCE SELECTION** button repeatedly to select an input source.

2 Press the **SYNCHRO** button (or the **SYNCHRO/FINALIZE** button on the remote control).

- The unit is put in the record pause mode, the **SYNCHRO** indicator lights in the display.
- For this procedure to work, playback of the source component should be stopped.

3 Start playing the source component

When performing synchronized recording of a digital source

- Recording is started based on the digital signal.
- Track marking is based on track information recorded in the digital signal. (CD, MD, DAT only.) For other digital sources, track marking is based on spaces of silence.

When performing synchronized recording of an analog source

- Recording is started when the unit detects an audio signal.
- Track marking is based on spaces of silence which the unit interprets to be track breaks. If automatic track marking has been turned off, manual track marking is necessary.

When recording is started, the “**SYNCHRO**” indicator disappears from the display.

To stop recording at any time

Press the ■ (stop) button.

When recording external sources

- Synchronized recording (other than synchronized start recording) cannot be used to record an external source (connected to **DIGITAL IN OPTICAL** or **LINE IN (REC)**). During synchronized recording, this unit is put in record pause after the end of each recorded track, and adjusts the blank between tracks to be uniform. Because this unit is not capable of predicting or adjusting the blank between the source tracks in the input signal, the blank between tracks that are recorded will be identical to those of the source.
- Normally, manual recording is recommended for recording an external source (connected to **DIGITAL IN OPTICAL** or **LINE IN (REC)**). Even if synchronized start recording is used, recording will continue until there is no remaining time left on the CD being recorded*. For this reason, when recording an external source, be sure to press **CDR CONTROL ■** to stop recording or **CDR CONTROL II** to put this unit in record pause mode when the source you are recording is finished.

* When an MD player is connected to **DIGITAL IN OPTICAL**, this unit is put in record pause when MD playback is stopped or paused.

Notes

- Please note that if “**AUTO TRACK**” is set to “**AUTO TR ON**”, track numbers are automatically assigned even with external sources.
- When the external source is a CD, MD or DAT player connected to the **DIGITAL IN OPTICAL** connector on this unit, this unit can automatically start and stop recording if a single track is recorded. For more information, see “Setting Up Synchronized Recording for External Digital Sources” on page 31.

CAUTION

When performing synchronized start recording of an external component, there is a chance that a section at the beginning of the source signal will not be recorded. When this occurs, please perform manual recording.

Mixed Input Recording

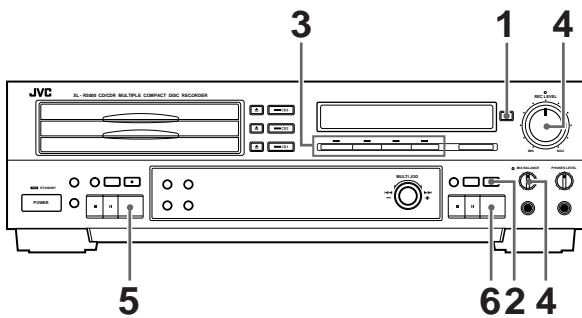

- 1** Load a recordable CD-R or CD-RW in the CDR disc tray.
- 2** Press the REC ● button on the main unit to put the CDR in the record pause mode.
 - The remaining recording time on the disc appears in the display.
- 3** Select two recording sources to be mixed and recorded.

Example:

CD and LINE are selected

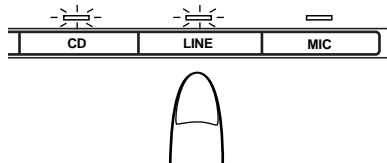

- Press the same button again to clear the selection.
- Select the CD and LINE buttons to mix and record a CD loaded in the 3-CD changer with the line input signals from an external source.
- Select the CD and MIC buttons to mix and record a CD loaded in the 3-CD changer with the input of a microphone connected to the MIC connector.
- Select the LINE and MIC buttons to mix and record the line input signals from an external source with the input of a microphone connected to the MIC connector.
- The lamps of the selected sources light.
- Since analog signals are recorded, both the REC LEVEL and MIX BALANCE lamps light.

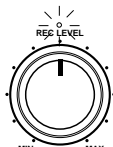
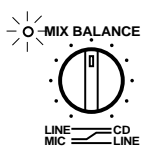

- 4** Play the two sources together and adjust the recording level and mixing balance.

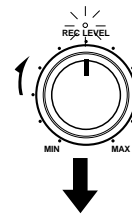

| | MIX BALANCE | MIX BALANCE |
|------------|-------------------------------|-------------------------------|
| CD + LINE | CD volume is reduced. | Line input volume is reduced. |
| CD + MIC | CD volume is reduced. | Mic input volume is reduced. |
| LINE + MIC | Line input volume is reduced. | Mic input volume is reduced. |

- Adjust the volume in such a way that the 0 dB display of the level meter is not exceeded when the loudest sound is supplied.
- If the CD input is selected for mixed recording, the pitch controls may be used to adjust the speed of CD playback for mixing and recording purposes. (See page 15.)
- If the microphone level is set too high, you may experience a loud howling sound from your speakers. If this occurs, turn down the volume of the microphone by turning down the volume of the amp/receiver powering the speakers you are using to monitor the sound.
- When you have finished adjusting the recording level and the mix balance, set the sources back to the point where you want to start recording at.

- 5** Start playback of the sources to be recorded.

- If the CD1 button is pressed when mixing with a CD and recording the result, the tracks are recorded in the following sequence: **CD1 → CD2 → CD3**

- 6** Press the CDR CONTROL ► button to start the recording.

When recording is complete

Press the CDR CONTROL ■ (stop) button. The ► indicator flashes and operation stops.

Special Recording Edit Operations

Skipping a Recorded Track on a CD-R or CD-RW (Track Skip)

Occasionally, there may be tracks on a disc that are partial, repeated, or are otherwise unwanted. Before a CD-R or CD-RW is finalized, it is possible to put a skip marker for that track, which is then recorded in the TOC information at most 21 tracks per disk. When the disc is later finalized and played back, it will play back as if the track had never been recorded.

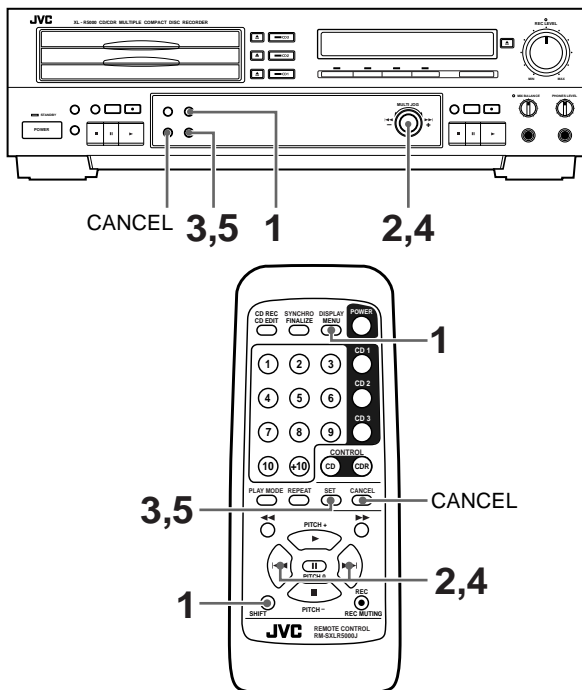

- 1** When the unit is in the stop mode, press the **MENU** button on the main unit (or the **DISPLAY/MENU** button on the remote control while holding down the **SHIFT** button).
- 2** Turn the **MULTI JOG** dial or press the **◀◀/▶▶** button on the remote control until “**TRACK SKIP**” appears in the display.
- 3** Press the **SET** button.
 - “SKIP (track number)?” appears in the display.
 - Press the **CANCEL** button if you do not wish to perform this procedure.
- 4** Turn the **MULTI JOG** dial or press the **◀◀/▶▶** button on the remote control to select the track number to be skipped.
- 5** Press the **SET** button.
 - A skip marker is applied to the selected track, the PMA is updated and “**WRITE SKIP**” is displayed. When complete, the normal display is returned to.
 - The track to be skipped is cleared from the music calendar.

Notes

- Even if a track is skipped, the recorded information is not erased and remaining time do not change.
- **It is important to note, that while a skip marker can be applied to a track, this procedure cannot be reversed.**
- Tracks that have been assigned **TRACK SKIP** markers are only skipped during playback on this unit and other compatible CD players with **TRACK SKIP** function.

Erasing a track or tracks (ERASE function)

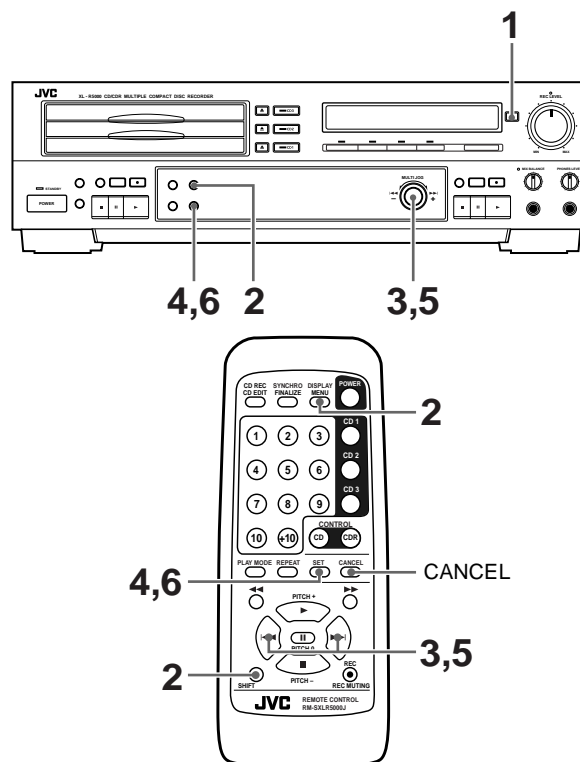

- 1** Load the unfinalized CD-RW to be edited, and set the function to CDR.
 - The number of tracks and play time are displayed.
- 2** When the unit is in the stop mode, press the **MENU** button on the main unit (or the **DISPLAY/MENU** button on the remote control while holding down the **SHIFT** button).
- 3** Turn the **MULTI JOG** dial or press the **◀◀/▶▶** button on the remote control until “**TRACK ERASE**” appears in the display.

4 Press the SET button.

- “ERASE (start track) – (last track)” appears in the display. (Initially, the start track and the last track are both the last track number recorded on the CD-RW.)
- Press the CANCEL button if you do not wish to perform this procedure.

5 If needed, use the MULTI JOG dial on the main unit or press the ◀◀ and ▶▶ buttons on the remote control to set the number of tracks preceding the last track that you want to erase.

- Please note that all tracks following the start track will be erased. For example, when track 8 on an 11 track CD-RW is assigned as the start track, tracks 8, 9, 10, and 11 will be erased.

6 Press the SET button.

- After “ERASE TRACK” is displayed, the selected tracks are erased, and the normal display is returned to.
- The track to be erased is cleared from the music calendar.
- Tracks can only be erased from the end of the recording.

Notes

- Once a track is erased, the recording cannot be restored.
- Do not disconnect the power cord or subject the unit to the vibration during an erase operation. Doing so may make it impossible to play the CD-RW.

Erasing all the tracks (DISC ERASE function)

The DISC ERASE function clears all of the data recorded on a CD-RW.

Caution

If the disc is damaged or there is disc related trouble, this function may not be possible.

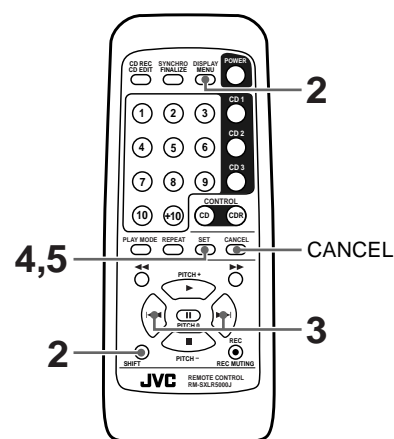
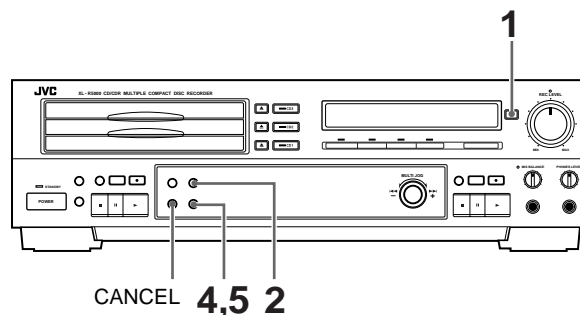

1 Load the unfinalized CD-RW to be edited, and set the function to CDR.

- The number of tracks and play time are displayed.

2 When the unit is in the stop mode, press the MENU button on the main unit (or the DISPLAY/MENU button on the remote control while holding down the SHIFT button).

3 Turn the MULTI JOG dial or press the ◀◀/▶▶ button on the remote control until “DISC ERASE” appears in the display.

4 Press the SET button.

- “ERASE DISC?” appears in the display.
- Press the CANCEL button if you do not wish to perform this procedure.

5 Press the SET button.

- This procedure takes about one and a half minutes to perform. During the procedure, the length of the level meter is used to indicate approximately how much time is remaining until disc erasure is complete. When complete, the normal display is returned to.

Finalization

Finalization marks the final process in recording on a CD-R or CD-RW in which the TOC (Table Of Contents) is written to the disc. When this procedure is completed, it will be possible to play CD-R/CD-RW on CD players compatible with CD-R/CD-RW.

- **Please note that once a CD-R has been finalized, no more recording is possible on the disc.**
- If the power of the unit is turned off or the power plug is pulled from the wall outlet during the finalization process, the recording may be lost and the disc may not be usable.
- Even after a CD-RW has been finalized, further recording and editing is still possible if the TOC information on the disc is erased using the UNFINALIZE function. (See page 30.)
- When an unfinalized CD-R or CD-RW is loaded in the CDR and the EJECT 0 button is pressed to open the CDR disc tray, "FINALIZE?" appears in the display window. When this is the case, skip step 1 on this page.

2 Press FINALIZE on the main unit (or press SYNCHRO/FINALIZE on the remote control while holding down SHIFT) again to start the finalization.

- The length of time that this process requires is about 2 minutes. During the procedure, the length of the level meter is used to indicate approximately how much time is remaining until finalization is complete.
- The 3-CD changer of this unit is compatible with finalized CD-RW, however, not all CD players can play back CD-RW even after they have been finalized.
- During the finalization process, it will not be possible to remove or load discs in the 3-CD changer, nor is playback of CDs loaded in the 3-CD changer possible.

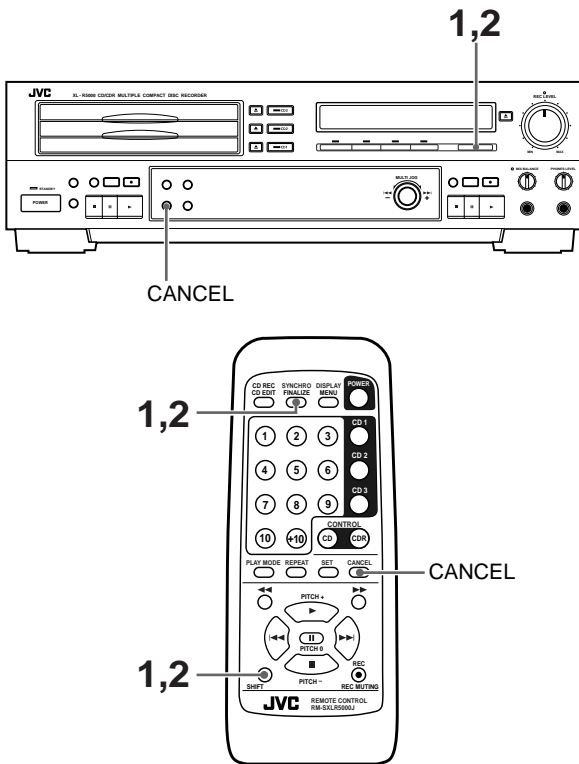

1 Press FINALIZE button on the front panel (or press the SYNCHRO/FINALIZE button on the remote control while holding down SHIFT).

- "FINALIZE?" appears in the display window.
- If you want to cancel the finalization process at this point, press the CANCEL button on the main unit or remote control.

Making recording possible again on a finalized CD-RW (UNFINALIZE function)

Once a CD-R has been finalized, further recording on that disc cannot be performed. However, by erasing the TOC (Table of Contents) on a CD-RW, the disc can be recorded on again.

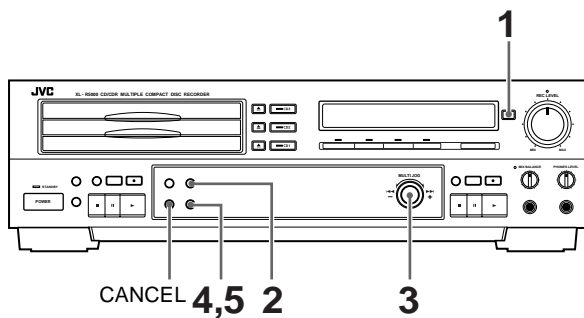

1 Load a CD-RW into the CDR deck.

- The CD-RW and FINALIZED indicators light for a CD-RW that has been finalized.

2 When the unit is in the stop mode, press the MENU button on the main unit (or the DISPLAY/MENU button on the remote control while holding down the SHIFT button)

3 Turn the MULTI JOG dial or press the <<|>> button on the remote control until “UNFINALIZE” appears in the display.

4 Press the SET button.

- “UNFINALIZE?” appears in the display.
- Press the CANCEL button to cancel the procedure and return to the normal display.

5 Press the SET button again to confirm the operation.

- “UNFINALIZE” appears in the display and the unfinalization procedure is performed. The procedure takes about one and a quarter minutes to perform. During the procedure the length of the level meter is used to indicate approximately how much time is remaining until unfinalization is complete. Upon completion, the normal display is returned to.

Bypassing the FS Converter (Sampling Frequency Converter*) for More Efficient Digital Recording

* known as Sampling Rate Converter.

The FS converter of this unit allows it to convert the digital signals of sources with sampling frequencies other than 44.1 kHz to the sampling frequency of 44.1 kHz necessary for it to be recorded to a CD-R or CD-RW.

When the FS converter is set to “OFF”, the FS converter is bypassed when the digital signal of the source has a sampling frequency of 44.1 kHz (even if the FS converter is set to “OFF”, the FS converter cannot be bypassed for digital signals with sampling frequencies other than 44.1 kHz) and it automatically turns ON if high-speed recording (DUB-SPEED 2X) from 3CD is started. To record by bypassing the FS converter, use “DUB-SPEED 1X” recording. With this setting, the pure digital signal is preserved. When recording specially encoded discs such as dts*¹ CD, HDCD CD*², etc., be sure to use the following set this CONVERTER to “OFF” (see step 4) and DUB-SPEED to “1X” (see step 5 on page 23).

When the FS converter is set to “ON”, the FS converter functions even when the sampling frequency of the digital signal is 44.1 kHz. The obvious merit of this setting is that it reduces jitter in disc recording. For this reason, setting this function to “ON” is recommended for most recording purposes.

*¹dts is trademark of Digital Theater Systems, Inc.

*²HDCD[®] is registered trademark of Pacific Microsonic, Inc.

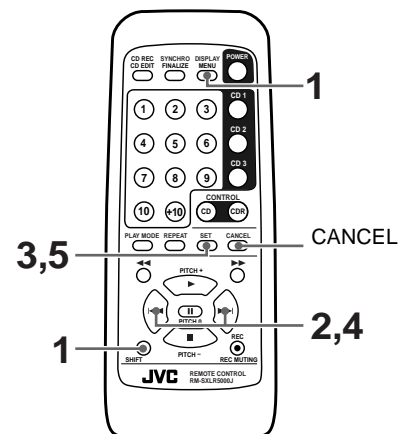
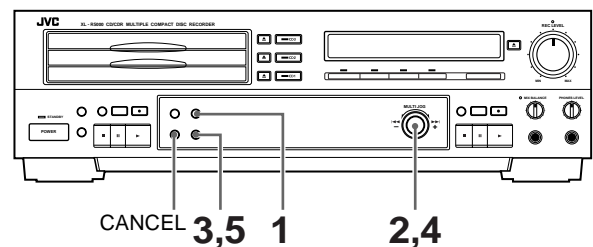

1 When the unit is in stop mode, press the MENU button (or the DISPLAY/MENU button on the remote control while holding down the SHIFT button).

2 Turn the MULTI JOG on the main unit or press the ◀◀ and ▶▶ buttons on the remote control until “CONVERTER” appears in the display.

3 Press the SET button.

- The current setting appears in the display. (The setting is ON by default.)
- Press the CANCEL button if you do not wish to perform this procedure.

4 Turn the MULTI JOG on the main unit or press the ◀◀ and ▶▶ buttons on the remote control to select “ON” or “OFF”.

- When the FS converter setting is set to “ON”, the FS converter is used for all recording regardless of the frequency of the source.
- When the FS converter is set to “OFF”, the FS converter is bypassed during input of digital sampling frequencies of 44.1 kHz and during analog and multiple input recording. However, when source sampling frequencies of 32 kHz or 48 kHz are encountered, the FS converter is used regardless of the setting.
- Press the CANCEL button if you do not want to perform this procedure. The setting is not changed.

5 Press the SET button.

1 When the unit is in stop mode, press the MENU button (or the DISPLAY/MENU button on the remote control while holding down the SHIFT button).

2 Turn the MULTI JOG on the main unit or press the ◀◀ and ▶▶ buttons on the remote control until “D-IN SYNCHRO” appears in the display.

3 Press the SET button.

- The current setting appears in the display.

4 Turn the MULTI JOG on the main unit or press the ◀◀ and ▶▶ buttons on the remote control to select “START” or “START&STOP”.

- When “START” is selected, only the start of the digital signal is recorded synchronously.
- When “START&STOP” is selected, both the start and stop of single track recording are controlled by information in the source digital signal.
- Press the CANCEL button if you do not want to perform this procedure. The setting is not changed.

5 Press the SET button.

- Please note that the type of synchronized recording being performed as set in the above procedure is not indicated in the display during actual recording. Even when recording is started, only the “SYNCHRO” indicator remains lit until recording is stopped.
- Even if this setting is set to “START&STOP”, recording is concluded automatically if the source is stopped, the disc is changed, or if a track search is performed.

Setting Up Synchronized Start Recording for External Digital Sources (CD, MD, and DAT only)

When performing digital synchronized start recording of an externally connected digital source, synchronized start recording begins when a digital signal is encountered in the record pause mode. However, it is also possible to set this unit to start and stop recording when you are recording a single track.

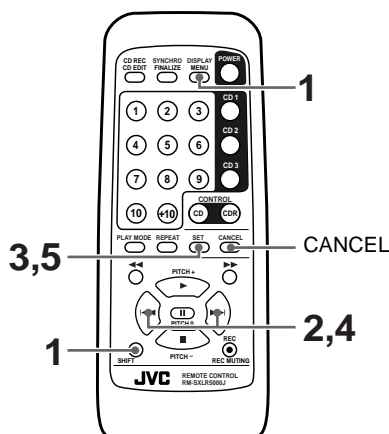
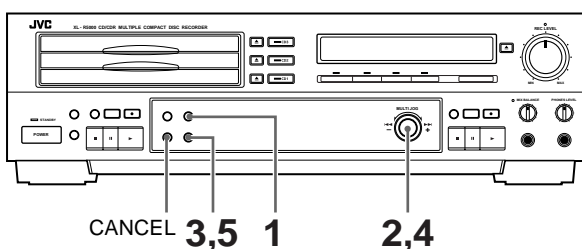

Resetting the Unit to the Factory Default Settings

By performing the following procedure, all menu settings stored in the unit are cleared and the unit is reset to the factory default settings.

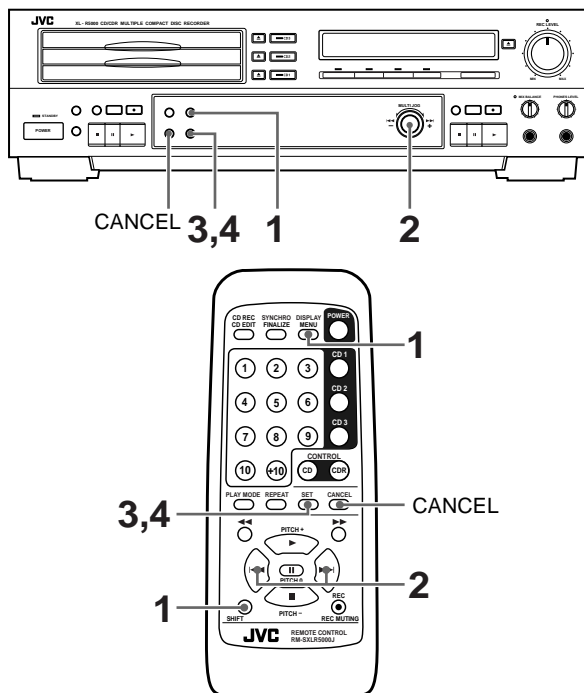

- 1** When the unit is in stop mode, press the **MENU** button (or the **DISPLAY/MENU** button on the remote control while holding down the **SHIFT** button).
- 2** Turn the **MULTI JOG** on the main unit or press the **◀◀** and **▶▶** buttons on the remote control until “**SET DEFAULT**” appears in the display.
- 3** Press the **SET** button.
 - “**SET DEFAULT?**” appears in the display.
 - Press the **CANCEL** button if you do not want to perform this procedure.
- 4** Press the **SET** button.
 - The unit is reset to the factory default settings and the unit is put in the stop mode.

Setting the Clock

Setting the Present Time

(To be performed when the unit is to be used for the first time)

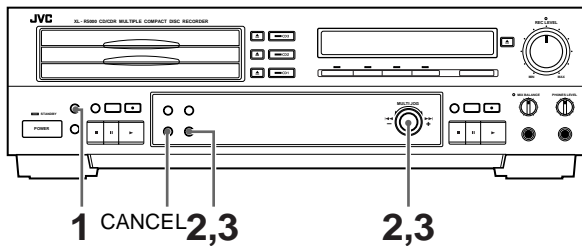

Example: Setting the time to 1:15 PM (while the power is switched to STANDBY).

This unit uses a 12-hour clock to indicate the time.

1 Press the CLOCK/TIMER button.

- The time display is illuminated, and the "hour" indicators start flashing.

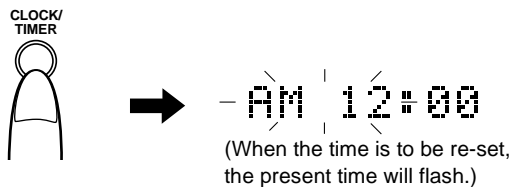

2 Turn the MULTI JOG dial to change the hour display to "PM 1", and then press the SET button.

- The hour display stops flashing, and the minute display starts to flash.

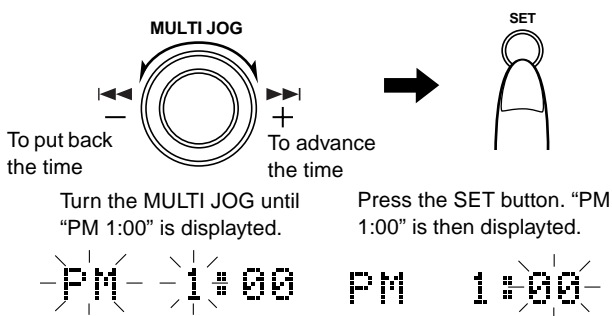

3 Turn the MULTI JOG dial to change the minute display to "15", and then press the SET button.

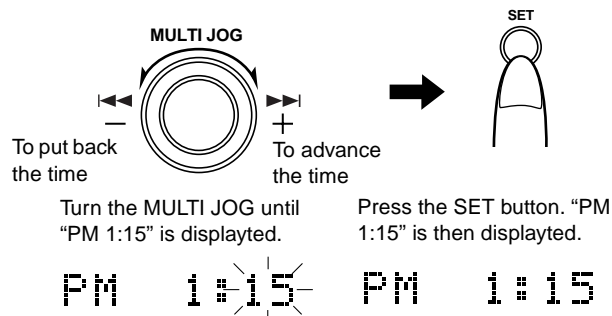

- The current time "1:15" is displayed and the display window darkens.

- If you made a mistake in entering the current time, repeat this procedure from the beginning.
- If the CANCEL button is pressed while setting the "minute" display, the flashing "hour" display is restored. This function comes in handy for correcting the "hour" display.

To ascertain the correct time

In most areas, there is a telephone number you can call for the correct time, consult your telephone directory for assistance.

To change or adjust the time display

It is possible to change the time even after it has been set. Press the CLOCK/TIMER button repeatedly to select the time display, and set the time as described in the procedure on this page. The time can be adjusted even when the unit is in standby.

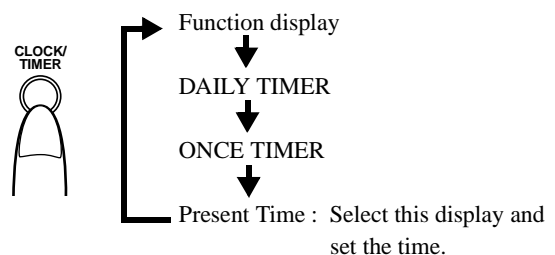

Regarding the time display

- The time display for Canada and USA models uses a 12-hour clock.
- Models for other countries use a 24-hour clock.

The illustrations in this Instruction Manual show the Canada and USA model. For users of other models, please note that "AM" and "PM" indications will not be displayed as shown in this manual. Please refer to the illustrations below for differences in the two time display types.

| | |
|--------------------|---------------------|
| For Canada and USA | For other countries |
| PM 1:00 | 13:00 |

- The time display cannot be switched between the 12-hour and 24-hour clock display.

Timer Operations

Timer Play (wake-up play)

Before proceeding with timer programming, make sure that the present time has been set correctly. (See page 33.)

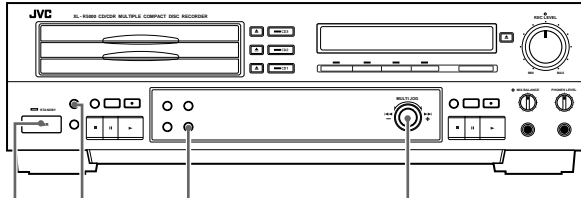

1,11 2 3~8,10 4~7,9

Example: Setting the unit to turn on and play a CD from 7:15 AM to 8:15 AM.

1 Turn on the power.

- The selected function ("CD" at the time of purchase) is displayed.

2 Press CLOCK/TIMER repeatedly to select the timer mode (DAILY TIMER or ONCE TIMER).

- The mode changes each time this button is pressed.

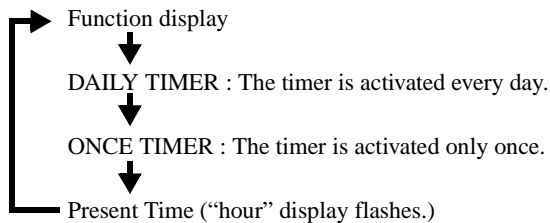

3 Press the SET button.

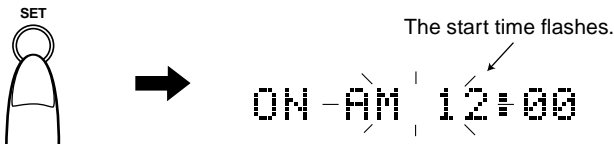

4 Turn the MULTI JOG dial to set the hour display to "AM 7", and press SET.

- The hour display stops flashing and the minute display starts to flash.

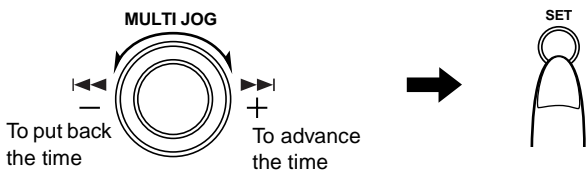

- Turn the MULTI JOG until "AM 7:00" is displayed.
- Press the SET button. "AM 7:00" is then displayed.



5 Turn the MULTI JOG dial to change the minute display to "15", and then press the SET button.

- The hour display of the timer stop time starts to flash.

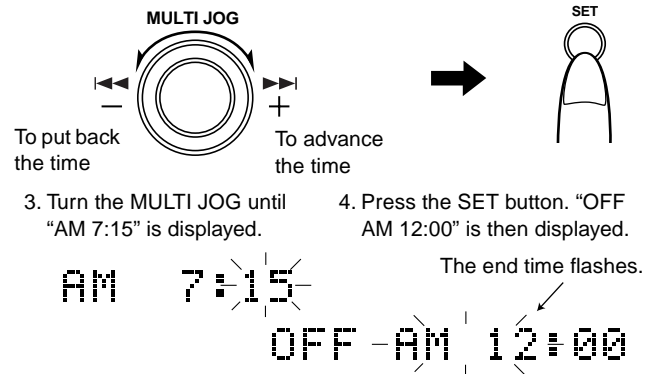

6 Turn the MULTI JOG dial to set the hour display to "8", and press SET.

- The hour display stops flashing and the minute display starts to flash.

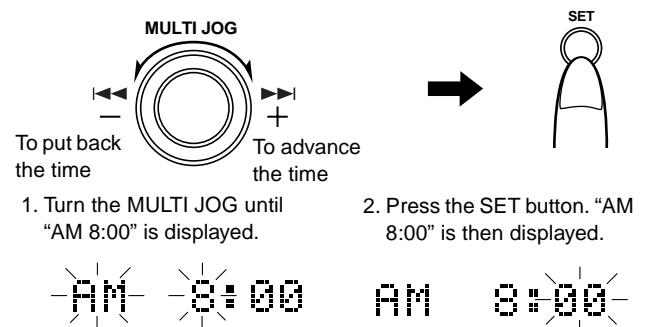

7 Turn the MULTI JOG dial to change the minute display to "15", and then press the SET button.

- "PLAY" is displayed.

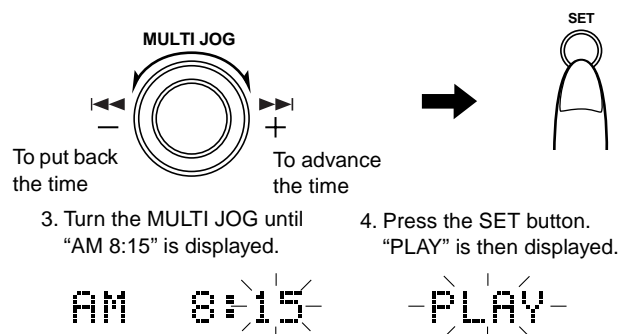

When "Play" is displayed, it is necessary to set the Timer Play or Timer Recording function.

For Timer Play and Timer Recording, see the procedure on the following page.

Note

- If the CANCEL button is pressed while setting the "minute" display, the flashing "hour" display is restored. This function comes in handy for correcting the "hour" display.

8 While “PLAY” is flashing, press the SET button

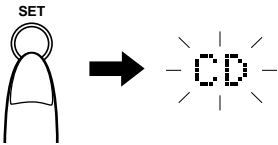

9 Turn the MULTI JOG dial to set the function to CD or CDR.

10 Press the SET button.

- This display appears when the DAILY TIMER play mode is set.

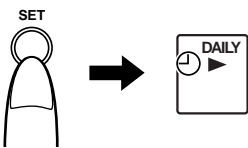

The timer programming is displayed once, and then the function display is restored.

- When “REC” flashes, turn the MULTI JOG dial until “PLAY” flashes.

11 Turn the power to standby.

The present time now appears in the display window.

Notes

- Timer functions cannot be performed if the unit is on when the set time arrives. Make sure that the unit is put in standby for timer functions to operate.
- Match the connected receiver or other source with the unit’s setting, and adjust the volume to the appropriate level. Match the timer with the unit’s timer setting.
- Timer play starts at the programmed start time, and the power is switched to STANDBY at the programmed end time.

Clearing a timer operation

Press the CLOCK/TIMER button, select the timer mode, and press the CANCEL button. “DAILY OFF” or “ONCE OFF” appear in the display, the DAILY ► (or ONCE ►) indicator is cleared, and the timer operation is also canceled.

Timer Recording (unattended recording of the sound from a broadcast receiver or other component)

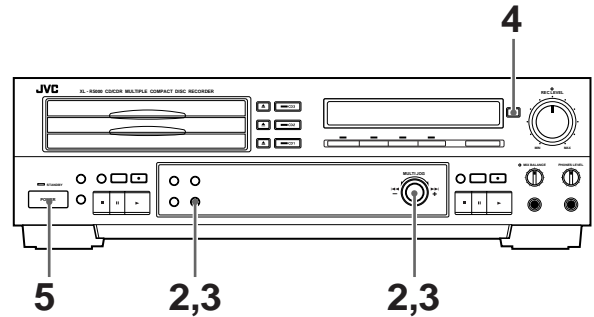

- 1** Perform steps 1 to 7 of the procedure described in “Timer Play (wake-up play)” on page 34.
- 2** While “PLAY” is flashing, turn the MULTI JOG dial to select “REC?” and press the SET button.

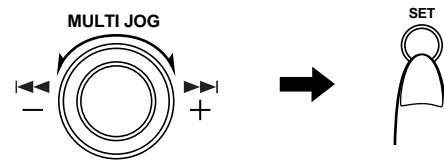

- 3** Turn the MULTI JOG dial to select the sound source to be recorded, and press the SET button.

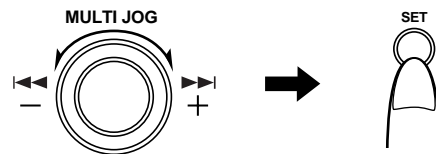
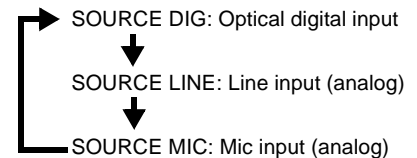

- 4** Load a recordable CD-R or CD-RW in the CDR.
- 5** Turn the power to standby.

The present time now appears in the display window.

Notes

- Match the timer of the connected source with the unit's setting. (In the case of the mic input, ensure that the microphone has been connected to the unit.)
- Recording starts at the programmed start time, and the power will be switched to STANDBY at the programmed end time. When operation is completed once in the ONCE TIMER mode, the timer programming is cleared.
- If digital signals are not supplied when timer recording has been started with digital input signals, "UNLOCK" is displayed and no signals will be recorded.
- When using the timer to record a digital satellite broadcast program, for instance, check that the broadcast station with the desired program can be tuned in correctly before programming the timer start and end times.

COMPU LINK Function

What is COMPU LINK?

The COMPU LINK remote control system (or, simply, “COMPU LINK”) serves to enable the kind of simple operations provided by an integrated system to be performed even though this unit is a separate component.

These simple operations can be performed by connecting the COMPU LINK-4 SYNCHRO, COMPU LINK-3 SYNCHRO or COMPU LINK-1 SYNCHRO connector on each of the components involved.

Connections

Accessory connecting cables

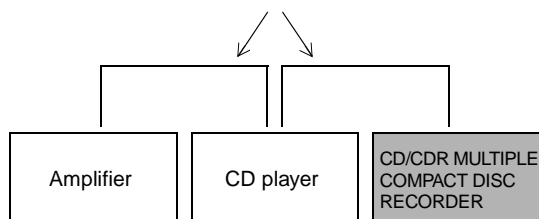

The COMPU LINK functions provided with JVC products come in the form of COMPU LINK-4, COMPU LINK-3 or COMPU LINK-1. They are compatible, and the difference between them is that COMPU LINK-3 has the functions of COMPU LINK-1 with some additional functions as well.

COMPU LINK functions compatible with this unit

Automatic power on/standby

Selecting a source on the amplifier/receiver automatically turns on the relevant component. Similarly, turning a linked component on or standby automatically turns the amplifier/receiver on or standby.

Automatic source selection

Selecting a source on the connected amplifier/receiver automatically starts its operation. Similarly, starting operation of a linked component will automatically select the relevant source on the amplifier/receiver.

When this unit is selected as the source, a selected tray (3CD or CDR) will start to play.

Notes

- The type of interactive operation described above requires that your JVC amplifier/receiver feature COMPU LINK-4, or it will not be compatible with this unit (the CDR will not be recognized by previous COMPU LINK versions). When your JVC amplifier/receiver does not feature COMPU LINK-4, set the COMPU LINK MODE switch on the rear panel of this unit to “TD”, and make connections to the tape deck connectors on the amplifier/receiver. Doing this enables you to use this unit with the COMPU LINK functions, however, COMPU LINK control of a cassette deck will no longer be possible.
- Synchro recording using the compu link is not compatible with this unit.

CD and CDR Messages

CD Messages

| Message | Significance | Remedy |
|---|--|--|
| CD * NO DISC (* indicates the disc tray number) | There is no disc in the selected tray, or a CD-R or CD-RW that has not yet been finalized (including blank discs) has been inserted. | Insert a CD or a CD-R or CD-RW that has been finalized. |
| CD * DISC NG (* indicates the disc tray number) | Disc related trouble has occurred and the disc in the selected tray cannot be played. | Replace the disc. |
| ALL SKIP TR | All the tracks on the disc have TRACK SKIP markers. (Depending on the playback function, playback may proceed to the next disc without displaying anything.) | Replace the disc with one that contains tracks that can be played. |

CDR Messages

| Message | Significance | Remedy |
|---------------|--|--|
| OPC ERROR | OPC adjustments cannot be done to comply with the disc loaded in the CDR. When this occurs, record and erase functions are not possible. (Playback is possible.) | Replace the disc with a CD-R or CD-RW that can be recorded on. |
| OPC FULL | Although time remains on the disc, the PCA area is full, preventing further recording and erasing. (Playback is possible) Recording is possible if the disc has been recorded on by another unit and the adjustment information has been maintained. PCA is an abbreviation of Power Calibration Area. | Replace the disc with a CD-R or CD-RW that can be recorded on. |
| CDR NO DISC | A CD, CD-R or CD-RW has not been inserted. | Insert a CD, CD-R or CD-RW. |
| BLANK DISC | A CD-R or CD-RW with nothing recorded on it has been inserted. Playback and erase functions are not possible. | |
| CDR DISC NG | Disc related trouble has occurred and the disc in the tray cannot be played or recorded on. | Replace the disc. |
| PMA FULL | Although time remains on the disc, the PMA area is full, preventing further recording. PMA is an abbreviation of Program Memory Area. | Replace the disc with a CD-R or CD-RW that can be recorded on. Finalization of the disc is recommended. |
| NO R/RW DISC | A CD-R or CD-RW disc has not been inserted. | Insert a CD-R or CD-RW. |
| ALREADY FINAL | The disc loaded in the CDR is a finalized CD-R or CD-RW | When using a CD-RW, perform the unfinalize function to allow further recording. |
| NO AUDIO DISC | The disc inserted is not for music. | Replace with a disc intended for music. |

| Message | Significance | Remedy |
|---------------|---|--|
| CD-ROM DISC | The inserted disc is a CD-ROM. Record and erase functions are not possible. | Replace with a disc recorded for audio format. (CD-DA) |
| DISC FULL | The CD-R or CD-RW has no available time. | Replace with another recordable CD-R or CD-RW. Finalization of the disc is recommended. |
| TNO FULL | 99 tracks have been recorded on the disc. Further recording is not possible. | Finalize the disc. Replace the disc to perform further recording. |
| CANNOT REC | Recording is not possible. This may be caused by poor connections or disc trouble. | Check connections and/or replace the disc. |
| NO REC SOURCE | No recording source has been selected. | Select a recording source. |
| UNLOCK | When performing digital recording of an external component, the digital signal from the component is not being sent or the signal being sent cannot be recorded by this unit. | Check the connection between the component and this unit and confirm that the digital signal being output from the component is compatible with this unit. |
| SCMS PROTECT | In accordance with SCMS regulations, digital recording cannot be performed. | Switch the source selection to select input from the analog connections, and perform analog recording. |
| NOT AUDIO IN | The digital signal is not an audio format. | Set the source component to output a digital audio signal. For example, if a data track on a CD is selected, switch to a track that contains audio data. |
| NOT REC MUTE | The REC MUTING button has been pressed at a time when the function cannot be performed. | See page 19 for information on when the muting function can be used, and press the REC MUTING button when the function can be performed. |
| SHORT REMAIN | Not enough time remains on the disc to continue synchronized recording from the 3-CD changer to the CDR. | Replace the disc with a disc that contains sufficient recording time. |
| CANNOT FIN | Trouble with the CD-RW has prevented finalization from being performed. | Replace the disc |
| NO RW DISC | A CD-RW has not been inserted. Erase and unfinalize functions are not possible. | |
| CANNOT ERASE | Trouble with the CD-RW has prevented an erase function from being performed. | Replace the disc |
| CANNOT UNFIN | Trouble with the CD-RW has prevented the unfinalize function from being performed. | Replace the disc |
| DAO DISC | The UNFINALIZE function cannot be performed with discs recorded using the "DISC at Once" recording system. | |
| SKIP FULL | The maximum number of 21 tracks on the disc that can be skipped has been reached. Skip marking more than 21 tracks is not possible with this unit. | |

Restriction on Copying Digital Material

Due to copyright and other considerations, the following restriction is now in place for CD-R and CD onto which the digital signals of CDs have been copied.

SCMS (Serial Copy Management System)

The digital quality of CDs and other digital media can be recorded to CD-R and CD-RW using the CDR function of this unit. However, it is not possible to make a second generation digital copy from a first generation copy. This restriction, known as SCMS (Serial Copy Management System), is intended to prevent unlimited digital copying in the interests of artists and other copyright holders.

This unit is designed to comply with SCMS restrictions.

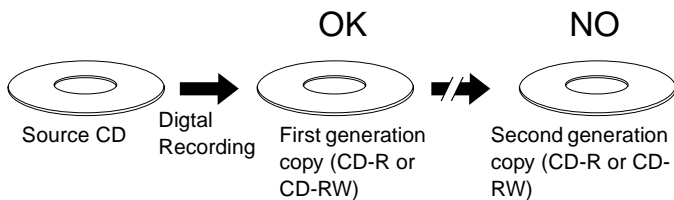

The copyright laws allow recordings to be made for the personal enjoyment of the individual user but they do not allow such recordings to be used for other any purposes without permission from the holder of the copyrights.

Note

- If digital recording of a first generation digital copy is attempted, "SCMS PROTECT" appears in the display window, and the recording operation is canceled.
- In the case of Synchronized Recording, Listening Edit Recording and Program Edit Recording, when the first generation copy is a finalized CD-R or CD-RW loaded in the 3-CD changer, the recording type is automatically changed from digital to analog, and the recording type indicators light accordingly. (If high speed dubbing was turned on, it will be turned off when the recording type is changed.)

Troubleshooting

| | Symptom | Cause | Remedial action/check | Ref |
|----------------|---|--|---|-----|
| COMMON | No sound. | <ul style="list-style-type: none"> A CD-R or CD-RW with nothing recorded on it has been inserted. ("BLANK DISC" is displayed.) | <ul style="list-style-type: none"> Replace the disc with one on which tracks have been recorded. | |
| | The time display flashes in the display window. | <ul style="list-style-type: none"> A power failure has occurred or the power cord has been disconnected. | <ul style="list-style-type: none"> Set the clock and re-program the timer. | 33 |
| CD PLAYER | Play fails to start | <ul style="list-style-type: none"> The CD has been inserted upside down. | <ul style="list-style-type: none"> Insert it properly with the label side facing up. | 11 |
| | | <ul style="list-style-type: none"> Condensation has formed on the lens. | <ul style="list-style-type: none"> Turn on the power and wait for a couple of hours. | 2 |
| | Specific parts are not played properly. | <ul style="list-style-type: none"> The CD is scratched. | <ul style="list-style-type: none"> Replace the CD. | 11 |
| CDR | Recording is not possible | <ul style="list-style-type: none"> The CD-R or CD-RW was loaded in the tray upside-down. | <ul style="list-style-type: none"> Load the disc with the label side up. | 12 |
| | | <ul style="list-style-type: none"> The CD-R or CD-RW is already finalized. Further recording on a finalized CD-RW is only possible if the UNFINALIZE function is used. | <ul style="list-style-type: none"> Replace with a disc that can be recorded on. | 29 |
| | | <ul style="list-style-type: none"> The source being copied is already a digital copy itself. | <ul style="list-style-type: none"> Perform analog recording of the source. | 18 |
| | | <ul style="list-style-type: none"> There is dust or scratches on the surface of the disc. | <ul style="list-style-type: none"> Clean the disc using a commercially available disc cleaner. If this is not effective, replace the disc. | 18 |
| TIMER | Timer fails to start. | <ul style="list-style-type: none"> Present time is not correct. The timer display fails to appear. | <ul style="list-style-type: none"> Set the time properly. Press the TIMER button so that the timer display appears. | 33 |
| REMOTE CONTROL | No remote control operations. | <ul style="list-style-type: none"> The dry batteries in the remote control have discharged. | <ul style="list-style-type: none"> Replace them with two fresh batteries (AA (15F), R6, SUM-3). | 9 |
| | | <ul style="list-style-type: none"> The remote control sensor is exposed to direct sunlight or some other intense source of light. | <ul style="list-style-type: none"> Move the unit so that the sensor is not exposed to direct sunlight, a lighting fixture or some other intense source of light. | 9 |

If the unit fails to operate properly even when the remedial action suggested above has been taken:

This unit uses a microcomputer to perform a large number of operations. If it fails to operate no matter which button is pressed, disconnect the power cord, and then wait a few moments before re-connecting it. Then set the time and re-program the timer.

Notes

- If something important is going to be recorded, always test-record first to check that the recording turns out properly before proceeding with the actual recording.
- The manufacturer assumes no liability whatsoever for any damages resulting from missed opportunities or accidental erasure that occurs while conducting recording or play operations due to malfunctioning of or trouble in the unit, or for any incidental damage.

Main Specifications

The unit's specifications and exterior are subject to change without notice due to improvements.

CD Player Section

| | |
|---------------------------|-----------------------------------|
| System | Compact disc digital audio system |
| Pitch control | ±12% |
| Signal-to-noise ratio | 94 dB |
| Dynamic range (1 kHz) | 91 dB |
| Frequency response | 20 Hz ~ 20 kHz |
| Wow and flutter | Less than measurable limit |
| Total harmonic distortion | 0.0063% |

CDR Section

| | |
|---------------------------|--|
| System | Compact disc digital audio recording system |
| Sampling frequency | 44.1 kHz |
| Frequency response | 20 Hz ~ 20 kHz |
| Inputs: Analog (LINE IN) | Minimum input level: 300 mV (Full scale -12 dB)/50 kΩ |
| Digital (optical) | Input level: -23 dBm ~ -15 dBm (With sampling rate 32 KHz/44.1 KHz/48 KHz) |
| Microphone | Minimum input level: 3 mV (Full scale -12 dB)/600 Ω ~ 10 kΩ matching impedance |
| Signal-to-noise ratio | 97 dB (during playback) |
| Dynamic range (1 kHz) | 93 dB (during playback) |
| Wow and flutter | Less than measurable limit |
| Total harmonic distortion | 0.0042% (during playback) |

Timer Section

| | |
|---------------|---|
| Timer system | DAILY TIMER operation (ON/OFF timer) ONCE TIMER operation (ON/OFF timer) |
| Clock display | 12-hour display (for Caranda and U.S.A.) 24-hour display (for other countries) |

Common Specifications

Output connectors:

Analog
LINE x 1 set, 2 V/5 kΩ (Full scale)
Headphones x 1, 4 mW/32 Ω, 8 Ω ~ 1 kΩ matching impedance

Digital
OPTICAL x 1, -21 dBm ~ -15 dBm

Other connectors
COMPU LINK-4/SYNCHRO x 2

Power requirements
AC 120V ~, 60 Hz (for Canada & USA) AC 230V ~, 50Hz, (for UK)
AC 110V/127V/230V, 50Hz/60Hz (for other countries)

Power consumption
29 W in power ON mode; 6 W in STANDBY mode

Dimensions
435 mm x 127 mm x 325 mm (W x H x D)

(17-3/16'in x 5'in x 12-13/16'in)

Mass
Approx. 6.3 kg (13.9 lbs)

Accessories

Remote control (RM-SXLR5000J, for Canada & USA), (RM-SXLR5000E, for other countries)(1)

AA(15F), R6, SUM-3 dry batteries (to check operation of remote control) (2)

Pin cables (2)

COMPU LINK-4 cable (1)

Mains (AC) Line Instruction (not applicable for Europe, U.S.A., Canada, Australia and U.K.)

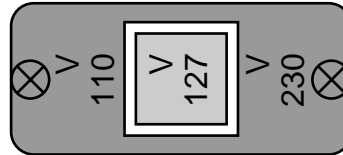
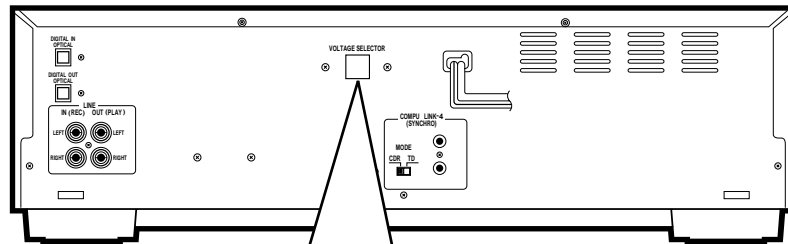

CAUTION for mains (AC) line
BEFORE PLUGGING IN, do check that your mains (AC) line voltage corresponds with the position of the voltage selector switch provided on the outside of this equipment and, if different, reset the voltage selector switch, to prevent from damage or risk of fire/electric shock.