

FOXDA

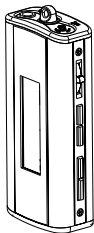

FM-6605

User Manual

Digital Mp3 Player

Thank you for purchasing Foxda's MP3 player. Please read through the user manual carefully before operating the machine in order to maximize the ability and life of our product. Please take good care of this manual for future reference. The appearance of our players shown in the manual may differ from the actual products since all pictures are based on the prototype of our models.

As some components would take up spaces in the flash memory, it is normal to find out that the available memory size is lesser than normal.

CE FCC Tested To Comply
With FCC Standards
FOR HOME OR OFFICE USE



This device complies with Part 15 of the FCC Rules. Operation is Subject to the following two conditions: (1) this device may not cause harmful interference received, including interference that may cause undesired operation.

Content

Note.....1

Overview

MP3 Player.....3
LCD.....4
Earphone.....4
Features..... 5
Technical Spec.....6
Operational Notes.....7

Operational Notes

Battery/Power on or off.....9
Operation MODE..... 10
Music..... 11-14
Voice..... 15-16
FM tuner.....17-19

Communication with Computer

Connection.....21
Installation.....22
Download.....23-24
Disconnection.....25
Formatting.....25

OVERVIEW

This player is an MP3 player with removable storage hard disk and fashionable appearance. It is user-friendly, easy to operate and provides recoding, music playing and repeating function.

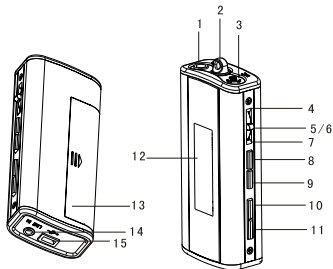

Player overview

- | | |
|------------------------|-------------------|
| 1. Earphone Jack | 9. REC/A-B/EQ |
| 2. Neck Strap Loop | 10. VOL- |
| 3. Internal Microphone | 11. Vol + |
| 4. RW | 12. LCD |
| 5. PLAY | 13. Battery Cover |
| 6. STOP | 14. CD Line-in |
| 7. FF | 15. USB port |
| 8. FUNCTION | |

Note: Press 8&9 Buttonto enable the "hold"function.

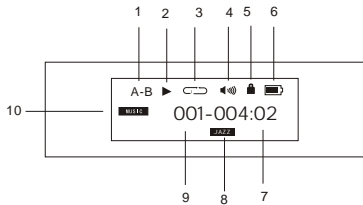

LCD

- 1.Repeat A-B display
- 2.Status indicator
- 3.Play mode display
- 4.Volume
- 5.Hold Status
- 6.Power
- 7.Current music playing time
- 8.EQ
- 9.Song number
- 10.Function

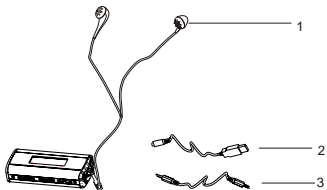

Earphone overview

- 1.Ear piece
- 2.USB cable
- 3.CD Line-in

Accessories

- | | |
|-------------|--------------------|
| 1.USB cable | 4.CD-ROM |
| 2.Earphone | 5.Neck Strap |
| 3.Manual | 6.CD Line-in cable |

Features:

- “ Online FM recording
- “ CD Line-in

- “ Playback MP3/ WMA multi-format files
- “ Equalizer mode options: Normal, Class, Jazz, Pop, Rock, DBB.
- “ LCD display, blue light background.
- “ A-B repeatfunction
- “ 10 hours recording time (128MB)
- “ 12MB full speed USB internal flash memory
- “ Low power consumption, AAA battery (12 hrs continuous playback time)
- “ No driver required for windows me/2000/xp (except Windows 98SE)
- “ Compact and light in Weight, Stylish appearance

Data reference

Size	69 x31 x 16 mm
Weight	25 g
Power Source	1.5V "AAA" Alkaline Batt.
Encode	ISO 11172-3 (MPEG 1.0 Layer 3)
Bit Rate	64 kdps - 320 kdps
Frequency	8 KHz - 48 KHz
Frequency Range	(+ -1db) 20Hz - 20KHz
Distortion	(1KHz) 0.1%
SNR	>80 db
MP3 (Sound Track Separation)	>80 db
MP3 (Dynamic Range)	>93 db
Recorder Length	16 bit
Transfer Speed	12Mb Full Speed USB
Delivery Speed	4Mbps
Power	Out>5mW*2

Operational Notes

- “ If the MP3 player will not be operated for a prolonged period, remove the battery to avoid possible damage caused by electrical leakage.
- “ The MP3 player should be kept in areas free from extreme temperature changes, moisture and dust.
- “ Set the HOLD switch to release position before operation
- “ Do not drop the player
- “ Battery life may vary depending on usage condition and manufacture date.
- “ Please change the battery under Low Battery indicator displayed. (All buttons are not responding even after the battery has been taken out and replaced)
- “ Do not use the player for a very long period in order to protect your audio ability
- “ If the player stops running under proper operation, please reset by taking out battery.
- “ Do not use layer when driving or cycling.
- “ The optimum temperature for operation is 5 -45 degree Celsius (41F -95F) with humidity between 10% and 75 %.

FOXDA

Operating Instructions

Load battery

Open the battery compartment and load one AAA7 battery as directed by "+" and "-"



Change battery

When the LCD displays "Low Battery" it indicates a need of battery change. Turn off the machine before replacing a new battery.

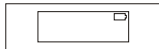

Turning the power on/off

The "HELLO" greeting appears when "⏻" button is pressed. The length of time for the backlight to stay on is depending on user preference.

Switching the power off by pressing on the "▶\■" button continuously. "BYE BYE" will appear on the screen before the machine has switched off.

HELLO

FREE 108

BYE BYE

Functional Options

Music playing, voice playing & recording, radio function

Press "Function" to enter music mode (default setting). You can play Mp3 and WMA format files in this mode.



Press "Function" button again to enter voice mode.



Press "Function" button again to enter FM Tuner mode.



Music playing functions

The default OSD is in stop status under music mode

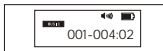

■ Play/Pause/Stop/FF/RW

Press Play/Stop button to play, LCD displays as:



Press Play/Stop button again to pause playing. LCD displays as:



Under pause mode, press down Play/Stop button for 3 seconds to jump to stop mode, and press Play/Stop button again to return to playing music mode, LCD displays as:



Press FF button to select next song. Press RW button to select previous song.

Note: Only in stop mode, hold play/stop button to switch off the machine. If the machine is playing, please stop playing first before switching off.

■ VOL+/VOL-

By pressing VOL+/VOL- button, you could control the volume under either Player Pause mode. The volume steps (see illustration) will increase or decrease when the VOL+/VOL- button is pressed correspondingly.



■ Repeat A-B function

Under music/voice mode, you can press A-B/EQ button to select A and B, then A-B music or voice will play continuously. Press A-B/EQ button to cancel, LCD displays as:

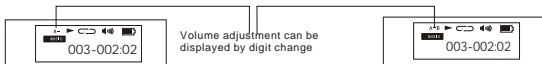

Remark: Under stop mode, this function is out of operation. Press A-B/EQ/REC for a period of time to change into EQ setting.

■ EQ setting

Under the playing mode, press A-B/EQ button for a period of time to select 6 different music modes: Normal, DBB, Jazz, Rock, Classical, and Pop. LCD displays as:

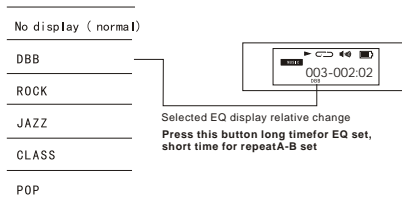

■ Music playing mode:

Press "FUNCTION" for a while to enable the repeat playing function.

There are five playing mode:

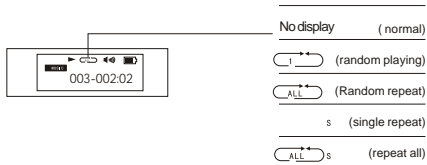

■ Interpreting the message regarding music file and voicefile

When in play/stop status, the display will show the number of music or voice file, e.g. 003. After the file number is the current playing time of the music or voice file. The total time for the music and voice file is shown at the beginning when the file starts playing (for 1 second)



1.The file number of music or voice file
2.Current playing time/ file total time

■ Erasing a music file

Under “STOP” mode, press “FUNCTION” and “+” at the same time, then you will see the following appeared on the screen:

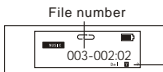

Press “▶▶” “◀◀” to choose Yes or No.
Press Stop/play to confirm, or press other key to cancel.

When the file has been erased, the display will show as follows:



■ Voice mode

Under music mode, press “FUNCTION” button to enter voicemode. Under voice mode, you can select play/record/repeat/A-B/RW/FF/V+,-/EQ setting.

1. Play/RW/FF/V+,- (details canbe found in musicmode)

2. **Recording: One of themain functions for thisplayer**

Under voice mode instop status:

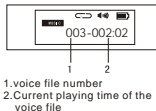

- 1.voice file number
- 2.Current playing time of the voice file

Start Recording

Under Voice Function,press “A-B/EQ” button and you willsee that “REC MIC ” has appeared on the screen. Press “A-B/EQ” again to start recording.Display is the sameas follows:



At the mean time,if you press▶▶ and◀◀during “REC MIC” appeared on the screen,the CD line-in function webe activated. Under CDline-in mode, press “A-B/REC” to start the file transfer from CDto Mp3 player.The screen will showthe same display asabove

Note: Under “CD Line in” function, to prevent voice distortion you can adjustthe volume properly.

- 1.Recording status
- 2.Remaining recording time
- 3.Current recording time



Stop Recording

Press "A-B/EQ" button again to stop recording. Display is shown below



Play / Recording

The operating procedure is the same as playing normal music files

Remarks: "A-B" repeating function can only function in play/stop status. "EQ" mode can only be changed by pressing the "A-B/EQ" button under play/stop/pause status. It cannot function in recording mode.

Erase voice files

Under "STOP" status of voice mode, press "FUNCTION" and "+" at the same time, then you will see the following appeared on the screen:

File number



Press "▶▶" , "◀◀" to choose Yes or Number
Press Stop/play to confirm, or press other key to cancel.

After the file has been erased, the following word will be shown on the screen.



FM tuner function

■ Enter FM tuner mode

Press “Function” button to enter FM tuner mode. (Adjust the direction of earphone line to get better radio effect)

■ VOL+/VOL-



■ Auto search

Press “Function” button for a while to auto search and memorize radio channels. When the LCD displays “SFARCH” (fig. 1), you can not cancel its operation until the auto search has finished. When the searching process has finished, the screen will show the first channel and how its frequency (fig. 2). RVHC can memorize radio channels as many as 32 channels.



(1)



(2)

■ FM fine tuner

Press **▶▶** or **◀◀** to fine tune. By pressing “A-B/EQ” button for a moment, the machine will memorize the current radio frequency. If you want to repeat the auto search function, press stop/play button until **▶\■** appeared on the screen, then press **▶▶** or **◀◀** to activate the auto search function again. Similarly, if you want to fine tune any channels, you only need to press play/stop button once till the **▶\■** disappeared from the screen. You may now fine tune the channel by press the “A-B/EQ” button for a while.



When “P” appears on the screen, you can select the memorized channel: Stereo may appear according to the strength of signal. IFM Recording

■ FM record

Press “A-B/EQ” button to start recording the current listening radio channel. The display is shown below:



Press the same button again to stop recording. You can play the recorded file in voice mode. The display is shown below:

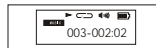

■ Playing recorded FM files

Press "FUNCTION" button to return to voice playing mode. Press ►| and |◄◄ to search for the recorded or **Line in** files and press play button to play the file. You can treat the files as common music files to run EQ setup and other related functions

■ Operation of FM files in PC

When the USB connection between the mp3 player and PC has completed, you can find that there is a folder called "FM" in the player. Inside you can find the recorded FM files. Just like other music files, you can rename, copy or delete the Recorded FM files.

■ Quit FM Tuner mode

Press "FUNCTION" button to quit FM tuner mode and back to music or voice mode.

■ EQ Configuration: 6 different EQ modes (please refer to p13 for configuration)

■ In order to lower the power consumption, this machine is designed to auto power-off if it has been idled for 1 minute.

■ The default backlight on time is 10 seconds. When you are operating the player, the backlight will turn on for 10 seconds.

FOXDA

CONNECTION WITH COMPUTER

■ Requirements for computer system

1. Operating systems: Microsoft Windows 98 SE, Windows Me, Windows 2000, Windows NT, Windows XP
2. CPU: Intel Pentium 3, Pentium 4 or above CPU
3. Memory: 64 MB or above
4. HD: 200 MB free space and above
5. Interface: full-speed USB
6. CD-ROM

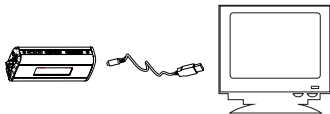

■ Connection with computer

Connect the USB cable with the computer USB port.

■ Installation of Driver

After connecting with computer, Windows 2000/ME/XP will automatically identify and install the driver. The machine is ready to use when a "Removable drive" icon appears in "My computer". The attached CD-ROM is needed for Windows 98 to install Driver.

The icon will be displayed in "My computer" after installation



The icon will be displayed here after installation

Windows 98 SE installation

Put the attached CD-ROM into computer, and then install the software according to instruction.



Computer difference can display some changes

■ Upload/download files

The operation for this player is just like other USB storage device, you can copy file to related file folder, or to rename it for the sake of better understanding of song title during playing or recording.

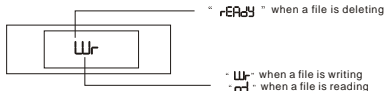

After the machine has connected with a PC, choose the files that you want to copy and drag it to the removable device folder (mp3 player). The saved files will play according to their file names. If you want to change their order of playing, please change their file names (Please refer to next page)

Remarks: During the process of uploading/downloading files, “WRITE/RD” will be shown on the screen. If you unplug the cable at this time, it may cause errors to the files.

Naming of files

When no files LCD display as:



For large amount of music/voice/recorded files, users may define the file names according to their own preference.

■ Save and rename music and voice files

After successful connection between the machine and computer (switch on), it is displayed as:

Double-click removable disk, it is displayed as

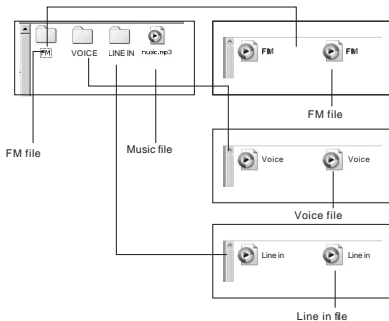

Note: This machine can recognize and play mp3 and WMA format files.

■ Disconnection with computer

Right click “Plug and play” icon then select “Safe to delete” to disconnect.



Note: Do not unplug themachine with computer with the file isread/written/deleted. Foxda Technology is notliable for any damage/lose of any files.



■ Formatting

Right click the “removable disk” icon then select “FAT” mode to format. Themachine may not beable to play music if “FAT32” or “NTFS” mode selected. To recover, pleaseformat the machine aginas “FAT” mode.



Press "Begin" button

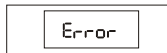

FOXDA
WWW.FOXDA.COM

Foxda Technology Industrial(Shenzhen) Co. Ltd

Sales Office:

**Add: 6/F, Fuxing Bldg,Binlang Road, Futian Free Duty Zone,
Shenzhen, 518038, CHINA.**

Tel: (852) 2521-6669 Fax:(852) 2521-2229

Factory:

**Add: E/Flat, New Century Industrial Park,
Longgang Large Industrial Zone,
Shenzhen, 518118, CHINA**

Tel: 86-755-84637555 Fax: 86-755-84637700

Hong Kong Office:

**Add: Unit 1205, Tower 1, Lippo Centre, Admiralty Hong KongTel: (852)
2521-6669 Fax: (852) 2521-2229**

<http://www.foxda.com>