



USER'S GUIDE

V:2316-0218-09

IC609

Intelli Set™ Clock Radio with Dock for iPod

CONTENTS

WARNINGS AND PRECAUTIONS	2
IMPORTANT SAFETY INSTRUCTIONS	2
» QUICK START	3
PLAYING A DOCKED IPOD	3
TUNING THE AM/FM RADIO	3
GENERAL PRODUCT INFORMATION	4
IN THE BOX	4
FEATURES	4
POWERING THE UNIT & REMOTE	5
UNIT POWER OPTIONS	5
REMOTE POWER OPTIONS	5
OPERATIONS	6
SETTING THE CLOCK USING INTELLI SET™	6
SETTING THE CLOCK MANUALLY	6
SETTING THE ALARM	7
USING THE DAYLIGHT SAVINGS TIME FEATURE	7
DOCKING AN IPOD TO THE UNIT	8
PLAYING A DOCKED IPOD	8
TUNING THE AM/FM RADIO	9
SAVING AN AM OR FM STATION AS A PRESET	9
USING THE AUXILIARY INPUT	9
UNIT CONTROLS & FEATURES	10
UNIT CONTROL GLOSSARY	11
REMOTE CONTROLS & FEATURES	12
REMOTE CONTROL GLOSSARY	13
REMOTE CONTROLS & FEATURES	14
REMOTE & LCD CONTROL GLOSSARY	15
COMPANY INFORMATION	16
GREEN INITIATIVE	16
INTERNATIONAL SUPPORT	16
SERVICE INFORMATION	16

WARNINGS AND PRECAUTIONS

- CAUTION: USE OF ANY CONTROLS, ADJUSTMENTS, OR PROCEDURES OTHER THAN THOSE SPECIFIED HEREIN MAY RESULT IN HAZARDOUS RADIATION EXPOSURE.
- CAUTION: DANGER OF EXPLOSION IF BATTERY IS INCORRECTLY REPLACED. REPLACE ONLY WITH THE SAME OR EQUIVALENT TYPE.
- TO PREVENT FIRE OR SHOCK HAZARD, DO NOT USE THIS PLUG WITH AN EXTENSION CORD, RECEPTACLE OR OTHER OUTLET UNLESS THE BLADES CAN BE FULLY INSERTED TO PREVENT BLADE EXPOSURE.
- WARNING: TO REDUCE THE RISK OF FIRE OR ELECTRIC SHOCK, DO NOT EXPOSE THIS APPLIANCE TO RAIN OR MOISTURE.
- WARNING: THE BATTERIES SHALL NOT BE EXPOSED TO EXCESSIVE HEAT SUCH AS SUNSHINE, FIRE OR THE LIKE.



The lightning flash with arrowhead symbol, within an equilateral triangle, is intended to alert the user to the presence of uninsulated "dangerous voltage" within the product's enclosure that may be of sufficient magnitude to constitute a risk of electric shock to persons.

CAUTION

RISK OF ELECTRIC SHOCK
DO NOT OPEN

WARNING: TO REDUCE THE RISK OF ELECTRIC SHOCK, DO NOT REMOVE COVER (OR BACK). NO USER-SERVICEABLE PARTS INSIDE. REFER SERVICING TO QUALIFIED SERVICE PERSONNEL.



The exclamation point within an equilateral triangle is intended to alert the user to the presence of important operating and maintenance (servicing) instructions in the literature accompanying the appliance.

IMPORTANT SAFETY INSTRUCTIONS

1. Read these instructions.
2. Keep these instructions.
3. Heed all warnings.
4. Follow all instructions.
5. Do not use this apparatus near water.
6. Clean only with dry cloth.
7. Do not block any ventilation openings. Install in accordance with the manufacturer's instructions.
8. Do not install near any heat sources such as radiators, heat registers, stoves, or other apparatus (including amplifiers) that produce heat.
9. Do not defeat the safety purpose of the polarized or grounding-type plug. A polarized plug has two blades with one wider than the other. A grounding type plug has two blades and a third grounding prong. The wide blade or the third prong are provided for your safety. If the provided plug does not fit into your outlet, consult an electrician for replacement of the obsolete outlet.
10. Protect the power cord from being walked on or pinch particularly at plugs, convenience receptacles, and the point where they exit from the apparatus.
11. Only use attachments/accessories specified by the manufacturer.
12. Use only with the cart, stand, tripod, bracket, or table specified by the manufacturer, or sold with the apparatus. When a cart is used, use caution when moving the cart/apparatus combination to avoid injury from tip-over.
13. Unplug this apparatus during lightning storms or when unused for long periods of time.
14. Refer all servicing to qualified service personnel. Servicing is required when the apparatus has been damaged in any way, such as power-supply cord or plug is damaged, liquid has been spilled or objects have fallen into the apparatus, the apparatus has been exposed to rain or moisture, does not operate normally, or has been dropped.
15. This appliance shall not be exposed to dripping or splashing water and that no object filled with liquid such as vases shall be placed on the apparatus.
16. CAUTION: Visible and Invisible Laser Radiation when open and interlock defeated.
DO NOT STARE INTO BEAM.
17. Rating label is located at the bottom of enclosure.
18. "CAUTION" mark is also located at the bottom of enclosure.



1. Plug the IC609 into an AC outlet.

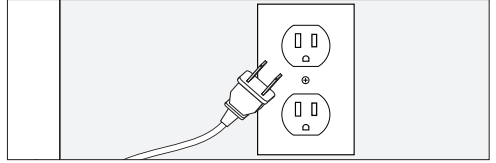
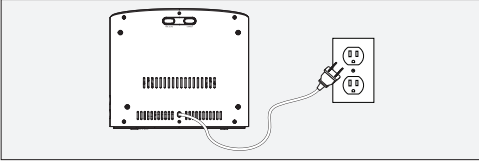

The Intelli Set™ time feature automatically sets the unit's time to Eastern Standard.

2. Press the **Power Button** to turn the unit off.
3. Press and hold the **Clock Adjust Button**.
4. While holding the **Clock Adjust Button** press the **Time Zone Button** to adjust the time zone to your current Time Zone.

Use the map on page 6 to find your time zone.

5. Release the **Clock Adjust Button** to finish setting the clock.

PLAYING A DOCKED IPOD

Connect the correct docking bracket onto the Dock for iPod, and dock the iPod.

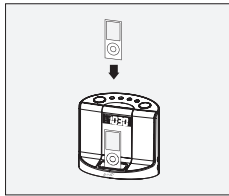
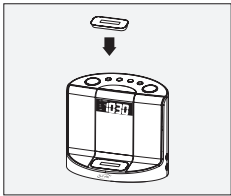

1. Press the **Power Button** to turn the unit on.
2. Press the **Source Button** to switch the unit to *iPod mode*.

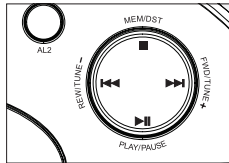
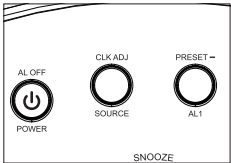

3. Press the **Play/Pause Button** to begin playing the docked iPod through the speakers of the unit.

TUNING THE AM/FM RADIO

1. Press the **Power Button** to turn the unit on.

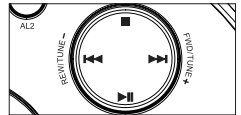
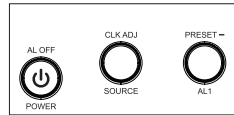

2. Press the **Source Button** to select AM or FM radio modes.
3. Press the **Tune +** or **Tune - Buttons** to tune the AM or FM radio.

Extend the FM wire antenna to improve FM reception.

An AM antenna is built into the unit. Adjust the position of the unit to improve AM reception.

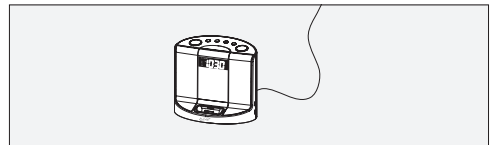

IN THE BOX

IC609 - Intelli Set™ Clock Radio with Dock for iPod

Remote Control

Docking Brackets for iPod (4)

User's Guide & Warranty

- The apparatus shall not be exposed to dripping or splashing and that no objects filled with liquids, such as vases, shall be placed on apparatus.
L'appareil ne doit pas être exposé aux écoulements ou aux éclaboussures et aucun objet ne contenant de liquide, tel qu'un vase, ne doit être placé sur l'objet.
- Main plug is used as disconnect device and it should remain readily operable during intended use. In order to disconnect the apparatus from the mains completely, the mains plug should be disconnected from the mains socket outlet completely.
La prise du secteur ne doit pas être obstruée ou doit être facilement accessible pendant son utilisation. Pour être complètement déconnecté de l'alimentation d'entrée, la prise doit être débranchée du secteur.
- Battery shall not be exposed to excessive heat such as sunshine, fire or the like.
Les piles ne doivent pas être exposées à de forte chaleur, tel qu'à la lumière du soleil, au feu ou autres choses de semblable.
- Caution marking is located at the bottom of apparatus.
Les précautions d'emploi sont inscrites en bas de l'appareil.
- The marking information is located at the bottom of apparatus.
Les marquages sont inscrits en bas de l'appareil.

NOTE: This equipment has been tested and found to comply with the limits for a Class B digital device, pursuant to Part 15 of the FCC Rules. These limits are designed to provide reasonable protection against harmful interference in a residential installation. This equipment generates, uses, and can radiate radio frequency energy and, if not installed and used in accordance with the instructions, may cause harmful interference to radio communications. However, there is no guarantee that interference will not occur in a particular installation. If this equipment does cause harmful interference to radio or television reception, which can be determined by turning the equipment off and on, the user is encouraged to try to correct the interference by one or more of the following measures:

- Reorient or relocate the receiving antenna.
- Increase the separation between the equipment and receiver.
- Connect the equipment into an outlet on a circuit different from that to which the receiver is connected.
- Consult the dealer or an experienced radio/TV technician for help.

FEATURES

Dock plays and charges iPod

Intelli Set™ auto clock set

AM/FM radio with digital tuning

Auxiliary input for iPod shuffle and other audio devices

Dual alarm with gradual wake

Remote

Station memory presets (20 AM, 20 FM)

Preset EQ settings

Last station memory

Mute function

Volume & function last user setting

Stereo headphone jack

Digital clock

Wake to iPod, radio, or buzzer

Snooze & sleep function

Battery backup

Time zone button

Daylight savings time switch

0.8" LCD display with white backlight

Display dimmer control

Two integrated speakers

AC power: AC cord built-in

UNIT POWER OPTIONS

AC Power

Attached AC Cord (included)

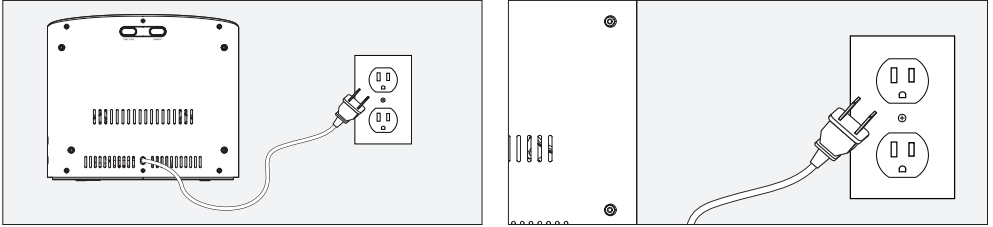

DC Power - Backup Battery

Requires 1 CR2025 battery (pre-installed)

The backup battery is for saving the time during brief power outages. The unit cannot perform any of its normal functions when powered off of the backup battery alone.

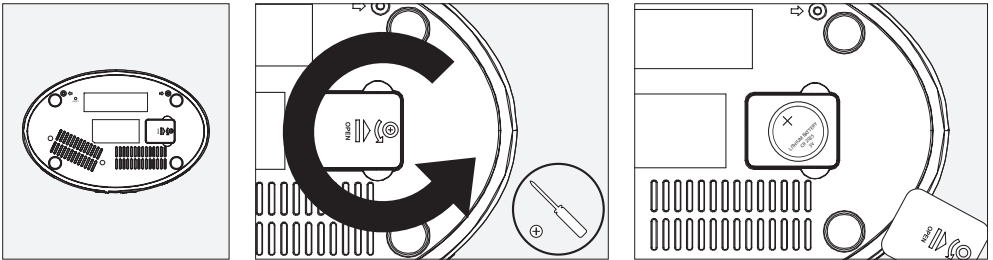

REMOTE POWER OPTIONS

DC Power

Requires 1 CR2025 battery (pre-installed)

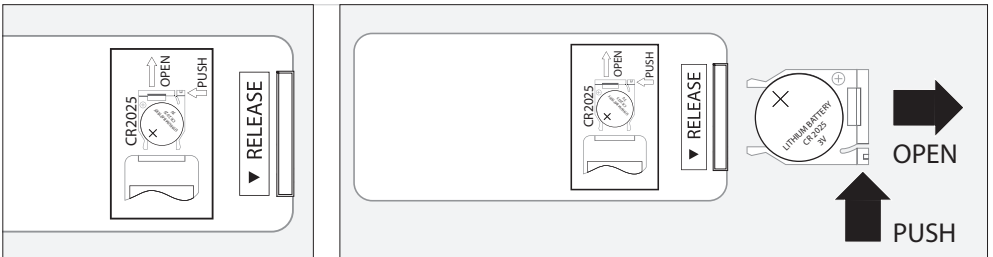

OPERATIONS

SETTING THE CLOCK USING INTELLI SET™

The Intelli Set™ time feature automatically sets the unit's time to Eastern Standard.



1. Press the **Power Button** to turn the unit off.
2. Press and hold the **Clock Adjust Button**.

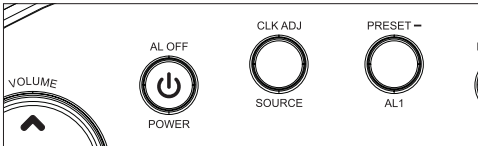

3. While holding the **Clock Adjust Button** press the **Time Zone Button** to adjust the time zone.

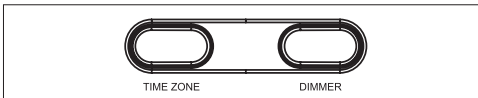

Use the map below to find your time zone.

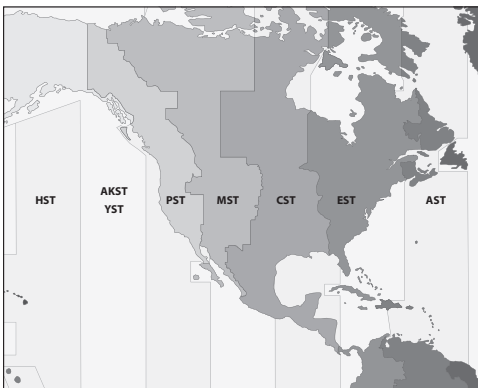

4. Release the **Clock Adjust Button** to finish setting the clock.

SETTING THE CLOCK MANUALLY

Follow the “Setting the Clock Using Intelli Set™” instructions before attempting to set the clock manually.

1. Press and hold the **Clock Adjust Button**.

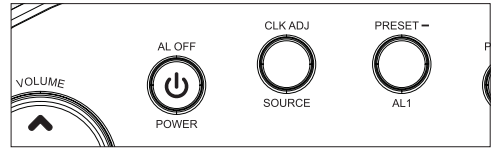

2. While holding the **Clock Adjust Button** press the **Tune - Button** to adjust the hour and the **Tune + Button** to adjust the minute of the time.

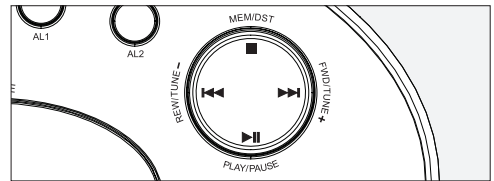

3. Release the **Clock Adjust Button** to finish setting the clock.

SETTING THE ALARM

1. Press and hold the **Alarm 1** or **Alarm 2 Button**.
2. While holding the **Alarm 1** or **Alarm 2 Button** press the **Tune - Button** to adjust the hour and the **Tune + Button** to adjust the minute of the alarm.
3. While holding the **Alarm 1** or **Alarm 2 Button** press the **Source Button** to adjust the alarm source.
 - Buzz- Wake to Buzzer.*
 - Tune FM- Wake to FM radio.*
 - Tune AM- Wake to AM radio.*
 - iPod- Wake to a docked iPod.*
4. Release the **Alarm 1** or **Alarm 2 Button** to finish setting the alarm.

To cancel the alarm, press and hold the **Alarm 1** or **Alarm 2 Button**, and press the **Source Button** repeatedly until the alarm source icon on the display disappears.



LCD Display After Alarms are Set

The above image shows alarm 1 set to sound to the buzzer, and alarm 2 set to sound to a docked iPod.



LCD Display During Setting of Alarm

The above image shows alarm 2 is being set to sound to the AM radio. The time will blink during the setting of the alarm.

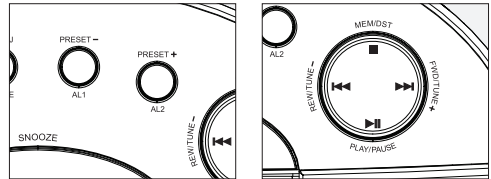

USING THE DAYLIGHT SAVINGS TIME FEATURE

The Daylight Savings Time Feature is meant to be activated in the Spring at the time of the Summer Solstice, and deactivated in the Autumn at the time of the Winter Solstice.

1. At the time of the Summer Solstice, press the **Power Button** to turn the unit off.
2. Press and hold the **Clock Adjust Button**.
3. While holding the **Clock Adjust Button**, press the **Daylight Savings Time Button** to activate the Daylight Savings Time Feature.
4. At the time of the Winter Solstice, repeat steps 1-3 to deactivate the Daylight Savings Time Feature.



DST Activated

The DST should be activated during the Summer Solstice.



DST Deactivated

The DST should be deactivated during the Winter Solstice.

DOCKING AN IPOD TO THE UNIT

1. Locate the numbered bracket that fits the iPod model that will be docked.

Each included bracket has a number on it, indicating which iPod model that bracket is compatible with. See the separate bracket chart page to identify which bracket is needed.

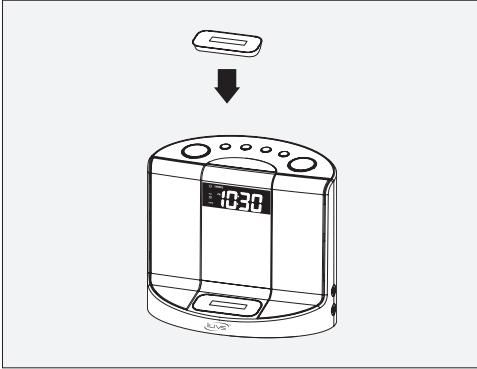

2. Snap the bracket into place over the iPod connector in the dock.
3. Connect the iPod to the iPod connector inside the dock.

When the unit is plugged in, it will charge the docked iPod.

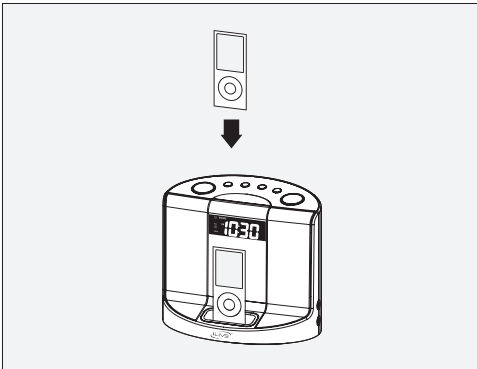

PLAYING A DOCKED IPOD

Follow the directions for Docking an iPod to the Unit.

1. Press the **Source Button** to switch the unit to *iPod mode*.

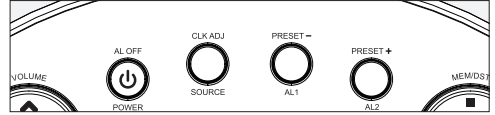

2. Press the **Play/Pause Button** to begin playing the docked iPod through the speakers of the unit.

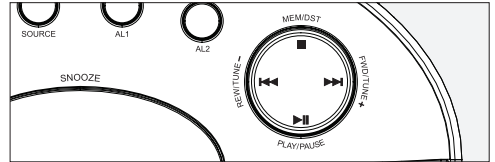

3. Press the **Rewind and Fast Forward Buttons** to skip between tracks on a docked iPod.

Press and hold the **Rewind** and **Fast Forward Buttons** to search through individual songs on a docked iPod.

4. Press the **Play/Pause Button** to pause an iPod during play.

TUNING THE AM/FM RADIO

1. Press the **Power Button** to turn the unit on.
2. Press the **Source Button** to select AM or FM radio modes.
3. Press the **Tune +** or **Tune - Buttons** to tune the AM or FM radio.

Extend the FM wire antenna to improve FM reception.

An AM antenna is built into the unit. Adjust the position of the unit to improve AM reception.

SAVING AN AM OR FM STATION AS A PRESET

Follow the directions for Tuning the AM/FM Radio.

1. After tuning the AM or FM radio to the desired station, press the **Memory Button**.

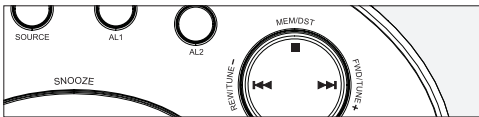

Preset numbers will blink on the LCD display.

2. Press the **Tune +** or **Tune - Buttons** to select a preset number to save the current radio station to.

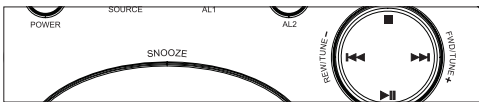

3. Press the **Memory Button** to save the current radio station to the selected preset number.
4. Press the **Preset +** and **Preset - Buttons** to cycle through the saved presets.

USING THE AUXILIARY INPUT

1. Press the **Source Button** to switch to *Aux Mode*.

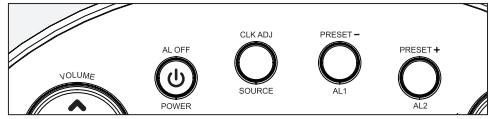

2. Connect an MP3 Player or other audio source to the **Auxiliary Input**.

Connecting an audio source to the Auxiliary Input requires a cord with a 3.5 mm mini-phono plug.

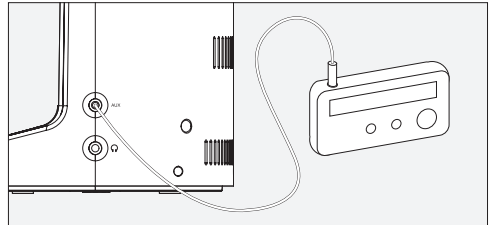

3. Use the connected device's controls to play, pause, stop, and skip between tracks on the connected device.

UNIT CONTROLS & FEATURES

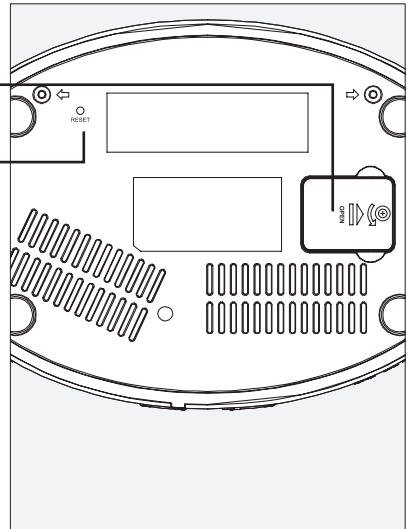
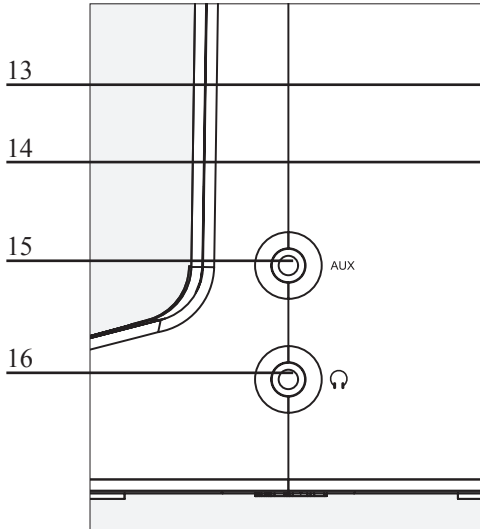
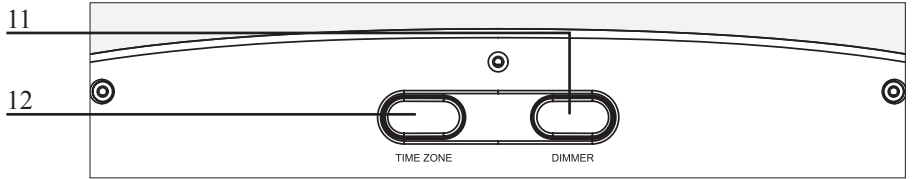
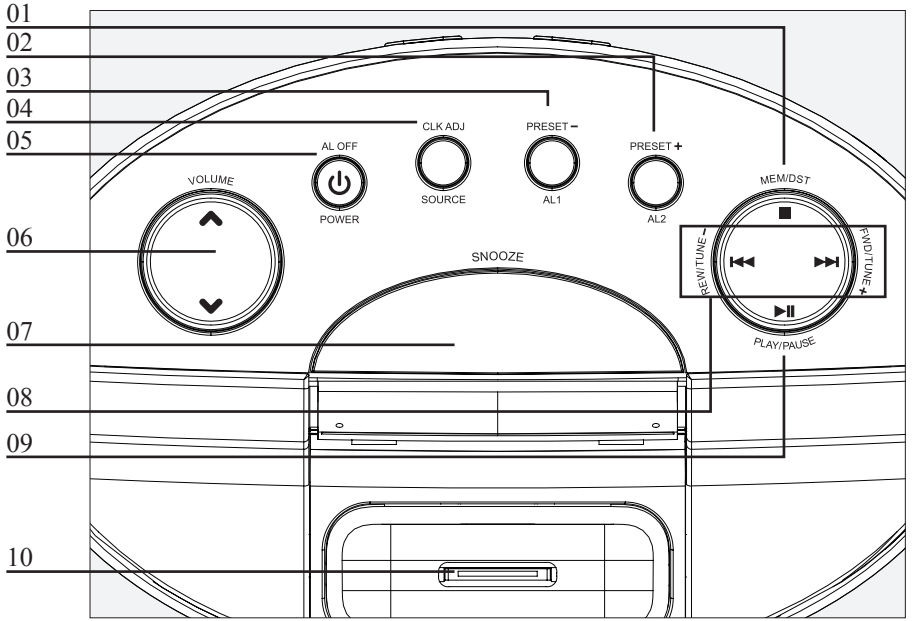

01. Memory/DST Button

Press the Memory Button to save an AM or FM radio station as a preset.

Press the DST Button to activate or deactivate Daylight Savings Time.

02. Preset +/-Alarm 2 Button

Press the Preset + Button to cycle through AM and FM radio presets.

Press and hold the Alarm 2 Button to set alarm 2.

03. Preset -/Alarm 1 Button

Press the Preset - Button to cycle through AM and FM radio presets.

Press and hold the Alarm 1 Button to set alarm 1.

04. Clock Adjust/Source Button

Press and hold the Clock Adjust Button to set the time on the unit.

Press the Source Button to switch between iPod, Aux, AM, FM, and Off modes.

05. Power/Alarm Off Button

Press the Power Button to turn the unit on and off.

Press the Alarm Off Button to turn the alarm off after it sounds.

06. Volume Button

Press the Volume Button to adjust the volume of the unit.

07. Snooze Button

Press the Snooze Button to delay the alarm for an additional 9 minutes after it sounds.

08. Rewind/Tune - Button**Fast Forward/Tune + Button**

Press the Rewind/Tune- Button or Fast Forward/Tune + Button to skip from one track to the next on a docked iPod.

Press and hold the Rewind/Tune- Button or Fast Forward/Tune + Button to search through an individual track on a docked iPod.

Press the Rewind/Tune- Button or Fast Forward/Tune + Button to tune the AM or FM radio.

09. Play/Pause Button

Press the Play/Pause Button to play or pause a docked iPod.

10. Dock for iPod**11. Dimmer Button**

Press the Dimmer Button to adjust the brightness of the LCD display, or to turn the display off.

12. Time Zone Button

Press the Time Zone Button to adjust the Time Zone of the unit.

13. Backup Battery Compartment

Requires 1 CR2025 battery (pre-installed)

14. Reset Button

Press the Reset Button using a paper clip or like object to restore the unit to the manufacturer's default settings.

15. Auxiliary Input

Use the Auxiliary Input to connect an MP3 player or other audio source to the unit.

16. Headphone Jack

Use the Headphone Jack to connect a set of headphones or earbuds to the unit.

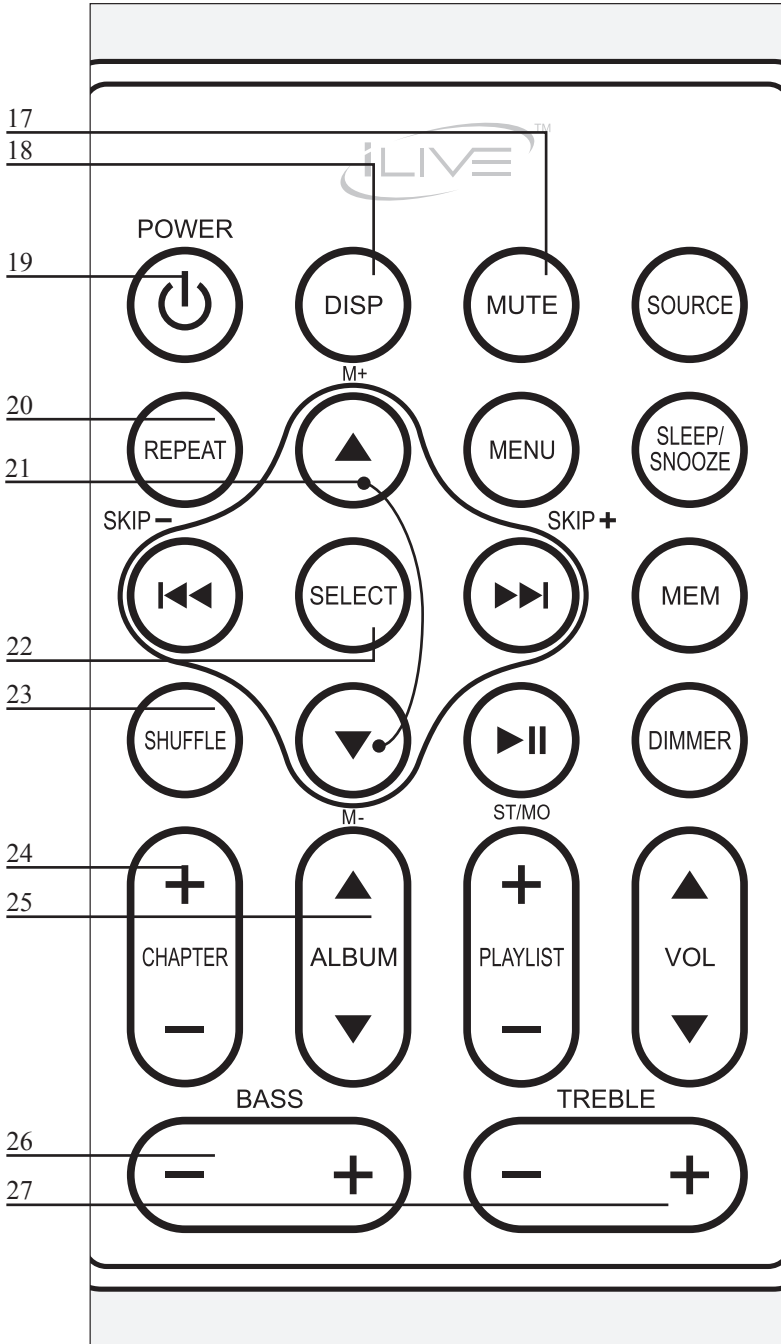

17. Mute Button

Press the Mute Button to mute the unit's volume.

18. Display Button

Press the Display Button to view the set alarm times.

19. Power Button

Press the Power Button to turn the unit off and on.

20. Repeat Button

Press the Repeat Button once to repeat the current track on a docked iPod.

Press the Repeat Button twice to repeat an entire album or playlist on a docked iPod.

21. M+/M- Button

Press the M+/M- Button to cycle through menu items on a docked iPod.

Press the M+/M- Button to cycle through preset AM and FM radio stations.

22. Select Button

Press the Select Button to make selections in the menus of a docked iPod.

23. Shuffle Button

Press the Shuffle Button to activate the shuffle feature on a docked iPod.

24. Chapter Buttons

Press the Chapter Buttons to cycle through chapters on a docked iPod.

25. Album Buttons

Press the Album Buttons to cycle through albums on a docked iPod.

26. Bass Buttons

Press the Bass Buttons to adjust the levels of bass on the unit.

27. Treble Buttons

Press the Treble Buttons to adjust the level of treble on the unit.

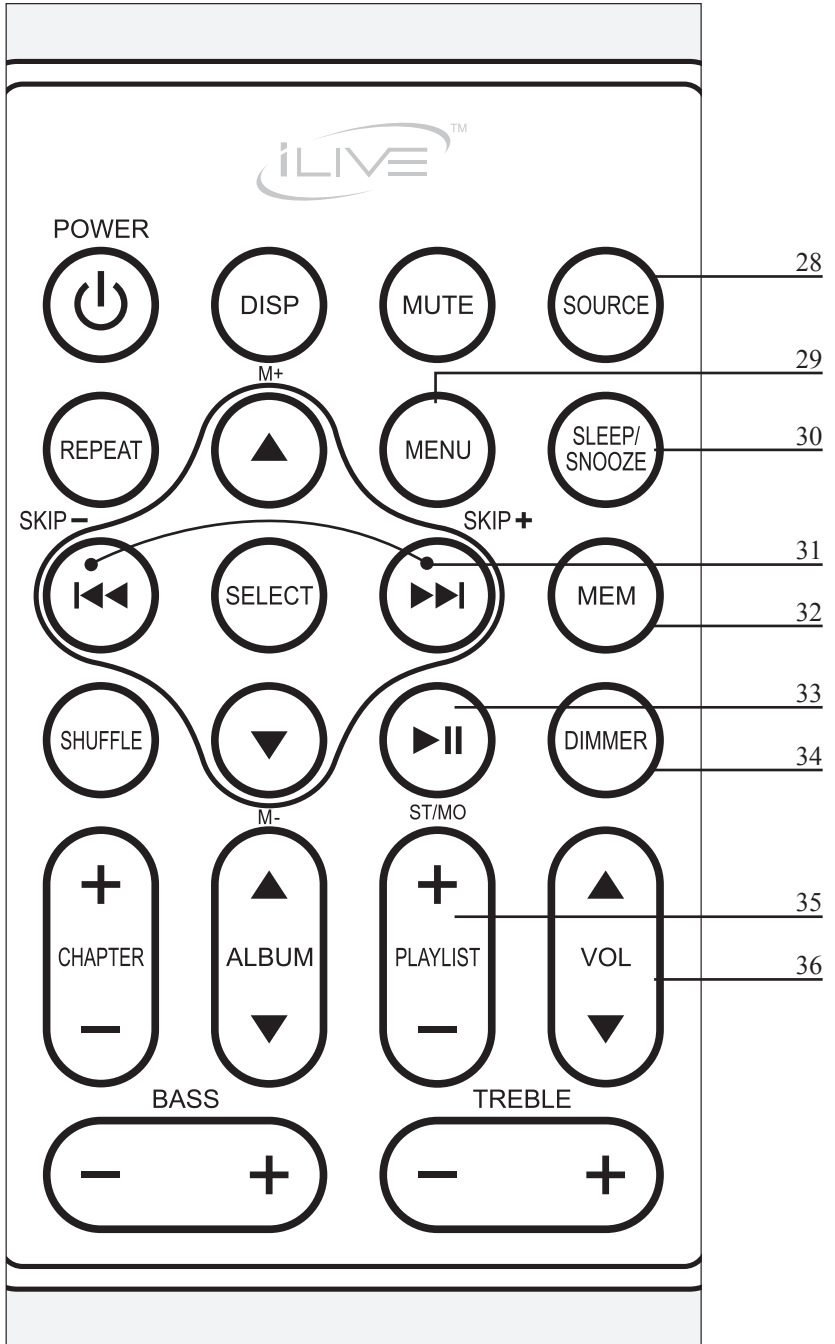

28. Source Button

Press the Source Button to switch between iPod, Aux, AM, and FM modes.

29. Menu Button

Press the Menu Button to move to the previous menu on a docked iPod.

30. Sleep/Snooze Button

Press the Sleep Button consecutively to set the sleep timer between 1 and 90 minutes.

Press the Snooze Button to delay the alarm for an additional 9 minutes after it has sounded.

31. Skip -/Skip+ Button

Press the Skip-/Skip+ Button to skip through tracks on a docked iPod.

Press and hold the Skip-/Skip+ Button to search through an individual track on a docked iPod.

Press the Skip-/Skip+ Button to tune the AM or FM radio.

32. Memory Button

Press the Memory Button save an AM or FM radio station as a preset.

33. Play/Pause Button

Press the Play/Pause Button to play or pause a docked iPod.

34. Dimmer Button

Press the Dimmer Button to adjust the brightness of the LCD display.

35. Playlist Buttons

Press the Playlist Buttons to cycle through playlists on a docked iPod.

36. Volume Buttons

Press the Volume Buttons to adjust the volume of the unit.

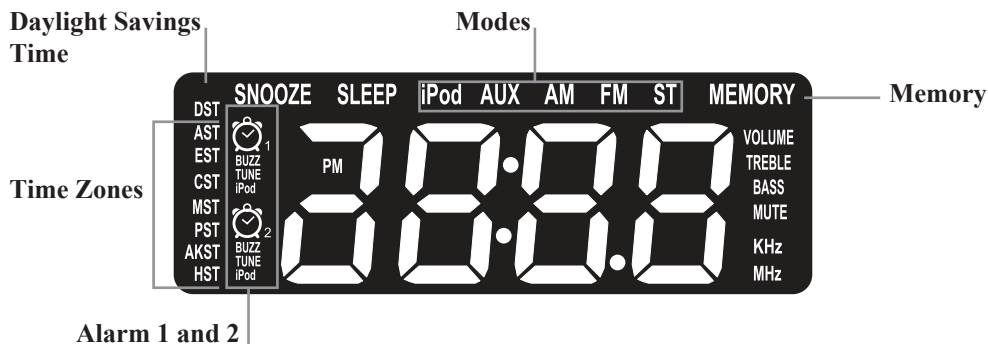

COMPANY INFORMATION

GREEN INITIATIVE

Environmental Commitment to ‘Protect for Today and Sustain for Tomorrow’

2009 marks the official launch of DPI, Inc.’s corporate campaign for a greener and cleaner world. DPI and its four brands, iLive, WeatherX, Capri, and GPX, are building upon environmental initiatives introduced at all of their facilities to help formulate and sustain significant and important conservation efforts within its manufacturing and marketing communities. In addition to targeting and selecting energy efficient product features, and structuring ‘green office’ procedures, other initial program efforts include:

- Reduction of all packaging sizes
- Recyclable plastics for clamshell packages, with a plan to eventually replace plastic with recyclable paper
- Recycled fiber board in place of the polyfoam in packing boxes
- Recycled plastics in place of the virgin material in product construction

INTERNATIONAL SUPPORT

To download this User’s Guide in English, Spanish, or French, visit the support section at www.ilive.net.

Para transferir esta guía de usuario en inglés, español, o francés, visite la sección de la ayuda en www.ilive.net.

Pour télécharger ce guide de l’utilisateur en anglais, espagnol, ou français, visitez la section de soutien chez www.ilive.net.

SERVICE INFORMATION

Address: 2116 Carr Street, St. Louis MO, 63106

Phone: 1-314-621-2881

Fax: 1-314-588-1805

Email: customerservice@ilive.net

Parts Email: partsinfo@dpi-global.com

Website: www.ilive.net