

# SHARP

## MUSIC SYSTEM FOR iPod®

MODEL

# DK-A10 DK-A10BK

### OPERATION MANUAL



iPod is a registered trade marks of Apple Computer, Inc.



## AM/FM ALARM MP3

**Note:**  
This product is not compatible with MTP and AAC file systems.

Thank you for purchasing this SHARP product.  
To obtain the best performance from this product, please read this manual carefully. It will guide you in operating your SHARP product.

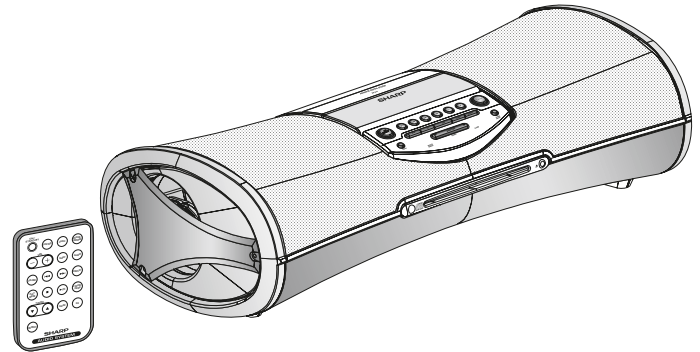

This illustrations printed in this operation manual are for the model DK-A10.

## Accessories

Please confirm that the following accessories are included.

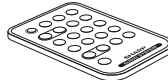
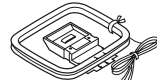
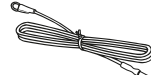
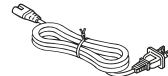
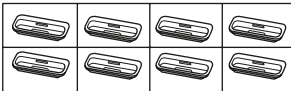
 <p>Remote control × 1 RRMCGA110AWSA (DK-A10) RRMCGA111AWSA (DK-A10BK)</p>	 <p>AM loop antenna × 1 (QANTL0010AWZZ)</p>	 <p>FM antenna × 1 QANTW0004AW09 (DK-A10) 92LFANT1535A (DK-A10BK)</p>
 <p>AC power cord × 1 QACCD0025AW09 (DK-A10) QACCD0025AWZZ (DK-A10BK)</p>	 <p>iPod adaptor × 8 UACRTA008AW01</p>	

**Note:** Only the above accessories are included.

# SPECIAL NOTES



**CAUTION**  
RISK OF ELECTRIC SHOCK  
DO NOT OPEN



**CAUTION: TO REDUCE THE RISK OF ELECTRIC SHOCK, DO NOT REMOVE COVER (OR BACK). NO USER-SERVICEABLE PARTS INSIDE. REFER SERVICING TO QUALIFIED SERVICE PERSONNEL.**

**Explanation of Graphical Symbols:**



The lightning flash with arrowhead symbol, within an equilateral triangle, is intended to alert the user to the presence of uninsulated "dangerous voltage" within the product's enclosure that may be of sufficient magnitude to constitute a risk of electric shock to persons.



The exclamation point within an equilateral triangle is intended to alert the user to the presence of important operating and maintenance (servicing) instructions in the literature accompanying the appliance.

**WARNING: TO REDUCE THE RISK OF FIRE OR ELECTRIC SHOCK, DO NOT EXPOSE THIS APPLIANCE TO RAIN OR MOISTURE.**

**This product is classified as a CLASS 1 LASER PRODUCT "Caution: Use of any controls, adjustments or procedures other than those specified herein may result in hazardous radiation exposure."**

**Note to CATV system installer:**

This reminder is provided to call the CATV system installer's attention to Article 820-40 of the National Electrical Code that provides guidelines for proper grounding and, in particular, specifies that the cable ground shall be connected to the grounding system of the building, as close to the point of cable entry as practical.

**NOTE**

This equipment has been tested and found to comply with the limits for a Class B digital device, pursuant to Part 15 of the FCC Rules. These limits are designed to provide reasonable protection against harmful interference in a residential installation. This equipment generates, uses, and can radiate radio frequency energy and, if not installed and used in accordance with the instructions, may cause harmful interference to radio communications. However, there is no guarantee that interference will not occur in a particular installation. If this equipment does cause harmful interference to radio or television reception, which can be determined by turning the equipment off and on, the user is encouraged to try to correct the interference by one or more of the following measures:

- Reorient or relocate the receiving antenna.
- Increase the separation between the equipment and receiver.
- Connect the equipment into an outlet on a circuit different from that to which the receiver is connected.
- Consult the dealer or an experienced radio/TV technician for help.

**WARNING**

FCC Regulations state that any unauthorized changes or modifications to this equipment not expressly approved by the manufacturer could void the user's authority to operate this equipment.

**Note:**

- Licensed under one or more of U.S. Pat. 4,972,484, 5,214,678, 5,323,396, 5,530,655, 5,539,829, 5,544,247, 5,606,618, 5,610,985, 5,740,317, 5,777,992, 5,878,080 or 5,960,037.

**FOR YOUR RECORDS**

For your assistance in reporting this unit in case of loss or theft, please record below the model number and serial number which are located on the rear of the unit. Please retain this information.

**Model number** .....

**Serial number** .....

**Date of purchase** .....

**Place of purchase** .....

# IMPORTANT SAFETY INSTRUCTIONS

Electricity is used to perform many useful functions, but it can also cause personal injuries and property damage if improperly handled. This product has been engineered and manufactured with the highest priority on safety. However, improper use can result in electric shock and/or fire. In order to prevent potential danger, please observe the following instructions when installing, operating and cleaning the product. To ensure your safety and prolong the service life of this product, please read the following precautions carefully before use.

- 1) Read these instructions.
- 2) Keep these instructions.
- 3) Heed all warnings.
- 4) Follow all instructions.
- 5) Do not use this apparatus near water.
- 6) Clean only with dry cloth.
- 7) Do not block any ventilation openings. Install in accordance with the manufacturer's instructions.
- 8) Do not install near any heat sources such as radiators, heat registers, stoves, or other apparatus (including amplifiers) that produce heat.
- 9) Do not defeat the safety purpose of the polarized or grounding-type plug. A polarized plug has two blades with one wider than the other. A grounding type plug has two blades and a third grounding prong. The wide blade or the third prong are provided for your safety. If the provided plug does not fit into your outlet, consult an electrician for replacement of the obsolete outlet.
- 10) Protect the power cord from being walked on or pinched particularly at plugs, convenience receptacles, and the point where they exit from the apparatus.
- 11) Only use attachments/accessories specified by the manufacturer.
- 12) Use only with the cart, stand, tripod, bracket, or table specified by the manufacturer, or sold with the apparatus. When a cart is used, use caution when moving the cart/apparatus combination to avoid injury from tip-over. 
- 13) Unplug this apparatus during lightning storms or when unused for long periods of time.
- 14) Refer all servicing to qualified service personnel. Servicing is required when the apparatus has been damaged in any way, such as power-supply cord or plug is damaged, liquid has been spilled or objects have fallen into the apparatus, the apparatus has been exposed to rain or moisture, does not operate normally, or has been dropped.

## Additional Safety Information

- 15) Power Sources - This product should be operated only from the type of power source indicated on the marking label. If you are not sure of the type of power supply to your home, consult your product dealer or local power company. For product intended to operate from battery power, or other sources, refer to the operating instructions.
- 16) Overloading - Do not overload wall outlets, extension cords, or integral convenience receptacles as this can result in a risk of fire or electric shock.
- 17) Object and Liquid Entry - Never push objects of any kind into this product through openings as they may touch dangerous voltage points or short-out parts that could result in a fire or electric shock. Never spill liquid of any kind on the product.

# IMPORTANT SAFETY INSTRUCTIONS (continued)

- 18) Damage Requiring Service - Unplug this product from the wall outlet and refer servicing to qualified service personnel under the following conditions :
- When the AC cord or plug is damaged,
  - If liquid has been spilled, or objects have fallen into the product,
  - If the product has been exposed to rain or water,
  - If the product does not operate normally by following the operating instructions. Adjust only those controls that are covered by the operating instructions as an improper adjustment of other controls may result in damage and will often require extensive work by a qualified technician to restore the product to its normal operation,
  - If the product has been dropped or damaged in any way, and
  - When the product exhibits a distinct change in performance - this indicates a need for service.
- 19) Replacement Parts - When replacement parts are required, be sure the service technician has used replacement parts specified by the manufacturer or have the same characteristics as the original part. Unauthorized substitutions may result in fire, electric shock, or other hazards.
- 20) Safety Check - Upon completion of any service or repairs to this product, ask the service technician to perform safety checks to determine that the product is in proper operating condition.
- 21) Wall or ceiling mounting - When mounting the product on a wall or ceiling, be sure to install the product according to the method recommended by the manufacturer.
- 22) Power Lines - An outside antenna system should not be located in the vicinity of overhead power lines or other electric light or power circuits, or where it can fall into such power lines or circuits. When installing an outside antenna system, extreme care should be taken to keep from touching such power lines or circuits as contact with them might be fatal.

- 23) Outdoor Antenna Grounding - If an outside antenna or cable system is connected to the product, be sure the antenna or cable system is grounded so as to provide some protection against voltage surges and built-up static charges. Article 810 of the National Electrical Code, ANSI/NFPA 70, provides information with regards to proper grounding of the mast and supporting structure, grounding of the lead-in wire to an antenna discharge unit, connection to grounding electrodes, and requirements for the grounding electrode.

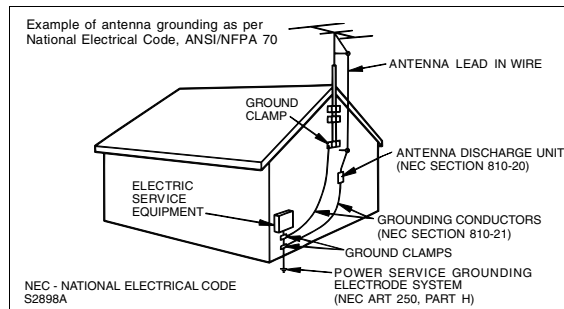

- 24) Protective Attachment Plug - The product is equipped with an attachment plug having overload protection. This is a safety feature. See Instruction Manual for replacement or resetting of protective device. If replacement of the plug is required, be sure the service technician has used a replacement plug specified by the manufacturer that has the same overload protection as the original plug.
- 25) Stand - Do not place the product on an unstable cart, stand, tripod or table. Placing the product on an unstable base can cause the product to fall, resulting in serious personal injuries as well as damage to the product. Use only a cart, stand, tripod, bracket or table recommended by the manufacturer or sold with the product. When mounting the product on a wall, be sure to follow the manufacturer's instructions. Use only the mounting hardware recommended by the manufacturer.

## ENERGY STAR® Program Information



Products that have earned the ENERGY STAR® are designed to protect the environment through superior energy efficiency.

To comply with the ENERGY STAR® standards mentioned above, please cancel the demonstration mode, as described on page 10.

**ENERGY STAR® is a U.S. registered mark.**

## Special Note

Supply of this product does not convey a license nor imply any right to distribute content created with this product in revenue-generating broadcast systems (terrestrial, satellite, cable and/or other distribution channels), revenue-generating streaming applications (via Internet, intranets and/or other networks), other revenue-generating content distribution systems (pay-audio or audio-on-demand applications and the like) or on revenue-generating physical media (compact discs, digital versatile discs, semiconductor chips, hard drives, memory cards and the like). An independent license for such use is required. For details, please visit <http://mp3licensing.com>  
MPEG Layer-3 audio coding technology licensed from Fraunhofer IIS and Thomson.

## Contents

	Page
■ <b>General Information</b>	
Precautions .....	6
Controls and indicators .....	7 - 9
■ <b>Preparation for Use</b>	
System connections .....	10
Remote control .....	11
■ <b>Basic Operation</b>	
General control .....	12
Setting the clock .....	13
■ <b>iPod</b>	
Listening to the iPod .....	14 - 16
■ <b>CD or MP3/WMA disc Playback</b>	
Listening to a CD or MP3/WMA disc .....	17 - 18
Advanced CD or MP3/WMA disc playback .....	19 - 20
MP3/WMA folder mode (only for MP3/WMA files) .....	21 - 22
■ <b>Radio</b>	
Listening to the radio .....	23 - 24
■ <b>Advanced Features</b>	
Alarm and sleep operation .....	25 - 26
Enhancing your system .....	27
■ <b>References</b>	
Troubleshooting chart .....	28 - 29
Maintenance .....	29
Specifications .....	29
CONSUMER LIMITED WARRANTY .....	Back cover

# Precautions

## ■ General

- Use the unit on a firm, level surface free from vibration.

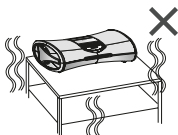

- Keep the unit away from direct sunlight, strong magnetic fields, excessive dust, humidity and electronic/electrical equipment (home computers, facsimiles, etc.) which generate electrical noise.

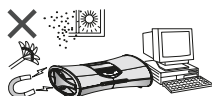

- Do not place anything on top of the unit.
- Do not expose the unit to moisture, to temperatures higher than 140°F (60°C) or to extremely low temperatures.
- If your system does not work properly, disconnect the AC power cord from the AC outlet. Plug the AC power cord back in, and then turn on your system.
- In case of an electrical storm, unplug the unit for safety.

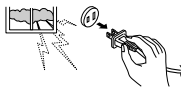

- Hold the AC power plug by the head when removing it from the AC outlet, as pulling the cord can damage internal wires.
- The AC power plug is used as disconnect device and shall always remain readily operable.

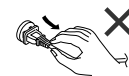

- **Do not remove the outer cover, as this may result in electric shock. Refer internal service to your local SHARP service facility.**

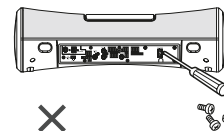

- This unit should only be used within the range of 41°F - 95°F (5°C - 35°C).

## Warning:

The voltage used must be the same as that specified on this unit. Using this product with a higher voltage other than that which is specified is dangerous and may result in a fire or other type of accident causing damage. SHARP will not be held responsible for any damage resulting from use of this unit with a voltage other than that which is specified.

## ■ Volume control

The sound level at a given volume setting depends on speaker efficiency, location and various other factors. It is advisable to avoid exposure to high volume levels, which occurs while turning the unit on with the volume control setting up high, or while continually listening at high volumes.

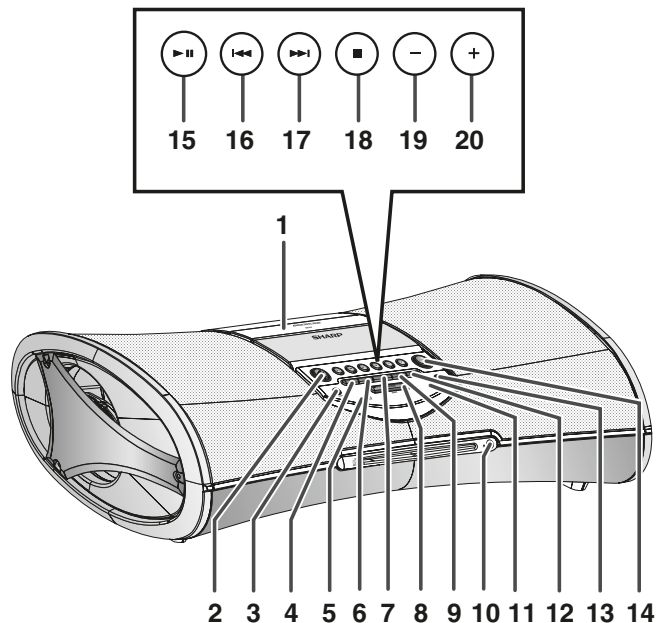

## ■ Top panel

	Reference page
1. iPod Terminal .....	15
2. POWER ON/STAND-BY Button .....	11, 12, 23
3. Clock Button .....	13
4. iPod Button .....	14
5. Remote Sensor .....	11
6. CD Button .....	17
7. Auxiliary Button .....	27
8. Snooze/Dimmer Button .....	12, 25
9. Tuner Button .....	23
10. CD Eject Button .....	18
11. Alarm Indicator .....	25
12. Alarm Button .....	25
13. Alarm ON/OFF Button .....	25
14. E Sound Button .....	10, 12
15. Play/Pause Button .....	16, 18
16. Skip Down, Tuner Preset Down Button .....	13, 16, 18, 24
17. Skip Up, Tuner Preset Up Button .....	13, 16, 18, 24
18. Stop Button .....	12
19. Volume Down Button .....	12
20. Volume Up Button .....	12

## Controls and indicators (continued)

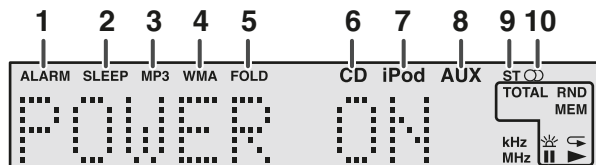

The model name/serial no. label (\*)

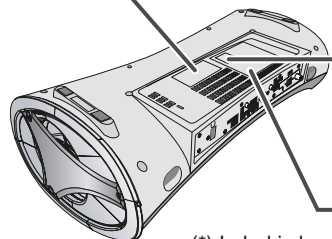

The iPod rating label (\*)

The spec label (\*)

(\*) Label is located at the bottom of the unit.

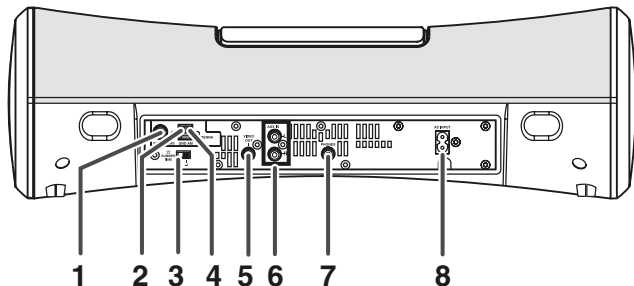
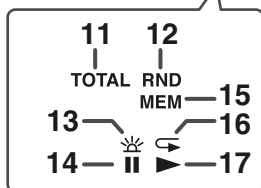

### ■ Display

	Reference page
1. Alarm Indicator .....	25
2. Sleep Indicator .....	26
3. MP3 Indicator .....	18
4. WMA Indicator .....	18
5. FOLD Indicator .....	22
6. CD Indicator .....	18
7. iPod Indicator .....	14
8. Aux Indicator .....	27
9. FM Stereo Mode Indicator .....	23
10. FM Stereo Receiving Indicator .....	23
11. Total Indicator .....	18, 22
12. Random Indicator .....	19
13. Summer Indicator .....	13
14. Pause Indicator .....	16, 18
15. Memory Indicator .....	20
16. Repeat Play Indicator .....	19
17. Play Indicator .....	18

### ■ Rear panel

	Reference page
1. FM 75 Ohms Antenna Jack .....	10
2. AM Antenna Ground Terminal .....	10
3. Summer Time Switch .....	13
4. AM Loop Antenna Terminal .....	10
5. Video Out Jack .....	27
6. Auxiliary Input Jacks .....	27
7. Headphone Jack .....	27
8. AC Input Jack .....	10



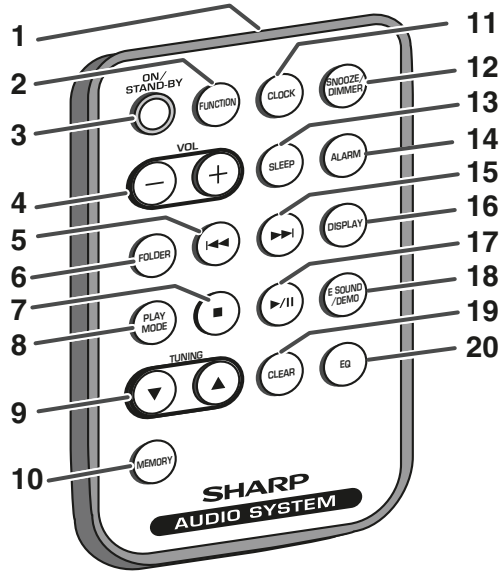

## ■ Remote control

	Reference page
1. Remote Control Transmitter .....	11
2. Function Button .....	16
3. On/Stand-by Button .....	11, 12, 23
4. Volume Up and Down Buttons .....	12
5. Skip Down, Tuner Preset Down Button .....	13, 16, 18, 24
6. Folder Button .....	21
7. Stop Button .....	18
8. Play Mode Button .....	16, 19
9. Tuning Up and Down Buttons .....	23
10. Memory Button .....	20, 24
11. Clock Button .....	13
12. Snooze/Dimmer Button .....	12, 25
13. Sleep Button .....	26
14. Alarm Button .....	25
15. Skip Up, Tuner Preset Up Button .....	13, 16, 18, 24
16. Display Button .....	16
17. Play/Pause Button .....	16, 18, 19
18. E Sound/Demo Button .....	10, 12
19. Clear Button .....	20
20. EQ Button .....	12

### Note:

Before using remote control, please remove plastic shield at battery holder.

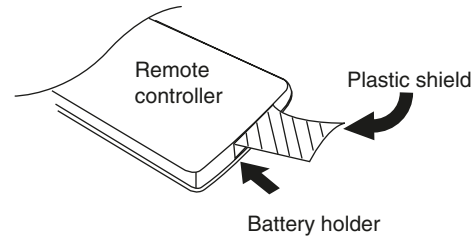

# System connections

**Make sure to unplug the AC power cord before any connections.**

## ■ Antenna connection

### Supplied FM antenna:

Connect the FM antenna wire to the FM 75 OHMS jack and position the FM antenna wire in the direction where the strongest signal can be received.

### Supplied AM loop antenna:

Connect the AM loop antenna to the AM and GND terminals. Position the AM loop antenna for optimum reception. Place the AM loop antenna on a shelf, etc., or attach it to a stand or a wall with screws (not supplied).

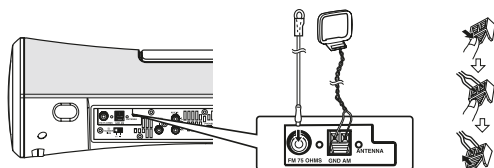

### Note:

Placing the antenna on the unit or near the AC power cord may cause noise pickup. Place the antenna away from the unit for better reception.

### Installing the AM loop antenna:

< Assembling >

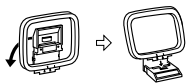

< Attaching to the wall >



## ■ Outdoor FM antenna

Use an outdoor FM antenna if you require better reception. Consult your dealer.

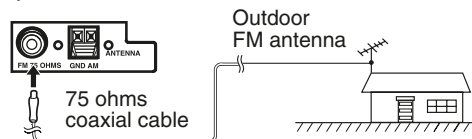

### Note:

When an outdoor FM antenna is used, disconnect the supplied FM antenna wire.

## ■ iPod connecting to TV

iPod photo and 5th Generation iPod with photo and video can be view by connecting to TV/monitor.

If the TV/monitor has a video input, connect it to the VIDEO OUT jack on the rear of the unit.

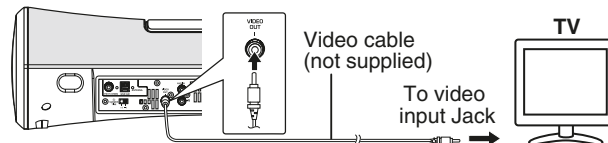

## ■ AC power connection

After checking all the connections have been made correctly, plug the AC power cord of this unit into the AC outlet. If you plug in the unit first, the unit will enter the demonstration mode.

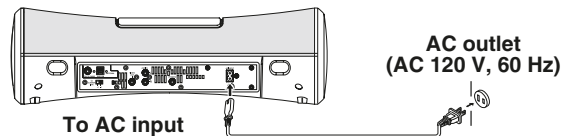

### Note:

● Unplug the AC power cord from the AC outlet if the unit will not be in use for a prolonged period of time.

## ■ Demonstration mode

The first time the unit is plugged in, the unit will enter the low power consumption mode.

### To activate the demonstration mode:

When the unit is in the power stand-by mode (low power consumption mode), press the E SOUND/DEMO button. The unit will enter the demonstration mode.

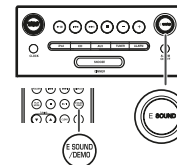

### To return to the low power consumption mode:

When the unit is in the power stand-by mode, press the E SOUND/DEMO button again. The iPod terminal door will automatically close if iPod unit is not inserted.

### Note:

When the power is on, the E SOUND/DEMO button can be used to select the E SOUND mode.

# Remote control

## ■ Battery installation

This product contains a CR Coin Lithium Battery which contains Perchlorate Material – special handling may apply, California residents, see [www.dtsc.ca.gov/hazardouswaste/perchlorate/](http://www.dtsc.ca.gov/hazardouswaste/perchlorate/)

- 1 While pushing the locking tab toward the center of the remote control, slide out the battery holder.

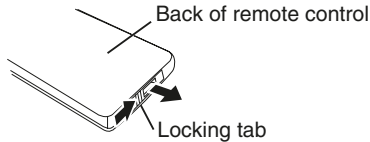

- 2 Remove the old battery from the battery holder, insert the new battery and then slide the battery holder back into the remote control.

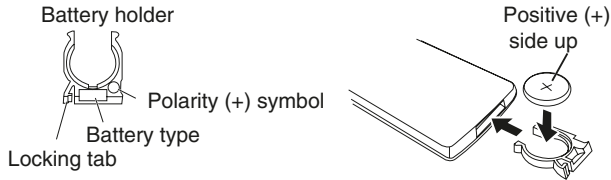

### Precautions for battery use:

- Remove the battery if the unit will not be used for long periods of time. This will prevent potential damage due to battery leakage.

### Caution:

- Do not use rechargeable battery (nickel-cadmium battery, etc.).
- Installing the battery incorrectly may cause the unit to malfunction.

### Notes concerning use:

- Replace the battery if the operating distance is reduced or if the operation becomes erratic. Purchase “CR 2025”, coin lithium battery.
- Periodically clean the transmitter on the remote control and the sensor on the unit with a soft cloth.
- Exposing the sensor on the unit to strong light may interfere with operation. Change the lighting or the direction of the unit if this occurs.
- Keep the remote control away from moisture, heat, shock, and vibrations.

### ■ Test of the remote control

Check the remote control after checking all the connections (see page 10).

Point the remote control directly at the remote sensor on the unit.

### The remote control can be used within the range shown below:

Press the ON/STAND-BY button. Does the power turn on? Now, you can enjoy music.

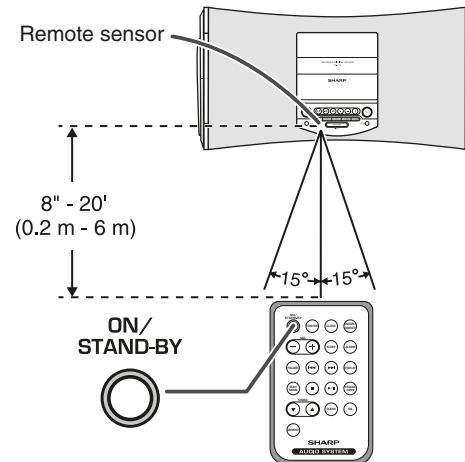

# General control

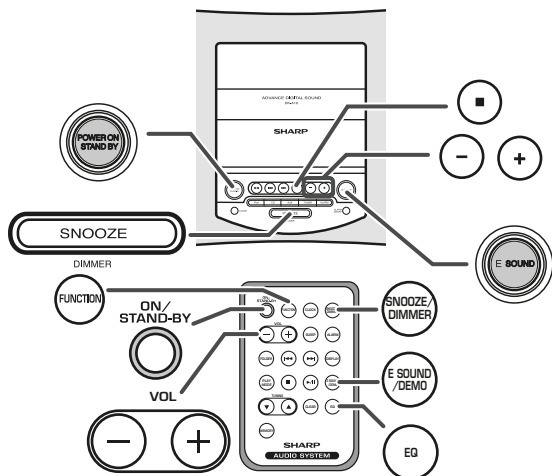

## ■ To turn the power on

Press the ON/STAND-BY button to turn the power on.

### After use:

Press the ON/STAND-BY button to enter the power stand-by mode.

## ■ Illumination light control

Press the SNOOZE/DIMMER button to adjust the brightness of the display and LED.

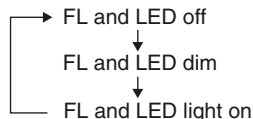

## ■ Volume auto fade-in

If you turn off and on the main unit with the volume set to 27 or higher, the volume starts at 16 and fades in to the last set level.

## ■ Volume control

### Main unit and remote control operation:

Press the VOL (+ or -) button to increase or decrease the volume.



## ■ E SOUND control

When the E SOUND/DEMO button is pressed, the unit will enter the E Sound mode and adjust low bass and high frequency automatically according to volume input. To change the setting, press the E SOUND/DEMO button repeatedly to toggle ON or OFF.



## ■ Equalizer

When the EQ button is pressed, the current mode setting will be displayed. To change to a different mode, press the EQ button repeatedly until the desired sound mode appears.

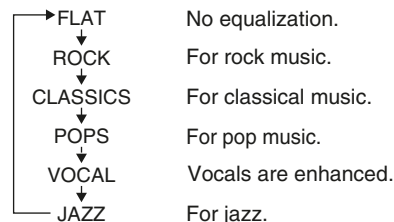

## ■ Function

When the FUNCTION button on remote control is pressed, the current function will change to different mode, press the FUNCTION button repeatedly to select desired function.



### Note:

The backup function protect the memorized function mode for a few days should there be a power failure or the AC power cord becomes disconnected.

# Setting the clock

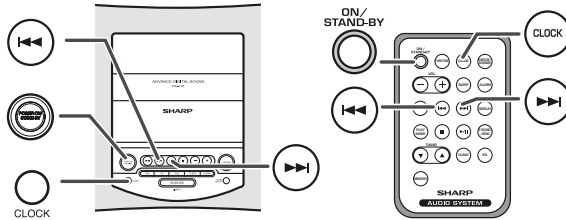

In this example, the clock is set for the 12-hour (12:00 AM) display.

- 1 Press the CLOCK button for more than 2 seconds.**
- 2 Press the ◀◀ or ▶▶ button to select 12-hour or 24-hour display and then press the CLOCK button.**

“AM 12:00” → The 12-hour display will appear.  
(AM 12:00 - PM 11:59)

“AM 0:00” → The 12-hour display will appear.  
(AM 0:00 - PM 11:59)

“0:00” → The 24-hour display will appear.  
(0:00 - 23:59)

- 3 Press the ◀◀ or ▶▶ button to adjust the hour and then press the CLOCK button.**

Press the ◀◀ or ▶▶ button once to advance the time by 1 hour. Hold it down to advance continuously.

- 4 Press the ◀◀ or ▶▶ button to adjust the minutes and then press the CLOCK button.**

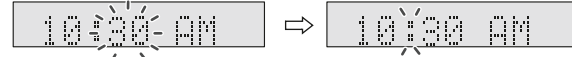

Press the ◀◀ or ▶▶ button once to advance the time by 1 minute. Hold it down to change the time in 5-minute interval. You can press the CLEAR button to abort clock setting.

**To confirm the time display:**  
[When the unit is in the stand-by mode]  
Press the CLOCK button to enter the clock function.

[When the power is on]  
Press DISPLAY button on remote control to toggle between the function information and clock display.

**Notes:**

- The clock will continue counting for 8 hours should there be a power failure or the AC power cord becomes disconnected.
- The “CLOCK ADJ” will appear or time will flash to confirm the time display when the AC power supply is restored after a power failure or unplugging the unit after 8 hours. If incorrect, readjust the clock as follows.

**To readjust the clock:**  
Perform “Setting the clock” from step 1. Step 2 (selecting the 12-hour or 24-hour display) will be skipped.

**To change the 12-hour or 24-hour display:**

- 1 Clear all the programmed contents. [Refer to “Clearing all the memory (reset)” on page 29 for details.]
- 2 Perform “Setting the clock” from step 1.

**Summer time:**

The ST switch is located on the rear of the unit.

- 1 Slide the ST switch to +1 to advance the time 1 hour. ☀ indicator will appear.
- 2 Slide the ST switch to -1 to turn the clock back 1 hour.



# Listening to the iPod

## Supported iPod:

- iPod nano (software 1.0 above)
- iPod photo (software 1.0 above)
- iPod mini (software 1.2 above)
- 5th Generation iPod (software 1.0 above) (Dock connector equipped Click Wheel model)
- 4th Generation iPod (software 3.0.2 above) (Dock connector equipped Click Wheel model)
- 3rd Generation iPod (software 2.2 above) (Dock connector equipped Click Wheel model)

## Notes:

- Once the iPod is connected to the unit it will begin charging.
- The iPod unit cannot be charged while the main unit is in the stand-by mode.

## Auto power on function:

When you press any of the following buttons, the unit turns on.

- iPod button (main unit): The unit turns on and the "iPod" function is activated.
- ► / || button (main unit and remote control): The unit turns on and playback of the last function will start (iPod, CD, TUNER, AUX).

## ■ iPod adaptor connection

Choose the iPod adaptor that fits your iPod. Your iPod will fit snugly into the correct adaptor. If your iPod is not mentioned below, an iPod adaptor may have been included with your iPod unit.

The number (3-10) shows which iPod fits



iPod Adapter No.	iPod Description	Capacity
3	iPod mini	4GB & 6GB
4	4G iPod & U2 iPod	20GB
5	4G iPod	40GB
6	iPod photo & Color U2 iPod	20GB & 30GB
7	iPod photo	40GB & 60GB
6	iPod with color display	20GB
7	iPod with color display	60GB
8	iPod nano	2GB & 4GB
9	iPod (10/12/05 w/video)	30GB
10	iPod (10/12/05 w/video)	60GB

## Note:

If you have an iPod that does not have an iPod connector, you can use an audio cable to connect it to the AUX IN jacks.

Push the iPod sliding door.

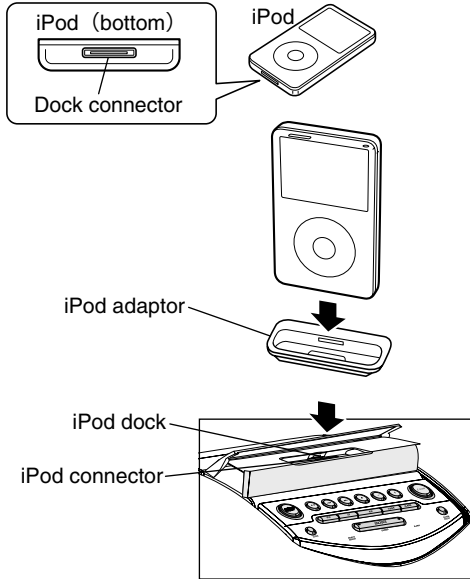
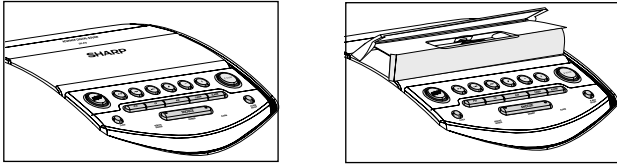

## ■ To remove iPod adaptor

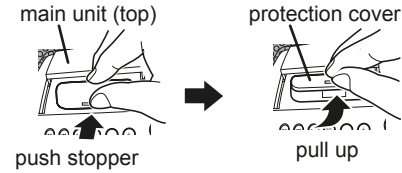

## ■ iPod playback



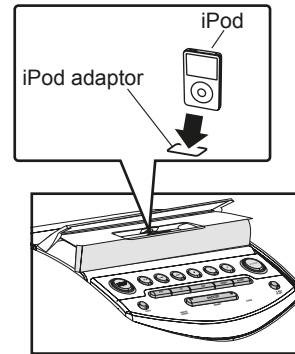







- 1 Press the ON/STAND-BY button to turn the power on. The iPod terminal door will automatically open when the display is on.
- 2 Press the iPod button.
- 3 Insert iPod unit in iPod slot of main unit.



- 4 Press the ► / || button to start playback.

## Listening to the iPod (continued)

### ■ Various iPod functions

Function	Main unit	Remote control	Operation
Play			Press in the pause mode.
Pause			Press in the playback mode.
Track up/down			Press in the playback or pause mode. If you press the button in the pause mode, press the ► /    button to start the desired track.
Fast forward/reverse			Press and hold down in the playback mode. Release the button to resume playback.
Display	—		Press in the playback mode to toggle iPod unit display.
Repeat	—		Press to toggle repeat mode.
Random	—		Press and hold down to toggle random mode.

### iPod operation

Below operation can be done depend on iPod generation.

#### System on operation

When main unit turn to power on (including alarm function), iPod unit will automatically turn to power on.

\* Invalid for iPod 3rd Generation.

#### System off (standby) operation

When main unit turn to standby mode (including alarm and sleep function), iPod unit will automatically turn to standby mode.

#### iPod playback detection function

When iPod unit start playback (including iPod alarm function), below operation will occur:

- During other function is selected, automatically change to iPod function.

#### Caution:

- During playback (including iPod alarm function) operation on iPod unit, sound from main unit will be late for 5 seconds maximum. It is recommended to use alarm function on main unit.
- Unplug all iPod accessory before you insert to iPod slot. iPod playback may become malfunction.

#### Hint:

When iPod unit is inserted, iPod unit will automatically go to power off if there is no operation for 8 seconds.

\* Invalid for iPod 3rd Generation.



## Listening to a CD or MP3/WMA disc

This system can play back a standard CD, CD-R/RW in the CD format and CD-R/RW with MP3 or WMA files, but cannot record on them. Some audio CD-R and CD-RW discs may not be playable due to the state of the disc or the device that was used for recording.

### MP3:

**MP3 is a form of compression. It is an acronym which stands for MPEG Audio Layer 3.**

**MP3 is a type of audio code which is processed by significant compression from the original audio source with very little loss in sound quality.**

- This system supports MPEG 1 Layer 3, MPEG 2 Layer 3, and VBR files.
- During VBR file playback, time counter in the display may differ from its actual playback time.
- Bitrate which is supported by MP3 is 32 ~ 320 kbps.

### WMA:

**WMA files are Advanced System Format files that include audio files which are compressed with Windows Media Audio codec. WMA is developed by Microsoft as an audio format file for Windows Media Player.**

- “MP3” and “WMA” indicator will light up after the unit reads information on an MP3 or WMA disc.
- Bitrate which is supported by WMA is 64 ~ 160 kbps.

### Auto power on function:

When you press any of the following buttons, the unit turns on.

- CD button (main unit): The unit turns on and the “CD” function is activated.
- ► / || button (main unit and remote control): The unit turns on and playback of the last function starts (iPod, CD, TUNER, AUX).

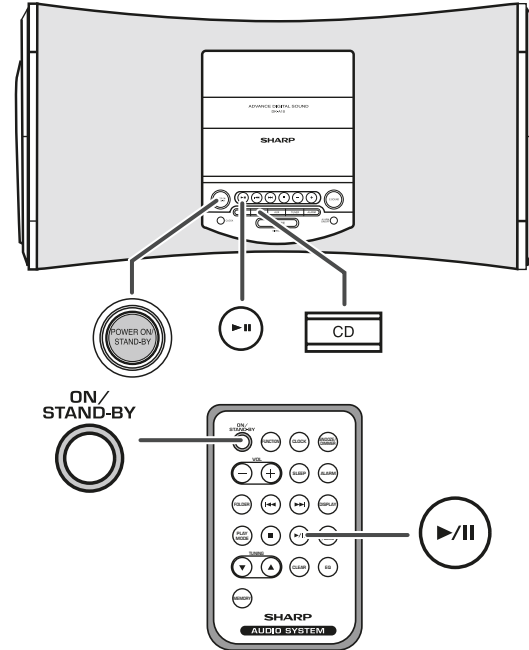

# Listening to a CD or MP3/WMA disc (continued)

**1** Press the ON/STAND-BY button to turn the power on.

**2** Press the CD button.

**3** Insert the disc into the disc, label side up.

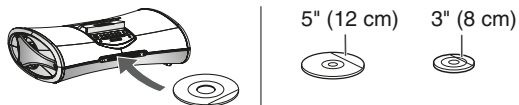

**4** Press the  $\blacktriangle$  OPEN/CLOSE button to close the disc tray 1.



Total number of tracks on the disc      Total playing time of the disc      Total number of files

- Due to the structure of the disc information, it takes longer to read an MP3/WMA disc than a normal CD (approximately 20 to 90 seconds).

**5** Press the  $\blacktriangleright$  /  $\parallel$  button to start playback.



- Playback will begin from track 1.
- After the last track on the disc is played, the unit will stop automatically.

### To remove the discs:

In the stop mode, press the EJECT button.

### Caution:

- Do not play discs of special shapes (heart, octagon, etc). It may cause malfunctions.
- Do not push the disc while it is moving.
- If the power fails while the disc is moving, wait until the power is restored.
- If TV or radio interference occurs during CD operation, move the unit away from the TV or radio.

## ■ Various disc functions

Function	Main unit	Remote control	Operation
<b>Play</b> 			Press in the stop mode.
<b>Stop</b> 			Press in the playback mode.
<b>Pause</b> 			Press in the playback mode. Press the $\blacktriangleright$ / $\parallel$ button to resume playback from the paused point.
<b>Track up/ Track down</b>			Press in the playback or stop mode.  If you press the button in the stop mode, press the $\blacktriangleright$ / $\parallel$ button to start the desired track.
<b>Fast forward/ Fast reverse</b>			Press and hold down in the playback mode.  Release the button to resume playback.

### Notes for CD or MP3/WMA disc:

- When the end of the last track is reached during fast forward, "END" will appear on the display and CD operation will be paused. When the beginning of the first track is reached during fast reverse, the unit will enter the playback mode.
- Rewritable multi session discs which writing is not finished, can still be played.

# Advanced CD or MP3/WMA disc playback

## ■ Repeat play

Repeat play can play all tracks on a disc or a programmed sequence continuously.

### To repeat play:

Press the PLAY MODE button on the remote control.

Press the ► || / ► || button.



### To cancel repeat play:

Press the PLAY MODE button again.  
“G” will disappear.

## ■ Random play

The tracks on the disc can be played in random order automatically.

### To random play:

Press and hold down the PLAY MODE button on the remote control.

Press ► / || button.

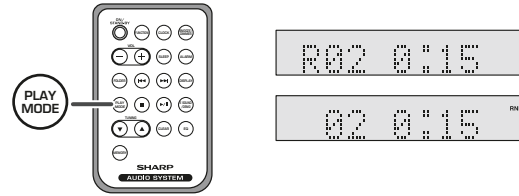

### To cancel random play:

Press and hold down the PLAY MODE button.  
“RND” will disappear.

### Notes:

- If you press the ►► button during random play, you can move to the track selected next by the random operation. On the other hand, the ◀◀ button does not allow you to move to the previous track. The beginning of the track being played will be located.
- In random play, the CD player will select and play tracks automatically. (You cannot select the order of the tracks.)





### Caution:

After performing repeat play, be sure to press the ■ button. Otherwise, the disc will play continuously.

## Advanced CD or MP3/WMA disc playback (continued)

### ■ Programmed play

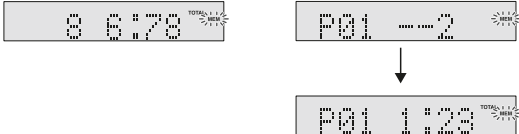
You can choose up to 32 selections for playback in the order you like.

<p><b>1</b> While in the stop mode, press the <b>MEMORY</b> button to enter the programming save mode.</p>	
	
<p><b>2</b> Press the <b>◀◀</b> or <b>▶▶</b> button to select the desired track.</p>	 <p>Selected track number</p>
<p><b>3</b> Press the <b>MEMORY</b> button to save the track number.</p>	
<p><b>4</b> Repeat steps 2 - 4 for other tracks. Up to 32 tracks can be programmed. If you make a mistake, the programmed tracks can be cleared by pressing the <b>CLEAR</b> button.</p>	
<p><b>5</b> Press the <b>■</b> button. The total number in memory will appear.</p>	
<p><b>6</b> Press the <b>▶ /   </b> button to start playback.</p>	

### To clear the programmed selections:

Press the **CLEAR** button on the remote control while the “MEM” indicator is flashing. Each time the button is pressed, one track will be cleared, beginning with the last track programmed.

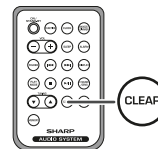

### To cancel the programmed play mode:

While in the stop mode and the “MEM” indicator is lit, press the **CLEAR** button on the remote control. The “MEM” indicator will disappear and all the programmed contents will be cleared.

### Adding tracks to the program:

If a program has been previously stored, the “MEM” indicator will be displayed. Then follow steps 1 - 6 to add tracks. The new tracks will be stored after the last track of the original program.

### To check which tracks are programmed:

While the unit is stopped in the programmed play mode, press the **◀◀** or **▶▶** button.

### Notes:

- When a disc with programmed tracks is ejected, the program is automatically canceled.
- Even if you press the **ON/STAND-BY** button to enter the stand-by mode or change the function from **CD** to another, the programmed selections will not be cleared.
- During the program operation, random play is not possible.

# MP3/WMA folder mode (only for MP3/WMA files)

## To playback MP3/WMA (Windows Media Audio) file

There are many music sites on the internet that you can download MP3/WMA (Windows Media Audio) music files. Follow the instructions from the website on how to download the music files. You can then playback these downloaded music files by burning them to a CD-R/RW disc.

- Your downloaded song/files are for personal use only. Any other usage of the song without owner's permission, is against the law.

## About folder playback order

If MP3/WMA files are recorded in several folders, a folder number will be set to each folder automatically.

These folders can be selected by the FOLDER button on the remote control. If there is no supported file formats inside the selected folder, the folder is skipped and the next folder will be selected.

Example: How to set folder number if MP3/WMA format files are recorded as below figure.

1. ROOT folder is set as folder 1.
2. As for folders inside ROOT folder (Folder A and Folder B), the folder which is recorded earlier on the disc will be set as folder 2.
3. As for folder inside Folder A (Folder C and Folder D), the folder which is recorded earlier on the disc will be set as folder 3.
4. Because there is no folder in Folder C, Folder D will be set as folder 4.
5. Folder E that is inside Folder D will be set as folder 5.
6. Folder B inside ROOT folder will be set as folder 6.

\* The folder and file order information which is recorded on the disc depends on the writing software. There maybe possibilities that this unit will playback the files not according to our expected playback order.

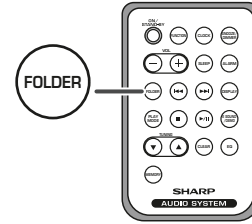

Folder mode on/off can be operated by the FOLDER button on the remote control. Files that are played when folder mode is set to the on position, may differ from those played back when folder mode is turned off.

### Folder Mode Off case:

All the files starting from the selected folder or file will be played back. If file 3 inside Folder C is selected, all the files starting from file 3 will be played back.

### Folder Mode On case:

All the files inside the selected folder will be played back. In case Folder D is selected, file 4, 5 and 6 will be played back. File 7 and 8 in Folder E will not be played back.

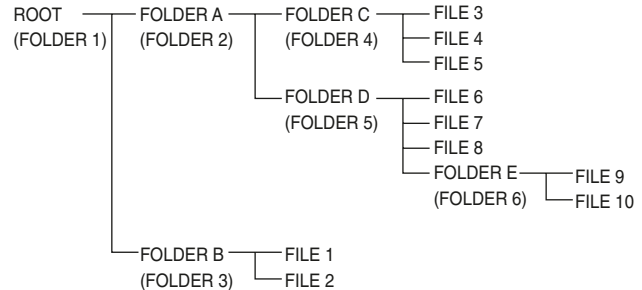

# MP3/WMA folder mode (only for MP3/WMA files) (continued)

## ■ Procedure to playback MP3/WMA disc

To playback CD-R/RW.

### 1 Press the CD button, and load a MP3/WMA disc.

- After disc is loaded, disc info will be displayed.

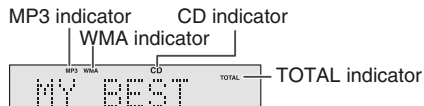

- In case folder is selected, proceed to step 2.
- In case file is selected, proceed to step 4.

### 2 Press the FOLDER button, and press the TUNING (∨ or ∧) button to select desired playback folder. (Folder mode on)

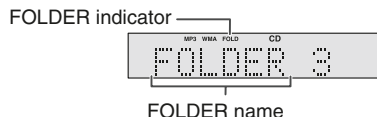

- To start playback with folder mode on, go to step 5.
- To change the playback folder, press the TUNING (∨ or ∧) to select another folder.

### 3 Select desired file to be played back by pressing the ◀◀ or ▶▶ button. Proceed to step 5.



### 4 Select desired file to be played back by pressing the ◀◀ or ▶▶ button. (Folder mode off)



### 5 Press the ▶ / || button. Playback will start and file name will be displayed.

- Title, Artist & Album name is displayed if it is recorded on the disc.
- Display content can be changed by pressing the DISPLAY button.

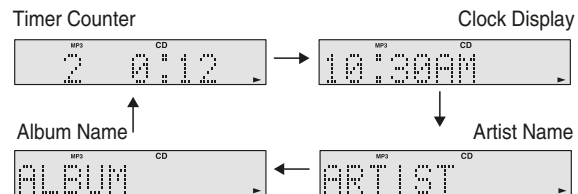

In case of playback with the folder mode on, press the TUNING (∨ or ∧) button, and the folder can be selected even though it is in playback/pause mode.

It will continue playback/pause mode in the 1st track of the selected folder.

(※ 1) MP3 ID3-Tag only support version 1.x.

#### Note:

- If “NO SUPPORT” is displayed, it means “Copyright protected WMA file” or “Not supported playback file” is selected.

# Listening to the radio

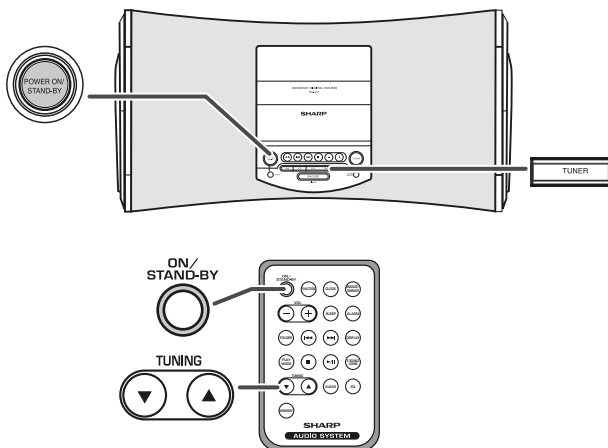

## Auto power on function:

When you press any of the following buttons, the unit turns on.

- TUNER button (main unit): The unit turns on and the TUNER function is activated.
- ► / || button (main unit and remote control): The unit turns on and playback of the last function starts (iPod, CD, TUNER, AUX).

## ■ Tuning

- 1 Press the ON/STAND-BY button to turn the power on.
- 2 Press the TUNER button on main unit or FUNCTION button on remote control repeatedly to select the desired frequency band (FM or AM).
- 3 Press the TUNING (▼ or ▲) button on the remote control to tune in to the desired station.

### Manual tuning:

Press the TUNING (▼ or ▲) button as many times as required to tune in to the desired station.

### Auto tuning:

When the TUNING (▼ or ▲) button is pressed for more than 0.5 seconds, scanning will start automatically and the tuner will stop at the first receivable broadcast station.

### Notes:

- When radio interference occurs, auto scan tuning may stop automatically at that point.
- Auto scan tuning will skip weak signal stations.
- To stop the auto tuning, press the TUNING (▼ or ▲) button again.

### To receive an FM stereo transmission:

Press the TUNER button to display the “ST” indicator.

- “∞” will appear when an FM broadcast is in stereo.
- If the FM reception is weak, press the TUNER button to extinguish the “ST” indicator. The reception changes to monaural, and the sound becomes clearer.

FM stereo mode indicator



FM stereo receiving indicator

## Listening to the radio (continued)

### ■ Memorizing a station

You can store 40 AM and FM stations in memory and recall them at the push of a button. (Preset tuning)

**1 Perform steps 1 - 3 in "Tuning" on page 23.**

**2 Press the MEMORY button to enter the preset tuning saving mode.**



**3 Within 30 seconds, press the ◀◀ or ▶▶ button to select the preset channel number.**

Store the stations in memory, in order, starting with preset channel 1.

**4 Within 30 seconds, press the MEMORY button to store that station in memory.**

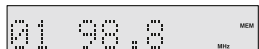

If the "MEMORY" and preset number indicators disappear before the station is memorized, repeat the operation from step 2.

**5 Repeat steps 1 - 4 to set other stations, or to change a preset station.**

When a new station is stored in memory, the station previously memorized for that preset channel number will be erased.

#### Note:

The backup function protects the memorized stations for a few hours should there be a power failure or the AC power cord becomes disconnected.

### ■ To recall a memorized station

Press the ◀◀ or ▶▶ button for less than 0.5 seconds to select the desired station.

### ■ To scan the preset stations

The stations saved in memory can be scanned automatically. (Preset memory scan)

- 1 Press the ◀◀ or ▶▶ button for more than 0.5 seconds. The preset number will flash and the programmed stations will be tuned in sequentially, for 5 seconds each.
- 2 Press the ◀◀ or ▶▶ button again when the desired station is located.

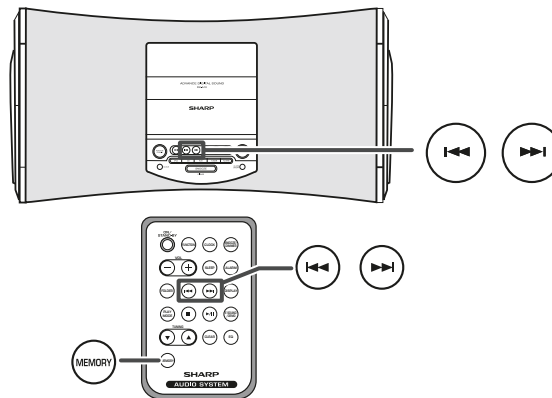

### ■ To erase entire preset memory

- 1 Press and hold the CLEAR button for more than 3 seconds. "TUN CLEAR" will be displayed.
- 2 Within 10 seconds, press the MEMORY button. "COMPLETE" will be displayed.





# Alarm and sleep operation

## ■ Alarm

The unit turns on and play desired source (iPod, CD, TUNER, AUX) or Buzzer sound for 30 minutes.

### Before setting the alarm:

- 1 Check that the clock is set to the correct time (refer page 13). If it is not set, you cannot use the alarm function.
- 2 For iPod playback: Insert iPod to the unit.
- 3 For TUNER: Set preset memory.
- 4 For CD playback: Insert disc to the unit.



### Setting the alarm content

**1 Press and hold the ALARM button for more than 2 seconds.**

**2 Press the ◀◀ or ▶▶ button to select source or buzzer.**

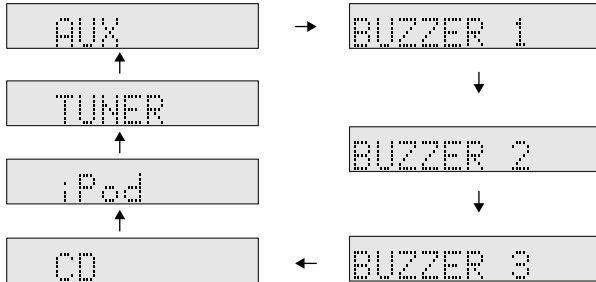

- If TUNER is selected, press the ◀◀ or ▶▶ button to select a preset station.

Press the ALARM button.

**3 Press the ◀◀ or ▶▶ button to adjust the hour.  
Press the ALARM button.**

**4 Press the ◀◀ or ▶▶ button to adjust the minute.  
Press the ALARM button.**

**5 If other than BUZZER is selected in step 2, press the ◀◀ or ▶▶ button to select volume.  
Press the ALARM button.**

### Changing alarm source only

- After source is selected in step 2, press and hold the ALARM button.
- If TUNER is selected, press and hold the ALARM button after preset station is selected in step 3.
- The time and volume will be automatically set to the previous setting.

### Activating and deactivating the alarm

- 1 Press the ALARM ON/OFF button on main unit to activate and deactivate the alarm function. When activated:
  - During power on, "ALARM" will appear.
  - During stand-by mode, ALARM indicator will light up.
- 2 Set to CLOCK function or stand-by mode.

### Checking the alarm setting

- Press the ALARM button.
  - The selected source or buzzer type will blink.
  - The unit will display the alarm time for 3 seconds.
  - During stand-by mode, the display will remain for 6 seconds.
- Example: The time is 10:00 AM and iPod function is selected.



### Notes:

- **Buzzer sound will be output from right speaker only.**
- Alarm will not activate during power on mode.
- When iPod is selected in step 2, if iPod unit is not detected during alarm activation, source will automatically change to BUZZER 1.
- When performing alarm using another unit connected to AUX, select AUX in step 2. The unit will turn on and enter the stand-by mode automatically, however, the connected unit to AUX will not turn on or off.

## ■ Snooze function

Once timer playback has started, pressing the SNOOZE/DIMMER button will stop playback for 5 minutes.

Once the snooze time has expired, playback will continue.

## ■ To turn off the alarm function

During alarm or snooze, press the ALARM ON/OFF button to turn off.

## Alarm and sleep operation (continued)

### ■ Sleep operation

The radio and iPod can be turned off automatically.

#### 1 Play back the desired sound source.

#### 2 Press the SLEEP button to select sleep time.

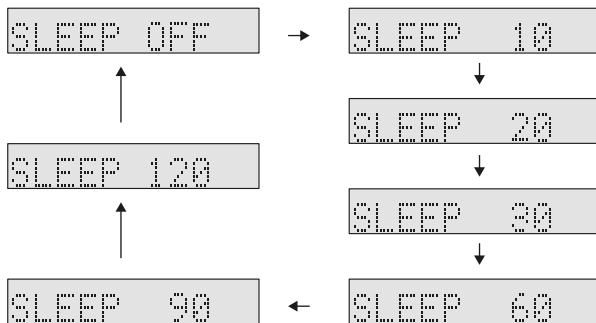

#### 3 Press the MEMORY button.

"SLEEP" will appear.



#### 4 The unit will enter the power stand-by mode automatically after the preset time has elapsed.

The volume will be turned down 1 minute before the sleep operation finishes.

### To confirm the remaining sleep time:

- 1 While "SLEEP" is indicated, press the SLEEP button once to select "SLEEP XXX".  
"XXX" is sleep remaining time.
  - The remaining sleep time is displayed for about 10 seconds.
  - You can change the remaining sleep time while it is displayed by pressing the SLEEP button (steps 2 - 3).

### To cancel the sleep operation:

Press the ON/STAND-BY button while "SLEEP" is indicated. To cancel the sleep operation without setting the unit to the stand-by mode, proceed as follows.

- 1 While "SLEEP" is indicated, press the SLEEP button to select "SLEEP OFF", and press the MEMORY button.

### ■ To use alarm and sleep operation together

#### Sleep and alarm:

For example, you can fall asleep listening to the radio and wake up to iPod in the next morning.

- 1 Set the sleep time (see left, steps 1 - 4).
- 2 While the sleep timer is set, set the alarm (steps 1 - 5, page 25).

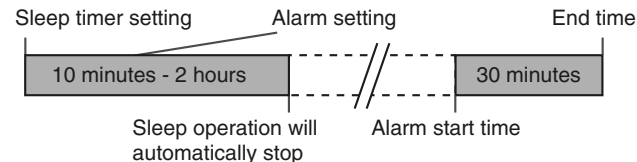

# Enhancing your system

The connection cord is not included. Purchase a commercially available cord as shown below.

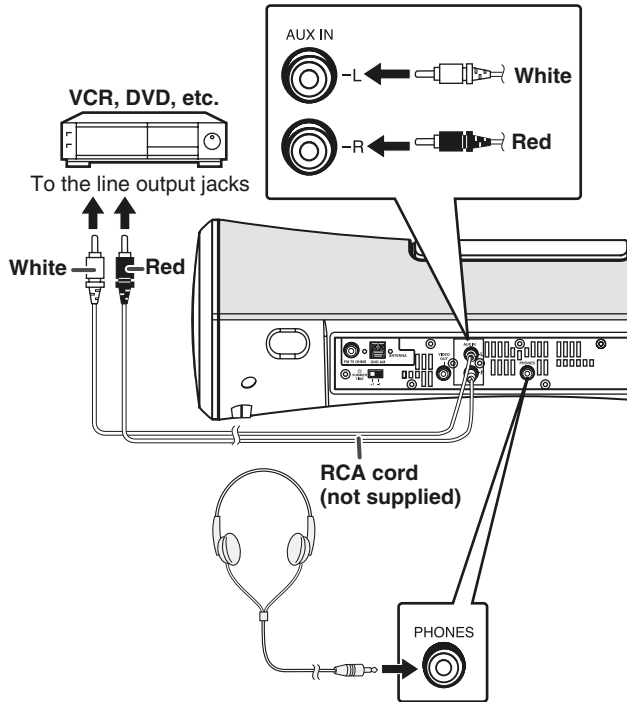

## Auto power on function:

When you press any of the following buttons, the unit turns on.

- AUX button (main unit): The unit turns on and the AUX function is activated.
- ► / || button (main unit and remote control): The unit turns on and playback of the last function starts (iPod, CD, TUNER, AUX).

## ■ Listening to the playback sounds from VCR, DVD, etc.

- 1 Use a connection cord to connect the VCR, DVD etc. to the AUX IN jacks.

When using video equipment, connect the audio output to this unit and the video output to a television.

- 2 Press the ON/STAND-BY button to turn the power on.
- 3 Press the AUX button on the main unit once or press the FUNCTION button on remote control repeatedly to select AUX.
- 4 Play the connected equipment.

## Note:

To prevent noise interference, place the unit away from the television.

## ■ Headphones

- Before plugging in or unplugging the headphones, reduce the volume.
- Be sure your headphones have a 1/8" (3.5 mm) diameter plug and impedance between 16 and 50 ohms. The recommended impedance is 32 ohms.
- Plugging in the headphones disconnects the speakers automatically. Adjust the volume using the VOL (+ or -) control.
- During alarm activation, sound will be output to the speaker even if headphones is plugged in.

# Troubleshooting chart

Many potential problems can be resolved by the owner without calling a service technician.

If something is wrong with this product, check the following before calling your authorized SHARP dealer or service center.

## ■ General

Symptom	Possible cause
<ul style="list-style-type: none"> <li>The clock is not set to the correct time.</li> </ul>	<ul style="list-style-type: none"> <li>Is the ST switch set to the correct setting?</li> <li>Did a power failure occur? Reset the clock.</li> </ul>
<ul style="list-style-type: none"> <li>When a button is pressed, the unit does not respond.</li> </ul>	<ul style="list-style-type: none"> <li>Set the unit to the power stand-by mode and then turn it back on.</li> <li>If the unit still malfunctions, reset it.</li> </ul>
<ul style="list-style-type: none"> <li>No sound is heard.</li> </ul>	<ul style="list-style-type: none"> <li>Is the volume level set to "0"?</li> <li>Are the headphones connected?</li> </ul>

## ■ Remote control

Symptom	Possible cause
<ul style="list-style-type: none"> <li>The remote control does not operate.</li> </ul>	<ul style="list-style-type: none"> <li>Is the AC power cord of the unit plugged in?</li> <li>Is the battery polarity correct?</li> <li>Are the batteries dead?</li> <li>Is the distance or angle incorrect?</li> <li>Does the remote control sensor receive strong light?</li> </ul>

## ■ Tuner

Symptom	Possible cause
<ul style="list-style-type: none"> <li>The radio makes unusual noises continuously.</li> </ul>	<ul style="list-style-type: none"> <li>Is the unit placed near the TV or computer?</li> <li>Is the FM antenna or AM loop antenna placed properly? Move the antenna away from the AC power cord if it's located nearby.</li> </ul>

## ■ CD player

Symptom	Possible cause
<ul style="list-style-type: none"> <li>Playback does not start.</li> <li>Playback stops in the middle or is not performed properly.</li> </ul>	<ul style="list-style-type: none"> <li>Is the disc loaded upside down?</li> <li>Does the disc satisfy the standards?</li> <li>Is the disc distorted or scratched?</li> </ul>
<ul style="list-style-type: none"> <li>Playback sounds are skipped, or stopped in the middle of a track.</li> </ul>	<ul style="list-style-type: none"> <li>Is the unit located near excessive vibrations?</li> <li>Is the disc very dirty?</li> <li>Has condensation formed inside the unit?</li> </ul>

## ■ iPod

Symptom	Possible cause
<ul style="list-style-type: none"> <li>No sound is produced. No image appears on the TV/monitor.</li> </ul>	<ul style="list-style-type: none"> <li>The iPod is not playing.</li> <li>The iPod is not properly connected to the unit.</li> <li>Is the AC power cord of the unit plugged in?</li> <li>The video cable is not properly connected.</li> <li>The TV/monitor's input selection is not properly set.</li> </ul>
<ul style="list-style-type: none"> <li>iPod will not charge</li> </ul>	<ul style="list-style-type: none"> <li>Wrong iPod adaptor is used.</li> <li>The iPod is not making full contact with the iPod connector.</li> <li>The main unit is in stand-by mode.</li> </ul>

## ■ Condensation

Sudden temperature changes, storage or operation in an extremely humid environment may cause condensation inside the cabinet or on the transmitter on the remote control.

Condensation can cause the unit to malfunction. If this happens, leave the power on **with no disc** until normal playback is possible (about 1 hour). Wipe off any condensation on the transmitter with a soft cloth before operating the unit.

### ■ If trouble occurs

When this product is subjected to strong external interference (mechanical shock, excessive static electricity, abnormal supply voltage due to lightning, etc.) or if it is operated incorrectly, it may malfunction.

#### If such a problem occurs, do the following:

- 1 Set the unit to the stand-by mode and turn the power on again.
- 2 If the unit is not restored in the previous operation, unplug and plug in the unit, and then turn the power on.

#### Note:

If neither operation above restores the unit, clear all the memory by resetting it.

### ■ Clearing all the memory (reset)

- 1 Press the ON/STAND-BY button to enter the power stand-by mode.
- 2 While pressing down the SNOOZE/DIMMER button and the E SOUND/DEMO button, press the ON/STAND-BY button until "CLEAR ALL" appears.



#### Caution:

This operation will erase all data stored in memory including clock, alarm settings and tuner preset.

### ■ Before transporting the unit

Remove the iPod and the disc from the unit. Then, set the unit to the power stand-by mode. Carrying the unit with iPod left docked might damage both the unit and the iPod.

## Maintenance

### ■ Cleaning the cabinet

Periodically wipe the cabinet with a soft cloth and a diluted soap solution, then with a dry cloth.

#### Caution:

- Do not use chemicals for cleaning (gasoline, paint thinner, etc.). It may damage the cabinet finish.
- Do not apply oil to the inside of the unit. It may cause malfunctions.

## Specifications

As part of our policy of continuous improvement, SHARP reserves the right to make design and specification changes for product improvement without prior notice. The performance specification figures indicated are nominal values of production units. There may be some deviations from these values in individual units.

### ■ General

<b>Power source</b>	AC 120 V, 60 Hz
<b>Power consumption</b>	33 W
<b>Output power</b>	Front speakers: RMS: 4W (2W + 2W) (10% T.H.D.) Subwoofer: RMS: 10W (5W + 5W) (10% T.H.D.)
<b>Speaker</b>	1-way type light-up speaker system Front Speaker: 2-1/2" (6.5 cm) - 12 ohms - Full Range Subwoofer: 4" (10 cm) - 8 ohms - Full Range
<b>Speaker maximum input power</b>	Front Speakers: 4W Subwoofer: 10W
<b>Speaker rated input power</b>	Front Speakers: 2W Subwoofer: 5W
<b>Output terminals</b>	Headphones: 16 - 50 ohms (recommended: 32 ohms) Video output: 1Vp-p
<b>Input terminals</b>	Auxiliary (audio signal): 500 mV/47 k ohms
<b>Dimensions</b>	Width: 19-11/16" (500 mm) Height: 5-7/8" (150 mm) Depth: 9-7/8" (250 mm)
<b>Weight</b>	11.7 lbs. (5.3 kg)

### ■ Tuner

<b>Frequency range</b>	FM: 87.5 - 108 MHz AM: 530 - 1,720 kHz
------------------------	---

## CONSUMER LIMITED WARRANTY

SHARP ELECTRONICS CORPORATION warrants to the first consumer purchaser that this Sharp brand product (the "Product"), when shipped in its original container, will be free from defective workmanship and materials, and agrees that it will, at its option, either repair the defect or replace the defective Product or part thereof with a new or remanufactured equivalent at no charge to the purchaser for parts or labor for the period(s) set forth below.

This warranty does not apply to any appearance items of the Product nor to the additional excluded item(s) set forth below nor to any Product the exterior of which has been damaged or defaced, which has been subjected to improper voltage or other misuse, abnormal service or handling, or which has been altered or modified in design or construction.

In order to enforce the rights under this limited warranty, the purchaser should follow the steps set forth below and provide proof of purchase to the servicer.

The limited warranty described herein is in addition to whatever implied warranties may be granted to purchasers by law. ALL IMPLIED WARRANTIES INCLUDING THE WARRANTIES OF MERCHANTABILITY AND FITNESS FOR USE ARE LIMITED TO THE PERIOD(S) FROM THE DATE OF PURCHASE SET FORTH BELOW. Some states do not allow limitations on how long an implied warranty lasts, so the above limitation may not apply to you.

Neither the sales personnel of the seller nor any other person is authorized to make any warranties other than those described herein, or to extend the duration of any warranties beyond the time period described herein on behalf of Sharp.

The warranties described herein shall be the sole and exclusive warranties granted by Sharp and shall be the sole and exclusive remedy available to the purchaser. Correction of defects, in the manner and for the period of time described herein, shall constitute complete fulfillment of all liabilities and responsibilities of Sharp to the purchaser with respect to the Product, and shall constitute full satisfaction of all claims, whether based on contract, negligence, strict liability or otherwise. In no event shall Sharp be liable, or in any way responsible, for any damages or defects in the Product which were caused by repairs or attempted repairs performed by anyone other than an authorized servicer. Nor shall Sharp be liable or in any way responsible for any incidental or consequential economic or property damage. Some states do not allow the exclusion of incidental or consequential damages, so the above exclusion may not apply to you.

THIS WARRANTY GIVES YOU SPECIFIC LEGAL RIGHTS. YOU MAY ALSO HAVE OTHER RIGHTS WHICH VARY FROM STATE TO STATE.

### **Model Specific Section**

#### **Your Product Model Number & Description:**

**DK-A10/DK-A10BK**

(Be sure to have this information available when you need service for your Product.)

#### **Warranty Period for this Product:**

One (1) year parts and labor from the date of purchase.

#### **Additional Item(s) Excluded from Warranty Coverage (if any):**

Non-functional accessories, supplies, and consumable items.

#### **Where to Obtain Service:**

At a Sharp Authorized Servicer located in the United States.

To find a location of the nearest Sharp Authorized Servicer, call Sharp toll free at 1-800-BE-SHARP.

#### **What to do to Obtain Service:**

Ship prepaid or carry in your Product to a Sharp Authorized Servicer.

Be sure to have **Proof of Purchase** available. If you ship the Product, be sure it is insured and packaged securely.

TO OBTAIN SUPPLY, ACCESSORY OR PRODUCT INFORMATION, CALL **1-800-BE-SHARP**.

# SHARP

**SHARP ELECTRONICS CORPORATION**

Sharp Plaza, Mahwah, New Jersey 07430-2135

**SHARP CORPORATION**

Printed in Malaysia

TINSEA155AWZZ

07B R KI ①