

JVC



JLIP VIDEO CAPTURE DOCKING STATION BASE DE MONTAGE A CAPTURE VIDEO JLIP

GV-DS1

ENGLISH

FRANÇAIS

JLIP

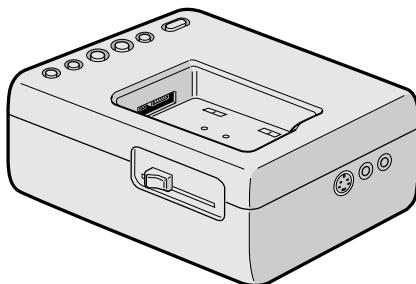

INSTRUCTIONS **MODE D'EMPLOI**

For Customer Use:

Enter below the Serial No. of the
GV-DS1U JLIP VIDEO CAPTURE
DOCKING STATION.

The serial number is located on the
bottom of the JLIP VIDEO CAPTURE
DOCKING STATION.

Model No. **GV-DS1U**

Serial No. _____

Dear Customer,

Thank you for purchasing this VIDEO CAPTURE DOCKING STATION. Before use, please read the safety information and precautions contained in the following pages to ensure safe use of this product.

Using This Instruction Manual

- All major sections and subsections are listed in the Table Of Contents (☞ pg. 8, 9).
- Notes appear after most subsections. Be sure to read these as well.
- Basic and advanced features/operation are separated for easier reference.

It is recommended that you . . .

- refer to "Controls and Connectors" (☞ pg. 11) and familiarize yourself with connector locations before use.
- read thoroughly the Safety Precautions and Safety Instructions that follow. They contain extremely important information regarding the safe use of your new VIDEO CAPTURE DOCKING STATION.

You are recommended to carefully read the cautions on pgs. 5 and 6 before use.

Declaration of Conformity

Model Number : GV-DS1U
 Trade Name : JVC
 Responsible party : US JVC CORP.
 Address : 41 Slater Drive, Elmwood Park,
 N. J. 07407

Telephone Number : (201) 794-3900

This device complies with Part 15 of FCC Rules.

Operation is subject to the following two conditions:

- (1) This device may not cause harmful interference, and
- (2) this device must accept any interference received, including interference that may cause undesired operation.

Change or modifications not approved by the party responsible for compliance could void the user's authority to operate the equipment. This equipment has been tested and found to comply with the limits for a Class B digital device, pursuant to Part 15 of the FCC Rules. These limits are designed to provide reasonable protection against harmful interference in a residential installation. This equipment generates, uses, and can radiate radio frequency energy and, if not installed and used in accordance with the instructions, may cause harmful interference to radio communications.

However, there is no guarantee that interference will not occur in a particular installation.

If this equipment does cause harmful interference to radio or television reception, which can be determined by turning the equipment off and on, the user is encouraged to try to correct the interference by one or more of the following measures:

Reorient or relocate the receiving antenna.

Increase the separation between the equipment and receiver.

Connect the equipment into an outlet on a circuit different from that to which the receiver is connected. Consult the dealer or an experienced radio/TV technician for help.

SAFETY PRECAUTIONS

CAUTION:

TO REDUCE THE RISK OF FIRE, DO NOT REMOVE COVER (OR BACK). NO USER-SERVICEABLE PARTS INSIDE. REFER SERVICING TO QUALIFIED SERVICE PERSONNEL.

WARNING:
TO PREVENT FIRE OR SHOCK HAZARD, DO NOT EXPOSE THIS UNIT TO RAIN OR MOISTURE.

NOTE:

The rating plate (serial number plate) and safety caution are on the bottom of the VIDEO CAPTURE DOCKING STATION.

This Class B digital apparatus meets all requirements of the Canadian Interference – Causing Equipment Regulations.

“Cet appareil numérique de la classe B respecte toutes les exigences du Règlement sur le matériel brouilleur du Canada.”

When using the Video Capture Docking Station, use the AA-V80U AC Adapter/Charger (optional or provided with the camcorder).

IMPORTANT PRODUCT SAFETY INSTRUCTIONS

Electrical energy can perform many useful functions. But improper use can result in potential electrical shock or fire hazards. This product has been engineered and manufactured to assure your personal safety. In order not to defeat the built-in safeguards, observe the following basic rules for its installation, use and servicing.

ATTENTION:

Follow and obey all warnings and instructions marked on your product and its operating instructions. For your safety, please read all the safety and operating instructions before you operate this product and keep this manual for future reference.

INSTALLATION

1. Grounding or Polarization

Your product may be equipped with a polarized alternating-current line plug (a plug having one blade wider than the other). This plug will fit into the power outlet only one way. This is a safety feature. If you are unable to insert the plug fully into the outlet, try reversing the plug. If the plug should still fail to fit, contact your electrician to replace your obsolete outlet. Do not defeat the safety purpose of the polarized plug.

2. Power Sources

Operate your product only from the type of power source indicated on the marking label. If you are not sure of the type of power supply to your home, consult your product dealer or local power company. If your product is intended to operate from battery power, or other sources, refer to the operating instructions.

3. Overloading

Do not overload wall outlets, extension cords, or integral convenience receptacles as this can result in a risk of fire or electric shock.

4. Power Cord Protection

Power supply cords should be routed so that they are not likely to be walked on or pinched by items placed upon or against them, paying particular attention to cords at plugs, convenience receptacles, and the point where they exit from the product.

5. Ventilation

Slots and openings in the cabinet are provided for ventilation. To ensure reliable operation of the product and to protect it from overheating, these openings must not be blocked or covered.

- Do not block the openings by placing the product on a bed, sofa, rug or other similar surface.
- Do not place the product in a built-in installation such as a bookcase or rack unless proper ventilation is provided or the manufacturer's instructions have been adhered to.

6. Wall or Ceiling Mounting

The product should be mounted to a wall or ceiling only as recommended by the manufacturer.

ANTENNA INSTALLATION INSTRUCTIONS

1. Outdoor Antenna Grounding

If an outside antenna or cable system is connected to the product, be sure the antenna or cable system is grounded so as to provide some protection against voltage surges and built-up static charges. Article 810 of the National Electrical Code, ANSI/NFPA 70, provides information with regard to proper grounding of the mast and supporting structure, grounding of the lead-in wire to an antenna discharge unit, size of grounding conductors, location of antenna discharge unit, connection to grounding electrodes, and requirements for the grounding electrode.

2. Lightning

For added protection for this product during a lightning storm, or when it is left unattended and unused for long periods of time, unplug it from the wall outlet and disconnect the antenna or cable system. This will prevent damage to the product due to lightning and power-line surges.

3. Power Lines

An outside antenna system should not be located in the vicinity of overhead power lines or other electric light or power circuits, or where it can fall into such power lines or circuits. When installing an outside antenna system, extreme care should be taken to keep from touching such power lines or circuits as contact with them might be fatal.

EXAMPLE OF ANTENNA GROUNDING AS PER NATIONAL ELECTRICAL CODE, ANSI/NFPA 70

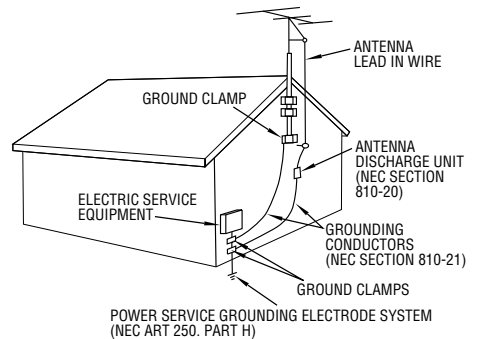

NEC – NATIONAL ELECTRICAL CODE

USE

1. Accessories

To avoid personal injury:

- Do not place this product on an unstable cart, stand, tripod, bracket or table. It may fall, causing serious injury to a child or adult, and serious damage to the product.
- Use only with a cart, stand, tripod, bracket, or table recommended by the manufacturer or sold with the product.
- Use a mounting accessory recommended by the manufacturer and follow the manufacturer's instructions for any mounting of the product.
- Do not try to roll a cart with small casters across thresholds or deep-pile carpets.

2. Product and Cart Combination

A product and cart combination should be moved with care. Quick stops, excessive force, and uneven surfaces may cause the product and cart combination to overturn.

3. Water and Moisture

Do not use this product near water—for example, near a bath tub, wash bowl, kitchen sink or laundry tub, in a wet basement, or near a swimming pool and the like.

PORTABLE CART WARNING
(Symbol provided by RETAC)



4. Object and Liquid Entry

Never push objects of any kind into this product through openings as they may touch dangerous voltage points or short-out parts that could result in a fire or electric shock. Never spill liquid of any kind on the product.

5. Attachments

Do not use attachments not recommended by the manufacturer of this product as they may cause hazards.

6. Cleaning

Unplug this product from the wall outlet before cleaning. Do not use liquid cleaners or aerosol cleaners. Use a damp cloth for cleaning.

7. Heat

The product should be situated away from heat sources such as radiators, heat registers, stoves, or other products (including amplifiers) that produce heat.

SERVICING

1. Servicing

If your product is not operating correctly or exhibits a marked change in performance and you are unable to restore normal operation by following the detailed procedure in its operating instructions, do not attempt to service it yourself as opening or removing covers may expose you to dangerous voltage or other hazards. Refer all servicing to qualified service personnel.

2. Damage Requiring Service

Unplug this product from the wall outlet and refer servicing to qualified service personnel under the following conditions:

- When the power supply cord or plug is damaged.
- If liquid has been spilled, or objects have fallen into the product.
- If the product has been exposed to rain or water.
- If the product does not operate normally by following the operating instructions. Adjust only those controls that are covered by the operating instructions as an improper adjustment of other controls may result in damage and will often require extensive work by a qualified technician to restore the product to its normal operation.
- If the product has been dropped or damaged in any way.
- When the product exhibits a distinct change in performance—this indicates a need for service.

3. Replacement Parts

When replacement parts are required, be sure the service technician has used replacement parts specified by the manufacturer or have the same characteristics as the original part. Unauthorized substitutions may result in fire, electric shock or other hazards.

4. Safety Check

Upon completion of any service or repairs to this product, ask the service technician to perform safety checks to determine that the product is in safe operating condition.

If you notice smoke or a peculiar smell coming from the VIDEO CAPTURE DOCKING STATION unplug it IMMEDIATELY. Use of the VIDEO CAPTURE DOCKING STATION under these conditions could lead to fire or electric shock. Contact your JVC dealer. DO NOT attempt to repair the malfunction yourself.

DO NOT attempt to insert foreign objects into the connectors, as this can lead to electric shock or fire. If an object is accidentally inserted, unplug it and contact your JVC dealer. Be especially careful with children.

If during use you notice that the VIDEO CAPTURE DOCKING STATION is damaged, unplug it and contact your JVC dealer. Use of the VIDEO CAPTURE DOCKING STATION under these conditions can lead to fire or electric shock.

DO NOT attempt to repair or modify the VIDEO CAPTURE DOCKING STATION. Doing so may result in malfunctions or injury. If a problem occurs, contact your JVC dealer.

Failure to heed the following precautions may result in damage to the VIDEO CAPTURE DOCKING STATION.

1. **DO NOT** place the VIDEO CAPTURE DOCKING STATION . . .
 - in an environment prone to extreme temperatures or humidity.
 - in direct sunlight.
 - in a dusty environment.
 - in an environment where strong magnetic fields are generated.
 - on a surface that is unstable or subject to vibration. The unit may fall, causing injury.
2. **DO NOT** place heavy objects on the VIDEO CAPTURE DOCKING STATION.
3. **DO NOT** place anything which might spill on top of the VIDEO CAPTURE DOCKING STATION.
4. **AVOID** violent shocks to the VIDEO CAPTURE DOCKING STATION during transport.
5. **DO NOT** leave the AC Adapter/charger plugged in when the VIDEO CAPTURE DOCKING STATION is not in use.
6. **DO NOT** use accessories other than those designated in the instructions. Use of others can lead to fire or electric shock.
7. **DO NOT** connect devices to the VIDEO CAPTURE DOCKING STATION other than those designated in the instructions. Use of others can lead to malfunctions.

How to handle a CD-ROM

- Take care not to soil or scratch the mirror surface (opposite to the printed surface). Do not write anything or put a sticker on either the front or back surface. If the CD-ROM gets dirty, gently wipe it with a soft cloth outward from the center hole using a circular motion.
- Do not use conventional disc cleaners or cleaning spray.
- Do not bend the CD-ROM or touch its mirror surface.
- Do not store your CD-ROM in a dusty, hot or humid environment. Keep it away from direct sunlight.

MAINTENANCE

If the inside of the VIDEO CAPTURE DOCKING STATION is left in a dusty environment for a long time, its use can lead to fire or malfunction. Consult your JVC dealer on cleaning.

CAUTION:

Changes or modifications not approved by JVC could void user's authority to operate the equipment.

- **The Readme.TXT file provides additional information for setup and information that is not included in the instruction manual. Please read the file before installing the provided software program.**
- **You can find the latest information (in English) on the provided software program at our world wide web server at <http://www.jvc-victor.co.jp/>**

Two software programs are provided with the GV-DS1 JLIP package.

JLIP Video Capture Software

(☞ pg. 12 – 39)

JLIP Video Capture Software

This is the software described in this manual.

Video Capture Facility

Video images from video source units such as camcorders or VCRs can be captured as 640 x 480 still images with 16.77 million colors through the serial port (RS-232C) of a Windows®-operated computer.

JLIP Control Facility

With a JLIP compatible camcorder or VCR,

- all basic video operations can be executed via the computer display;
- Up to 99 images can be captured automatically with Program Video Capture (playing tape — scanning — transferring to PC)

Data Sharing With JLIP Player Software

Data can be imported from the JLIP Player Software.

Data from the Video Capture Software can also be exported to the Player Software for Program Playback or Assemble Editing.

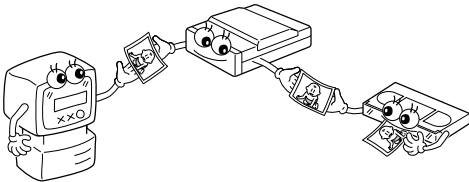

JLIP Player Software

(☞ pg. 41 – 65)

JLIP Control Facility

With a JLIP-compatible camcorder, VCR or video printer (GV-PT1, GV-PT2):

- all basic video operations can be executed on the computer display;
- allows programmed video playback (up to 99 programs) or assemble editing
- allows image adjustment on the GV-PT1 video printer
- print command can be issued to the GV-PT2 video printer

Data Sharing with the Video Capture Software

Video Capture Software data can be exported to the Player Software.

Assemble Editing

Selected scenes on a pre-recorded tape can be edited in a specified sequence.

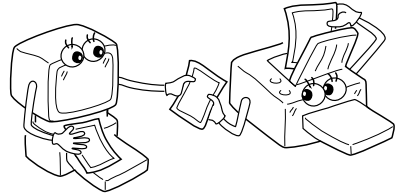

Pre-recorded tape
(on camcorder)

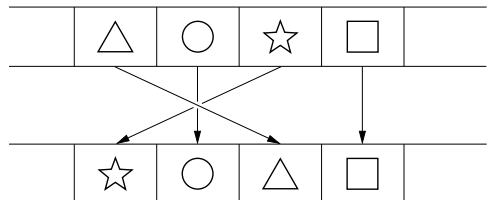

Recording tape
(on VCR)

MAJOR FEATURES	7
ADVANCED APPLICATIONS	10
CONTROLS AND CONNECTORS	11
CONNECTIONS (When Using JLIP Video Capture Software)	12
INTRODUCTION	14
INSTALLATION (JLIP Video Capture Software)	15
HOW TO OPEN THE PROGRAM	16
Preparation	16
INITIALIZATION	17
Initializing JLIP	17
Select units	18
HOW TO CLOSE THE PROGRAM	19
HOW THE DESKTOP WORKS	20
Main desktop window	20
Menu bar	21
VIDEO CAPTURE	24
Capturing video images	24
Step by step capture	25
Automatic capture	26
Program capture	26
Interval capture	28
PICTURE FORMAT SETTING	29
Selecting a picture format	29
ADDITIONAL OPERATIONS	30
Counter value change	30
Counter reset	30
Delete index image and full image	31
Change ID	31
SAVE PICTURE	32
Create new folder	32
Saving	32
Open index	33
Save the full image data	33

<i>JLIP PLAYER SOFTWARE</i>	34
Using JLIP player software data	34
How to store JLIP player software data	35
<i>TROUBLESHOOTING</i>	36
<i>LIST OF ERROR MESSAGES</i>	38
<i>JLIP PLAYER SOFTWARE SECTION</i>	41
<i>CONNECTIONS (When Using JLIP Player Software)</i>	42
When connecting to a video source unit with JLIP connector or to a video printer	42
<i>GETTING STARTED</i>	44
<i>INSTALLING (JLIP Player Software)</i>	45
<i>STARTING JLIP PLAYER SOFTWARE</i>	46
<i>MOVIE PLAYER WINDOW BUTTONS AND DISPLAYS</i>	48
<i>BASIC OPERATIONS</i>	50
<i>VIDEO PRINTER WINDOW BUTTONS AND DISPLAYS</i>	56
<i>VIDEO PRINTER OPERATION (GV-PT1)</i>	58
Printing	58
Adjusting picture equalization	59
<i>VIDEO PRINTER OPERATION (GV-PT2)</i>	60
Auto capture	60
<i>ADVANCED OPERATIONS</i>	62
Changing ID number	62
Connecting other device during operation	62
Changing the name of the device	63
Changing the device to use while connecting over two same type devices	63
Adjusting the gap between the stored edit-start point in the computer and the dubbed one in the recording deck	64
<i>TROUBLESHOOTING</i>	65
<i>MAJOR SPECIFICATIONS</i>	66
<i>INDEX</i>	67

Create title indexes for your video collection

Title index images can be captured from your favorite recordings in intervals of 30 minutes, 1 hour, 1.5 hours, etc. using the Interval Capture mode. Print the captured index images on your PC printer using the computer's Print Screen facility, then attach them to your cassettes.

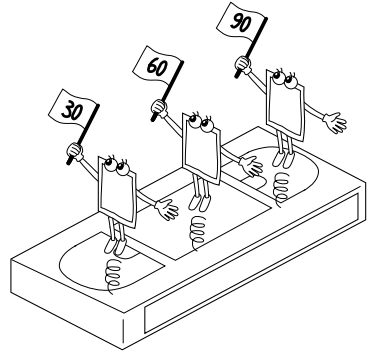

Business presentations

Images captured from video can be incorporated into business documents to spice up your presentations.

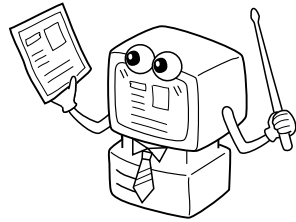

Internet homepage

Images captured from video can be incorporated in your Internet homepage using image editing software.

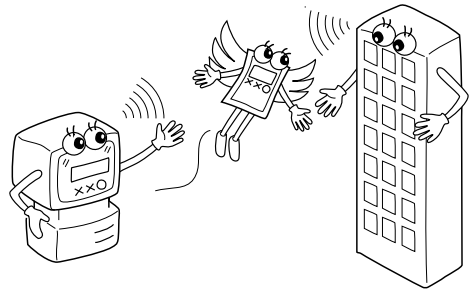

Video journal and postcards

Create your own original postcards, party invitation cards and the like or keep a video journal.

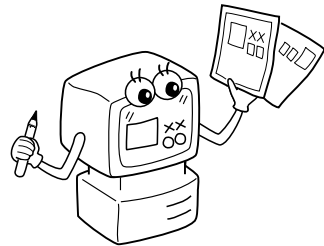

The controls and connectors marked * can be used only when the GR-DVM1 Digital Camcorder is attached. For details of its operation, read the camcorder instruction manual.

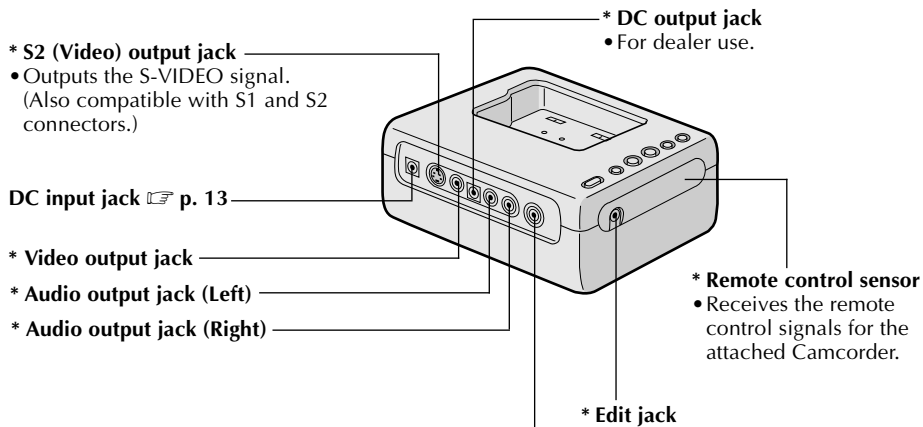
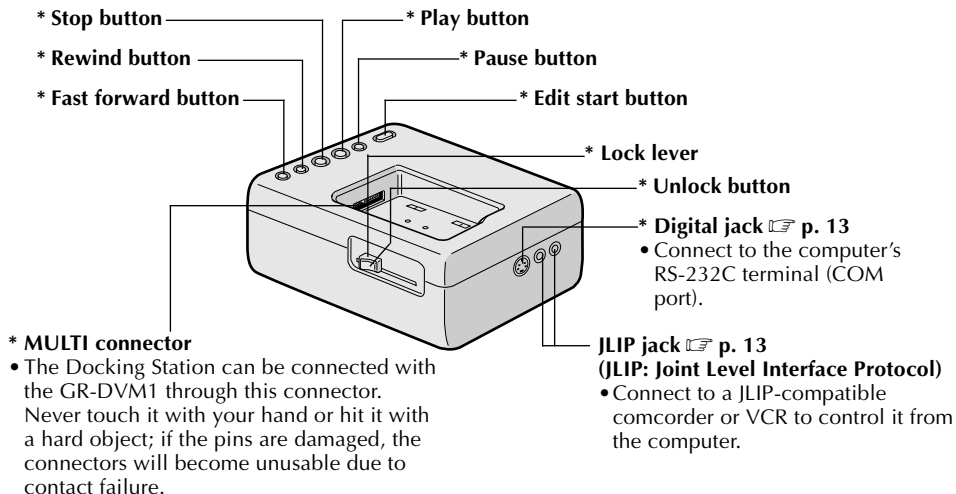

Capture input (EXT.)/printer connector

p. 13

- Connect with the video output (stored image output) of the optional video printer. Even when a TV is not connected to the video printer, this connection allows you to see the images output from the video printer on the LCD screen while printing.
- The date and timecode are not shown on the LCD screen. If you want to print out the date together with the images, connect a TV to the video output connector of the video printer and operate it by referring to the TV screen.
- It is also possible to capture images from video equipment other than the GR-DVM1 by connecting the equipment to this connector. To make this operation possible, also attach the GR-DVM1 and set its power switch to record mode without loading a tape.

- To assure safety, make sure all units are turned off before making any connections.
- The video images will be displayed on the LCD screen of the attached GR-DVM1. You cannot view the images on the computer screen.
- When connecting the provided cables, be sure to connect the terminals equipped with Core filters to the Video Capture Docking Station.
- When using the Video Capture Docking Station, use the AA-V80U AC Adapter/Charger (optional or provided with the camcorder).

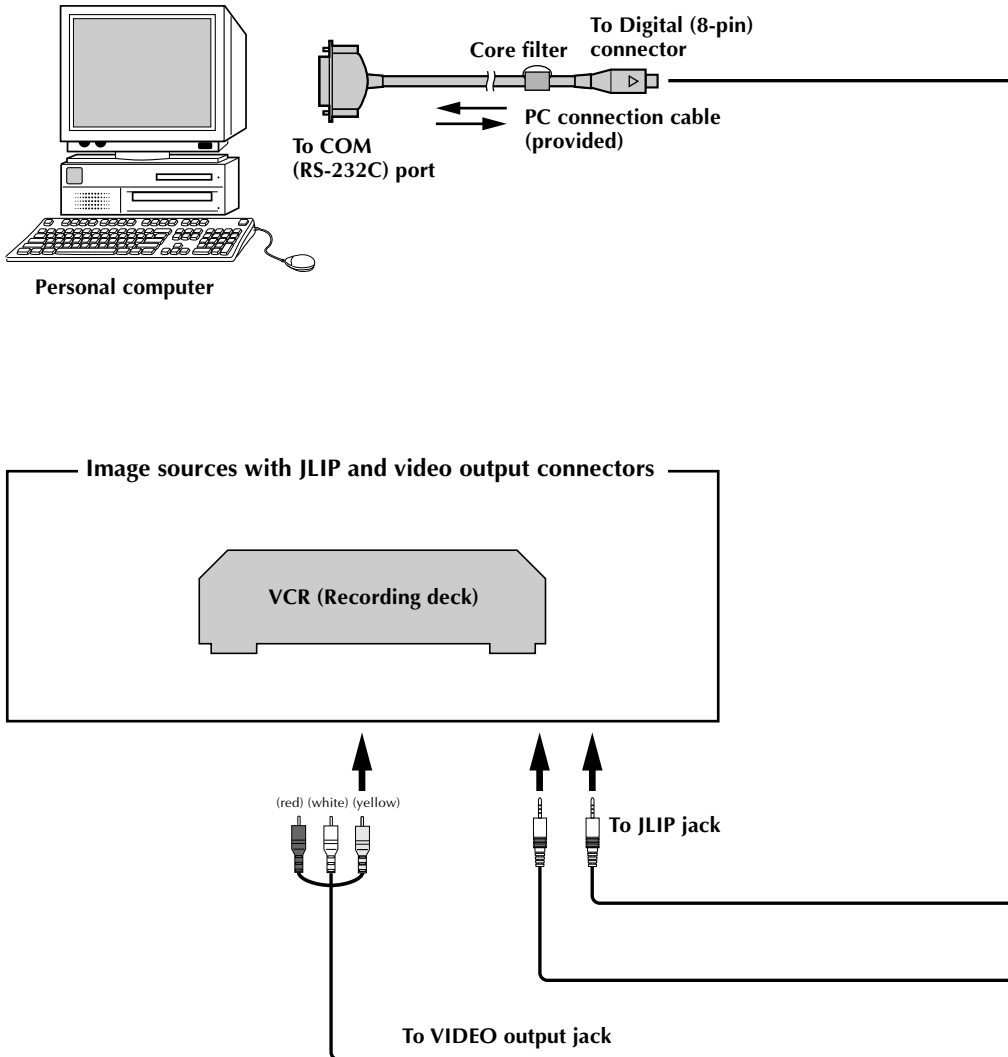

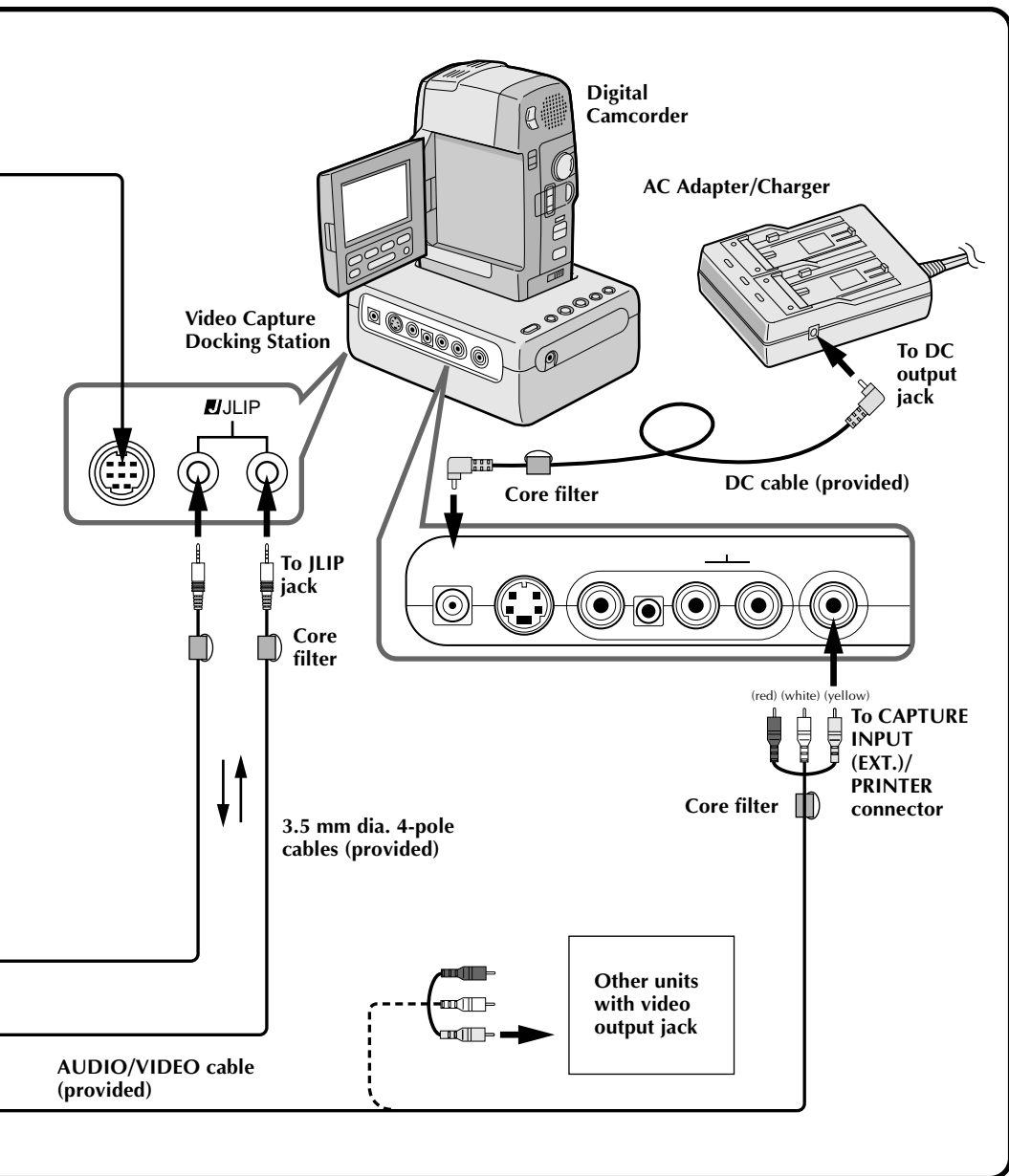

What is video capture software ?

Video capture software is a type of application program that allows you to capture video images from camcorders and VCRs and store them in personal computers running under the Windows® operating system. These images can be transferred from the video source to the computer via a standard RS-232C communication interface. By processing the captured images with commercially available image editing software, you can create your own unique and highly personal illustrations and graphics for incorporation into everything from postcards to newsletters and Internet homepages.

What is JLIP ?

JLIP* stands for Joint Level Interface Protocol, a new communication protocol which allows AV units equipped with a JLIP terminal to be controlled by a personal computer.

* **JLIP** is a registered trademark of JVC.

Operating Environment

- Personal computer with Microsoft® Windows® 3.1 or Windows® 95
- CPU Intel DX4™ or higher processor
- Minimum RAM requirement: more than 8 MB
- Available Hard Disk space of at least 8 MB
- Colour display capable of at least 640 x 480 pixels, 256 colours
Recommended 1024 x 768, 16.77 Mil colours
- 1 free serial transmission port, compatible with 9600 bps transmission rate, connectable to RS-232C with 9 pin serial connector.
Recommended compatible with UART 16550A
- Mouse (Windows® compatible)
- CD-ROM drive

Note : An optional 9 pin serial conversion adapter is required for computers using serial communication port other than standard 9 pin.

* Microsoft® and Windows® are either registered trademarks or trademarks of Microsoft Corporation in the United States and/or other countries.

* Other product and company names included in this instruction manual are trademarks and/or registered trademarks of their respective holders.

Connectable Devices

When using JLIP with Video units equipped with a JLIP connector :

- JVC camcorders or VCRs equipped with a JLIP connector.

When not using JLIP:

- Video units with video output connectors

WINDOWS® 95

Refer to the Windows® 95 manual or your computer's manual for details on basic Windows® 95 operating procedures.

Installation Procedure

*To start the setup program...

- 1** Launch Windows® 95
 - Close any other applications that are running.
- 2** Insert the "JLIP Video Capture" CD-ROM into the CD-ROM drive.
- 3** Choose "Run" from "Start" on the taskbar.
- 4** If the "JLIP Video Capture" CD-ROM is in Drive D, type "D:\JCPT\SETUP" in the box to the right of "Open". If the disk is in Drive E, type "E:\JCPT\SETUP".
 - Click "OK".
 - Once the setup program is running, simply follow the instructions displayed on-screen.
 - When setup is complete, the "JLIP Video Capture" icon appears on the screen.
 - "JLIP Video Capture Setup was completed successfully." appears.
- 5** Click "OK" to complete installation.

WINDOWS® 3.1

Refer to the Windows® 3.1 manual of or your computer manual for details on basic Windows® 3.1 operating procedures.

Installation Procedure

*To start the setup program...

- 1** Launch Windows® 3.1
 - Close any other applications that are running.
- 2** Insert the "JLIP Video Capture" CD-ROM into the CD-ROM drive.
- 3** Choose "Run" from "File" in the "Program Manager".
- 4** If the "JLIP Video Capture" CD-ROM is in Drive D, type "D:\JCPT\SETUP" in the box to the right of "Open". If the disk is in Drive E, type "E:\JCPT\SETUP".
 - Click "OK".
 - Once the setup program is running, simply follow the instructions displayed on-screen.
 - When setup is complete, the "JLIP Video Capture" icon appears on the screen.
 - "JLIP Video Capture Setup was completed successfully." appears.
- 5** Click "OK" to complete installation.

The Video Capture software can be started up in the same way as any other program running under Windows. The procedure differs slightly depending on whether you're using Windows® 3.1 or Windows® 95.

Preparation

- Turn on your computer.
- Press the POWER button to turn on the power.
- Turn on the video source units (such as camcorders and VCRs).
- If you want to capture a still picture from a recorded tape, load the tape into the video unit.
- If you want to capture an image from the data stored in the JLIP Player Software, be sure to load the disk on which the image is stored.

Close any programs that are running. You cannot run other programs simultaneously with the Video Capture software.

With Windows® 3.1, open the group of application icons in the Program Manager and double-click the application icon you want to launch.

With Windows® 95, click the [START] button on the taskbar, and the Program menu appears on the screen. Move the mouse pointer over the program entry you want to run and click to start the program.

Now let's start the program.

If you're using Windows® 3.1, open the JLIP Video Capture group in the "Program Manager" and double-click the JLIP Video Capture icon.

If you're using Windows® 95, select JLIP Video Capture from the "Start menu" and click to start.

INITIALIZING JLIP

The first time you start the Video Capture software, JLIP initialization is required. This sets which of the computer's COM ports (connector into which the RS-232C cable is plugged) is connected to the GV-CB1 JLIP Video Capture Docking Station. The initialization window automatically appears the first time you start the software after installation. Do not forget to carry out this JLIP initialization procedure. The JLIP must be initialized again whenever you connect a new image source or other unit to the JLIP Video Capture Docking Station.

1. Start the JLIP Video Capture software.
2. The "**JLIP Initialization**" screen automatically appears.
3. Select "**COM Port**".
 - COM1 through COM4 ports are available. Check to see which COM port is connected to the JLIP Video Capture Box and select it.
4. Select "**Transfer Rate**".
 - Normally select 38400.
 - 38400 may not be available on some computers. When transmission errors take place during use, switch to 19200 or 9600. Image data transmission will be slower at these speeds.
5. Click "**OK**". The "**JLIP Initialization**" window appears while the program checks for the connected units.

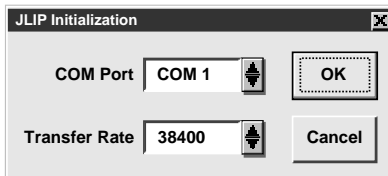

NOTE : If you want to change a unit or COM port or Transfer Rate, select "**Initialize**" from "**Set-up**" in the menu bar to call up the "**JLIP Initialization**" window. Repeat this setting procedure.

If a connection is incorrect, a connected unit is not turned on, or the connection ID numbers overlap, the message "Connection error" appears. Click "**OK**" to return to the Main desktop.

SELECT UNITS

6. The "**Device Selection**" window appears, listing the JLIP devices.
7. Click the name of the desired unit.
 - The word "**VCRCAMERA**" appears in the VCR box to indicate the Video source unit is now in use.
 - The word "**MODULE**" appears in the **Video Capture** box to indicate the Video Capture Docking Station is now in use.
 - Only one VCR and one Video Capture device can be selected.
8. Click "**OK**".
 - The main desktop window returns (setting complete).

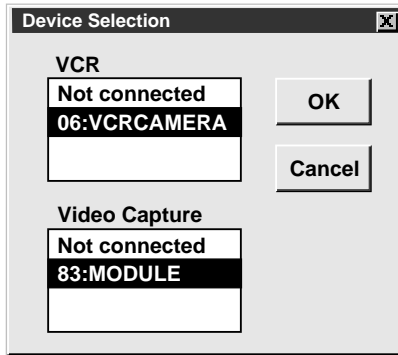

NOTE : The "**Device Selection**" window automatically appears when JLIP initialization is complete. However, if you want to select equipment whose JLIP initialization has already been carried out, select "**Device Change**" from "**Set-up**" in the menu bar to call up the "**Device Selection**" window.

Double-click the control menu button in Windows® 3.1 or click "Exit" in the "File" menu.

In Windows® 95, simply click the Close button.

If you try to close the program with no image saved, the message "**The album has not been saved. Save?**" appears. Please note that if you close without saving, all unsaved captured data will be deleted.

- 1 Click "Exit" from "File" in the menu bar.
 - The program closes.

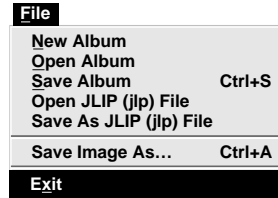

MAIN DESKTOP WINDOW

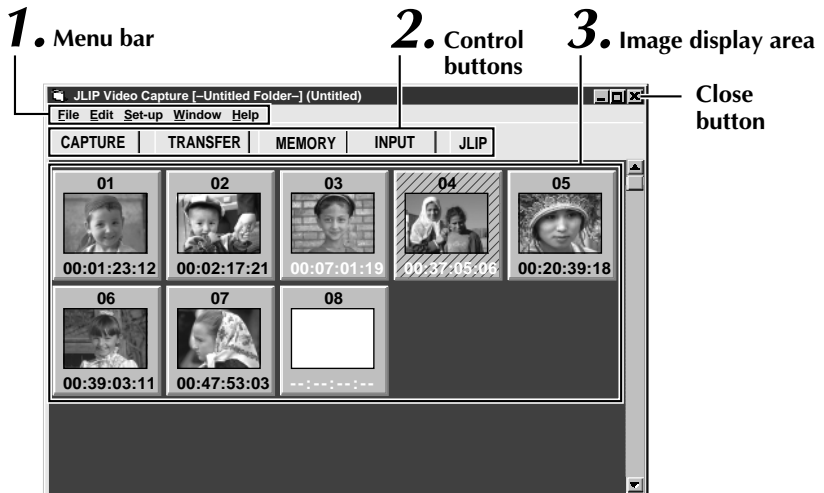

1 Menu bar

Displays function menus. See the next page for detailed information.

2 Control buttons

- **CAPTURE button** (☞ page 25)
Press to **CAPTURE** a desired image from an image source. When pressed, an index image appears under this button.
- **TRANSFER button** (☞ pages 27, 28)
The **TRANSFER** button is used to start Automatic Transfer. Automatic Transfer is divided into Program Capture and Interval Capture.
- **MEMORY/INPUT button**
Press to switch between the image stored in this unit and the image from the video source.
- **JLIP button** (☞ pages 41 through 65)
The JLIP Video Capture software and JLIP Player software cannot run simultaneously. When you want to run the JLIP Player software, press this button to disable the JLIP Video Capture software. You may then start the JLIP Player software. To resume using the JLIP Video Capture software, first select "Close Serial" from "File" on the JLIP Player Software's menu bar, then press the **JLIP** button.

3 Image display area

Each time you press the Capture button an image is captured by this device. An index image is transferred to the computer and displayed in the image area. Up to 99 images can be captured, with up to five images per line. Index images are provided to allow you to confirm that you have captured the images you want.

Index image: 80 x 60 pixels Full image: 640 x 480 pixels

Image display box

Click to select an image display box, and

- the border turns green
- Double-click an image display box, and Full image data will appear if it has already been transferred

Index numbers are automatically assigned

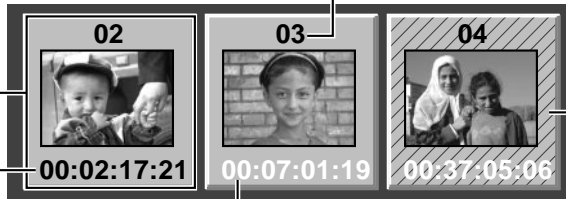

Counter display

Indicates the current tape position
eg. 00 : 12 : 17 : 21
Hour : Min : Sec : Frame

Colours of counter numerals

Black : Full image transferred
White : Full image not transferred
(only index image transferred)

Hatched like this when the counter time has been changed (see p. 30)

MENU BAR

All program functions can be selected from the menus in the menu bar. Click any item in the menu bar to open the corresponding pulldown menu. Then click the desired command in the pulldown menu. Some menu entries are invalid depending on the program status. Invalid commands appear lighter than valid commands.

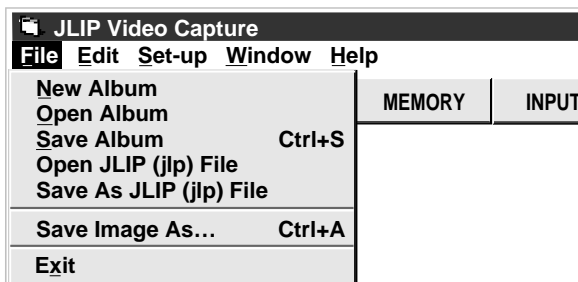

Each pulldown menu is configured as follows

File

New Album	Erases the current album and creates a new album.
Open Album	Opens an album (☞ p. 33).
Save Album Ctrl+S	Stores the open album (☞ p. 32).
Open JLIP (jlp) File	Opens a JLIP Player software file (☞ p. 34).
Save As JLIP (jlp) File	Converts to and saves as a JLIP Player software file (☞ p. 35).
Save Image As... Ctrl+A	Saves the image file to another folder or drive (☞ p. 33).
Exit	Closes the program (☞ p. 19).

Edit

Transfer the Index Image	• An index image of the image data in the Video Capture Docking Station memory is transferred to your computer and displayed in the selected image box (in the Step by Step capture mode).
Transfer the Full Image	• The video source unit scans the selected counter value and transfers the index image to your computer (in the automatic capture mode) (☞ p. 30).
Modify...	• A full image of the image data in the Video Capture Docking Station memory is transferred to your computer (in the Step by Step capture mode).
Delete Del	• The video source unit scans the selected counter value and transfers the full image (680 x 480 pixels) to your computer (☞ p. 30).
	Changes the scan timing in the automatic capture mode by changing the counter preset (☞ p. 30).
	Deletes the index image (☞ p. 31).

Set-up

Capture Mode	Two different modes available: Step by Step Capture and Automatic Capture (☞ p. 25, 26, 28).
Image Format	Selects image data format to be used in the transfer and capture mode (☞ p. 29).
Device Change	To initialize a connected unit or to change a connected unit (☞ p. 18).
Initialize	Initialize when changing a COM port or transfer rate (☞ p. 17).
ID Change	Changes the Video Capture unit's ID number (☞ p. 31).
Counter Reset	Resets the VCR's counter (☞ p. 30).

Window**Arrange Index**

— Arrange the index image after an index image has been deleted (☞ p. 31).

VCR

— The VCR operation window appears to allow the computer to control the VCR.

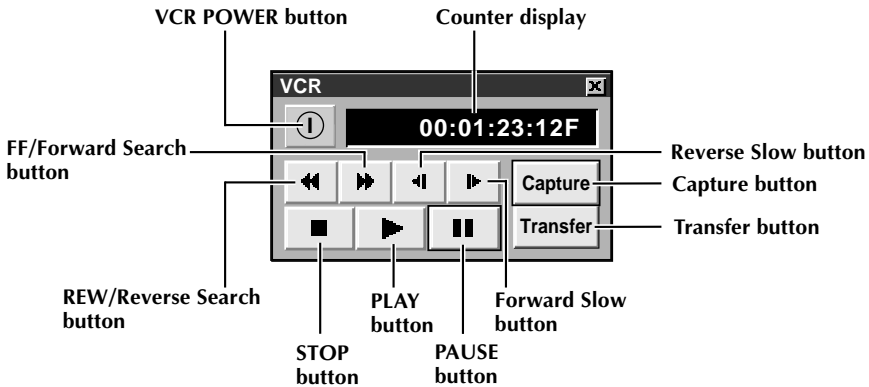
**[VCR] operation window****VCR models operable on the VCR Operation Window (compatible with JLIP)****Help****C**ontents**F1**

— Display Help menu

About JLIP Video Capture

— Display version information of this software.

NOTE : Counter reset

If you use a DV-format digital camcorder, counter information is represented by the time code written on the tape. Counter reset is not possible.

CAPTURING VIDEO IMAGES

There are three capture modes available: **Step by Step**, Program and Interval. The latter two modes are available only when connected to a JLIP compatible video source unit. **Step by Step** Capture mode must be used to capture images from a video source unit with no JLIP connector.

Image data flow

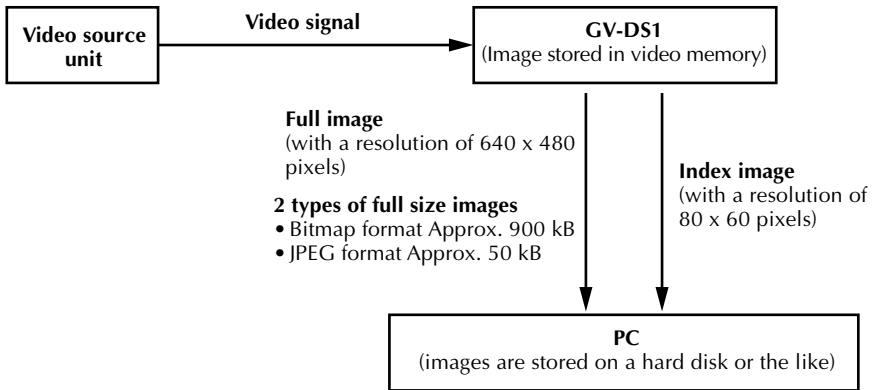

When storing images on a 2HD disk,

- One image saved in the bitmap data format can be stored on one disk.
- About 28 images saved in the JPEG format can be stored on one disk.

This is the case when using floppy disks formatted for 1.44 MB.

NOTE:

- The index image is displayed in the image display box.
- Each time the image display box is double-clicked, the full image (640 x 480 pixels) is displayed only after video data transfer is finished.

STEP BY STEP CAPTURE

Use the Step by Step Capture mode when you want to:

- Capture images from a video source unit with no JLIP connector
- Capture images from video units with video output connectors
- Capture a small number of images
- Confirm the images being captured.

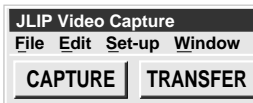
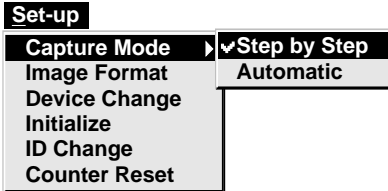

NOTE:

- Index images or Full images are transferred to the image display boxes bordered in green. Click and select the desired box(es).
- When transferring full image data using the Bitmap image format (*.bmp), the transfer takes a very long time, causing the video source unit to stop playback automatically.

Preparation

- Make sure all units are properly connected (☞ p. 12).
- Click "**Image Format**" in "**Set-up**" and select the desired format (☞ p. 29).

- 1 At the menu bar, click "**Set-up**" — "**Capture Mode**" — "**Step by Step**".
 - The Step by Step Mode is entered.
- 2 Click "**CAPTURE**" on the image you want to capture.
 - When a JLIP-compatible video source unit is connected, you may use the VCR Operation window. From the menu, click "**Window**" and select "**VCR**" to display the VCR Operation window (☞ p. 23).
 - When you press the **CAPTURE** button, the full image (640 x 480 pixels) is captured into the Video Capture module's memory. The index image (80 x 60 pixels) is simultaneously transferred to the computer.
- 3 Index image data is transferred to the computer.
 - The message "**No.1 index image being transferred**" appears during data transfer.
- 4 The message "**Transfer the full image ?**" appears. Click "**Yes**" and the full image (640 x 480 pixels) is transferred to the computer.
 - You cannot use the **TRANSFER** button in Step by Step Transfer mode.
- 5 The full image data is transferred to the computer.
 - The message "**No.1 full image being transferred**" appears during image transfer.
- 6 Repeat steps 2 through 5 as required.

AUTOMATIC CAPTURE

Automatic video capture is available only when a JLIIP-compatible video source unit is connected. There are two types of automatic capture: Program mode and Interval mode. You can save time in either mode because, once the initial settings have been stored or you have decided what pictures to capture, the subsequent capture process is carried out automatically.

PROGRAM CAPTURE

In the Program Capture mode, select the images you want to capture, and the JLIIP Video Capture Docking Station will automatically capture and transfer the images to your computer.

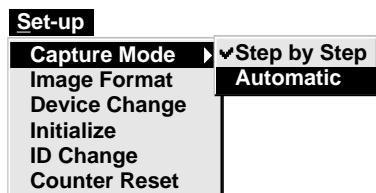

Preparation

- Make sure all units are properly connected (☞ p. 12).
- Insert a tape into the video source unit. Click "Image Format" from the "Set-up" menu and select "Field Picture" in the Capture Mode (☞ p. 29).

- 1 From the menu bar, click "Set-up" — "Capture Mode" — "Automatic".
 - The "Automatic Transfer" window appears.
- 2 Select image to be transferred.
 - When you select "Index Image", only the index image (80 x 60 pixels) is transferred to your computer.
 - When you select "Index & Full Image", both the index image (80 x 60 pixels) and full image (640 x 480 pixels) are transferred to the computer.
- 3 Select "Program Capture" and click "OK".

NOTE:

- Before transferring your images, make sure that enough space is available on your hard disk. For full image data space requirements, ☞ p. 24.
- When transferring full image data using the Bitmap image format (*.bmp), the transfer takes a very long time, causing the video source unit to stop playback automatically.



- 4 On the menu bar, click "**Window**" — "**VCR**" to call up the **VCR** Operation window.
 - 5 Operate the video source unit via the **VCR** Operation window and click the "Capture" button to capture the desired video image.
 - 6 Click the "**Capture**" button on the desired video image, and index image (80 x 60 pixels) is transferred to the computer.
 - The message "**No.1 index image being transferred**" appears during data transmission.
 - 7 Repeat steps 5 and 6 as necessary.
 - 8 Click "**Transfer**" button.
 - If you want to capture the full image (640 x 480 pixels) after capturing the "**Index Image**" in step 2, click "**Index & Full Image**" and then click the "**Transfer**" button.
1. The message "**Index No.1 being scanned**" appears while the video source unit is scanning the picture to be captured.
 2. The message "**No.1 index image being transferred**" appears and then "**No.1 full image being transferred.**" appears while the full image data is being transferred to the computer.
 3. The images captured in step 7 are scanned by the video source unit and automatically transferred to the computer.

INTERVAL CAPTURE

The Interval Capture mode is best suited for capturing images at set intervals from a video source unit with a JLIP connector.

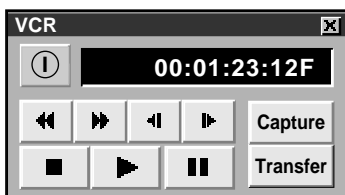
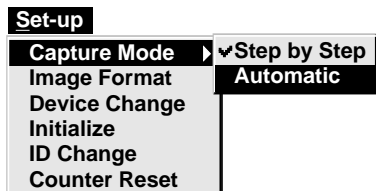

NOTE:

- Make sure that enough hard disk space is available on your computer before executing video transfer. For full image data space requirements, p. 24.
- Transfer of the index image and full image starts at the image box bordered in green. Click and select the desired image box.
- When transferring full image data using the Bitmap image format (*.bmp), the transfer takes a very long time, causing the video source unit to stop playback automatically.

Preparation

- Make sure all units are properly connected (p. 12).
- Insert a tape into the video source unit. In the "Set-up" menu, click "**Image Format**". Select "**Field Picture**" in the Capture Mode. (p. 29).

- 1 At the menu bar, click "**Set-up**" — "**Capture Mode**" — "**Automatic**".
 - The "Automatic Transfer" window appears.
- 2 Select the data to be transferred.
 - When you select "**Index Image**", only the index image (80 x 60 pixels) is transferred to your computer.
 - When you select "**Index & Full Image**", both index image (80 x 60 pixels) and full image (640 x 480 pixels) are transferred to the computer.
- 3 Select "**Interval Capture**".
- 4 Set the interval.
 - Select the time interval at which images are captured.
- 5 Set the number of images to be captured and click "OK".
 - From 1 up to 99
- 6 Click "**Window**" — "**VCR**" to call up the VCR Operation Window. Start video playback a few seconds prior to the point where you want image capturing to start.
- 7 Operate the video source unit via the VCR Operation window and click the "**Transfer**" button at the desired image to start the capture function.

1. The message "**No. 1 index image being transferred**" appears while the index image is being transferred to the computer.
2. When you select "**Index & Full Image**" in step 2, the message "**No. 1 full image being transferred**" appears while the full image is being transferred to the computer.
3. The message "**Index No. 2 being scanned**" appears while the video tape is fast-forwarded and played at the time intervals set in step 4 to scan the video data on the VCR.
 - The image selected when "**Transfer**" is clicked is captured and subsequent images are captured at the time interval specified by the counter value selected in step 4.
 - The video source unit enters the Pause mode when capture is complete.

SELECTING A PICTURE FORMAT

Under "Image Format", you can specify the full image format and the capture mode.

1 At the menu bar, click "Set-up" — "Image Format".
 • The "Image Format" window appears.

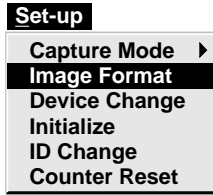

2 Select format.
 • There are two different settings available: "JPEG (*.jpg)" and "Bitmap (*.bmp)". Refer to "Picture Data Format" below for details.

3 Select capture mode.
 • There are two different settings available: "Frame Picture" and "Field Picture". Refer to "Capture Mode" below for details.

4 Click "OK".
 • This completes picture format setting.
 • This setting takes effect the next time you use the capture function.

TRANSFER DATA

The full image can be captured and transferred in two different formats.

Picture Data Format

- **JPEG (*.jpg)**
 - This is the default setting. If you do not set Picture Format, image data is captured in this format.
 - JPEG (Joint Photographic Expert Group) is a leading standard defining the compression and decompression of still color pictures.
 - The size of transferred image is smaller because the images are compressed. This results in a shorter transfer time.
- **Bitmap (*.bmp)**
 - Transfer time is longer when you use this format because there is no data compression. The benefit is that picture quality is maintained with no deterioration.
 - Bitmap is a data format representing characters and graphics with combinations of pixels. Full image resolution is 640 x 480 pixels with 16.77 million colors (24-bit color). Index image resolution is 80 x 60 pixels with 16.77 million colors (24-bit color).

Capture Mode

- **Frame Picture**
 - This is the default setting. If you do not set Picture Format, images are captured in this mode.
 - Since a frame consists of two overlapping 1/60 sec. images (one 1/30 sec. image forms a field), it is unstable when capturing fast-moving motion pictures.
- **Field Picture**
 - While a field contains only half the data of a frame — meaning that vertical resolution is half that of a frame — images captured from a fast-moving motion picture are more stable than when captured with "Frame Picture".

COUNTER VALUE CHANGE

If you want to replace a captured image with a different one, you can capture the new one by changing the counter value.

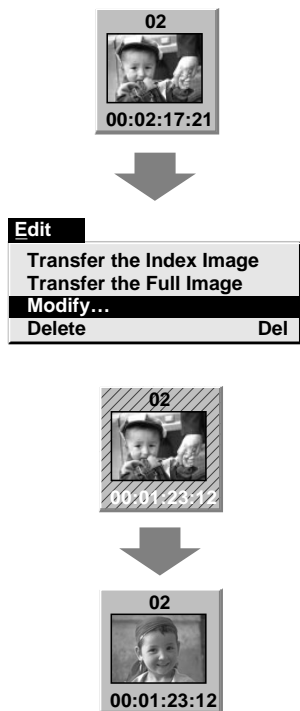

NOTE : Note that if the index image data is saved in step 4, the hatching pattern indicating the change will no longer appear the next time it is called up.

- 1** Click the image display box of the index number you want to change.
 - The box is bordered in green.
- 2** Open the menu bar and click "**Edit**" — "**Modify...**".
 - The "**Modify Capture Point**" window appears.
- 3** Enter a new counter value.
- 4** Click "**OK**".
 - The index image is surrounded by a hatching pattern indicating that a change is being made.
 - The counter value is changed to the value you just entered.
- 5** Open the menu bar and click "**Set-up**" — "**Capture Mode**" — "**Automatic**", then select "Program Capture" in the "Automatic Transfer" window and click "**OK**".
- 6** Play the tape on the video source unit and click "**Edit**" — "**Transfer the Index Image**".
 - Index image data at the counter setting is captured.
 - Be sure to complete steps 1 through 7. If they are not all followed, the index image and the full image will be different as the full image data will not have been changed in step 6.
- 7** Click "**Edit**" — "**Transfer the Full Image**".
 - Full image data at the counter setting is transferred.

COUNTER RESET

You can change the counter setting on connected video source units (VHS, VHS-C).

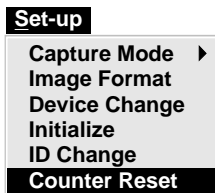

- 1** Open the menu bar and click "**Set-up**" — "**Counter Reset**".
 - The VCR's counter is reset.
 - The counters of DV-format digital camcorders cannot be reset.

DELETE INDEX IMAGE AND FULL IMAGE

You can delete any captured picture. Both index image (80 x 60 pixels) and full image (640 x 480 pixels) are deleted.

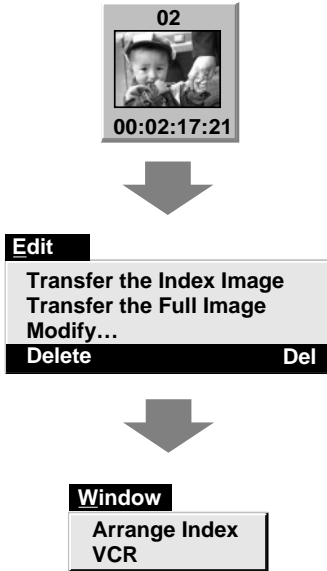

- 1 Click the image display box you want to delete.
 - The box is bordered in green.
- 2 Open the menu bar and click "**Edit**" — "**Delete**".
 - This deletes the selected image data.
- 3 Then click "**Window**" — "**Arrange Index**".
 - This removes the deleted index image's space and renumbers the remaining index display box. You can still run the program without re-arranging the index.

CHANGE ID

You can change the Video Capture Unit's ID number.

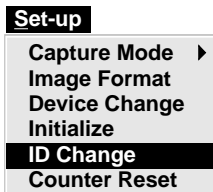

- 1 Open the menu bar and click "**Set-up**" — "**ID Change**".
 - **ID Change** window appears.
- 2 Enter a new ID number.
- 3 Click "**OK**".
 - This completes the ID number change.
- 4 Open the menu bar and click "**Set-up**" — "**Initialize**".
 - The "JLIP Initialization" window appears.
 - Start JLIP initialization (☞ p. 17, 18).

CREATE NEW FOLDER

Creating a new folder (directory) is a good idea when capturing an image from another video tape.

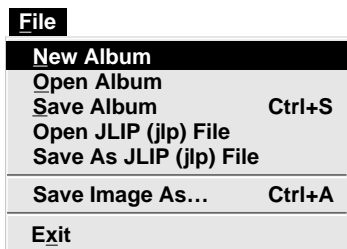

- 1 Open the menu bar and click "**File**" — "**New Album**".
 - The image display area is refreshed.
 - If the index image data on screen is not saved, you will be asked whether to save or not.

SAVING

Select when storing the contents displayed in the image display area (page 21).

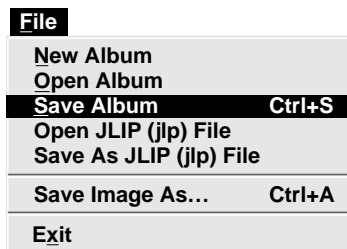

- 1 Open the menu bar and click "**File**" — "**Save Album**".
 - The "**Save Album**" window appears.
- 2 Type the folder name and title.
 - You can save without entering any title.
- 3 Click "**OK**".
 - The file is saved.

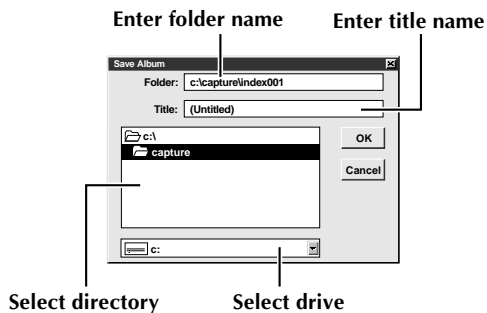

OPEN INDEX

File	
New Album	
Open Album	
Save Album	Ctrl+S
Open JLIIP (jlp) File	
Save As JLIIP (jlp) File	
Save Image As...	Ctrl+A
Exit	

- 1 Open the menu bar and click "File" — "Open Album".
 - The "Open Album" window appears.
- 2 Select the name of the folder (directory).
- 3 Click "OK".

SAVE THE FULL IMAGE DATA

You can save a file under another name or in another folder so that you can edit it without losing the original.

By processing the captured images with commercially available image editing software, you can create your own unique and highly personal illustrations and graphics for incorporation into everything from postcards to newsletters and Internet homepages.

File	
New Album	
Open Album	
Save Album	Ctrl+S
Open JLIIP (jlp) File	
Save As JLIIP (jlp) File	
Save Image As...	Ctrl+A
Exit	

- 1 Click the image display box of the Index No. to be saved.
 - The image display box is framed in green.
- 2 Click "File" — "Save Image As..." on the menu bar.
 - The "Save Image As... (Index No. □)" window appears.
- 3 Click the name of the desired folder (directory) in the Select Directory box and enter the file name.
 - When saving the data to floppy disk, enter the drive name as well.
- 4 Click "OK".

NOTE:

- It is not possible to change the image format when saving the full image data (☞ p. 29).
- If the full image data has not been transferred to the computer, it is not possible to save it. First transfer the full image data, then save it.

USING JLIP PLAYER SOFTWARE DATA

The GV-DS1 Video Capture Docking Station can capture JLIP Player software data at an edit-in point corresponding to a preset counter number.

File	
New Album	
Open Album	
Save Album	Ctrl+S
Open JLIP (jlp) File	
Save As JLIP (jlp) File	
Save Image As...	Ctrl+A
Exit	

Preparation

- Make sure all units are properly connected (☞ p. 12).
- Insert the tape program edited with the Player Software into the video source unit.
- If the data is stored on a floppy disk, load disk into the floppy disk drive.

- 1 Open the menu bar and click "**File**" — "**Open JLIP (jlp) File**".
 - The "**Open JLIP(jlp) File**" window is displayed.
- 2 Double-click the name of the desired folder (directory) in the Select Directory box.
 - If the data is stored on a floppy disk, enter the drive name.
- 3 Click on the file name to select it.
- 4 Click "**OK**".
 - The computer monitor displays Scene No., counter number at Edit-in Point, and a blank image box.
- 5 Open the menu bar and click "**Set-up**" — "**Capture Mode**" — "**Automatic**".
- 6 Select the data you want to transfer and "**Program Capture**" and click "**OK**".
- 7 Click the "**TRANSFER**" button.
 - The image data scanned by the video source unit is automatically transferred to your computer.

HOW TO STORE JLIP PLAYER DATA

Data from this unit can be converted to JLIP Player software files.

If index image data is saved as a JLIP Player software file, the file can be printed with the optional GV-PT1/GV-PT2 Video Printer.

Refer to the instruction manual for details.

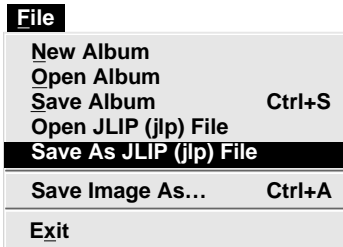

Preparation

- Make sure all units are properly connected (☞ p. 12).
- Insert a video tape into the video source unit.
- If you want to store the data on a floppy disk, load a data disk into the floppy disk drive, create a directory and sub-directory on the data disk (☞ p. 54).

- 1 Open the menu bar and click "**File**" — "**Save As JLIP (jlp) File**".
 - The "**Save As JLIP (jlp) File**" window is displayed.
- 2 Enter the folder name (directory) and file name.
 - If you want to store the data on a floppy disk, enter the drive name.
- 3 Click "**OK**".
 - The data converted to a JLIP Player software file is stored on the floppy disk in the selected drive.
 - JLIP Player software files can be used for video program editing or printed with the video printer. (☞ p. 58, 60)

NOTE : When stored data is opened with the JLIP Player software, the edit-in and edit-out points have the same counter value. When you want to perform program editing, change the counter number at the edit-out point in the JLIP Player software's "Modify Edit Points".

NOTE : External noise or disturbance may interfere with the microprocessors built into the GV-DS1 JLIP Video Capture Docking Station. If this happens, turn the power off and then turn it on again.

Problem	Cause	Page
No effect when clicking the Input Select/Memory buttons.	<ul style="list-style-type: none"> ● The windows do not change during transfer or compression of index image/full image data. ● The video is displayed on the LCD screen of the attached GR-DVM1. It is not possible to check the images on the computer. 	—
The video equipment image is not displayed on the connected TV.	<ul style="list-style-type: none"> ● When video equipment is connected to the CAPTURE EXT IN/PRINTER connector, its video is displayed on the LCD screen of the GR-DVM1. 	—
The video unit does not operate when "Window" — "VCR" in the menu bar and "VCR" in the "VCR" operation window are clicked.	<ul style="list-style-type: none"> ● The counter display in the "VCR" operation window turns blue. ● Is your video unit compatible with JLIP ? Only JLIP-compatible units can be operated. If you are using a JLIP-compatible unit and it still won't work, check to make sure that it is correctly connected. ● Is the video unit selected in "Select Unit" ? Select correctly. ● Initialize JLIP. ● Make sure the video unit is turned on. 	23 11 – 13 19 18
Reverse Slow Play and Forward Slow Play not available in "VCR" operation window.	<ul style="list-style-type: none"> ● These are available only when the video unit has a Slow Play function. 	—
The "VCR" operation window display shows a different operation from what the video unit is actually doing.	<ul style="list-style-type: none"> ● Slow Play in the VCR operation window automatically switches to Play after approximately 20 seconds. ● In some cases, the video unit may continue slow-motion playback even when the "VCR" operation window changes from Slow Play to Play. Check your video unit's instruction manual for details. 	23
On-screen display of video unit is stored in memory.	<ul style="list-style-type: none"> ● If your video unit has an onscreen display, turn it off. 	—
Counter display appears in the image display box even when there is no tape in the video unit.	<ul style="list-style-type: none"> ● When capture video data from a powered-on video unit with no tape loaded, a counter display may appear in the image display box. Images corresponding to the displayed counter number can no longer be captured. 	—

Problem	Cause	Page
Cannot capture video data with the desired counter number.	<ul style="list-style-type: none"> ● There may be a slight difference between the counter of the video image that you want to capture and the Index image data/ Full image data captured in the computer. This is not a malfunction. 	25 – 28
Counter cannot be reset.	<ul style="list-style-type: none"> ● Counter reset is not available with digital camcorders. 	30
Program capture suddenly stops.	<ul style="list-style-type: none"> ● When you start program capture at the beginning of the tape, the video unit stops playback, ending program capture. Start video capture about 20 seconds after the point where the recording begins. 	26
After finishing video capture, the video file remains in the JCPT folder (where the program run file is contained).	<ul style="list-style-type: none"> ● If you want to erase the file because of limited hard disk space, start the program once then close it. The video remaining in the JCPT folder will be cleared. 	—
JLIP initialization not possible.	<ul style="list-style-type: none"> ● Make sure that the IRQ (Interrupt ReQuest) is not being used by another device. ● COM port selection is wrong. Confirm the COM port number and execute JLIP initialization again. 	18
With Video capture/ Transfer done in Automatic Transfer mode, the captured image looks like two pictures laid one upon another.	<ul style="list-style-type: none"> ● In this case, video capture is not possible using the "Frame Picture" setting. Change the setting to "Field Picture" and try video capture again. 	29

The monitor displays of the application software illustrated in this manual may differ from those you are actually viewing depending on the operating environment of your computer.

Operation will be significantly slower when used in an environment other than that recommended (page 14).

While basic VCR operations such as playback and fast-forward are available, a "transmission error" may occur in some models during video transfer. In this case, start the software again, and turn the power of the Video Capture Docking Station off and on.

Message	<ul style="list-style-type: none"> ● Appears when: ■ Action: 	Page
Execute after playing back the VCR.	<ul style="list-style-type: none"> ● Video unit is not in Play mode during Interval Capture. ■ Click "OK", set the video unit to Play and click "Transfer" again. 	28
Not enough disk space is available.	<ul style="list-style-type: none"> ● Remaining disk space is under 1 MB. ■ Click "OK", check disk space and select a drive with space available with Store As. 	—
Communication error.	<ul style="list-style-type: none"> ● If operation stops after this message appears, turn the Capture Docking Station off and then on again. Images stored in memory will be lost. ■ Do not use any other application while JLIP Video Capture and JLIP player are running as it may interfere with communication. Do not click and move the mouse during data transfer. ● If your computer's energy saver, battery voltage indication or screen saver is engaged, the image data transmission may be interrupted. ■ Disengage these functions. Refer to your computer's instructions manual on details. 	—
Check the capture device.	<ul style="list-style-type: none"> ● If operation stops after this message appears, turn the Capture Docking Station off and then on again. Images stored in memory will be lost. 	—

JLIP PLAYER SOFTWARE SECTION

- The Readme.TXT file provides additional information for setup and information that is not included in the instruction manual. Please read the file before installing the provided software program.
- You can find the latest information (in English) on the provided software program at our world wide web server at <http://www.jvc-victor.co.jp/>

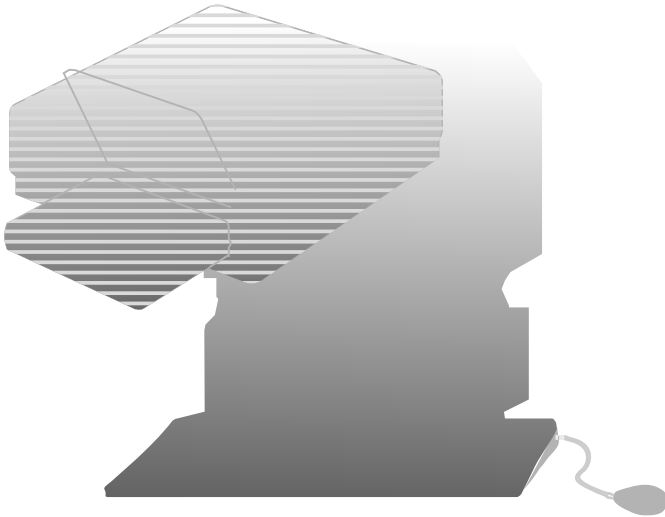

WHEN CONNECTING TO A VIDEO SOURCE UNIT WITH JLIP CONNECTOR OR TO A VIDEO PRINTER

- Be sure to turn off the power of all connected units before making any connections.
- When connecting the provided cable, be sure to connect the plug with the Core Filter to the Video Capture Docking Station.

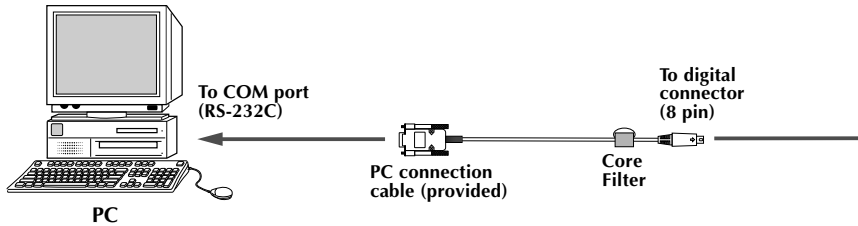

When connected with the Video Printer

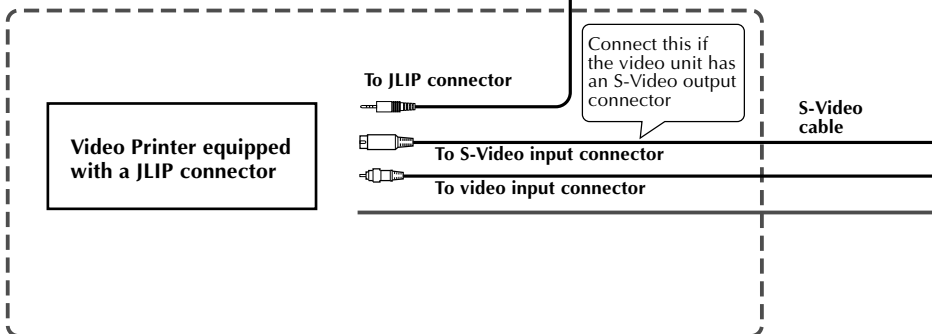

If you edit using a non-JVC VCR...

It is possible to use the remote control unit provided with the GR-DVM1. Also refer to the GR-DVM1's instructions on connection and operation with your brand of VCR.

NOTE:

Some VCR brands or models cannot be operated.

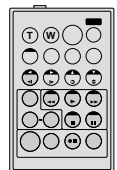

RM-V708U

■ When using the Video Capture Docking Station, use the AA-V80U AC Adapter/Charger (optional or provided with the camcorder).

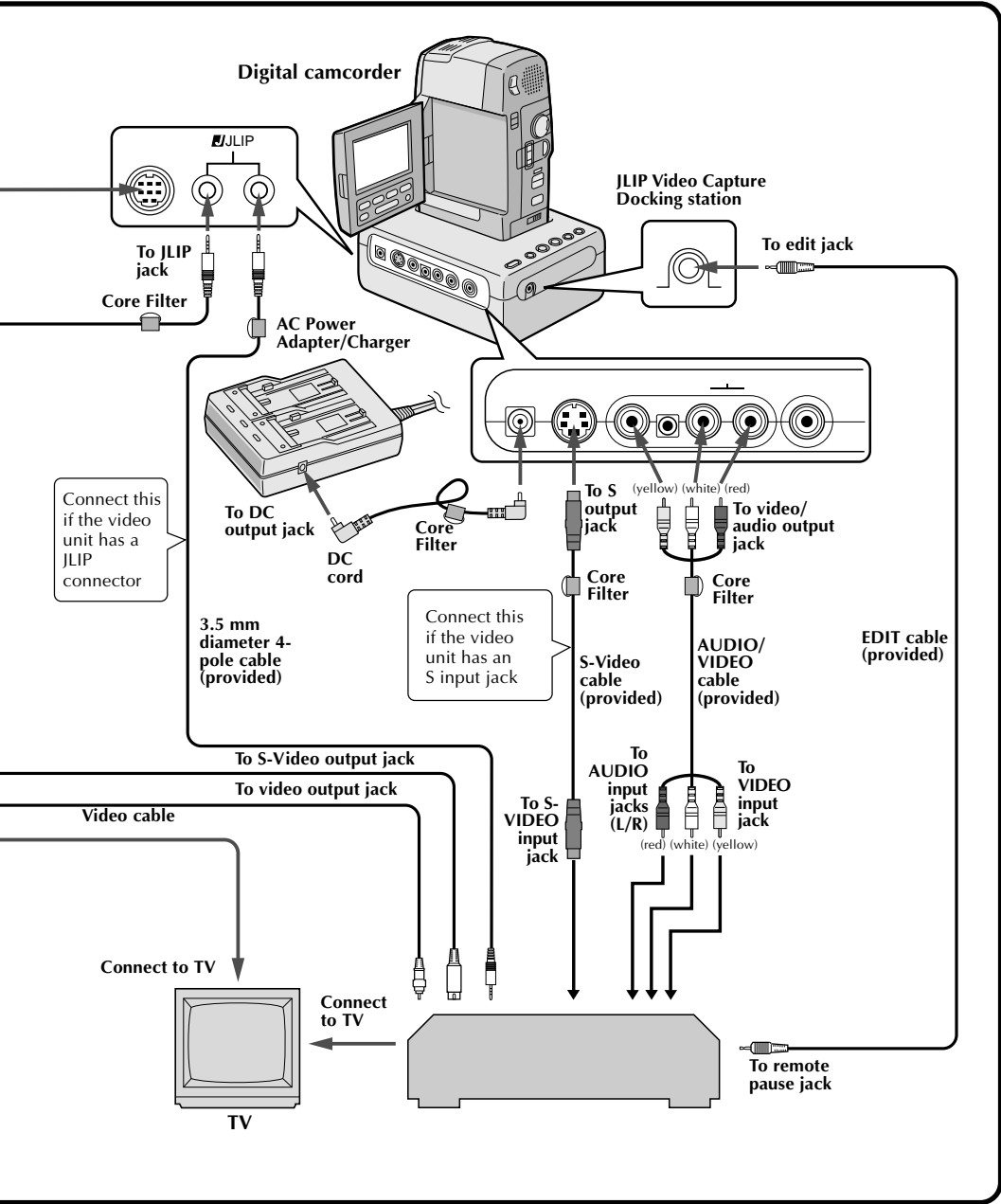

What is JLIP ?

JLIP* stands for Joint Level Interface Protocol, a new communication protocol which allows AV units equipped with a JLIP terminal to be controlled by a personal computer.

* **JLIP** is a registered trademark of JVC.

Operating Environment

- Personal computer with Microsoft® Windows® 3.1 or Windows® 95
- CPU Intel DX4™ or higher processor
- Minimum RAM requirement: more than 8 MB
- Available Hard Disk space of at least 8 MB
- Colour display capable of at least 640 x 480 pixels, 256 colours
Recommended 1024 x 768, 16.77 Mil colours
- 1 free serial transmission port, compatible with 9600 bps transmission rate, connectable to RS-232C with 9 pin serial connector.
Recommended compatible with UART 16550A
- Mouse (Windows® compatible)
- CD-ROM drive

Note : An optional 9 pin serial conversion adapter is required for computers using serial communication port other than standard 9 pin.

* Microsoft® and Windows® are either registered trademarks or trademarks of Microsoft Corporation in the United States and/or other countries.

* Other product and company names included in this instruction manual are trademarks and/or registered trademarks of their respective holders.

Devices to connect to the VIDEO CAPTURE BOX

- Camcorder equipped with JLIP connector
- Video printer equipped with JLIP connector

WINDOWS® 95

Refer to the Windows® 95 manual or your computer's manual for details on basic Windows® 95 operating procedures.

Installation Procedure

*To start the setup program...

- 1** Launch Windows® 95
 - Close any other applications that are running.
- 2** Insert the "VIDEO MOVIE PLAYER" CD-ROM into the CD-ROM drive.
- 3** Choose "Run" from the "Start" on the taskbar.
- 4** If the "VIDEO MOVIE PLAYER" CD-ROM is in Drive D, type "D:\VMPE\SETUP" in the box to the right of "Open". If the disk is in Drive E, type "E:\VMPE\SETUP".
 - Click "OK".
 - Once the setup program is running, simply follow the instructions displayed on-screen.
 - When setup is complete, the "MOVIE PLAYER" icon appears on the screen.
 - "MOVIE PLAYER Setup was completed successfully." appears.
- 5** Click "OK" to complete installation.

WINDOWS® 3.1

Refer to the Windows® 3.1 manual of or your computer manual for details on basic Windows® 3.1 operating procedures.

Installation Procedure

*To start the setup program...

- 1** Launch Windows® 3.1
 - Close any other applications that are running.
- 2** Insert the "VIDEO MOVIE PLAYER" CD-ROM into the CD-ROM drive.
- 3** Choose "Run" from "File" in the "Program Manager".
- 4** If the "VIDEO MOVIE PLAYER" CD-ROM is in Drive D, type "D:\VMPE\SETUP" in the box to the right of "Open". If the disk is in Drive E, type "E:\VMPE\SETUP".
 - Click "OK".
 - Once the setup program is running, simply follow the instructions displayed on-screen.
 - When setup is complete, the "MOVIE PLAYER" icon appears on the screen.
 - "MOVIE PLAYER Setup was completed successfully." appears.
- 5** Click "OK" to complete installation.

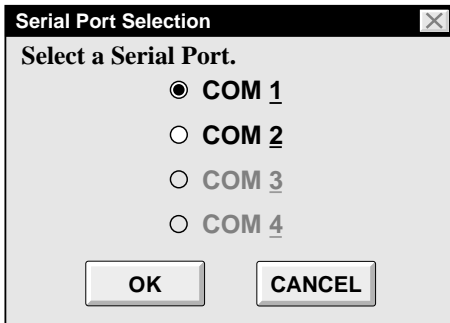
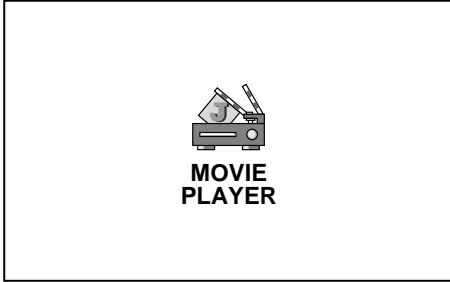

Starting JLIP Player Software

1 PREPARE DEVICE(S)

Turn the device(s) on and set the camcorder's Power Dial to "PLAY".

2 ACCESS MOVIE PLAYER

Double-click the MOVIE PLAYER icon and the Serial Port Selection dialog box appears.

3 SELECT SERIAL PORT

Select the port number of the connector you are using to connect the computer to the Video Capture Docking Station.

- If the connector number is A, B... A corresponds to 1.
- Click "OK".
- If the connection is correct, the Device Selection dialog box appears.

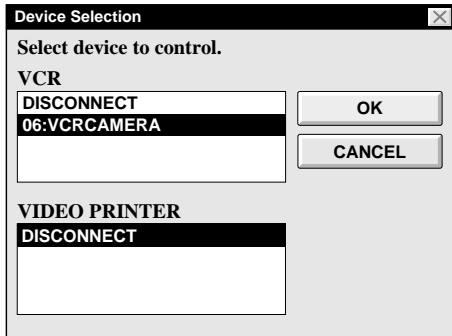

- An error message "**No devices detected to connect. Power ON all devices in system.**" appears . . .

... when a wrong port number is selected.

... when the connection is wrong.

... when the device's ID number is already in use.

... when the device's power is not turned on.

Check the Serial Port selection, too. To return to step 1, check the connection and the device's power and try again.

- When all serial COM ports are occupied by other applications the error message "Error--This application will close. Check devices--Confirm that power is ON." appears. Free a serial COM port to start up JLIP Player Software.

4 SELECT DEVICE(S)

Click on the name of the device you wish to control. Clicking "OK" brings up the MOVIE PLAYER window.

- It is possible to select a second device of a different type simultaneously, but it is impossible to select two devices of the same type simultaneously.

48 MOVIE PLAYER WINDOW BUTTONS AND DISPLAYS

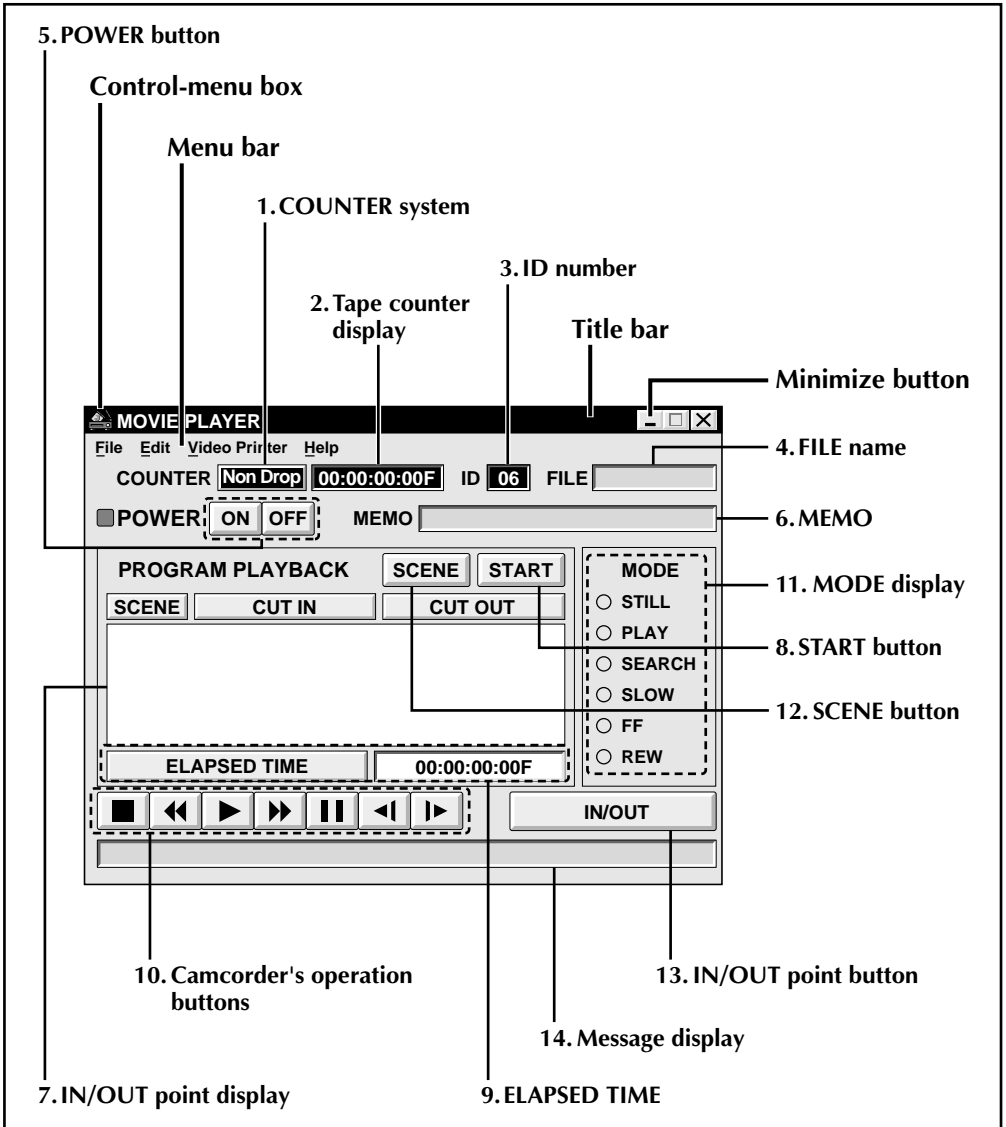

Drop Frame System**

This system automatically adjusts the gap between the time code* (1 second = 30 frames) and NTSC signal whose frame period is 29.97 seconds. When minutes increase, frames 00 and 01 frames are dropped and time count starts with frame 02. If minutes are multiples of 10 (0, 10, 20 and 30, etc.), time count starts with frame 00.

* Time data for hours, minutes, seconds and frames (1 second = approx. 30 frames) are recorded on the tape the moment that shooting starts.

1. COUNTER system

- GR-DVM1 uses the Drop Frame System**.

2. Tape counter display

- Displays actual tape position.

ex.

00: 01: 45: 10F
(Hours : Minutes : Seconds : Frames)

3. ID number

- Displays the selected device's ID number.

4. FILE name

- Displays file name after saving the program under a new name.

ex. travel

5. POWER button

- Turns the device on and off.
- If power is not supplied to the camcorder beforehand, you can not turn the camcorder on and off by clicking this button.
- Some camcorders cannot be turned on and off by clicking this button.

6. MEMO

- If you wish to add some comment to the file, you can input it.

ex. Europe Tour

7. IN/OUT point display

- You can set up to 99 in/out points per file.

8. START button

- Starts editing. Scenes are recorded in scene's numerical order. After starting editing, this button changes to STOP button.

9. ELAPSED TIME

- Displays the total elapsed time of all the programmed scenes.

10. Camcorder's operation buttons

- Operate the camcorder.



Stop button



REW/REW Search button



Play button



FF/FF Search button



Pause button



Reverse Slow button



Forward Slow button

- To start Reverse/Forward Slow-motion Search, first click the Pause button and then the Reverse/Forward Slow button.
- Functions your camcorder does not have cannot be performed by the above buttons.
- Click "File" — "Open VCR Control Window" on menubar to call up the "VCR Control" window. You can control the video source unit from this window.

11. MODE display

- Displays the camcorder's mode when operating the above buttons.

12. SCENE button

- Plays back only one programmed scene so that you can preview it.
- Operates only the camcorder.

13. IN/OUT point button

- Registers the cut-in and cut-out points of the scene you want to dub.

14. Message display

- Displays the connected device mode, etc.

To exit from the MOVIE PLAYER window, choose "Exit" from the "File" menu.

NOTE:

If you need the "MOVIE PLAYER HELP" window, choose "Contents" from the "Help" menu.

Operating camcorder

1 PREPARE CAMCORDER

Set the camcorder's Power Dial to "PLAY" and insert a recorded tape into the camcorder.

2 PLAYBACK ON TV MONITOR

Click **▶**. The PLAY lamp lights in the MODE display.

- Playback picture appears on the TV monitor.
- To confirm other operations, click other buttons.

Setting in/out points

1 PLAYBACK ON TV MONITOR

Click **▶**. Playback picture appears on the TV monitor.

2 SET CUT IN/OUT POINTS

Select "Set Function" from the "Edit" menu in the Movie Player window and select "Edit Tape".

To set CUT IN/OUT points, click the IN/OUT button at the start and end of the scene you want to dub.

- Set CUT IN/OUT points so that the CUT OUT point's value is larger than the CUT IN point's.
- A scene with no CUT OUT point will disable program playback and dubbing.
- If you set CUT IN point at the beginning of the tape or if you set CUT OUT point at the end of the tape, editing may not function properly. Change previously registered CUT IN/OUT points slightly and try setting them again.
- When connecting to a VHS-C camcorder, rewind the tape to its beginning and press COUNTER RESET on the camcorder.
- The counters of DV-format digital camcorders cannot be reset.

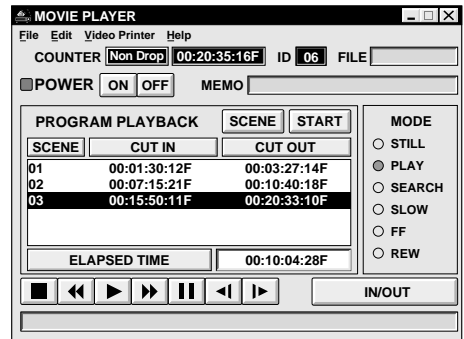

Playing back one programmed scene

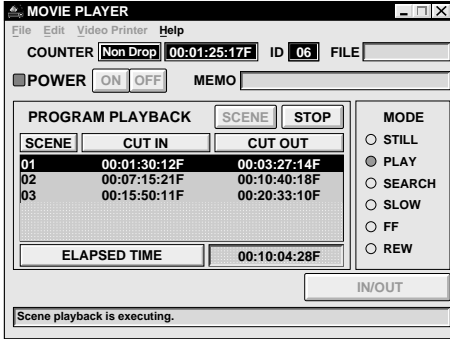

1 SELECT SCENE

Click on the line where the CUT IN/OUT points you want to preview are displayed and that line will be highlighted.

2 START PLAYBACK

Click "SCENE".

- The camcorder searches the scene by going to a point prior to the CUT IN point and starts playback at the CUT IN point. Playback stops after the CUT OUT point is passed.

Playing back all programmed scenes

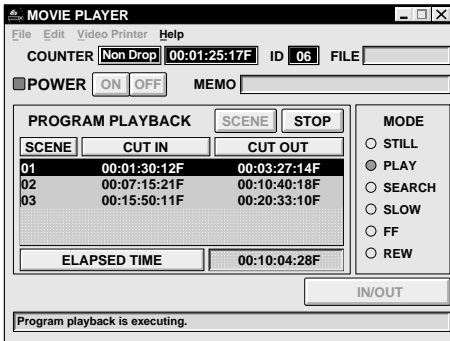

1 START PLAYBACK

To confirm all programmed scenes, click "START".

- The camcorder plays back scenes in numerical order and stops immediately after the last scene's CUT OUT point.
- Only the camcorder moves.

NOTES:

- During playback of programmed scenes, do no operation other than pressing "STOP". If other operations are done, a malfunction may occur.
- If "SCENE" or "START" is clicked at the end of tape, the camcorder will not function properly.
- If the source tape has a blank portion, scenes will not be edited properly.

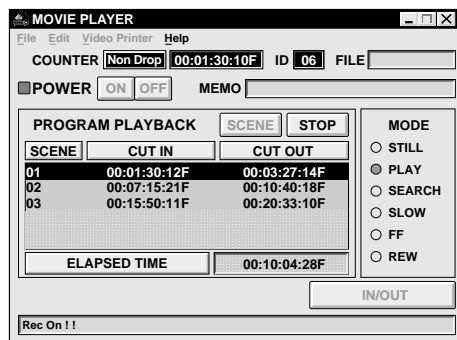

Dubbing

You can record all programmed scenes onto the tape in the recording deck. Dubbing is possible only when the GR-DVM1 is connected.

1 PREPARE NEW TAPE

Make sure the erase protection tab on the tape is present. Then insert it into the recording deck and set the recording deck to the Record-Pause mode.

2 START EDITING

Click "START" on the MOVIE PLAYER window.

When editing stops, the camcorder enters the Stop mode and the recording deck enters the Record-Pause mode.

- During dubbing, do no operation other than pressing "STOP". If other operations are done, a malfunction may occur.

3 STOP EDITING

Stop the recording deck.

NOTES:

- Also refer to the camcorder's instruction manual on dubbing.
- There may be small margin between the CUT IN/OUT points you input and the dubbed scenes' ones.
- Dubbing is impossible if the J/LIP connector of the camcorder also serves as an Edit jack.

Saving the program list on hard disk

It is possible to save all programmed scene information as a file in the computer.

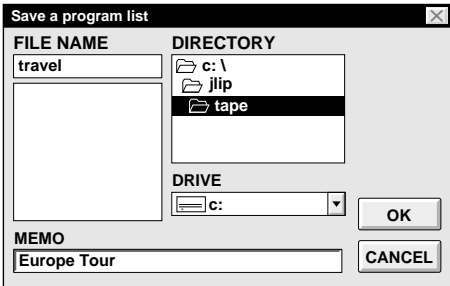
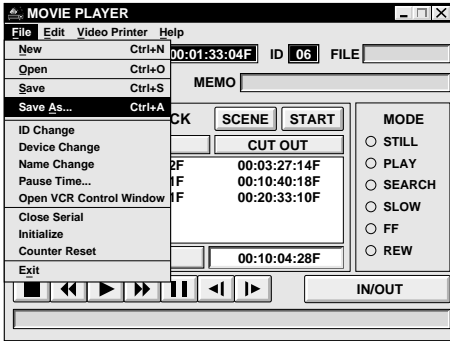

1 START SAVING

Select "Save As" from "File" on the MOVIE PLAYER window.

- The "Save a program list" dialog box appears.

2 ENTER FILE NAME

Input a file name (up to 8 characters) in the "FILE NAME" field.

- The extension is jlp. ex.: travel.jlp
- You can also input a comment (up to 30 characters) in the "MEMO" field.

3 SAVE FILE

Click "OK" and the file will be saved on the hard disk which is in use.

Saving the program list on a floppy disk

Prepare floppy disk by creating a directory named "JLIP" and subdirectory named "tape" beforehand.

1 SELECT FLOPPY DISK DRIVE

Click ▼ in "DRIVE".

2 OPEN SUBDIRECTORY

Click "tape" in the "DIRECTORY".

3 SAVE FILE

Click "OK".

NOTE:

If the MOVIE PLAYER window is closed before saving the file, the file will not be saved. So, save the file before closing the MOVIE PLAYER window if you wish to keep it.

Opening a saved file

1 LOOK FOR FILE NAMES

Click "Open" from "File" on the MOVIE PLAYER window.

- The "Open a program list" dialog box appears.

2 SELECT FILE NAME

Saved file names appear in the "FILE NAME" field. Click on the file name you want and it appears in the field above.

3 DETERMINE FILE NAME

Click "OK" and the file will be read.

- The MOVIE PLAYER window returns.

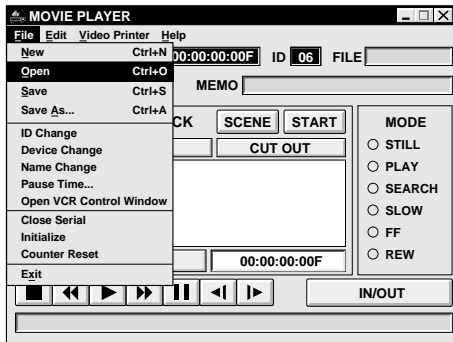

Opening a file saved on floppy disk

1 INSERT FLOPPY DISK INTO DRIVE

2 SELECT DRIVE NUMBER

Click ▼ in "DRIVE".

3 LOOK FOR FILE NAMES

Open "tape" in the directory.

4 SELECT FILE NAME

Follow steps 2 and 3 in "Opening a saved file" on the left.

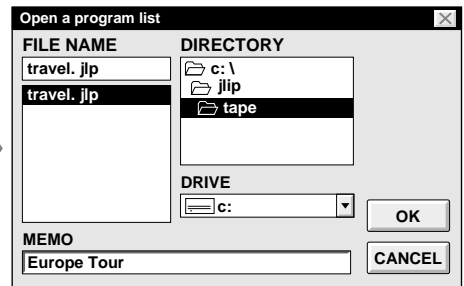

Correcting and cutting the programmed counter data

Correcting the program counter data

1 DESIGNATE SCENE

Double-click on the scene you want to modify.

OR...

Click on the scene you want to modify and choose "Modify" from "Edit".

- The "Modify Edit Points" dialog box appears (pg. 55).

2 ENTER NEW DATA

Click on the part to be corrected and input a new value there. To correct the data, click on "OK".

Cutting the counter data being set up

1 DESIGNATE SCENE

Click on the scene you want to cut.

2 CUT SCENE

Choose "Cut" from "Edit".

- The message "Scene No. □ will be deleted." appears.

To cut the scene, click on "OK".

Cutting all programmed scenes

1 CUT SCENE

Choose "All Clear" from "Edit". The message "OK to delete all programmed scenes ?" appears. To cut, click on "OK".

Copying a programmed scene and transferring it to an other position

- 1 DESIGNATE SCENE TO BE COPIED**
Click on the scene you want to copy.
- 2 STORE DESIGNATED SCENE IN MEMORY**
Choose "Copy" from "Edit".
- 3 DESIGNATE POSITION**
Click on the scene number which is above the position to which the copied scene is to be transferred.
- 4 TRANSFER COPIED SCENE**
Choose "Paste" from "Edit".

Transferring the programmed scene to an other position

- 1 DESIGNATE SCENE TO BE TRANSFERRED**
Click on the scene you want to transfer and choose "Cut" from "Edit".
•The message "Scene No. will be deleted." appears.
To cut, click on "OK".
- 2 DESIGNATE POSITION**
Click on the scene number which is above the position to which the scene is to be transferred.
- 3 TRANSFER CUT SCENE**
Choose "Paste" from "Edit".

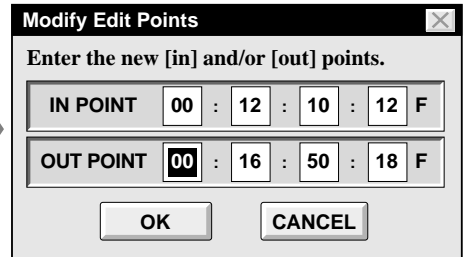
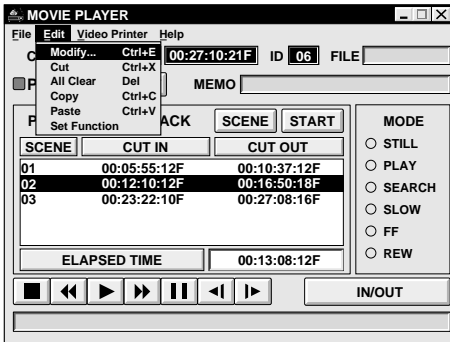

Overwriting the file

Saving any previously saved program using the same name. Overwrite erases the previously saved data for that file.

- 1 OVERWRITE FILE**
After opening a file and modifying counter data (pg. 54), choose "Save" from "File" on the MOVIE PLAYER window and click on "OK".
•The message "This file already exists. Do you want to overwrite it ?" appears.
To overwrite the file, click on "OK".

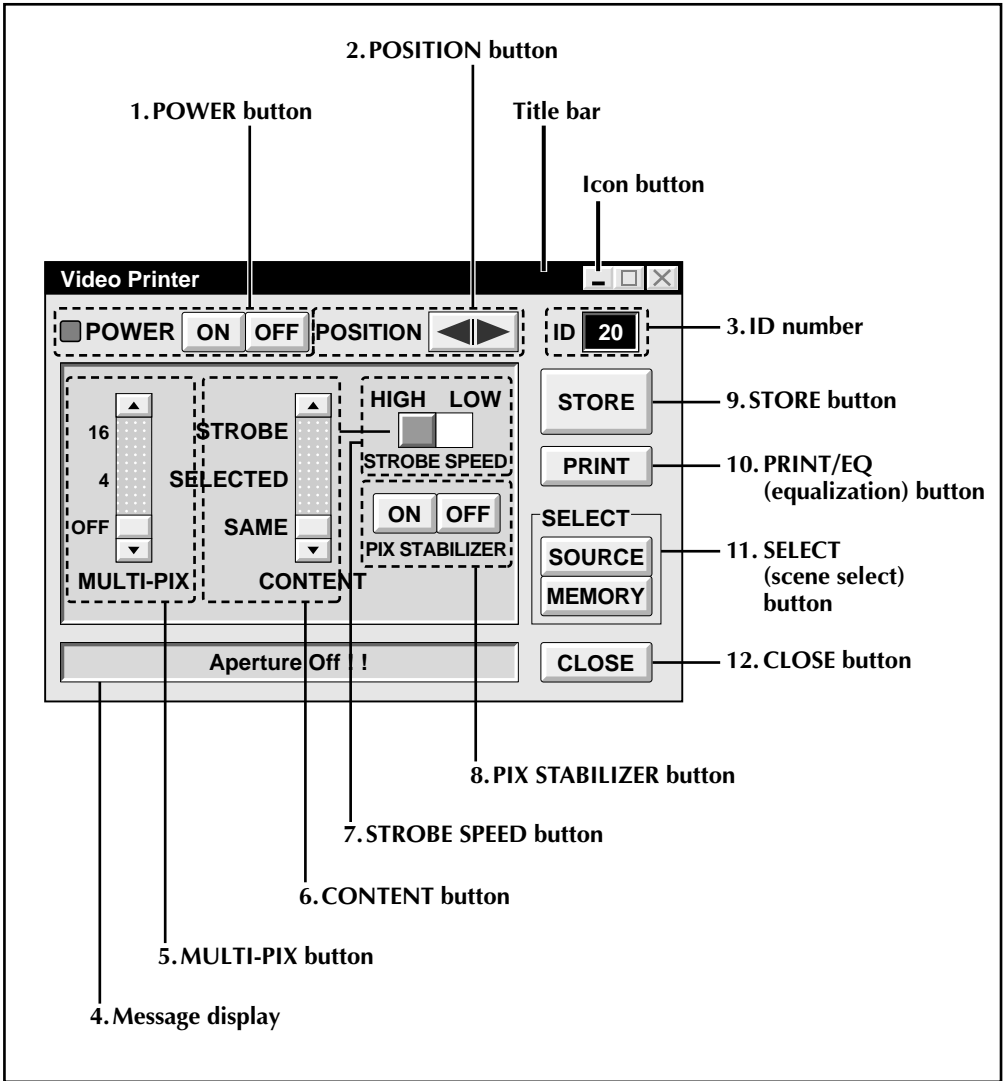

1. POWER button

- Turns the device on and off.

2. POSITION button

- Selects the position to store a scene in memory for Multi-Print.

3. ID number

- Displays the selected device's ID number.

4. Message display

- Displays the operating mode of the selected device.

5. MULTI-PIX button

- Select by clicking (▲/▼) button.

OFF : Single print

4 : 4 shots on one sheet

16 : 16 shots on one sheet

6. CONTENT button

- Select by clicking (▲/▼) button.

STROBE : Stores the selected number of images at short intervals, and prints them all on one sheet.

SELECTED : Prints 4 or 16 selected scenes on one sheet.

SAME : Prints the same scene 4 or 16 times on one sheet.

7. STROBE SPEED button

- Effective when "STROBE" is selected from "CONTENT".

HIGH : When printing in the Strobe Print mode, the GV-PT1 stores scenes at intervals of approximately 1/4 second and the GV-PT2 at intervals of approximately 1/15 second.

LOW : When printing in the Strobe Print mode, scenes are stored at intervals of approximately 1/2 second.

8. PIX STABILIZER button

ON : If the scene you want to print is jittery, select "ON" to stabilize it.

OFF : Usually set to "OFF".

9. STORE button

- Stores scenes and titles you want to print in the video printer's memory.

10. PRINT/EQ (equalization) button

- Displays either "PRINT" or "EQ" on screen depending on the connected JVC Video Printer equipped with JLIP connector.

PRINT:

- Print command is available.

EQ (equalization):

- Adjusts picture equalization.
- Video printer does not have this function.

11. SELECT (scene select) button

- Switches between "SOURCE" (images from camcorder or VCR) and "MEMORY" (scenes stored in memory) for display on TV monitor.

12. CLOSE button

- Closes the "Video Printer" window.

Adjusting picture equalization

You can adjust picture equalization; a feature not available on the video printer itself.

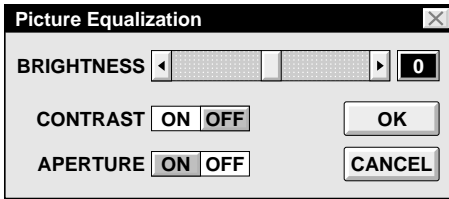

1 ACCESS PICTURE EQUALIZATION DIALOG BOX

Click "EQ" on the "Video Printer" window.

- The "Picture Equalization" dialog box appears.

2 DETERMINE ADJUSTMENT

After adjusting the items below, click "OK".

- The "Picture Equalization" dialog box closes.

BRIGHTNESS (factory preset: 0)	Move the indicator by clicking the (◀/▶) button. There are five settings from -2 to +2. - : Darken the image. + : Brighten the image.
CONTRAST (factory preset: ON):	ON : Automatically provides optimum light and shades when printing. OFF : Prints the stored scene with no adjustment.
APERTURE (factory preset: OFF):	ON : The image comes out sharp. OFF : The image comes out soft.

NOTE:

Even if connection between computer and video printer is removed, this adjustment is stored in memory. BRIGHTNESS returns to 0 only when the video printer's power cord is removed from the AC outlet.

Quitting the "Video Printer" window

1 CLICK "CLOSE"

- The "Video Printer" window closes.

Quitting the MOVIE PLAYER window

1 CHOOSE "EXIT" FROM "FILE"

- The MOVIE PLAYER window closes.

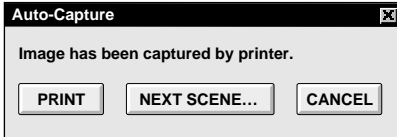

- 3 Click Title in the MOVIE PLAYER window and activate the window.
- 4 Select "Edit" — "Set Function" — "Auto Capture".
- 5 Click "START"
 - The captured video data set first is searched and stored in the video printer.
 - When the data has been stored, the message "Image has been captured by printer." appears.
 - If the number of scenes was set to "OFF", or "4 or 16" in step 2 and then to "SAME", you can start printing by clicking "PRINT".
 - If the number of scenes was set to "4 or 16" in step 2 and then to "SELECTED", click "NEXT SCENE...". The next scene is automatically searched and stored in the video printer.
- 6 Click "PRINT" to start printing.

NOTES:

To print only the cut-in scene on the edited tape

- ① Perform editing (refer to pages 50 through 52).
- ② Print (follow steps 1 through 5 above).
 - Select "Auto Capture" in step 4.
 - Click "START" in step 5. The cut-in point of Scene No. 1 is automatically searched and stored in the video printer.
 - You cannot start storing from Scene No. 2 or subsequent scenes.
 - Even if the video unit is in Stop mode, clicking "START" automatically starts playback to search the cut-in point of Scene No. 1.
 - If you want to print a particular scene only, click "SCENE" in step 5.

Changing ID number

The device's ID number is preset at factory as follows:

ex. Camcorder: 06 or 07 Video printer: 20

When connecting more than two same type devices, the same ID numbers will exist and a malfunction can occur. To avoid a malfunction, change the ID numbers.

It is recommended to change the ID number of an already connected device before connecting the same type device.

1 ACCESS "ID CHANGE" DIALOG BOX

Choose "ID Change" from "File" on the MOVIE PLAYER window.

- The "ID Change" dialog box appears.

2 SELECT DEVICE

Click on the name of the device and "CHANGE".

- The dialog box to enter new ID number appears.

3 ENTER NEW ID NUMBER

4 SET ID NUMBER

Click "OK".

- The message "The device ID will be changed." appears.

Clicking "OK" again sets that ID number and brings up the MOVIE PLAYER window.

NOTES:

- After step 4, perform the following 'Connecting other device during operation'.
- Do not enter ID number "0" because "JLIP Player Software" does not recognize "ID 0".

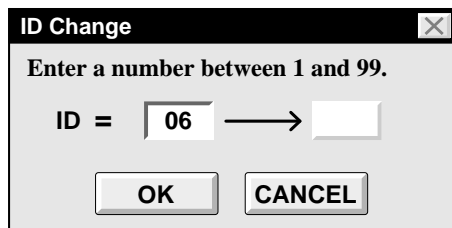
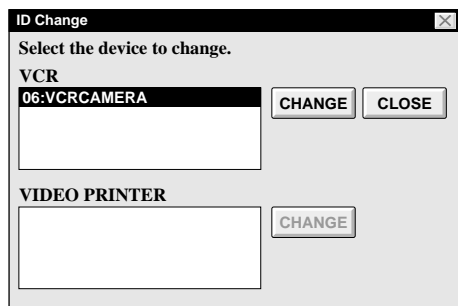

Connecting other device during operation

When connecting an other device during operation or changing ID numbers, initializing is necessary to confirm the connected devices. (Not necessary to run "JLIP Player Software" from beginning again.)

1 INITIALIZE

Choose "Initialize" from "File" on the MOVIE PLAYER window.

Changing the name of the device

1 ACCESS "NAME CHANGE" DIALOG BOX

Choose "Name Change" from "File" on the MOVIE PLAYER window.

- The "Name Change" dialog box appears.

2 SELECT DEVICE

Click on the name of the device and "CHANGE".

- The dialog box to enter new name of the device appears.

3 ENTER NEW NAME

4 SET NEW NAME

Click "OK".

- The message "Device name will be changed." appears.

Clicking "OK" again sets that device name and brings up the "Name Change" dialog box.

5 RETURN TO MOVIE PLAYER WINDOW

Click "CLOSE".

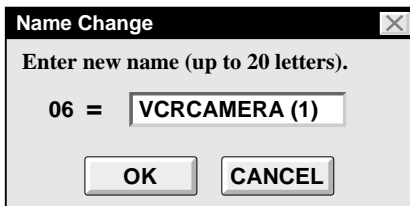
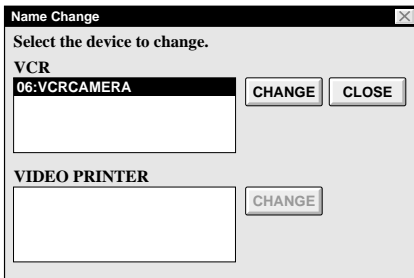

Changing the device to use while connecting over two same type devices

1 ACCESS "DEVICE SELECTION" DIALOG BOX

Choose "Device Change" from "File" on the MOVIE PLAYER window.

- The "Device Selection" dialog box appears.

2 SELECT DEVICE

Click on the name of the device and "OK".

NOTE:

It is impossible to use two same type devices simultaneously.

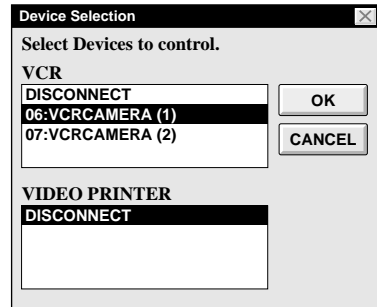

When Using the Video Capture Software

The JLIP Player Software and JLIP Video Capture Software cannot run simultaneously. When you want to run the JLIP Video Capture Software, first select "Close Serial" from "File" on the menu bar. To resume using the JLIP Player Software, click the "JLIP" button in the JLIP Video Capture Software and select "Open Serial" from "File" on the JLIP Player Software's menu bar.

Adjusting the gap between the stored edit-start point in the computer and the dubbed one in the recording deck

During dubbing, the beginning of the scene stored in the computer can be missed or the scene prior to the transition you chose for the edit-start point can be dubbed into the recording deck. When these cases occur, adjust the gap for more accurate editing.

1 CHECK EDIT-START TIMING

After dubbing (☞ pg. 52), play back the dubbed scene.

2 ACCESS "PAUSE TIME CORRECTION" DIALOG BOX

Choose "Pause Time" from "File" on the MOVIE PLAYER window.

- The "Pause Time Correction" dialog box appears.

3 ENTER VALUE

To adjust the edit-start timing, enter a new value from 0.00 sec. to 2.60 sec.

When the scene prior to the transition you chose for edit-start point is dubbed:

Enter a smaller value than 1.30.

When the beginning of the scene stored in the computer is missed:

Enter a larger value than 1.30.

- Factory preset is 1.30 sec..

4 DETERMINE VALUE

Click "OK".

- This value is stored in the computer.

5 CHECK EDIT-START TIMING AGAIN

To check the corrected edit-start timing, dub the stored scenes and play them back.

NOTE:

Even if the edit-start timing is adjusted, there can be a slight margin between the adjusted edit-start point and the dubbed scenes' one.

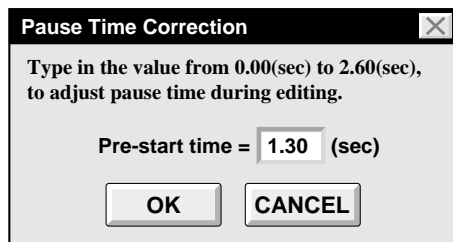
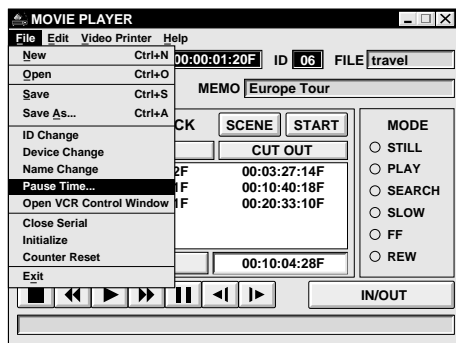

MESSAGE	<ul style="list-style-type: none"> ● POSSIBLE CAUSE ■ CORRECTIVE ACTION
<p>Error -- This application will close. Check devices -- Confirm that power is ON.</p>	<ul style="list-style-type: none"> ● The COM port used for the JLIP connector is not selected, or the COM port is selected but the connection is wrong. ■ Check the connected COM port and select it on the "Serial Port Selection" screen (☞ pg. 46).
<p>No devices detected to connect. Power ON all devices in system.</p>	<ul style="list-style-type: none"> ● Power is not supplied or the connection is wrong. ■ Connect the devices correctly and turn them on (☞ pg. 42, 43).
<p>Communication error (&H□ (number)) Check cable connection.</p>	<ul style="list-style-type: none"> ● Device is not turned on or cable is disconnected. ■ Connect the device correctly and turn it on (☞ pg. 42, 43). ■ If device was turned off and on again during operation, click "OK". All devices should function properly.
<p>Select the device to control.</p>	<ul style="list-style-type: none"> ● The line where the name of the device to use appears is not clicked. ■ Click on it and "OK" (☞ pg. 47).
<p>No video cassette!! Load a video cassette to ID □ (number).</p>	<ul style="list-style-type: none"> ● The video cassette is not loaded in the camcorder. When the video cassette is removed during operation, this message appears. ■ Insert the video cassette into the camcorder.
<p>Invalid entry in scene □ (number) (There is IN > OUT condition). Correct the time or delete the scene.</p>	<ul style="list-style-type: none"> ● The value of the CUT OUT point is smaller than the CUT IN point's. ■ Set the value of the CUT OUT point so that it is larger than the CUT IN point's (☞ pgs. 50, 54).
<p>Select a number between 0 and 29.</p>	<ul style="list-style-type: none"> ● When correcting the CUT IN/OUT points, the value you set differs from the original by over 30 frames. ■ Select integral number from 0 to 29 (☞ pg. 54).
<p>Invalid frame number on drop frame counter.</p>	<ul style="list-style-type: none"> ● Because the DV-format digital camcorder uses the drop frame system, inputting frame 00 and 01 is impossible. ■ Input frame value other than 00 or 01 (☞ pgs. 48, 54).

The monitor displays of the application software illustrated in this manual may differ from those you are actually viewing depending on the operating environment of your computer.

JLIP VIDEO CAPTURE DOCKING STATION

Connectors

S-Video	: Output Y : 1.0 Vp-p, 75 ohms
(S2 output)	C : 0.29 Vp-p, 75 ohms
Video	: Input 1.0 Vp-p, 75 ohms (pin jack) (CAPTURE INPUT (EXT.)/PRINTER connector)
	: Output 1.0 Vp-p, 75 ohms (pin jack) (VIDEO output connector)

Audio	: Output -8 dB, 1 kilohm (pin jack)
JLIP (x 2)	: 3.5 mm dia., 4-pole, mini-head jack (compatible with EIAJ RC-5325 plug)

Digital	: Mini DIN 8-pin
----------------	------------------

Multi-connector	: 34-pin
------------------------	----------

Editing connector	: 3.5 mm dia., 2-pole
--------------------------	-----------------------

DC output	: 5 V DC
------------------	----------

Captured image sizes	: 640 x 480 pixels, 80 x 60 pixels
-----------------------------	------------------------------------

Operating temperatures	: 5 to 30° C
-------------------------------	--------------

Dimensions	: 113W x 61H x 145D mm
-------------------	------------------------

Weight	: Approx. 395 g
---------------	-----------------

Power supply	: 6.3 V DC
---------------------	------------

** E. & O. E. Design and Specifications subject to change without notice.*







A

- Arrange Index  pg. 31
- Automatic Capture (AUTO)  pg. 26, 28





B

- Bitmap  pg. 24, 29



C

- Capture Mode  pg. 29
- Change ID  pg. 31, 62
- COM Port  pg. 18, 46
- Counter reset  pg. 30
- Counter Value Change  pg. 30
- Create New Folder  pg. 32





D

- Delete Index Image and Full Image
.....  pg. 31
- Desktop Window  pg. 20, 48, 56
- Device Selection  pg. 19
- Dubbing  pg. 52

E

- Edit Menu  pg. 22
- Exit (Close)  pg. 17







F

- Field Picture  pg. 29
- File Menu  pg. 22
- Frame Picture  pg. 21, 29, 48
- Full image data  pg. 21

H

- Help Menu  pg. 23, 49



I

- Index image  pg. 21, 26, 28
- Index image data  pg. 21
- Initialize  pg. 17, 31, 46
- Input button  pg. 20
- Install  pg. 15, 45
- Interval Capture  pg. 28
- IRQ  pg. 37



J

- JPEG  pg. 29



M

- Main Window  pg. 20
- Memory button  pg. 20
- Menu bar  pg. 20, 48





O

- Open JLIP (jlp) File  pg. 34
- Open Album  pg. 33
- Operate VCR  pg. 23, 49

P

- Picture Format  pg. 29
- Program Capture  pg. 26 – 27



S

- Save As JLIP (jlp) File  pg. 35
- Save Image As  pg. 33
- Setup Menu  pg. 22, 25
- Step by Step Capture  pg. 25
- Save Album  pg. 33

T

- Transfer Rate  pg. 18

V

- Video Capture  pg. 24 – 28
- Video Printer  pg. 58 – 60

W

- Window Menu  pg. 20



JVC

JVC COMPANY OF AMERICA

DIVISION OF US JVC CORP.
41 Slater Drive, Elmwood Park, N.J. 07407

JVC CANADA INC.

21 Finchdene Square, Scarborough Ontario M1X 1A7