

Music Anywhere!™ Kit IN-CEILING



Niles Audio Corporation
12331 SW 130th Street Miami Florida 33186
TEL: (305) 238-4373 FAX: (305) 238-0185
www.nilesaudio.com

©1999 All Rights Reserved. Niles Audio Corporation. Because Niles strives to continuously improve its products, Niles reserves the right to change product specifications without notice. Niles, the Niles logo and Blending High Fidelity and Architecture are registered trademarks of Niles Audio Corporation Music Anywhere! Decora is a registered trademark of Leviton Manufacturing Company. Lexan is a registered trademark of General Electric Company, Inc. 10/98 DS00226B





IMPORTANT INFORMATION

The Music Anywhere! In-Ceiling Kit is designed to provide years of trouble-free operation. For your protection, please read through these instructions and the enclosed manuals thoroughly before proceeding with your installation. Keep all enclosed manuals for future reference.

Carefully observe and comply with all warnings, cautions and operating instructions described in all enclosed manuals.

WARNING!

To prevent possible injury, the following basic safety precautions should be observed in the installation and use of your Music Anywhere! In-Ceiling Kit.

1. **Read through all enclosed manuals** — Before attempting any installation, read through all manuals thoroughly and keep them for future reference.
2. **Avoid contact with all high-voltage electrical wiring and equipment!**
3. **Keep the Volume Control and any exposed wiring away from water and moisture** — Never install electronic products near water, i.e., near a bathtub, sink, washing machine, in a wet basement, near a swimming pool, hot tub, or anywhere else the product may be directly exposed to water or moisture.
4. **Check your local building and electrical codes** — There may be specific requirements regarding running low-voltage in your area.

Tools Needed

- pencil
- drywall saw
- standard screwdriver
- phillips screwdriver
- wire strippers
- drill (and assorted bits)
- wire coat hanger
- level (optional)

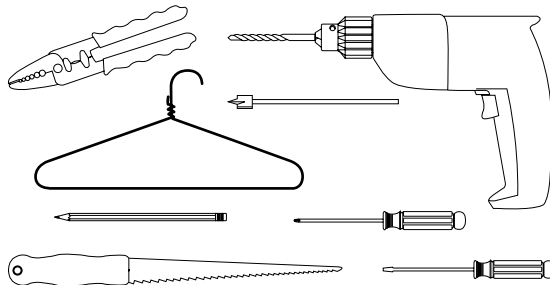

TABLE OF CONTENTS



Introduction	2
Installation	3
Positioning your Speakers for the Best Sound Quality	3
Finding the Right Spot to Install the Wall-Mount Volume Control	3
Safety Check	4
Cutting the Hole	5
Installing the Mounting Bracket	5
Running the Speaker Cable	5
Connecting the Speaker Cable to the Wall-Mount Volume Control	6
Installing the Wall-Mount Volume Control in your Wall	7
Mounting the In-Ceiling Speakers	7
Connecting the Speaker Cable to your Equipment	8
Adding On	8
Connecting Additional Speakers and Volume Controls	8
Protecting your Amplifier	8
System Operation	9
Normal Operation	9
Accessories	10

INTRODUCTION



The Music Anywhere! In-Ceiling Kit enables you to enjoy your favorite music in the kitchen, in the bedroom, or in the den — anywhere you desire terrific sound.

Kit Contents

Check that your Music Anywhere! In-Ceiling Kit contains the following:

- One Pair of In-Ceiling Speakers
- Volume Control
- Speaker Cable (100 ft.)
- Mounting Bracket



In-Ceiling Speakers

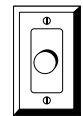

Wall-Mount Volume Control



Mounting Bracket

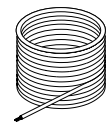

Speaker Cable (100 ft.)

The following is an overview of the installation of the Music Anywhere! In-Ceiling Kit. In some cases you should refer to the specific product manuals for additional information.

Positioning your Speakers for the Best Sound Quality

Decide on an appropriate installation location for your In-Ceiling Speakers. They may be installed in any standard ceiling of at least a 3/8" thickness. Best results are achieved by installing the In-Ceiling Speakers an equal distance from the main listening position whenever possible.

⚠ DO NOT MOUNT THE SPEAKERS AT THIS TIME

Finding the Right Spot to Install the Wall-Mount Volume Control

Decide on a location for the Wall-Mount Volume Control that is convenient for you and where you believe the Speaker Cable will easily reach.

⚠ The Wall-Mount Volume Control should be installed indoors, in an interior wall relatively close to the area where the speakers will be mounted. The VCS-2D-IM Volume Control included with the Music Anywhere! In-Ceiling Kit is not waterproof and is not suitable for installation outdoors without a Niles WDC-100 weatherproof cover. (See Page 10)

⚠ Be sure to measure the approximate distance from your equipment to the Wall-Mount Volume Control location, and from the Wall-Mount Volume Control to the first and second Speaker locations. This will ensure that you have enough wire to complete the installation. The Music Anywhere! In-Ceiling Kit includes 100 ft. of 4-conductor Speaker Cable. (See Figure 1)

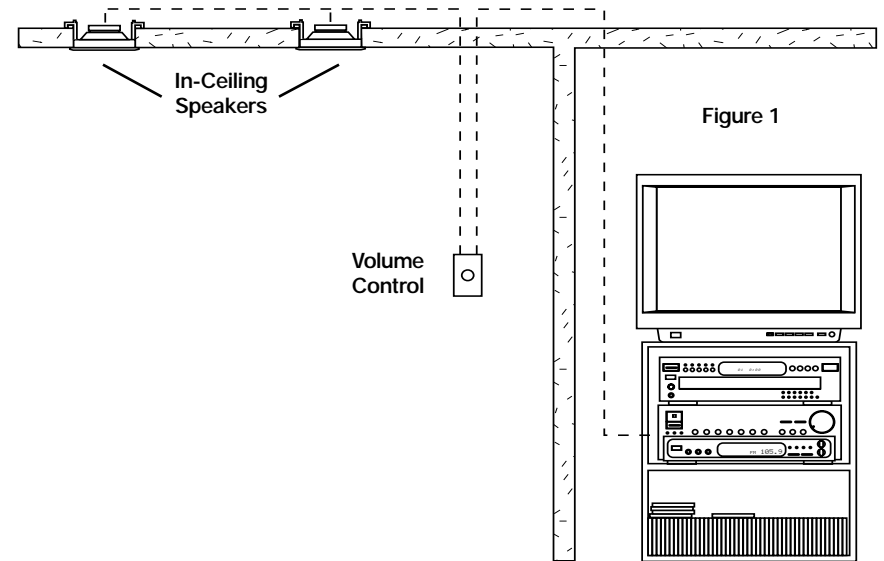

Figure 1

Safety Check

⚠ If you have doubts about whether you are capable of installing a Niles Music Anywhere! In-Wall Kit into your system, consult a Niles dealer or professional installer. They have special tools, techniques, and experience to make the impossible possible. The installer can provide you with an estimate before work is started.

Once you have found a convenient location for the Wall-Mount Volume Control and decided on an installation location for the In-Wall Speakers, locate nearby studs in the wall with a stud sensor or by hand knocking.

When you've found locations that appear to be free of obstructions, drill a small 1/8" pilot hole just barely through the drywall in each location. (See Figure 2)

⚠ Be careful. If you feel any extra resistance as you are drilling. STOP!

Cut a piece of coat hanger and bend the wire to create two right angles opposite of each other about six inches long. Poke the six inch end of the "Z-shaped" wire into the pilot hole and rotate in a circle while probing the inside of the wall for obstructions.

Figure 2

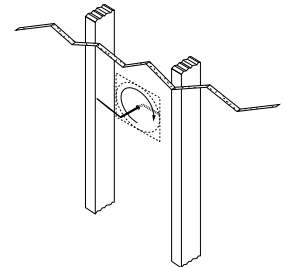

If the wire's movement is obstructed by a pipe, cable or wall stud, fill the hole with spackle or other patching compound, sand, paint and try another location.

Cutting the Hole

Once you have decided upon an ideal installation location for the Wall-Mounted Volume Control, hold the Mounting Bracket up to the wall surface. Level the Mounting Bracket and mark the wall by tracing the inside perimeter of the Mounting Bracket with a pencil. Repeat the same procedure for the In-Ceiling Speakers using the supplied template to trace a 9-1/4" diameter hole for each In-Ceiling Speaker. (See Figure 3)

When the bracket is secure, bend the tabs back against the inside of the drywall and insert the screws so that they penetrate the tabs, clamping the bracket to the drywall. (See Figure 7)

Running the Speaker Cable

Conceal the Speaker Cable between the stereo equipment and the Wall-Mount Volume Control, and between the Wall-Mount Volume Control and the Speakers.

⚠ Be sure to measure the approximate distance from your equipment to the Wall-Mount Volume Control location, and from the Wall-Mount Volume Control to the first and second Speaker locations to ensure that you have enough wire to complete the installation. (See Figure 8)

Figure 3

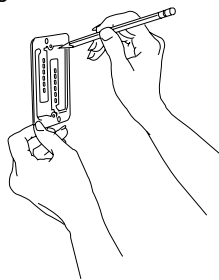

Figure 4

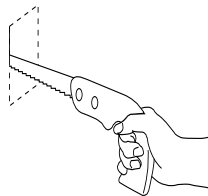

Figure 5

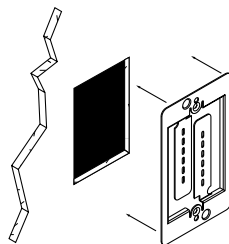

Figure 7

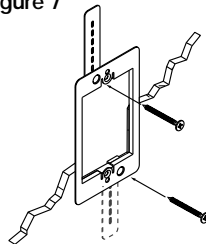
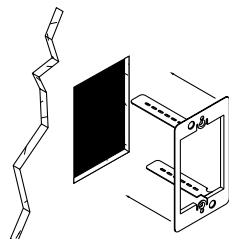

Figure 6



If you are cutting a painted or wallpapered ceiling, use a razor-knife to cleanly cut the wallpaper. Then use a drywall saw to cut the drywall. (See Figure 4)

⚠ Be very careful not to saw through existing wires, pipes or structure.

Installing the Mounting Bracket

Place the Mounting Bracket against the hole. (See Figure 5)

Bend the tabs at a 90° angle and insert into the hole. (See Figure 6)

Connecting the Speaker Cable to the Volume Control

⚠ Connecting the Volume Control backwards could damage your amplifier. Make sure to connect the Speaker Cable coming from your amplifier to the INPUT of the Volume Control (labeled AMPLIFIER), and the OUTPUT of the Volume Control (labeled SPEAKERS) to the In-Ceiling Speakers.

Strip the wire jacket back 2" to expose the four colored

conductors and remove 1/4" of insulation from the end of each conductor. Twist the end of each conductor so the ends are not frayed. Make sure that no more than 1/4" of bare wire is exposed.

⚠ Exposing too much wire could cause the wires to touch and create a "short" which could damage your equipment.

Connect the exposed ends of each of the Speaker Cable's conductors to the removable connectors pack-

aged with the Wall-Mount Volume Control. (See "Connect the wires" at the bottom of page 7.)

If you are going to connect more than two pairs of speakers to the amplifier, the Volume Control's "Impedance Magnifying" jumpers must be reset. (See Figure 10, Page 8 of this manual)

Refer to the Installation section on page 8 of the VCS-2D-IM Volume Control manual included with your Music Anywhere! In-Ceiling

Figure 8

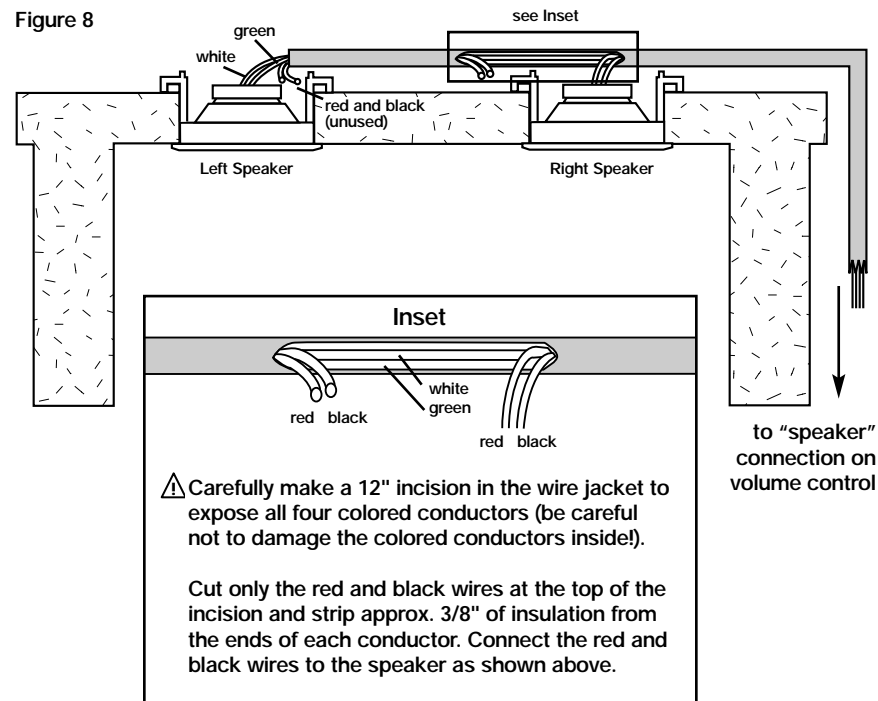

Installing the Wall-Mount Volume Control in your Wall

Carefully feed the Speaker Cable back into the wall and secure the Wall-Mount Volume Control to the bracket using the supplied screws. Then install the Decora® faceplate using the supplied faceplate screws. (See Figure 9)

Speaker, conceal the excess wire inside the ceiling cavity.

To install the in-Ceiling Speakers, first rotate the clamps inward so that they sit flush against the side of the speaker. Insert the In-Ceiling Speaker into the cutout and tighten the clamps by turning the screws clockwise with a drill or by hand.

Mounting the In-Ceiling Speakers

Remove the grille from the In-Ceiling Speaker by bending the last quarter inch of a small paper clip into an "L" shape and inserting it into one of the holes at the edge of the grille. Figure 8 illustrates how to connect the Speaker Cable to the In-Ceiling Speakers.

⚠ DO NOT OVERTIGHTEN THE SCREWS. Overtightening the screws may break the clamps or make the grille difficult to install.

Carefully install the grille into the speaker. The grilles fit tightly to prevent them from coming loose over time. Some effort and care may be required when installing them.

⚠ Be sure to observe proper polarity when connecting the Speaker Cable to the In-Ceiling Speakers.

Connect the wires:
⚠ Red = Right Positive (+)
Black = Right Negative (-)
White = Left Positive (+)
Green = Left Negative (-)

Once the Speaker Cable is connected to the In-Ceiling

Figure 9

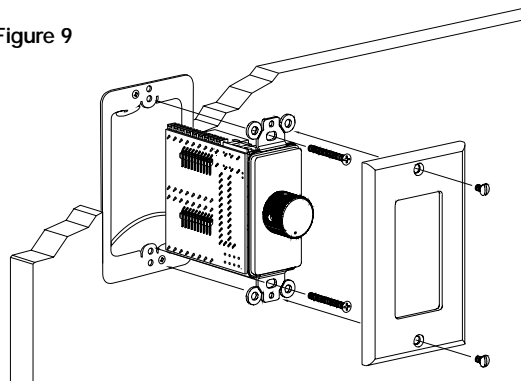

Connecting the Speaker Cable to your Equipment

If your receiver or amplifier has both "Speakers A" and "Speakers B" connections on the rear of the chassis, connect the Cable connected to the Speakers to "A". Be sure to observe proper polarity when connecting the Speaker Cable to your equipment.

Connect the wires:
Red = Right Positive (+)
Black = Right Negative (-)
White = Left Positive (+)
Green = Left Negative (-)

Connecting Additional Speakers and Volume Controls

In order to listen to several speaker pairs at the same time, each run of Speaker Cable (and their respective Wall-Mount Volume Controls and Speakers) must be connected to your amplifier. This is easily accomplished by using standard wire nuts and connecting the other speaker pairs to your amplifier in the following manner:

a) Simply cut a short "pigtail" (approximately 12") of 4-conductor Speaker

Cable and remove 2" of the outer sheath from both ends. Strip 3/8" of the colored insulation from each of the four conductors at one end, and connect this end to your stereo amplifier's output terminals.

Connect the wires
Red = Right Positive (+)
Black = Right Negative (-)
White = Left Positive (+)
Green = Left Negative (-)

b) Strip 3/4" of insulation from both the end of the "pigtail" and from the end of each of the incoming Speaker Cable's conductors.
 c) Connect each of the "pigtail's" conductors to its corresponding color on the incoming Speaker Cable

feeds by twisting the wires together and securing them with a wire nut of the appropriate size.

Protecting Your Amplifier

The Wall-Mount Volume Controls included in the Music Anywhere! Kits incorporate an "Impedance Magnifying" feature to protect your amplifier.

To set the "Magnification Factor", simply straddle the small black "jumper" over the appropriately marked "jumper pins" for the correct magnification setting based on the number of speaker pairs in your system. (see Figure 10)

Figure 10

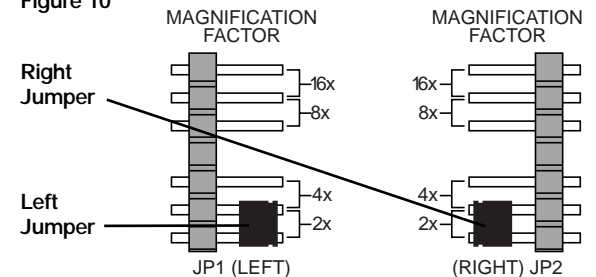

SETTING THE MAGNIFICATION FACTOR

1 - 2 speakers pairs	set jumper on 2X
3 - 4 speakers pairs	set jumper on 4X
5 - 8 speakers pairs	set jumper on 8X
9 - 16 speakers pairs	set jumper on 16X

⚠ **Every Wall-Mount Volume Control in the system must be set to the same "Impedance Magnification" factor.**

ly off. When the Volume Control is set all the way up, the speakers will play at the amplifier's preset volume setting.

⚠ **Do not mix other models of Niles (or any other manufacturer's) volume controls with Niles VCS-2D-IM Wall-Mount Volume Controls in this type of system configuration.**

⚠ **Use caution when listening to your In-Ceiling Speakers at high volume levels. Turning up your amplifier's volume too far may cause the amplifier to run out of power which can create "clipping" distortion, which may potentially damage your amplifier, volume control, and speakers.**

Normal Operation

Start by presetting the volume control on your amplifier at a reasonable level. The amplifier volume control is now the Master Volume for all of your speakers. Each room Volume Control enables you to reduce the volume of that room without affecting anyone else.

To control the volume of your In-Ceiling Speakers, simply turn the Wall-Mount Volume Control clockwise to increase the volume, and counter-clockwise to decrease the volume.

When the Volume Control is all the way down, the speaker system is complete-

⚠ **Typically, an amplifier reaches its maximum capabilities when playing a CD at a 12 o'clock setting. If you increase the amplifier's volume control beyond that point, the amplifier will begin to distort. This "clipping" distortion will quickly damage the tweeters of any speaker (regardless of its power rating — power ratings refer to undistorted sound).**

⚠ **If the treble sounds harsh and unpleasant when you are standing near your In-Ceiling Speakers, reduce the amplifiers volume to a safe, undistorted level.**

Double-Gang Mounting Kit

Used for applications where the mounting of two Decora® style low-voltage controls next to one another is desired. This kit includes a double-gang Decora-style faceplate, double-gang mounting bracket, and all the necessary hardware.

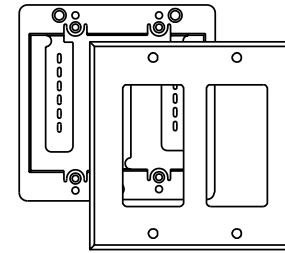

Double-Gang Mounting Kit
Stock# FG00783

WDC-100 and WDC-200 Weatherized Device Covers

These paintable outdoor covers are designed to enable you to install either single-gang (WDC-100), or double-gang (WDC-200) control devices outdoors and keep them protected from the elements. Both models are constructed of durable Lexan® plastic and feature Neoprene sealing gaskets and stainless steel mounting screws.

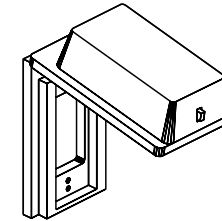

WDC-100
Stock# FG00289

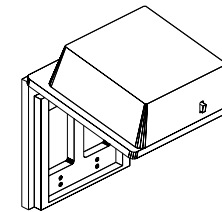

WDC-200
Stock# FG00290