

Use & Care Guide

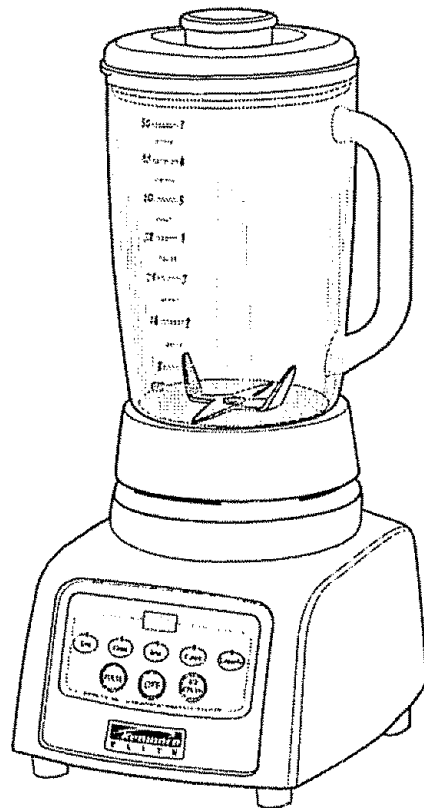

Blender
5 Speed

Model No.
100.90001



CAUTION: Read, understand and follow all Important Safeguards and Operating Instructions in this Manual before using this product.



Sears, Roebuck and Co., Hoffman Estates, IL 60179 U.S.A.
www.kenmore.com

WARRANTY

KENMORE ELITE FULL WARRANTY

If this product fails due to a defect in material or workmanship within five years from the date of purchase, return it to any Sears store or other Kenmore outlet in the United States for free replacement

If the motor of this product fails due to a defect in material or workmanship within 10 years from the date of purchase, return this product to any Sears store or other Kenmore outlet in the United States for free replacement

This warranty does not include expendable parts, such as filters or blades, which can wear out from normal use within the warranty period

This warranty applies for only 90 days if this product is ever used for other than private household purposes

This warranty applies only while this product is used in the United States.

This warranty gives you specific legal rights, and you may also have other rights which vary from state to state.

Sears, Roebuck and Co., Hoffman Estates, IL 60179

IMPORTANT SAFEGUARDS

When using electrical appliances, basic safety precautions should always be followed, including the following:

- 1 **READ** all instructions.
- 2 To protect against risk of electrical shock do not put blender in water or other liquid
- 3 Close supervision is necessary when any appliance is used by or near children.
- 4 **UNPLUG** from outlet when not in use, before putting on or taking off parts, and before cleaning.
- 5 **AVOID** contact with moving parts
- 6 **DO NOT** operate any appliance with a damaged cord or plug, or after the appliance malfunctions or has been dropped or damaged in any manner. Return appliance to the nearest authorized service facility for examination, repair or adjustment.
- 7 The use of accessory attachments, including canning jars, not recommended by the appliance manufacturer may cause a risk of personal injury
- 8 **DO NOT** use outdoors
- 9 **DO NOT** let the cord hang over the edge of table or counter
10. Keep hands and utensils out of container while blending to reduce the risk of severe injury to persons or damage to the blender. A scraper may be used, but must be used **ONLY** when the blender is not running.
- 11 Blades are sharp. Handle carefully

IMPORTANT SAFEGUARDS

12. To reduce the risk of injury, never place cutter-assembly blades on base without jar properly attached.
13. **ALWAYS** operate blender with cover in place.
14. When blending hot liquids, remove measuring cup from the two-piece lid. Do not fill jar beyond 3-cup level.
15. To protect against electrical shock, this appliance is equipped with a cord having a 3-prong grounding-type plug for insertion into a proper grounding-type receptacle. **DO NOT** alter the plug for use in a 2-prong receptacle. If the plug will not fit into a receptacle, have the proper receptacle installed by a qualified electrician.
16. **SAVE THESE INSTRUCTIONS!**

PARTS AND FEATURES

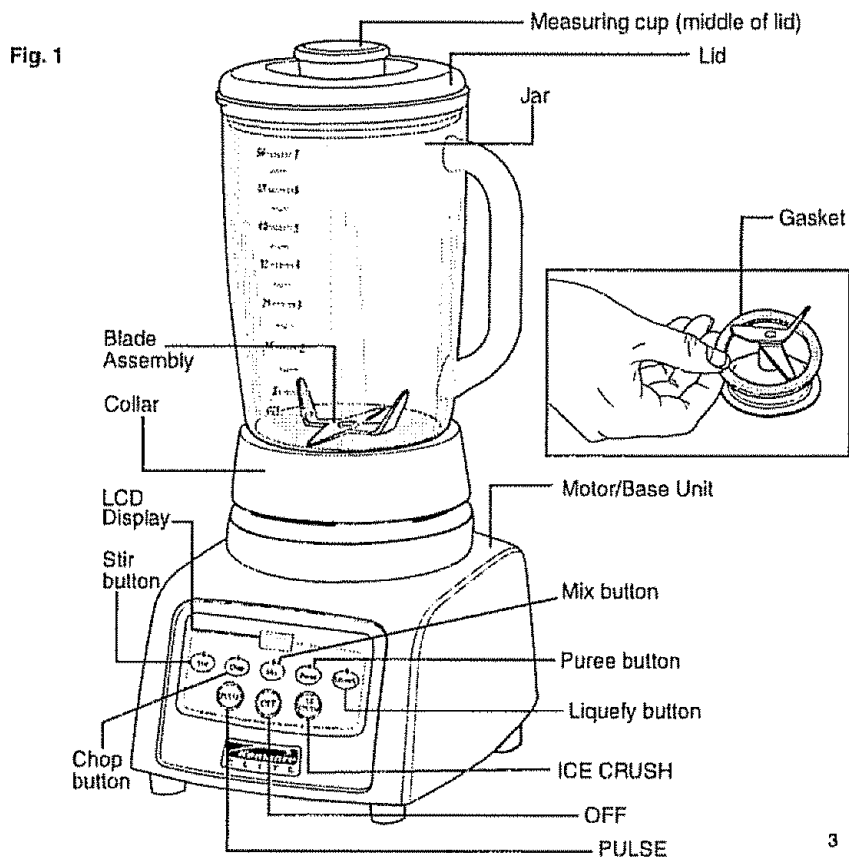

PREPARING YOUR BLENDER

1. Before assembling your blender, wipe blender base with a warm sudsy cloth, then wipe clean with a damp cloth. Dry with a soft cloth. Wash blender jar, lid, collar and blades in warm, sudsy water. Rinse and wipe parts dry.

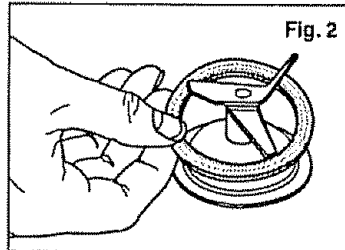

2. Turn blender jar upside down. Place the gasket on the blade assembly (Fig. 2)

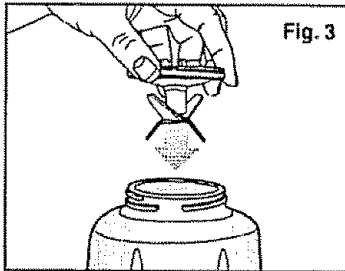

3. Place the blade assembly with the gasket in the bottom opening of the jar (Fig. 3).

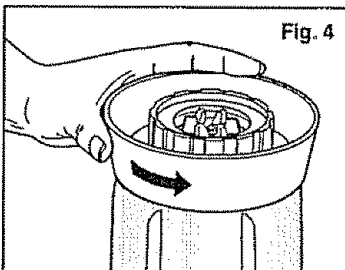

4. Twist collar onto jar. Be sure to engage threads properly and securely (Fig. 4). Turn assembled jar right side up (Fig. 5).

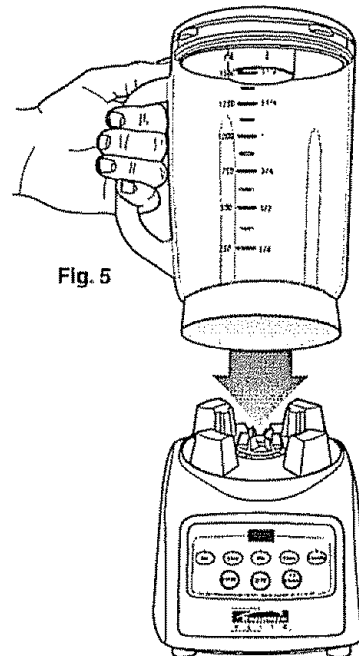

CAUTION: Blades are sharp. Handle carefully.



CAUTION: NEVER place blender's motor/base in water or other liquids.

OPERATING YOUR BLENDER

Your blender has been designed to work in a variety of ways to suit your blending needs. Once you plug the blender in, the OFF button illuminates. Operate the blender in either continuous or pulse mode by pressing the speed buttons. The blender has a soft start function when used in the continuous mode (Fig. 6)

1. Make sure the power cord is unplugged
2. Place Blender motor/base on a dry level, stable surface
3. Set jar assembly into place on motor/base, making sure motor/base and jar are securely tightened into place
4. Place the food solids and liquids to be blended into the jar and put the lid on the jar before blending. Be sure the measuring cup is in place in the middle of the lid
5. Plug power cord into a standard 120-V, 60 Hz AC-only, 3-prong electrical outlet. The blue LCD display will say, 0:00 for the timer, and the blue Off indicator light will illuminate (Fig. 7).

Fig. 6

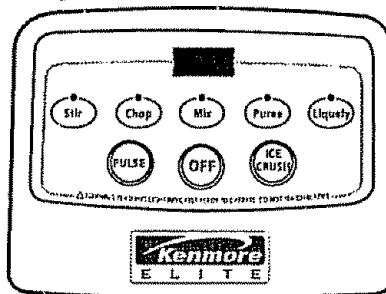
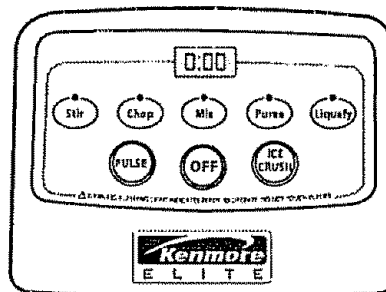

Fig. 7



OPERATING YOUR BLENDER

6. To turn on the blender in continuous mode, press one of the following speed buttons: Stir (slowest), Chop, Mix, Puree, or Liquefy (fastest). The button for the speed you select will illuminate blue and the blender's timer will start counting the seconds the blender is in operation.

The blender will run continuously after you press the button and until you press the same button again, or press the OFF button.

You can change blender speeds by pressing a different button without first pressing OFF. The timer feature will continue while you are blending and will pause in its count when you re-push a speed button to shut the blender off. The timer will re-set itself to zero only if you press the OFF button.

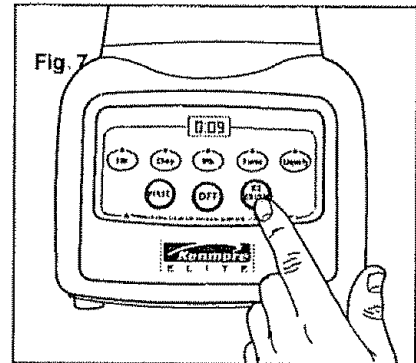

7. To run the blender intermittently (pulse mode) rather than continuously, first press the PULSE button. The PULSE button light will flash blue. Then press one of the five speed buttons above it. The speed button you press will illuminate blue. Then press and hold down the PULSE button to run the blender at that speed. When you release the button the blender will stop and turn OFF.



WARNING: Flashing light indicates ready to operate.
Do not touch blades.

8. The Ice Crush button is the highest and strongest blender speed. The blender will begin to operate at this speed as soon as you press the button, but will only continue to operate as long as you hold the button down. While the button is pressed, it illuminates blue. As soon as you stop pressing the button, the blender turns OFF.
9. As a safety feature, the timer on the blender will shut the blender off when it reaches 5 minutes. It will then be in the OFF mode with the blue OFF button illuminated.
10. To add food or fruit to the jar while the blender is running, remove the measuring cup in the middle of the lid. Add the food or fruit through the hole in the middle of the lid and then replace the measuring cup on lid. NEVER start up the blender without the lid in place. The speed of the blades will throw contents high up in the jar and without the lid it could spill out.

NOTE: Only operate blender in one speed at a time.

BLENDER TIPS AND TECHNIQUES

For quicker, easier blending, cut food into 2-in. long pieces before adding to blender jar. To chop, grate or prepare fruit smoothies, with either fresh or frozen fruit, cut fruit into about 3/4-inch long pieces.

To best circulate foods or fruit that are to be blended with liquid, pour the liquid into the jar first, then add the solid foods or fruit.

Some tasks cannot be performed efficiently with a blender. These are: Beating egg whites, whipping cream, mashing potatoes, grinding meats, mixing dough, and extracting juices from fruit and vegetables.

The following items should never be placed in the blender jar, as they can cause damage: Bones, large pieces of solid frozen foods, or dense, tough foods such as turnips.

To crush ice, **ALWAYS** have liquid in the jar. Start out with 2 cups of liquid, and add about 2 cups of ice cubes. Hold one hand firmly on the lid. Push the Ice Crush button.

If more ice is needed, remove the measuring cup in the middle of the lid and add cubes one at a time through the hole in the lid. **DO NOT CRUSH ICE WITHOUT LIQUID**

Failure to follow these directions can result in damage to the blades, jar, blender motor, and possibly result in personal injury.

CARE AND CLEANING

If you should ever need replacement parts for this blender, contact Sears Parts and Repair Service at 1-800-4-MY-HOME[®].

1. Before cleaning, unplug the blender.
2. Rinse parts (jar, blade assembly, gasket, collar, lid and measuring cup inner lid) immediately after blending for easier cleanup.
3. All removable parts can be washed by hand or in a dishwasher. The lid, measuring cup, collar, gasket and blade assembly should be placed in the top rack only. Disassemble before placing in the dishwasher. The jars are bottom rack dishwasher-safe. Do not place the jar or any other parts in boiling liquids.
4. The motor/base is designed to be resistant to liquids. If liquids spill into the motor/base
 - Unplug the motor/base
 - Wipe with a damp cloth and dry thoroughly
5. Do not use abrasive scouring pads or cleaners on base as finish may become scratched or damaged.

Get it fixed, at your home or ours!

Your Home

For repair – in your home – of all major brand appliances, lawn and garden equipment, or heating and cooling systems, **no matter who made it, no matter who sold it!**

For the replacement parts, accessories and owner's manuals that you need to do-it-yourself.

For Sears professional installation of home appliances and items like garage door openers and water heaters.

1-800-4-MY-HOME[®] Call anytime, day or night
(1-800-469-4663) (U.S.A. and Canada)
www.sears.com www.sears.ca

For expert home solutions advice: www.managemyhome.com

Our Home

For repair of carry-in products like vacuums, lawn equipment, and electronics, call or go on-line for the nearest **Sears Parts & Repair Service Center**

1-800-488-1222 (U.S.A.) **1-800-469-4663** (Canada)
Call anytime, day or night
www.sears.com www.sears.ca

To purchase a protection agreement on a product serviced by Sears:

1-800-827-6655 (USA) **1-800-361-6665** (Canada)

Para pedir servicio de reparación a domicilio, y para ordenar piezas:

1-888-SU-HOGAR[®]
(1-888-784-6427)

Au Canada pour service en français:

1-800-LE-FOYER^{MC}
(1-800-533-6937)
www.sears.ca



© Sears Brands, LLC

® Registered Trademark / TM Trademark / SM Service Mark of Sears Brands, LLC

® Marca Registrada / TM Marca de Fábrica / SM Marca de Servicio de Sears Brands, LLC

^{MC} Marque de commerce / ^{MS} Marque déposée de Sears Brands, LLC