

SAMSUNG

OWNER'S INSTRUCTIONS MANUAL DE INSTRUCCIONES MANUEL D'UTILISATION

Indoor Unit

AS07A5(6)MA
AS09A5(6)MAF
AS12AA(B)MCF
AS18A9(0)RCF
AS18A9(0)RCFD
AS24A1(2)RC
AS24A1(2)RCD

Outdoor Unit

US07A5(6)MA
US09A5(6)MAF
US12AA(B)MCF
US18A9(0)RCF
US18A9(0)RCFD
US24A1(2)RC
US24A1(2)RCD

ENGLISH

ESPAÑOL

FRANÇAIS

Split-type Room Air Conditioner (Cool)
Aire acondicionado doméstico sistema Split (Refrigeración)
Climatiseur de type Séparé (Refroidissement)

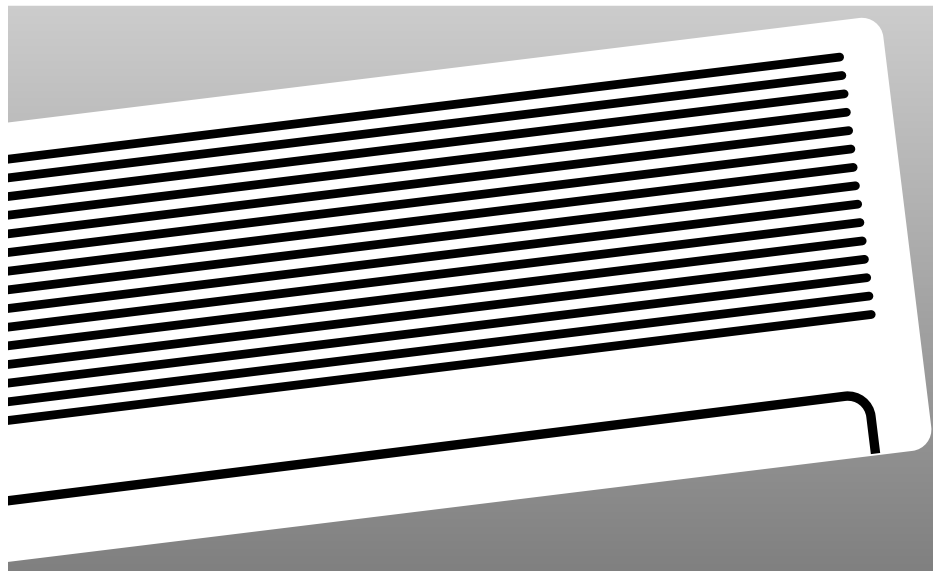

Safety Precautions

The following safety precautions must be taken when using your air conditioner.



WARNING

Risk of electric shock. • Can cause injury or death. • Disconnect all remote electric power supplies before servicing, installing or cleaning. • This must be done by the manufacturer or its service agent or a similar qualified person in order to avoid a hazard.

DURING OPERATION

- ◆ Users of this product are cautioned not to attempt repair of this product at their own discretion. Instead, they are requested to directly contact a designated service center or the outlet at which the product was purchased.
- ◆ Never spill any kind of liquid into the unit. Should this happen, unplug or main switch off the unit and contact an authorized service center.
- ◆ Do not insert anything between the air outlet blades because the inner fan may be damaged and could cause injury. Keep children away from the unit.
- ◆ Do not place any obstacles in front of the unit.
- ◆ Do not spray liquid of any kind into the indoor unit. Should this happen, switch off the breaker used for your air conditioner and contact your installation specialist.
- ◆ Make sure that the unit is correctly ventilated at all times:
Do not place clothing or other materials over it.
- ◆ If the wireless remote control will not be used for a long time, remove the batteries. (If applicable)
- ◆ When using a wireless remote control, the distance should not be more than 23ft(7m) from the air conditioner. (If applicable)

DISPOSING OF THE UNIT

- ◆ Before throwing out the device, it is necessary to pull back the battery cells and get rid of them safely for recycling reasons.
- ◆ When you need to dispose of the unit, consult your dealer. If pipes are removed incorrectly, refrigerant may blow out and come into contact with your skin, causing injury. Releasing refrigerant into the atmosphere also damages the environments.
- ◆ Please recycle or dispose of the packaging material for this product in an environmentally responsible manner.

OTHERS

- ◆ Never store or ship the air conditioner upside down or sideways to avoid damage to the compressor.
- ◆ The appliance is not intended for use by young children or infirm persons without supervision: Young children should be supervised to ensure that they do not play with the appliance.
- ◆ Max current is measured according to IEC standard for safety and current is measured according to ISO standard for energy efficiency.

Contents

◆	PREPARING YOUR AIR CONDITIONER	
■	Safety Precautions	2
■	View of the Unit	4
■	Remote Control-Buttons and Display	6
■	Getting Started	7
■	Inserting the Remote Control Batteries	8
■	Installing the Remote Control Holder	8
◆	OPERATING YOUR AIR CONDITIONER	
■	5 Way Function	9
■	Selecting the Automatic Operating Mode	10
■	Cooling Your Room	11
■	Changing the Room Temperature Quickly	12
■	Removing Excess Humidity	13
■	Airing Your Room	14
■	Adjusting the Air Flow Direction Vertically	15
■	Adjusting the Air Flow Direction Horizontally	15
◆	PROGRAMMING YOUR AIR CONDITIONER	
■	Setting the On Timer	16
■	Setting the Off Timer	17
■	Setting the Sleep Timer	18
◆	RECOMMENDATIONS FOR USE	
■	Operating Recommendations	19
■	Temperature and Humidity Ranges	20
■	Cleaning Your Air Conditioner	21
■	Solving Common Problems	22
■	Installing a Filter (Option)	23
◆	TECHNICAL SPECIFICATIONS	

View of the Unit

The design and shape are subject to change according to the model.

Indoor Unit

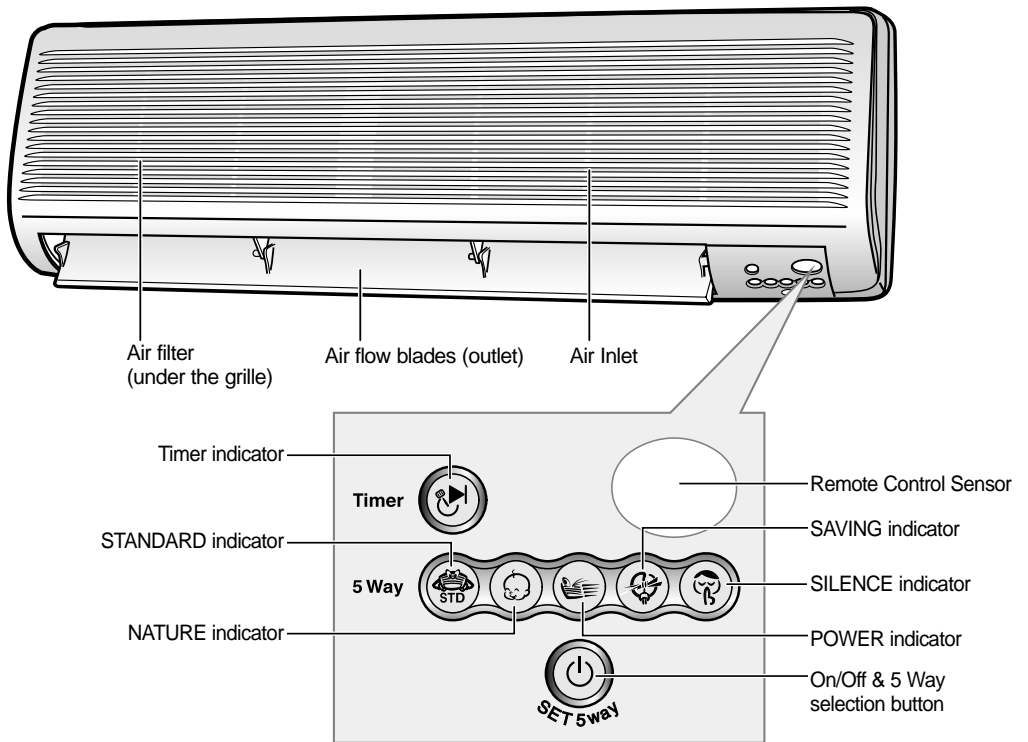

Note ◆ For details on the 5 Way, refer to page 9.

Outdoor Unit US07A5(6)MA US09A5(6)MAF

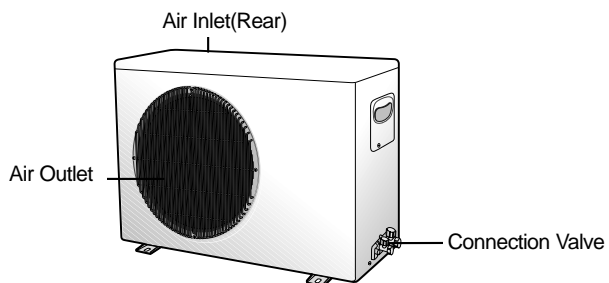

Outdoor Unit US12AA(B)MCF

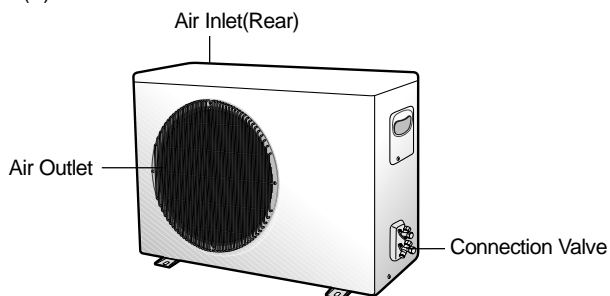

Outdoor Unit US18A9(0)RCF US18A9(0)RCFD US24A1(2)RC

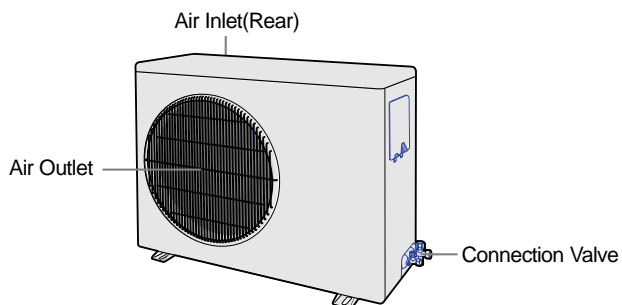

Outdoor Unit US24A1(2)RCD

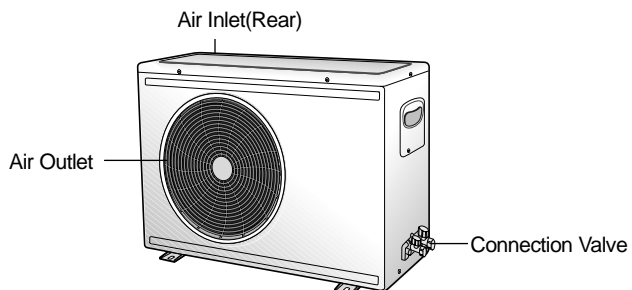

Remote Control - Buttons and Display

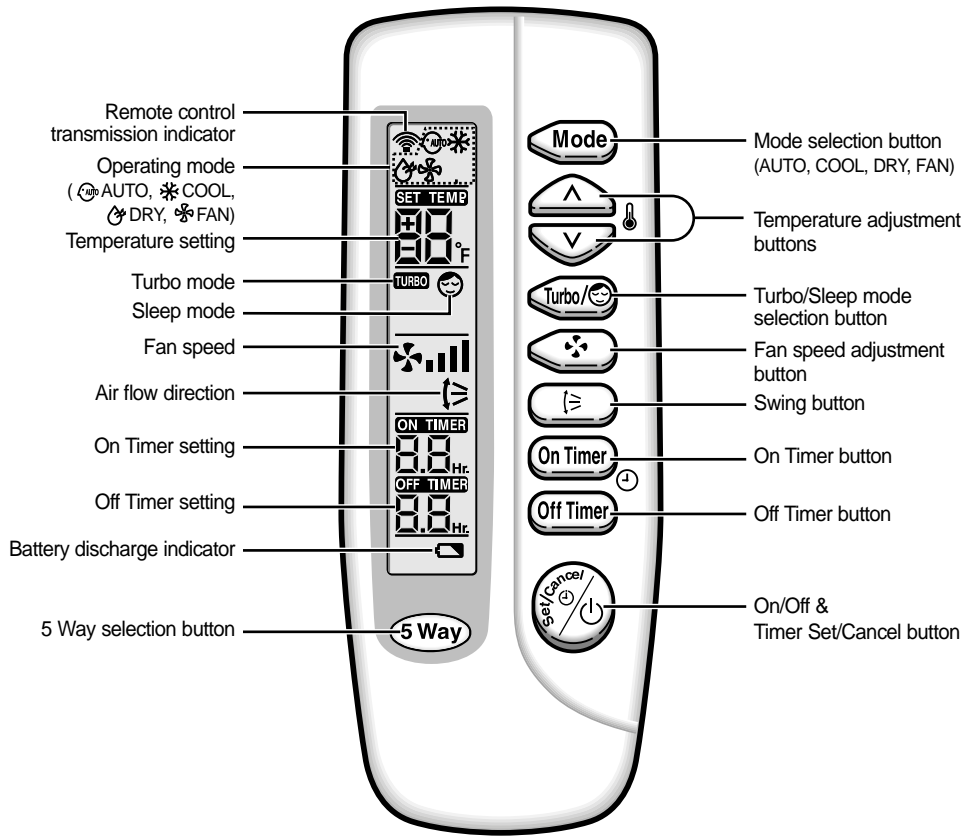

Getting Started

You have just purchased a split type air conditioner and it has been installed by your installation specialist.

Your Owner's Instructions contains valuable information on using your air conditioner. Please take the time to read it as it will help you take full advantage of the unit's features.

The booklet is organized as follows.

- ◆ *The following figures are shown on pages from 4 to 6 :*
 - *Indoor and outdoor units*
 - *Remote control(buttons and display)**They will help you find the buttons and understand the symbols displayed.*

- ◆ *In the manual, you will find a series of step-by-step procedures for each function available.*

The illustrations in the step-by-step procedures use three different symbols:

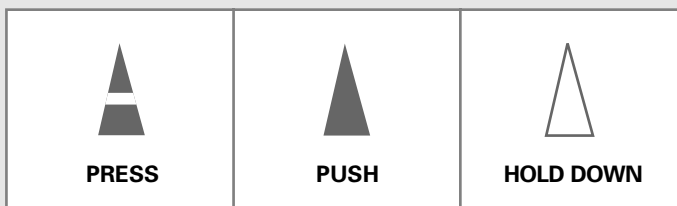

Inserting the Remote Control Batteries

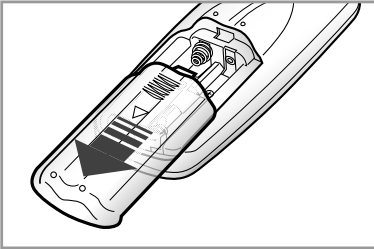

You must insert or replace the remote control batteries when :

- ◆ **You purchase the air conditioner**
- ◆ **The remote control does not work correctly**

Note

- ◆ Use two AAA, LR03 1.5V batteries.
- ◆ Do not use old batteries or different kinds of batteries together.
- ◆ Batteries may be completely discharged after 12 months, even if they have not actually been used.

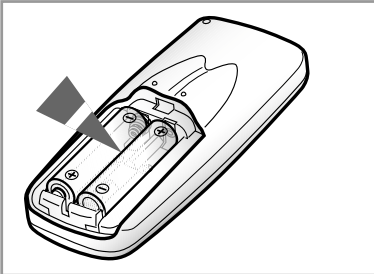

- 1 Push the battery cover on the rear of the remote control with your thumb in the direction of the arrow and remove it.
- 2 Insert the two batteries, taking care to respect the polarities :
 - ◆ + on the battery with + on the remote control.
 - ◆ - on the battery with - on the remote control.
- 3 Close the cover by sliding it back until it clicks into place.

Installing the Remote Control Holder

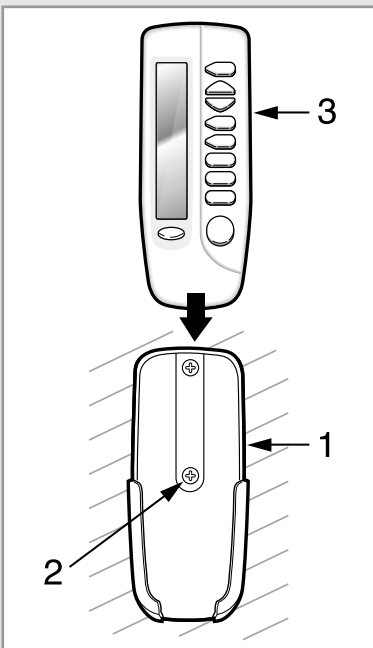







- 1 Place the remote control holder on the wall.
- 2 Fix the remote control holder by tightening the screws.
- 3 Put the remote control into the holder as shown in the figure.
 - ◆ If you want to install the holder easily, you had better install the holder on the wooden frame.

5 Way Function

You can select the 5 Way function with operating mode of the air conditioner for more comfortable circumstances. You can use the 5 Way function with the indoor unit as well as the remote control. Thus, you can use this function even though you have lost your remote control.

Using with the indoor unit

- 1 Press the  (On/Off) button one time and then select the desired mode.

To obtain a(n)...	Then select...
Normal operating	 (STANDARD) mode
Reducing the uncomfortable temperature gradually	 (NATURE) mode
High fan speed	 (POWER) mode
Compressor run time reduced	 (SAVING) mode
Fan speed reduces as the temperature decreases	 (SILENCE) mode

- 2 To stop the operating, press the  (On/Off) button until all indicators turn off.

Note Even if the air conditioner has been turned on via the  (On/Off) button on the unit, operations can still be controlled using the remote control as usual.

Selecting with the Remote Control

To select the 5 Way function with the remote control, press the  button one or more times until the desired mode is selected.

- ◆ Each time you press the  button:



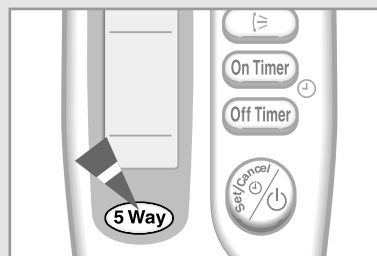
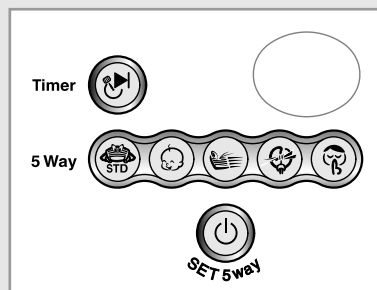

Each 5 Way indicator on the indoor unit lights up in order.

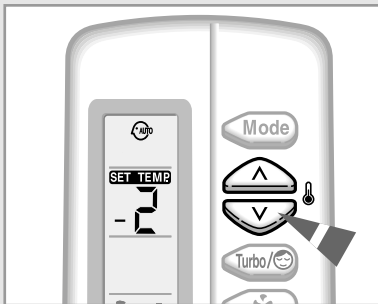
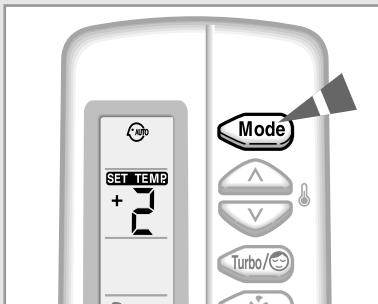
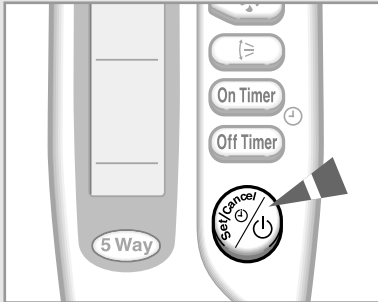

Selecting the Automatic Operating Mode

You can start the air conditioner in Automatic mode from your remote control. In the Automatic mode, the standard temperature and the optimum fan speed is selected automatically. You can adjust the standard temperature but not the fan speed.



- 1 If necessary, press the  (On/Off) button.



Result:

- ◆ The 5 Way indicator on the indoor unit lights up.
- ◆ The air conditioner starts up in the mode selected when the unit was last used.
- ◆ The indoor unit beeps.

IMPORTANT The air conditioner is fitted with a protection mechanism to prevent the unit from being damaged when it is started immediately after being:

- ◆ Plugged in
- ◆ Stopped

It will start up normally after three minutes.

- 2 If the  is not displayed at the top of the remote control, press the  button on the remote control one or more times until it appears.

Result:

- ◆ The indoor unit beeps each time you press the  button.
- ◆ The air conditioner runs in AUTO mode.

Note You can change modes at any time.

- 3 To adjust the standard temperature (The air conditioner automatically set the standard temperature by the current room temperature.), press the  buttons one or more times.

SET TEMP.	SET TEMP.	-	SET TEMP.	SET TEMP.
-4°F	-2°F	Standard temperature	+2°F	+4°F
< When you feel hot >			< When you feel chilly >	

Cooling Your Room

You must select the Cool mode if you wish to adjust the:

- ◆ Cooling temperature
- ◆ Fan speed when cooling

1 If necessary, press the  (On/Off) button.



- Result:**
- ◆ The 5 Way indicator on the indoor unit lights up.
 - ◆ The air conditioner starts up in the mode selected when the unit was last used.
 - ◆ The indoor unit beeps.

IMPORTANT The air conditioner is fitted with a protection mechanism to prevent the unit from being damaged when it is started immediately after being:

- ◆ Plugged in
- ◆ Stopped

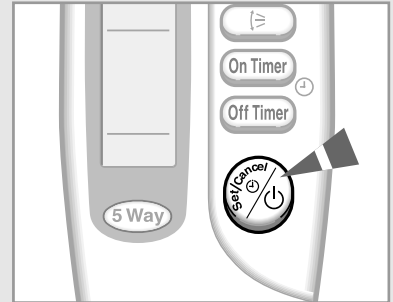
It will start up normally after three minutes.





2 If the  is not displayed at the top of the remote control, press the  button on the remote control one or more times until it appears.

- Result:**
- ◆ The indoor unit beeps each time you press the  button.
 - ◆ The air conditioner runs in COOL mode.

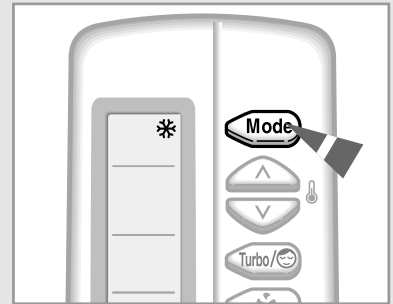
Note You can change modes at any time.







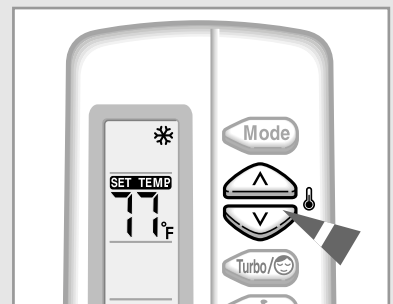

3 To adjust the temperature, press the  buttons one or more times until the required temperature is displayed. Possible temperatures are between 65°F(18°C) and 86°F(30°C) inclusive.

- Result:**
- ◆ Each time you press the  buttons:
 - The temperature is adjusted by 1°F
 - The indoor unit beeps
 - ◆ The air conditioner starts cooling, provided that the room temperature is higher than the selected temperature; the fan will, however, operate.



4 Select the fan speed by pressing the  button one or more times until the required setting is displayed:

-  Automatic (rotated :  →  → )
-  Low
-  Medium
-  High

Result: Each time you press the  button, the indoor unit beeps.

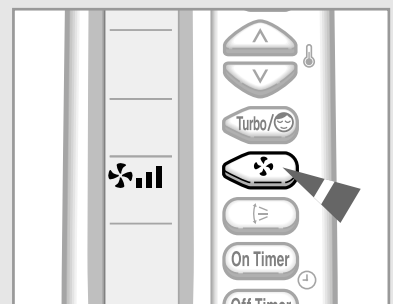

5 To control the direction of the air flow, refer to page 15.

Changing the Room Temperature Quickly

The Turbo cooling function is used to cool your room as quickly as possible.

Example : You have just come home and find that the room is very hot. You wish to cool it down as quickly as possible.

The Turbo function operates for 30 minutes with the maximum settings before returning automatically to the mode and temperature previously selected.

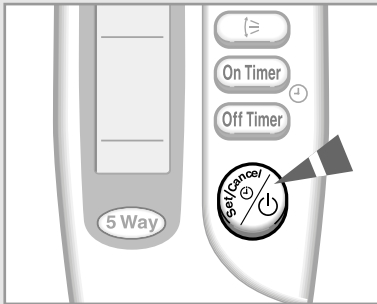

- 1 If necessary, press the  (On/Off) button.

Result:

- ◆ The 5 Way indicator on the indoor unit lights up.
- ◆ The air conditioner starts up in the mode selected when the unit was last used.
- ◆ The indoor unit beeps.

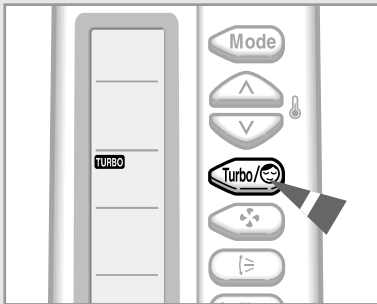



- 2 Press the  button.

Result:

- ◆ The temperature and fan settings are adjusted automatically.
- ◆ The air conditioner cools the room as quickly as possible.
- ◆ After 30 minutes, the air conditioner is reset automatically to the previous mode, temperature and fan settings.

But, if you press the  button in DRY or FAN mode, it will change to AUTO mode automatically.

- 3 If you wish to stop the Turbo function before the end of the 30-minute period, press the  button one or more times until **TURBO** or  disappears.

Result: The air conditioner is reset automatically to the previous mode, temperature and fan settings.

- 4 To control the direction of the air flow, refer to page 15.

Removing Excess Humidity

If the atmosphere in your room is very humid or damp, you can remove excess humidity without lowering the room temperature too much.

- 1 If necessary, press the  (On/Off) button.



Result:

- ◆ The 5 Way indicator on the indoor unit lights up.
- ◆ The air conditioner starts up in the mode selected when the unit was last used.
- ◆ The indoor unit beeps.

IMPORTANT The air conditioner is fitted with a protection mechanism to prevent the unit from being damaged when it is started immediately after being:

- ◆ Plugged in
- ◆ Stopped

It will start up normally after three minutes.

- 2 If the  is not displayed at the top of the remote control, press the  button on the remote control one or more times until it appears.

Result:

- ◆ The indoor unit beeps each time you press the  button.
- ◆ The air conditioner runs in DRY mode.

Note You can change modes at any time.

- 3 To adjust the temperature, press the  buttons one or more times until the required temperature is displayed.

Possible temperatures are between 65°F(18°C) and 86°F(30°C) inclusive.

Result:

- ◆ Each time you press the  buttons:
 - The temperature is adjusted by 1°F
 - The indoor unit beeps
- ◆ The air conditioner starts removing the excess humidity; the quantity of air is adjusted automatically.

- 4 To control the direction of the air flow, refer to page 15.

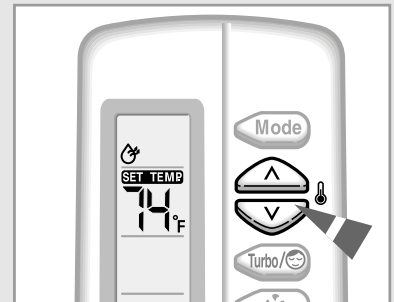
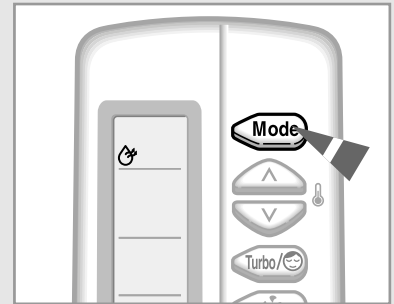
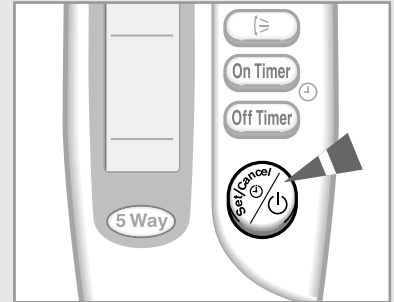

Airing Your Room

If the atmosphere in your room is stale, you can air the room using the Fan feature.

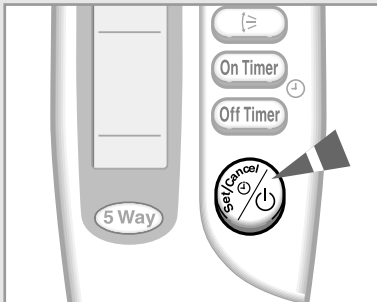



- 1 If necessary, press the  (On/Off) button.

Result:

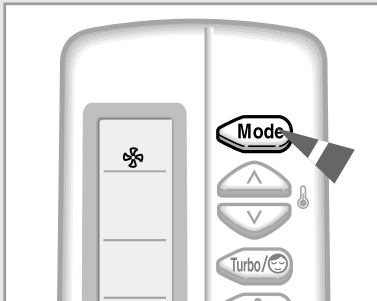
- ◆ The 5 Way indicator on the indoor unit lights up.
- ◆ The air conditioner starts up in the mode selected when the unit was last used.
- ◆ The indoor unit beeps.





- 2 If the  is not displayed at the top of the remote control, press the  button on the remote control one or more times until it appears.

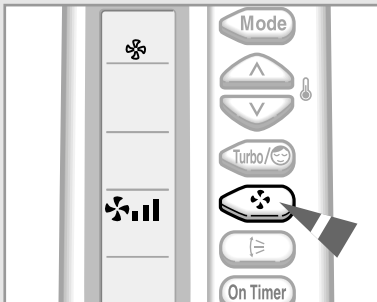

Result:

- ◆ The indoor unit beeps each time you press the  button.
- ◆ The air conditioner runs in FAN mode.
- ◆ The temperature is set automatically.

Note You can change modes at any time.



- 3 Select the fan speed by pressing the  button one or more times until the required setting is displayed:

 Low
 Medium
 High

Result: Each time you press the  button, the indoor unit beeps.

- 4 To control the direction of the air flow, refer to page 15.

Adjusting the Air Flow Direction Vertically

Depending on the position of the indoor unit on the wall of your room, you can adjust the position of the outer air flow blade on the bottom of the unit, thus increasing the efficiency of the air conditioner.

- 1 Press the  button one or more times as required.

Result: The outer blade is adjusted vertically.

RECOMMENDATION	When...	Adjust the blade to face...
	Cooling	Upwards.

- 2 If you want the blade to move up and down automatically when the air conditioner is operating, press the  button.

Result: The blade move up and down, around the base position set.

- 3 To stop the blade moving up and down, press the  button again.

Note *If you switch the air conditioner... Then the blade is...*

Off	Closed completely.
On again	Set to the initial position powered.

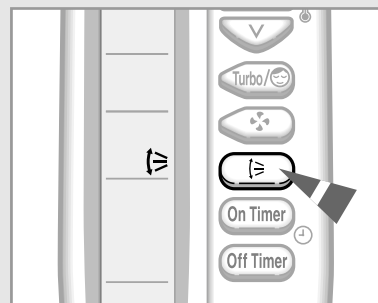

Adjusting the Air Flow Direction Horizontally

There are two sets of inner air flow blades. Just as the outer air flow blade can be adjusted vertically, the inner blades can be adjusted horizontally.

- 1 Adjust each set of inner blades to the required position, by pushing or pulling them sideways.

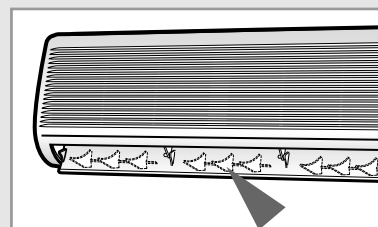

* The design and shape are subject to change according to the model.

Setting the On Timer

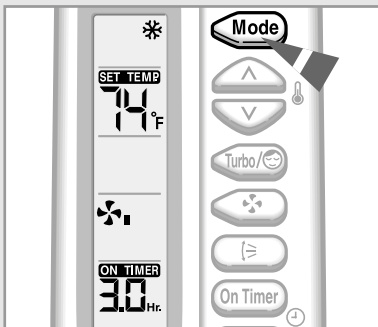
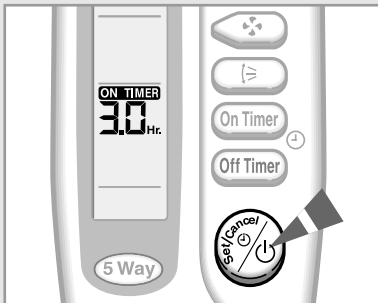
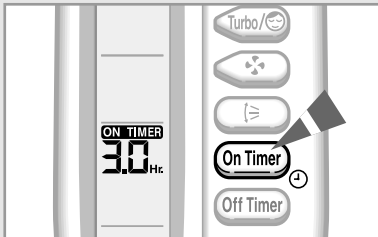

The On Timer enables you to switch on the air conditioner automatically after a given period of time. You can set the period of time from 30 minutes to 24 hours.

1 To set the operating time, press the **On Timer** button one or more times until the required time is displayed. Possible time is between 0.5 hour and 24 hour inclusive.

2 Press the **Set/Cancel** button to complete the setting.

Result:

- ◆ The remaining time is displayed.
- ◆ Blinking of the timer indicator stops.
- ◆ The selected mode and the temperature on the display disappear after 10 seconds.
- ◆ The air conditioner will switch on automatically when the counter displayed on the remote control reaches the set time and disappears the On timer setting.

3 To select an operating mode in advance, press the **Mode** button until the desired mode is displayed at the top of the remote control.

Result:

- ◆ The air conditioner will run in the selected mode when it is turned on.

To Cancel the On Timer

1 To cancel the On Timer, press the **On Timer** button one or more times until the timer setting disappears.

2 Press the **Set/Cancel** button.

Note

If you want to turn on the air conditioner before the timer reaches the setting time, press the **On/Off** button.

Setting the Off Timer

The Off Timer enables you to switch off the air conditioner automatically after a given period of time. You can set the period of time from 30 minutes to 24 hours.





- 1 To set the operating time, press the  button one or more times until the required time is displayed. Possible time is between 0.5 hour and 24 hour inclusive.



- 2 Press the  (Set/Cancel) button to complete the setting.

Result:

- ◆ The remaining time is displayed.
- ◆ Blinking of the timer indicator stops.
- ◆ The air conditioner will switch off automatically when the counter displayed on the remote control reaches the set time and disappears the Off timer setting.

Example If you would like to turn the air conditioner on after 2 hours and to operate it for 2 hours:

1. Press the  button until '2.0 Hr' is displayed.
2. Press the  (Set/Cancel) button.
3. Press the  button until '4.0 Hr' is displayed.
4. Press the  (Set/Cancel) button.

Note You can see or change the setting mode and/or the temperature by pressing the  button or the  buttons after setting the Off timer.

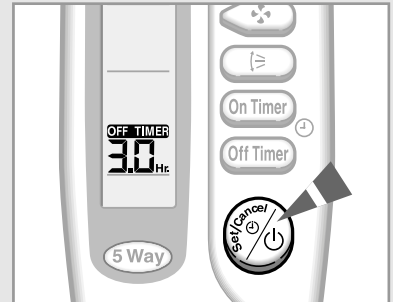
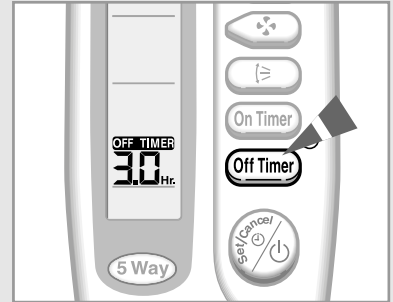

To Cancel the Off Timer

- 1 To cancel the Off Timer, press the  button one or more times until the timer setting disappears.

- 2 Press the  (Set/Cancel) button.

Note If you want to turn off the air conditioner before the timer reaches the setting time, press the  (On/Off) button.

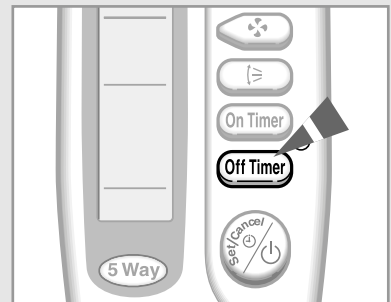



Setting the Sleep Timer

The Sleep Timer can be used when you are cooling your room to switch the air conditioner off automatically after a period of six hours.

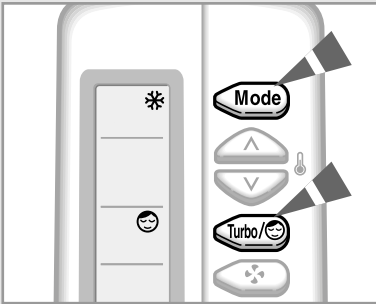
Note If you wish to switch the unit off at a specific time, refer to page 17.



1 Make sure that you have selected either COOL mode.

2 Press the  button one or more times until  appears on the remote control.

Result:

- ◆ The indoor unit beeps.
- ◆ The air conditioner will be controlled as indicated in the illustrations below.

Cooling The desired temperature is increased by 2°F every hour. When it has been increased by 4°F (after two hours), the temperature is maintained for four hours.

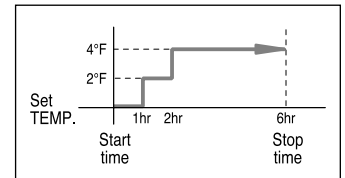

To Cancel the Sleep Timer

If you no longer wish to use the Sleep Timer that you have set, you can cancel it at any time.

Press the  button.

Result:

- ◆ The indoor unit beeps.
- ◆ The  is no longer displayed.
- ◆ The air conditioner operates normally.

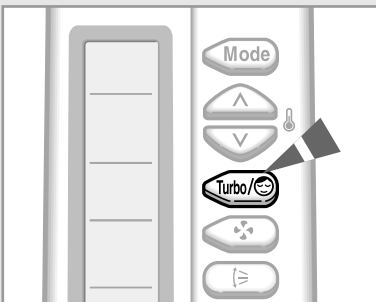

Operating Recommendations

Here are a few recommendations that you should follow when using your air conditioner.

Topic	Recommendation
Power failure	<p>If a power failure occurs when the air conditioner is operating, the unit is switched off. When the power returns,</p> <hr/> <p> **A1** **A5** you must press the  (On/Off) **A9** button to restart it. **AA** </p> <hr/> <p> **A0** **A2** the air conditioner starts up **A6** again automatically **AB** </p>

Note Be sure which model you have purchased because some air conditioners do not restart automatically.

Temperature and Humidity Ranges

The following table indicates the temperature and humidity ranges within which the air conditioner can be used.

If the air conditioner is used at...	Then...
High temperatures	The automatic protection feature may be triggered and the air conditioner stopped.
Low temperatures	A water leak or some other malfunction may occur if the heat exchanger freezes.
High humidity levels	Water may condense on and drip from the surface of the indoor unit if it is used for long periods.

Mode	Outdoor Temperature	Indoor Temperature	Indoor Humidity
Cooling	70°F to 109°F approx. 21°C to 43°C approx.	65°F to 90°F approx. 18°C to 32°C approx.	80% or less
Drying	65°F to 109°F approx. 18°C to 43°C approx.	65°F to 90°F approx. 18°C to 32°C approx.	-

※ ***If the cooling operation is used at over 92°F/33°C (indoor temperature), it does not cool as its full capacity.***

Cleaning Your Air Conditioner

To get the best possible use out of your air conditioner, you must clean it regularly to remove the dust that accumulates on the air filter.

IMPORTANT Before cleaning your air conditioner, ensure that you have switched off the breaker used for the unit.

- 1 Open the front grille by pulling on the tabs on the lower right and left sides of the indoor unit.
- 2 ****07/09/12****
Disassemble the front grille by pulling it forwards.
Note ****18/24**** models are not included.
- 3 ****07/09/12****
Hold the edge of the air filter under the front grille and pull to release them.
****18/24****
Lift out the bottom edge of the air filters and pull down to release them.
- 4 Remove all dust on the air filters with a vacuum cleaner or brush.
- 5 Clean the front panel with a damp cloth and mild detergent (do NOT use benzene, solvents or other chemicals).
- 6 ****18/24****
When you have finished, insert the top part of the filters into their slot and push down on the bottom edge until they click into place.
Note ****07/09/12**** models are not included.
- 7 Reassemble the air filters and the front grille.

- Note**
- ◆ **If you have not used the air conditioner for a long period of time, set the fan going for three to four hours to dry the inside of the air conditioner thoroughly.**
 - ◆ **Clean the air filter twice a month. It is recommendable to clean the air filter more often if your room has heavy dusts.**

****07/09/12****

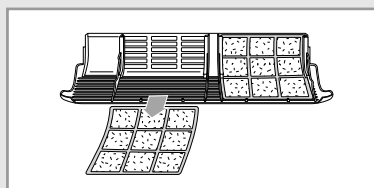
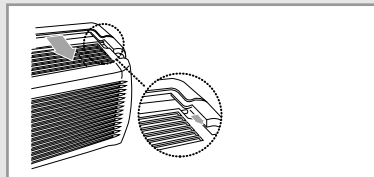



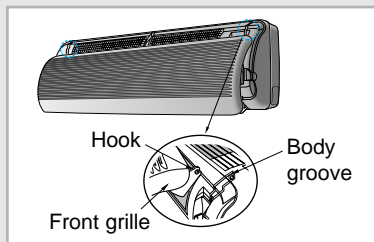
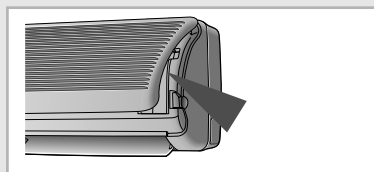

****18/24****



Solving Common Problems

Before contacting the after-sales service, perform the following simple checks. They may save you the time and expense of an unnecessary call.

Problem	Explanation/Solution
The air conditioner does not operate at all	<ul style="list-style-type: none"> ◆ Check that the breaker used for the air conditioner is switched on. ◆ Check that the 5 Way indicator on the indoor unit is on; if necessary press the  (On/Off) button on the remote control. ◆ Check whether the TIMER indicator on the indoor unit is switched on. If so: <ul style="list-style-type: none"> - Wait until the switch-on time is reached and the air conditioner starts up automatically - Cancel the timer (see pages 16 and 17 for further details)
The air conditioner does not operate with the remote control	<ul style="list-style-type: none"> ◆ Check that there are no obstacles between you and the indoor unit. ◆ Check the remote control batteries. ◆ Check that you are close enough to the indoor unit [23ft(7m) or less].
No beep is heard when you press the  (On/Off) on the remote control	<ul style="list-style-type: none"> ◆ Check that you are pointing the remote control at the remote control sensor in the right of the indoor unit. ◆ Replace the remote control batteries if necessary.
The air conditioner does not cool	<ul style="list-style-type: none"> ◆ Check that the correct operating mode has been selected (AUTO, COOL). ◆ The room temperature may be too low or too high. ◆ Dust may be blocking the air filter guard; refer to page 21 for cleaning instructions. ◆ Check that there is no obstacle in front of the outdoor unit.
The fan speed does not change when you press the  button	<ul style="list-style-type: none"> ◆ Check that the operating mode is set to COOL or FAN ; in the AUTO mode, the fan speed changes automatically and in the DRY mode, it is set to AUTO.
The air flow direction does not change when you press the  button	<ul style="list-style-type: none"> ◆ Check that the air conditioner has been switched on; if necessary, press the  (On/Off) button on the remote control.
The timer is not correctly triggered	<ul style="list-style-type: none"> ◆ Check that the timer has been programmed correctly; see pages 16 and 17.
Odours are permeated in the room during air conditioning	<ul style="list-style-type: none"> ◆ Air the room.

Installing a Filter (Option)

The air conditioner can be fitted with a deodorizing and Bio-Pure filter to remove minute dust particles or odours. The service life of the filter is approximately three months depending on the time during which the air conditioner is used.

- 1 Remove the vinyl packing from the filter.

Note Do not remove the packing from a deodorizing filter until you wish to use the filter, as it will lose its properties.

- 2 Insert the filter in the filter holder and press the three insert tabs until you hear a click.

- 3 Open the front grille by pulling on the tabs on the lower right and left sides of the indoor unit.

- 4 Take out the existing filter and replace it with the new one.

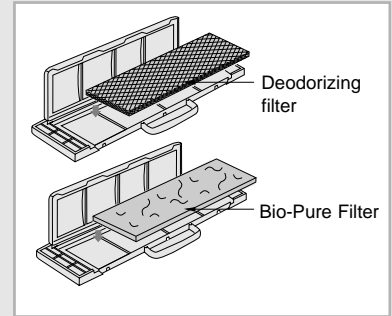

Technical Specifications

MODEL		AS07A5(6)MA	AS09A5(6)MAF	AS12AA(B)MCF	
Performance Ratings	Capacity Cooling	Btu/h	7500	9000	11500
	SEER		10.0	10.0	10.0
	Moisture Removal	Pts/h	2.5	3	4
	Air FLOW(Cooling, HIGH)	CFM	214	230	261
	Sound Rating-Outdoor	dB	50	51	55
Electrical Data	Power source		115V~, 60Hz	115V~, 60Hz	208-230V~, 60Hz
	Min.Ampacity	A	6.4	8.1	5.4
	Cooling Watts	W	680	950	1230
Refrigeration Lines	Connections		Flare	Flare	Flare
	Liquid Line O. D.	inch(mm)	$\frac{1}{4}$ (6.35)	$\frac{1}{4}$ (6.35)	$\frac{1}{4}$ (6.35)
	Suction Line O.D.	inch(mm)	$\frac{3}{8}$ (9.52)	$\frac{3}{8}$ (9.52)	$\frac{1}{2}$ (12.70)
	Factory Pre-charge	ft(m)	16 $\frac{1}{2}$ (5.0)	24 $\frac{3}{4}$ (7.5)	24 $\frac{3}{4}$ (7.5)
	Max. Line length	ft(m)	49 $\frac{1}{4}$ (15.0)	49 $\frac{1}{4}$ (15.0)	49 $\frac{1}{4}$ (15.0)
	Max. Height Difference	ft(m)	23(7.0)	23(7.0)	23(7.0)
Dimensions & Weight	INDOOR UNIT		AS07A5(6)MA	AS09A5(6)MAF	AS12AA(B)MCF
	W x H x D	inch(mm)	31 $\frac{1}{8}$ x 9 $\frac{1}{2}$ x 6 $\frac{1}{2}$ (790 x 245 x 165)	31 $\frac{1}{8}$ x 9 $\frac{1}{2}$ x 6 $\frac{1}{2}$ (790 x 245 x 165)	31 $\frac{1}{8}$ x 9 $\frac{1}{2}$ x 6 $\frac{1}{2}$ (790 x 245 x 165)
	Net Weight	lbs(kg)	21.2(9.6)	21.2(9.6)	21.2(9.6)
	OUTDOOR UNIT		US07A5(6)MA	US09A5(6)MAF	US12AA(B)MCF
	W x H x D	inch(mm)	26 x 19 $\frac{1}{2}$ x 9 $\frac{1}{4}$ (660 x 497 x 235)	26 x 19 $\frac{1}{2}$ x 9 $\frac{1}{4}$ (660 x 497 x 235)	29 x 20 $\frac{3}{4}$ x 9 (740 x 530 x 230)
	Net Weight	lbs(kg)	60.7(27)	61.7(27.4)	71.5(32)

* Standard rating conditions Cooling

	Indoor		Outdoor	
	DB	WB	DB	WB
°F	80	67	95	75
°C	26.7	19.4	35.0	23.9

MODEL			AS18A9(0)RCF/AS18A9(0)RCFD	AS24A1(2)RC/AS24A1(2)RCD
Performance Ratings	Capacity Cooling	Btu/h	18000	23500
	SEER		10.0	10.0
	Moisture Removal	Pts/h	4.9	5.4
	Air FLOW(Cooling, HIGH)	CFM	456	477
	Sound Rating-Outdoor	dB	57	59
Electrical Data	Power source		208-230V~, 60Hz	208-230V~, 60Hz
	Min.Ampacity	A	8.0	10.5
	Cooling Watts	W	1770	2350
Refrigeration Lines	Connections		Flare	Flare
	Liquid Line O. D.	inch(mm)	$\frac{1}{4}$ (6.35)	$\frac{1}{4}$ (6.35)
	Suction Line O.D.	inch(mm)	$\frac{1}{2}$ (12.70)	$\frac{5}{8}$ (15.88)
	Factory Pre-charge	ft(m)	24 $\frac{3}{4}$ (7.5)	16 $\frac{1}{2}$ (5.0)
	Max. Line length	ft(m)	49 $\frac{1}{4}$ (15.0)	65 $\frac{1}{2}$ (20.0)
	Max. Height Difference	ft(m)	23(7.0)	26 $\frac{1}{4}$ (8.0)
Dimensions & Weight	INDOOR UNIT		AS18A9(0)RCF/AS18A9(0)RCFD	AS24A1(2)RC/AS24A1(2)RCD
	W x H x D	inch(mm)	42 $\frac{1}{2}$ x 11 x 8 (1080 x 275 x 204)	42 $\frac{1}{2}$ x 11 x 8 (1080 x 275 x 204)
	Net Weight	lbs(kg)	29.7(13.4)	29.7(13.4)
	OUTDOOR UNIT		US18A9(0)RCF/US18A9(0)RCFD	US24A1(2)RC/US24A1(2)RCD
	W x H x D	inch(mm)	31 x 24 $\frac{3}{8}$ x 12 $\frac{5}{8}$ (787 x 620 x 320)	34 $\frac{5}{8}$ x 25 $\frac{1}{8}$ x 12 $\frac{1}{4}$ (880 x 638 x 310)
	Net Weight	lbs(kg)	98.1(44)	138.9(62)

**THIS AIR CONDITIONER IS MANUFACTURED BY:
ESTE AIRE ACONDICIONADO HA SIDO FABRICADO POR:
CE CLIMATISEUR EST FABRIQUE PAR:**



ELECTRONICS