

Sunbeam

Mixmaster Professional

Twin-motor benchtop mixer

Instruction Booklet
MX8800

Please read these instructions carefully
and retain for future reference.



Contents

Sunbeam's Safety Precautions	1
Features of your Mixmaster Professional	2
Using your Mixmaster Professional	4
Role of the Twin-Motor	
3-Way Beating Action	7
Mixing Guide	8
Oven Temperature Guide	9
Care and Cleaning of your Mixmaster Professional	10
Lets Talk Ingredients	11
Cookery Tips for Best Results	13
Helpful Hints for a Successful Dough	14
Helpful Hints for Better Cake Making	16
Recipes	18

Important instructions – retain for future use.

تأكد من تفهم احتياطات السلامة المذكورة اعلاه

請務必理解上述的安全預防措施。

Assurez-vous que les précautions ci-dessus relatives à la sécurité sont bien comprises

Versichern Sie sich daß die obenstehenden Sicherheitsmaßnahmen Verstanden werden

Βεβαιώνετε πως οι παραπάνω προφυλάξεις ασφαλείας γίνονται κατανοητές

Pastikan bahwa tindakan-tindakan keselamatan seperti di atas dimengerti anda

Accertatevi che le suddette norme di sicurezza siano comprese a dovere

上記の注意事項をよくお読みになり、安全を御確認ください

Уверете се дека погоре споменатите мерки на претпазливост се добро разбрани

Asegúrese de que las precauciones de seguridad precedentes sean bien comprendidas

کاری یکنید کہ احتیاط‌های بالا حتماً درک بشوند

ต้องแน่ใจว่า ข้อควรระวังเรื่องความปลอดภัยข้างต้น เป็นที่เข้าใจกันดี

Yukarda belirtilen güvenlik önlemlerinin anlaşılığından emin olunuz

Xin kiểm chắc rằng những biện pháp làm an toàn kể trên được hiểu rõ

Sunbeam's Safety Precautions

SAFETY PRECAUTIONS FOR YOUR SUNBEAM MIXMASTER.

- Never eject beaters, dough hooks or whisks when the appliance is in operation.
- Ensure fingers are kept well away from moving beaters, whisks and dough hooks.
- Ensure that the bowl is secured and locked onto the base of the Mixmaster before commencing mixing.
- Do not unlock or remove the mixing bowl from the base of the Mixmaster whilst mixer is in use.

Sunbeam are very safety conscious when designing and manufacturing consumer products, but it is essential that the product user also exercise care when using an electrical appliance. Listed below are precautions which are essential for the safe use of an electrical appliance:

- Read carefully and save all the instructions provided with an appliance.
- Always turn the power off at the power outlet before you insert or remove a plug. Remove by grasping the plug - do not pull on the cord.
- Turn the power off and remove the plug when the appliance is not in use and before cleaning.
- Do not use your appliance with an extension cord unless this cord has been checked and tested by a qualified technician or service person.
- Always use your appliance from a power outlet of the voltage (A.C. only) marked on the appliance.
- Close supervision is necessary when your appliance is being used near children or infirm persons.
- Never leave an appliance unattended while in use.
- Young children should be supervised to ensure that they do not play with the appliance.

- Should you be using a spatula during mixing, ensure that the spatula is kept well away from moving beaters, whisks and dough hooks.
- Never tilt back the head of the Mixmaster whilst the appliance is in operation.
- When using extremely heavy loads the appliance should not be operated for more than 1 minute. This does not apply to the recipes detailed in this booklet.

- Do not use an appliance for any purpose other than its intended use.
- Do not place an appliance on or near a hot gas flame, electric element or on a heated oven. Do not place on top of any other appliance.
- Do not let the power cord of an appliance hang over the edge of a table or bench top or touch any hot surface.
- For safety reasons and to avoid maintenance by unskilled persons, some appliances are 'sealed' using tamperproof screws. Such appliances should always be returned to the nearest Sunbeam Appointed Service Centre for adjustment or repair if required.
- Do not operate any electrical appliance with a damaged cord or after the appliance has been dropped or damaged in any manner. If damage is suspected, return the appliance to the nearest Sunbeam Appointed Service Centre for examination, repair or adjustment.
- For additional protection, Sunbeam recommend the use of a residual current device (RCD) with a tripping current not exceeding 30mA in the electrical circuit supplying power to your appliances.
- Do not immerse the appliance in water or any other liquid unless recommended.

If you have any concerns regarding the performance and use of your appliance, please visit www.sunbeam.com.au or contact the Sunbeam Consumer Service Line. Ensure the above safety precautions are understood.

Features of your Sunbeam Mixmaster Professional

Attachment eject button

The eject button, located on the top of the handle releases the beaters, dough hooks or whisks for easy cleaning.

Twin-motor 3-way beating action

Patent pending twin-motor design enables one motor to drive the beaters, each turning in opposite directions. The second motor drives the bowl, thus combined, this new technology results in a more powerful and thorough mixing result.

Variable bowl speed

The bowl speed increases and decreases automatically as the beater speed is increased and decreased.

Off-centre head & beaters

The head of the Mixmaster and beaters are positioned off-centre to the bowl to make it easier to add ingredients during mixing.

Tilt back locking head

The head of the Mixmaster tilts back and locks securely into position to allow easy removal of mixing bowls and attachments.

Bowl selector

Simply slide the bowl selector lever to the left when using the small bowl and to the right when using the large bowl.

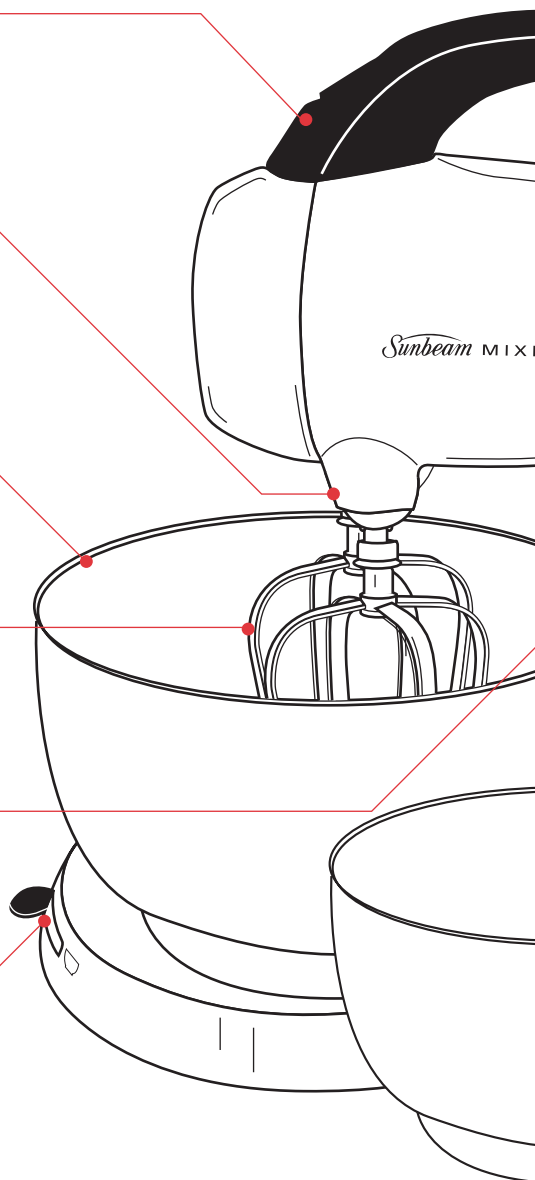

MASTER
PROFESSIONAL

- 1 Scones - Pastry
- 2 Biscuit Dough
- 3 Tea Cakes
- 4 Sauces & Puddings
- 5 Custard - Icing
- 6 Pastry Mixer

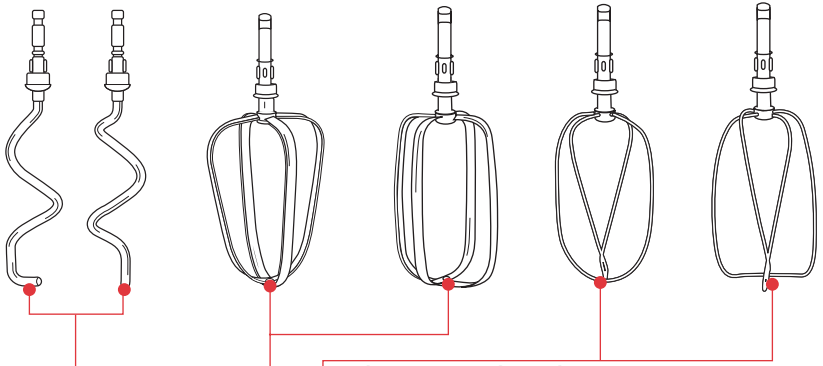

Stainless steel wire whisks

For whisking cream, egg whites, light batters and packet cake mixes.

Stainless steel 'V-groove' beaters

Heavy duty 'V-groove' beaters for creaming butter and sugar, plus mixing heavy cake mixes.

Stainless steel dough hooks

Heavy duty dough hooks take the hard work out of kneading dough and other heavy mixtures.

12 electronic speeds

The combination of 12 electronic speeds and a powerful torque control motor ensures superior mixing control and maintains speed regardless of the mixing load.

Stainless steel mixing bowls

4.4 and 2.1 litre mixing bowls are ideal for mixing large or small quantities of ingredients.

Die-cast metal body

The heavy duty die-cast metal body combined with non-slip rubber feet keep the Mixmaster stable during operation.

Using your Sunbeam Mixmaster Professional

Before using your Mixmaster Professional

Before assembling your Mixmaster, be sure the power cord is unplugged from the power outlet and the speed control dial is in the 'Off' position.

1. Press the 'tilt' button, located at the top of the neck of the Mixmaster Professional. While the button is depressed, hold the handle (1) and ease the head of the Mixmaster back. The Mixmaster head will lock into this tilt position (2).

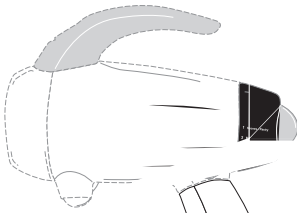
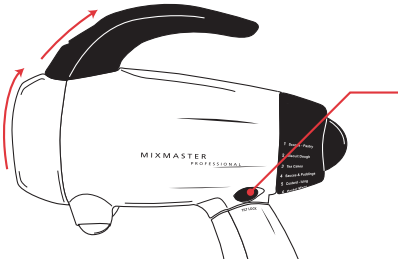

2. Select the desired attachments depending on the mixing task to be performed;
 - Beaters for creaming butter and sugar, plus mixing heavy cake mixes.
 - Whisks for whisking cream, egg whites, light batters and packet cake mixes.
 - Dough hooks for kneading dough and other heavy mixtures.

3. Insert selected attachment;

Beaters – select the two beaters.

Take the beater that has a pointier, curved bottom and has a red coloured band around the top of the beater – illustrated as beater (A). Insert beater (A) into the left hole on the underside of the mixer head, the hole is identified by a red dot beside it (3).

Take the beater with the angular/flat bottom, illustrated as beater (B) into the remaining hole.

Note: Be sure both beaters are in place, you may need to push them slightly to engage them.

band around the top of the whisk – illustrated as whisk (A). Insert whisk (A) into the left hole on the underside of the mixer head, the hole is identified by a red dot beside it (4).

Take the whisk with the angular/flat bottom, illustrated as whisk (B) and insert into the remaining hole.

Note: Be sure both whisks click firmly in place, you may need to twist the whisk slightly to engage it in position prior to pushing it in place.

Using your Sunbeam Mixmaster Professional continued

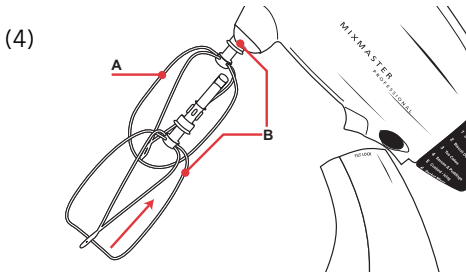

Dough hooks – select the two dough hooks. Take the dough hook that is hooked at the bottom and has a red coloured band around the top of the dough hook – illustrated as dough hook (A). Insert dough hook (A) into the left hole on the underside of the mixer head, the hole is identified by a red dot beside it (5).



Take the dough hook that is straight at the bottom, illustrated as dough hook (B) and insert into the remaining hole.

Note: Be sure both dough hooks click firmly in place, you may need to twist the dough hook slightly to engage it in position prior to pushing it in place.

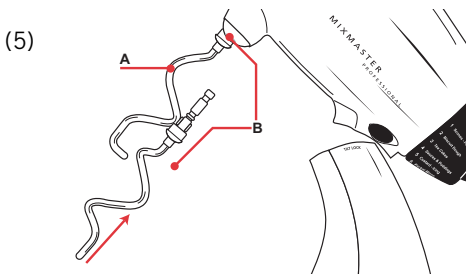

Important: These attachments have been designed with a safety feature so that they cannot be put in, in the incorrect way.

4. Depending on the amount of ingredients required for mixing, select bowl size. If you have selected the large 4.4 litre bowl, slide the bowl selector to the far right (6a). If you have selected the smaller 2.1 litre bowl, slide the bowl selector to the far left (6b).

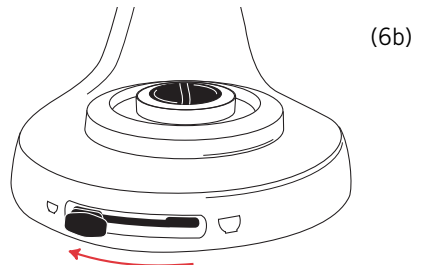
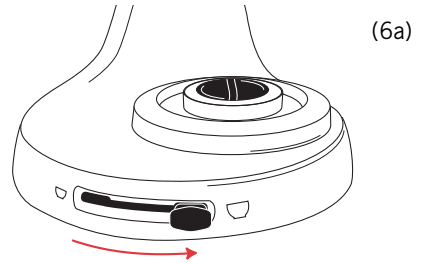

5. Once you have selected the bowl you wish to use, place it on the rotating base. Gently rotate the bowl in an anti-clockwise direction until it drops into position or is sitting flat (a). Then rotate the bowl clockwise to lock it into position (b). The bowl should feel firm with no movement (7).

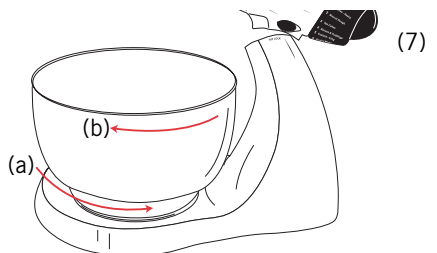

(9)



(11)

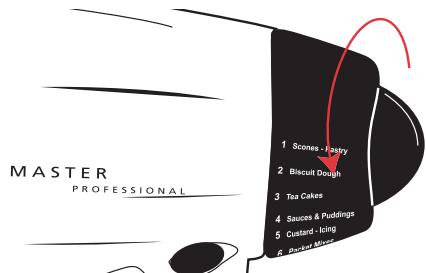

Using your Sunbeam Mixmaster Professional continued

4. Hold down the 'tilt' button and ease the head of the Mixmaster back until the mixer head is locked into the tilt back position (see diagrams 1 and 2 on page 4).
5. To remove the particular attachments (either beaters, whisks or dough hooks) place fingers loosely around the attachments and press the eject button located at the front of the handle (12).

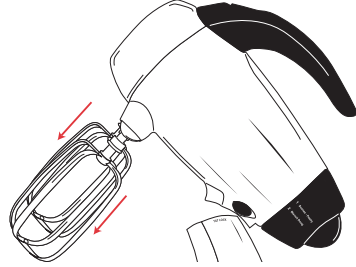

Role of the Twin-Motor 3-Way Beating Action

Sunbeam launched its 3-way beating action in the late 1920s which revolutionised mixing at the turn of a dial. The 3-way beating action is determined by each of the two beaters turning against each other, plus then the bowl also rotating.

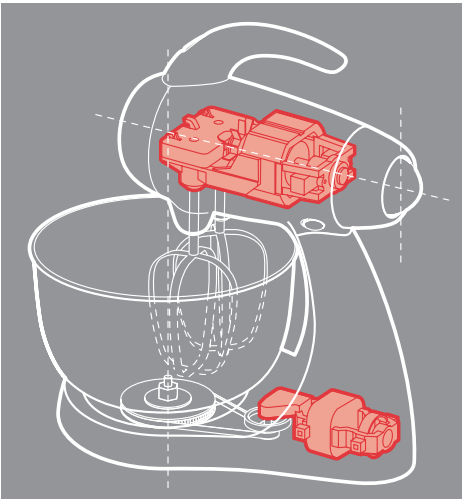

Our latest innovation of this historic 3-way beating action has been the introduction of an additional motor into the design. One motor is located in the head of the Mixmaster. This drives the individual beaters, turning each in opposite directions.

The second motor is located in the base of the neck of the Mixmaster and drives the turntable, in turn rotating the bowl against the direction of the outside beater. The speed of the bowl rotation is automatically determined depending on the mixing speed selected.

Therefore as the mixing speed increases so does the speed of the bowl, and as the mixing speed is decreased, the bowl speed also slows.

These actions combine to ensure a more powerful and thorough mixing result.

This twin-motor design is patent pending.

Mixing Guide

Please keep in mind that the various mixing tasks and related speeds, listed in the table below, may vary slightly from recipe to recipe.

Please refer to it regularly as you develop your understanding of how different ingredients interact when mixing.

SPEED SETTING RANGE	MIXING TASK
LOW 1-3	FOLDING & KNEADING Folding Kneading – doughs (pastry, bread, scones)
MEDIUM 4-6	LIGHT MIXING Kneading - heavy doughs (large quantities) Beating – packet mixes Beating – creaming sugar and butter
HIGH 7-9	CREAMING & BEATING Whisking – light batters Beating – cake mixes/heavy batters/icings
VERY HIGH 10-12	WHIPPING & AERATING Whisking – egg whites/cream

NOTES:

For most recipes, it is better to begin your mixing on a slower speed until the ingredients begin combining, then move to the appropriate speed range for the particular task.

Generally there is no one set speed for an entire recipe. You will need to change the speed of the Mixmaster depending on what stage of the recipe you are working on. This is communicated in the recipe section.

When mixing larger quantities you may need to increase the Mixmaster speed due to the amount of mixing required and the larger load on the machine.

When building up a recipe that requires the addition of dry ingredients, such as flour, slow the speed down whilst these ingredients are being added to avoid a snow storm effect. Once the extra ingredients begin combining then slowly increase to the appropriate speed for the particular mixing task.

Oven Temperature Guide

For your information, the following temperature settings are included as a guide. These settings may need to be adjusted to suit the individual range.

Thermostat Settings				
Description of Oven Temperatures	Electric		Gas	
	°C	°F	°C	°C
Cool	200	110	200	100
Very Slow	250	120	250	120
Slow	300	150	300	150
Moderately Slow	350	170	325	160
Moderate	400	200	350	180
Moderately Hot	425	220	375	190
Hot 450	230	400	200	
Very Hot	475	250	450	230

Note: If using fan forced ovens be sure to turn the temperature down by 20-30°C.
Also check recipes at the back of this book.

Care and Cleaning

Before cleaning your Sunbeam Mixmaster, ensure that the power is turned 'Off' at the power outlet, then remove the plug.

Wipe over the outside area of the Mixmaster including the head and base, with a dampened cloth and polish with a soft dry cloth.

Wipe any excess food particles from the power cord.

Wash the mixing bowls, beaters, whisks and dough hooks in warm soapy water and wipe dry - use a brush if necessary to remove any sticky food particles. The stainless steel mixing bowls, beaters, whisks and dough hooks may be washed in the dishwasher.

The turntable can be removed for thorough cleaning. This should be done occasionally to keep your Mixmaster clean.

Maintenance Service

Your Sunbeam Mixmaster should be regularly checked. After approximately four years of domestic use, the grease in the gear compartment should be examined. We suggest at that time you send the Mixmaster to your nearest Sunbeam Appliance Service Centre to ensure efficient, correct servicing.

Storage

Keep your Sunbeam Mixmaster in a convenient position on your kitchen bench ready for use at all times. Place the beaters, whisks and dough hooks in the mixing bowl as storage of these attachments in a drawer with other kitchen equipment may cause damage.

Note: Never wind the power cord around the Mixmaster after use as the warmth from the motor may cause damage to the power cord.

Lets Talk Ingredients

Listed below is a guide regarding some of the ingredients used in the recipes in this book.

Shortenings

The word, shortening, is a term used to describe any one of the solid fats (animal, vegetable or a mixture) which is suitable for general use. Some are more suited than others for particular recipes and are therefore specified. Where the term shortening is used, select the one most pleasing to your palate. It is possible to mix or substitute according to your requirements. Examples include; Cotton seed oil and soybean.

Butter

Butter is made from approximately 80% milk fat (cream) and is churned over a period of time to produce a solid (butter). Butter is used to stabilize, texturize and add flavour. Butter may be salted or unsalted, it is best to use unsalted butter for cake baking. Clarified butter has the milk solids and salt removed, which is ideal for pastry making as it can be heated to higher temperatures than regular butter.

Note: Margarine can be used as a substitute for butter. It is made from vegetable oils, therefore it may alter the end result. There are various types of margarines, some of these are butter-margarine blends and fat reduced.

Yeast

A raising agent used in doughs. Yeast is a microscopic living organism that grows rapidly in suitable warm, moist conditions. The yeast plant feeds on sugar and expels carbon dioxide which expands the gluten framework. When foaming yeast do not allow the temperature to exceed 46°C, as this prevents killing the yeast. A 26°C - 30°C, draft free area is most suitable for the growth

of yeast during the rising process. Both Dry Yeasts and fresh Compressed Yeast may be used in the recipes included in this book. (NB. 7g of dry yeast is equivalent to 15g of compressed yeast).

Substitutes

If you find it necessary to substitute ingredients in a recipe, check the following alternatives:

1 cup S.R. flour = 1 cup plain flour and 2 teaspoons baking powder.

1 cup plain flour and 1 teaspoon baking powder = 1/2 cup each of plain and S.R. flour.

1 tablespoon arrowroot = 1 tablespoon cornflour.

Sultanas = equal measure of any other dried fruit.

Golden Syrup = equal measure of honey or treacle.

1 cup sour milk = 1 cup fresh milk and 2 teaspoons vinegar or lemon juice.

Measuring Ingredients

Careful and correct measurement of all ingredients is essential for recipe success. Australian Standard Metric cup and spoon measures are used in all recipes in the book. All cup and spoon measurements should be level.

The following are some hints on measuring ingredients.

Wet Ingredients

Place the measuring jug on a level surface and check the measurement at eye level.

Dry ingredients

Use a standard metric measuring cup and spoon to measure out dry ingredients. After filling, level off cup or spoon with a knife.

Lets Talk Ingredients continued

You may like to tap the cup or spoon on kitchen benchtop before levelling. If your dry ingredients has any lumps, be sure to remove them or break them up, sifting ingredients prior to mixing will help.

Raising Agents

Care is essential for best results. Check for and crush any lumps, particularly in bicarbonate of soda, before measuring.

Cheese and Breadcrumbs

Pack grated cheese and soft breadcrumbs into the cup pressing lightly to obtain best results.

Fats and Oils

The simplest method to measure butters, margarines and shorting is to cut or spoon the required amount from the block or container and then weigh it using metric scales.

Cookery Tips for Best Results

1. Before starting, read the recipe completely.
2. Refrigerated ingredients, ie butter and eggs should be at room temperature before mixing begins. Set these ingredients out ahead of time.
3. Before starting your recipe preheat oven to baking temperature recommended in the recipe.
4. Assemble all ingredients and utensils near the mixer.
5. To eliminate the possibility of shells or deteriorated/off eggs in your recipe, break eggs into a separate container first, then add to the mixture.
6. When mixing egg whites, be sure the bowls and beaters are thoroughly cleaned and dried. As even the smallest amount of oil on beaters or bowl may cause the egg whites not to aerate.
7. Always start mixing at slow speeds. Gradually increase to the recommended speed as stated in the recipe.
8. Do not overbeat. Be careful that you only mix/blend mixtures until recommended in your recipe. Fold in dry ingredients only until just combined. Always use the low speed. At any stage of mixing, over beating can cause toughness, close texture, lack of rising or excessive shrinkage. Climatic conditions, seasonal temperature changes, temperature of ingredients and their texture variation from area to area all play a part in the required mixing time and the results achieved.
9. All recipes have been kitchen tested, but should you find it necessary to vary the ingredients or the size of the tin etc. allow for a variation in cooking time. Always test for doneness in baked foods before removing from the oven or the cooking appliance.

Helpful Hints for a Successful Dough

Step 1: Preparing the yeast

For the dry yeast to be activated it needs to ferment. To do this place warm milk, sugar and the tepid water into a bowl, add dry yeast and mix. Stand in a warm place until mixture starts foaming ie bubbles. This process will take approximately 10 minutes. Be sure not to overheat the milk. As hot temperatures will kill and deactivate the yeast.

Step 2: Preparing the dough

Note: Ensure dough hooks are in place (refer to page 5).

1. Place the dry ingredients into the Mixmaster bowl and attach onto the base. Turn the speed control dial to speed 1 and begin to gradually add the liquid ingredients to the bowl.

Note: You may find it useful to use a rubber or plastic spatula to scrape the dry ingredients from the side of the bowl during the kneading process. Do not use the spatula near or directly behind the dough hooks. Use only a rubber or plastic spatula and keep it well away from the moving parts.

Safety Tip: Do not attempt to feed the dough into the dough hooks with your hands, spatula or any other utensil while the mixer is plugged into a power outlet or in operation.

2. As the ingredients start to form a ball, scrape down the sides of the bowl if necessary with a plastic spatula and remove your dough.

Safety Tip: Do not use the mixer near the edge of a bench or table top where it may fall off.

3. Depending on what recipe you are making, generally you will need to manually finish the kneading of your dough. Place dough

onto a well floured work bench or surface and knead until dough is smooth and elastic. This should take approximately 10-15 minutes.

4. After kneading place dough into a large well greased mixing bowl. Place the bowl in a warm, draft-free area and cover with a light cloth until the dough doubles in size.

5. Plunge fist into the centre of the risen dough to punch out excess air. Fold outer edges into the centre and turn dough out onto a lightly floured board for shaping. Place dough into tins for baking, or cut and shape dough for making buns, rolls, etc.

6. Final rising of dough. Cover the dough with a light cloth and place in a warm, draft-free area until doubled in size again. Glaze and bake.

Step 3: The finishing touches

To add interest to breads.

- Sprinkle loaves or buns with sesame, poppy, or caraway seeds before baking.
- Top loaves with shredded cheese during the last few minutes of baking.
- Drizzle sweet tea rings or buns with an icing sugar when cooled.

Glazes

- May be brushed over the dough at any time before, during or after baking.

Before Baking

- For a shiny crust, brush with cream or evaporated milk.
- For a glossy crust, brush with beaten egg white.

After Baking

- For a matt finish, brush with melted butter or margarine.

Helpful Hints for a Successful Dough continued

Doughy Tips.

Q. My dough hasn't worked, what went wrong?

A. If you over knead or under knead your dough the end result will be tough or spoiled. We suggest to throw the dough out and start again.

Q. I followed the recipe, however I'm finding that my mixture is dry and crumbly. Do I need to add more water?

A. Your mixture may be dry and crumbly for several reasons. One common problem is that flour tends to absorb or want more moisture/liquid, especially on a warm or humid day. We suggest you add more water, a drop at a time, until you reach a smooth ball/dough.

Q. I added too much water and my dough is very sticky, what can I do?

A. If the dough is smooth without lumps, then remove the dough from the bowl and turn it out onto a well floured benchtop. Knead the dough until you get a smooth and well formed dough, that is soft to touch and bounces back when pressed with the tip of your finger.

Note: When kneading consecutive dough recipes allow 5-10 minutes break so the Mixmaster does not build up too much temperature.

Helpful Hints for Better Cake Making

- Always have ingredients at room temperature. Warm the bowl to be used in really cold weather.
- Add flavouring and essences to the shortening for a better flavour.
- Add the sugar to the softened shortening and beat until the colour lightens slightly; there's no need to beat until the sugar is dissolved.
- Add whole eggs one at a time and beat until egg is absorbed. Eggs should not be cold as they can curdle mixtures.
- In our recipes we will use self-raising flour wherever possible. If plain flour is called for, it must be used to keep the balance of ingredients correct.
- Divide the flour and the liquid into two portions and add alternately with the liquid on speed 1 - don't over beat.
- If you don't have a tin the same size as the recipe suggests, here are some tins that are of similar capacity:
Use 2 x 20cm sandwich tins or a 1 x 28 x 18cm lamington tin or a 1 x 20 x 7cm deep round cake tin or 1 x standard loaf tin or a 1 x 20cm ring tin.
- Care must be taken when using a cake tin instead of a sandwich tin to lower the suggested temperature by approximately 25°C and lengthen the cooking time.
- Care should also be taken when substituting a cake tin for a ring tin, baba tin or any tin with a funnel as some cake mixtures that have a very high fat content may need the heat supplied by way of the funnel.
- Cooking times and temperature are meant only as a guide. Light mixtures should spring back when lightly touched and heavy mixtures, fruit cake and the like, should be tested with a skewer toward the end of the suggested cooking time.

Reasons for Poor Results

Sponge Cakes Shrink

Unbalanced ingredients, overbeating of egg whites, sudden changes of temperature or draught when taking from the oven.

Cakes Do Not Rise

Mostly due to gross overbeating, but can also be caused by too hot an oven during the first part of cooking.

Cakes Sink in the Centre

Too much fat, raising agent, liquid or sugar; too little flour; under cooking or slow cooking.

Cakes Run Over at Edges

Too much batter for size of pan, too cool an oven, too much sugar, over beating, too much raising agent.

Hard Outer Crust

Too much flour, too little sugar, over mixing, too hot an oven.

Moist, Sticky Outside

Too much sugar, over beating, under baking.

Coarse Crumbly Texture

Overbeating, low baking temperature.

Heavy, Close Texture

Too much fat or sugar, over mixing, under baking, or too hot an oven.

Fruit Sinks

Mixture too soft, damp fruit, too little flour, ingredients not correctly balanced, over beating.

Helpful Hints for Better Cake Making continued

Some Hints on Sponge Making

- There are basically two methods of sponge making. The whole egg method is the simpler, but better volume can be achieved if the egg whites are separated from the yolks.
- If you elect to separate the eggs, whip the whites until they hold peaks and gradually add the sugar a little at a time, beating well between each addition. Start with teaspoons of sugar and, as the mixture stiffens, add it more quickly. This process should take about 3-5 minutes. Only fold in the egg yolks until they disappear, say 1/2 minute.

These General Tips apply to either method:

- Eggs should be at room temperature.
- Castor sugar will give a better result as it dissolves more quickly.
- Bowl and beaters should be clean, dry and free from any fat.
- The fold speed of the Mixmaster will supply the gentle but thorough action necessary to fold in flour. Care should be taken to mix only until the flour has been folded thoroughly through the egg mixture. Always commence mixing on speed 1.
- The liquid should always be hot when folded through the sponge mixture. This starts the sponge cooking on the table, so it is essential to have the oven in readiness.
- Don't rush the folding in and be sure the liquid is evenly folded through the mixture. Any unmixed liquid will cause the sponge to be held down where the liquid lies.

Swiss Rolls

- The sponge mixture must be evenly distributed. A better result will be achieved if the mixture is poured along the tin and the tin tilted to allow the mixture to run to the corners, rather than spreading the mixture.
- While the roll is baking, sprinkle a little crystal sugar onto the sheet of greaseproof paper larger than the Swiss roll tin. Soften the jam to make it easy to spread. Immediately the roll comes from the oven, turn in onto the prepared paper and quickly spread the jam right out to the corners. Make the first roll a tight tuck and use the greaseproof paper to help you handle the hot sponge.
- It is essential the sponge is rolled quickly and that sponge is not over-cooked or the roll will crack.

Recipes – Baking

Tips

- Goats milk and skim milks can be used in these recipes.
- Margarine's and low fat butter's can also be used in these recipes.

Basic White Loaf

- 1 sachet dry yeast
- 1 tablespoon sugar
- 1 cup lukewarm water
- $\frac{3}{4}$ cup lukewarm milk
- 60g butter, melted
- 4 cups plain flour
- 1 teaspoon salt

1. Combine the first five ingredients in a small bowl and allow to stand in a warm place until mixture begins to froth. About 10 minutes.
2. Insert dough hooks into the mixer head (refer to page 5). Place sifted dry ingredients into the large Mixmaster bowl.
3. On Low speed (1-2), gradually add yeast mixture. Note that it will be necessary to scrape sides of bowl with a rubber spatula. Knead on Medium speed (4) for 3-4 minutes.
4. Continue the kneading process at Medium speed (4) until all ingredients are incorporated and dough forms a smooth ball. Mixture will be wet and sticky. Remove dough from bowl using a rubber spatula.
5. Place dough in a greased bowl, turning once to grease top of dough. Cover, and let rise in a warm place until doubled in size (40-50 minutes).
6. Punch down, fold sides to centre and turn the dough over. Remove the dough from the bowl and place onto a well floured surface. Lightly knead dough with palm of your hands until smooth and elastic. Cut dough in half and shape into two loaf pans. Cover

loosely with plastic wrap and allow to rise in a warm place until doubled in size. About 30-40 minutes. Preheat oven to 200°C.

7. Bake for approximately 30 minutes. Baked loaves sound hollow when tapped.

Variations to this recipe:

Breadsticks

1. Follow steps 1 - 5 from 'Basic White Loaf' recipe.
2. Punch down, fold sides to centre and turn the dough over. Knead on a lightly floured surface. Cut the dough into 8 portions and in each portion cut 1cm length slices.
3. Cut each slice into 1cm strips and roll into thin long stick like shapes.
4. Place onto a baking tray lined with baking paper, brush with milk and sprinkle with sea salt, and or poppy seeds and sesame seeds or cajun seasoning.
5. Bake on 200°C for 15 minutes, or until dry and crisp and golden brown.

Bread rolls

1. Follow steps 1 - 5 from 'Basic White Loaf' recipe.
2. Punch down, fold sides to centre and turn the dough over. Knead lightly on a well floured surface. Cut the dough into 12 portions and roll each portion across the bench, until an even soft ball.
3. Place each portion of dough onto a baking tray lined with baking paper. Cover in plastic wrap, allow to double in size (about 20-40 minutes) brush with eggwash and sprinkle with a mixture of poppy and sesame seeds.

- Note:** Eggwash is a mixture of egg yolk and tepid water used to glaze the top of uncooked bakery goods to give a shinny glaze.
4. Bake on 200°C for 15-20 minutes.

Baking continued

Sesame Rolls

1. Follow steps 1 - 5 from 'Basic White Loaf' recipe.
2. Preheat oven to 220°C and grease an oven slide.
3. Punch down, fold sides to centre and turn the dough over. Knead on a lightly floured surface. Divide the dough into 24 equal portions and shape into round, smooth balls.
4. Place close together onto the prepared tray and brush with melted butter and sprinkle with sesame seeds.
5. Cover with plastic wrap and allow to rise in a warm place for approximately 10 minutes.
6. Bake for approximately 20 minutes. Baked rolls sound hollow when tapped with the knuckles.

Variations to this recipe:

Flat rolls can be made using this recipe. After dividing the dough into equal portions and shaping into rounds, flatten each round with a rolling pin to approximately 1.5cm thick. Place close together on prepared trays, brush with melted butter and sprinkle with sesame seeds. Cover with plastic wrap and allow to rise in a warm place for approximately 10 minutes. Bake for approximately 20 minutes.

Sultana Loaf

Makes 2 loaves

- 1 sachet dry yeast
- 2 tablespoons sugar
- 60g butter or margarine, melted
- 1¼ cup lukewarm milk
- ¾ cup water
- 4 cups plain flour or bread flour
- 2 tablespoons sugar, extra
- 2 tablespoons powdered milk
- 1 teaspoon salt
- 1 cup sultanas

1. Combine the first five ingredients in a small bowl and allow to stand in a warm place until mixture begins to froth. About 10 minutes.
2. Insert dough hooks into the mixer head (refer to page 5). Place sifted dry ingredients, including sultanas into the larger Mixmaster bowl.
3. On Low speed (1-2), gradually add yeast mixture. Note it will be necessary to scrape sides of bowl with a rubber spatula. Knead on Medium speed (4) for approximately 4-5 minutes.
4. Continue the kneading process at Medium speed (4) until all ingredients are incorporated and dough forms a ball. Note mixture should be wet and sticky. Remove dough from bowl using a rubber spatula.
5. Place dough in a greased bowl, turning once to grease top. Cover with plastic wrap, and let rise in a warm place until doubled in size (40-50 minutes).
6. Punch down, fold sides to centre and turn the dough over. Turn dough out onto a well floured surface and knead lightly for 1-2 minutes until smooth. Cut and shape into loaf pans. Cover with plastic wrap and allow to rise in a warm place until doubled in size, approximately 20 minutes. Preheat oven to 200°C.
7. Bake for approximately 30 minutes. Baked loaves sound hollow when tapped with the knuckles. This makes 2 loaves.

Tip: If dough is too wet, while mixer is kneading slowly sprinkle about a tablespoon at a time of flour until mixture is smooth and moist but not wet. Dough should be slightly sticky, soft and elastic.

Variations to this recipe:

The sweet yeast dough can be used to make various sweet bakery goods such as the plaited sweet loaf, Chelsea bun or hot cross buns.

Baking continued

Plaited sweet loaf

1. Follow steps 1 - 5, from 'Sultana Loaf' recipe.
2. Punch down, fold sides to centre and turn the dough over. Knead on a lightly floured surface with well floured hands, until smooth, soft and elastic. Cut dough in half and roll out one half on a floured surface and shape into a 60cm x 30cm rectangle, about 2cm thick.
3. Cut into 3 equal lengths, bring each together at the top, pinch together to secure and then plait the 3 lengths, crossing one over and under the other, bring lengths together by pressing at the end.
4. Place onto a baking tray lined with baking paper and bake at 200°C for 40-45 minutes. Once cooked brushed with glaze. Repeat with the other half.

Glaze:

- 3 tablespoons sugar
- $\frac{1}{4}$ cup water
- 1 teaspoon gelatine

5. Place water, sugar and gelatine into a small saucepan. Stir over medium heat until sugar has dissolved, approximately 2 minutes.
6. When cold decorate top with icing. Mix together $\frac{1}{2}$ cup icing sugar with 20ml water and your favourite food colouring.

Chelsa bun

1. Roll out the dough onto a floured surface into a 60cm X 30cm rectangle, about 2cm thick. Sprinkle with $\frac{1}{2}$ cup mixed dried fruit or 1 green apple, peeled and chopped.
2. Take the longest side and roll to form the shape of a swiss roll.
3. Cut 5cm slices from the roll.
4. Place decoratively into a greased and lined 20cm round cake tin. Overlap the slices to

form a decorative bun. Brush with egg white. Allow to rise, about 15-20 minutes.

5. Bake for 40-45 minutes in a hot oven at 200°C. Once baked brush with glaze.

Note: see 'Plaited Sweet Loaf' for recipe for glaze recipe.

6. When cold decorate top with icing. Mix together $\frac{1}{2}$ cup icing sugar with 20ml water and pink food colouring.

Variations to this recipe:

Use this recipe to make hot cross buns. Divide the kneaded dough into 18 equal portions and roll. Place close together on a lined baking tray and mark a cross on each roll with a knife. Then pipe a mixture of stiff flour and water together over the top. Cover and allow to double in size, about 30 minutes. Bake in a hot oven at 200°C for 20-30 minutes. Brush with glaze while still hot. Eat warm with butter.

Wholemeal Loaf

- 1 sachet dry yeast
- 2 tablespoons sugar
- 2 cups lukewarm water
- 30g butter, melted
- 2 cups plain flour
- 2 cups wholemeal flour
- 1 teaspoon salt

1. Combine the yeast, sugar, water and butter in a small bowl and allow to stand in a warm place until mixture begins to froth. About 10 minutes.
2. Insert the dough hooks into the mixer head (refer to page 5). Place sifted dry ingredients into the large Mixmaster bowl.
3. Using Low speed (1-2), gradually add yeast mixture. Note, it will be necessary to scrape the sides of the bowl with a rubber spatula. Knead on Medium speed (4) for 3-5 minutes.

Baking continued

4. Continue the kneading process at Medium speed (4) until all ingredients are combined and the dough forms a ball. The dough will be soft and sticky. Remove dough from bowl using a rubber spatula.
5. Place dough in a greased bowl, turning once to grease top of dough. Cover with plastic wrap, and let rise in a warm place until doubled in size (40-50 minutes).
6. Punch down, fold sides to centre and turn the dough over. Knead on a lightly floured surface. Cut dough in half. Shape into loaf pans. Cover with plastic wrap and allow to rise in a warm place until doubled in size (about 30 minutes). Preheat oven to 200°C.
7. Bake for approximately 30 minutes. Baked loaves sound hollow when tapped with the knuckles.

Variations to this recipe:

This dough can be used to make bread rolls, breadsticks, and as a basis for other wholemeal bakery goods. See variations for 'Basic White Loaf' recipes.

Note: Grain bread flour mix can be used as a substitute for plain and wholemeal flours.

Foundation Butter Cake

125g butter or margarine

4 drops vanilla extract

³/₄ cup castor sugar

2 eggs

2 cups Self Raising flour

1 cup milk

1. Preheat oven to 180°C and grease a 20cm round cake tin or similar.
2. Using the small Mixmaster bowl, break up shortening (margarine) on Medium speed (5-6), add vanilla, sugar and cream on High speed (7-8) until light and creamy. Approximately 2 minutes.

3. Add eggs one at a time beating well between each addition.
4. Reduce to Low speed (2-3) and fold in sifted flour and milk alternately. Be careful not to use high speeds as flour will go everywhere! Mix for 3-4 minutes until cake batter is rich, smooth, thick and creamy.
5. Scrape batter into prepared tin. Bake for 30-35 minutes until golden brown.

Note: Creaming Butter and Sugar

When creaming butter or cream cheese use Low speeds (1-3) initially and make sure butter/cream cheese is chopped into cubes and added in small amounts until smooth and creamy. Once the desired quantity of butter/cream cheese has been added, slowly increase to High speed (7-9).

Variations to this recipe:

Upsidedown Peach cake

1. Preheat oven to 180°C. Grease and line a 20cm round cake tin.
2. Select 4 peaches. Cut each peach in half and remove their stones. Place cut side down in prepared cake tin. Sprinkle over 3 tablespoons white sugar and 20g chopped butter.
3. Follow steps 2 - 4 from the 'Foundation Butter Cake' recipe.
4. Spoon into cake tin. Level and bake for 40-45 minutes of until cake bounces back when touched in the centre. Allow cake to cool before removing from cake tin.
5. Serve peach side up. Makes 1 cake.

Variation:

Fresh pineapple slices, mango halves, peaches, pears or apricots can be used. Well drained tinned fruits such as plums can be used as well. Frozen mixed berries also work well.

Serving suggestion: Serve cake cut into wedges and spoon a dollop of thick cream over the top.

Baking continued

Lemon or Orange Cake

Add the rind of one lemon or orange into the cake batter, and or with the addition of butter and sugar and fold 2 tablespoons of poppy seeds into the cake batter makes an interesting and tasty cake.

Coffee Crumble

Mix in 2 tablespoons of instant coffee powder into the cake batter. On top of the cake batter sprinkle with a mixture of 1 tablespoon butter, 2 tablespoons plain flour, 2 tablespoons sugar, $\frac{1}{2}$ teaspoon of cinnamon and 2 tablespoons of instant coffee.

Chocolate Cake

60g unsweetened chocolate - melted and combine with milk from the recipe above and mix well into the cake batter before baking.

Marble Cake

Divide batter into 3, leave one plain, add pink food colour to second portion and 2 tablespoons of cocoa, $\frac{1}{8}$ teaspoon bicarbonate of soda and 1 tablespoon milk to the remaining cake batter. Drop spoonfuls of alternate colours into a 20cm ring tin, or place each coloured cake mixture into 3 separate tins and bake. Then cut into 2cm thick fingers and sandwich together with the fluffy frosting (recipe in icing section, page 19). As sandwiching fingers together create a 3x3 finger cake, decorate with extra frosting.

Berry Cake

Add 2 cups of fresh, frozen or canned mixed berries to the top of the cake batter in tins before baking. Make sure that berries are well drained if canned.

Vanilla Bean Sponge

3 eggs, room temperature & separated
 $\frac{1}{4}$ cup caster sugar

1 vanilla bean, split and seeds removed
1 cup self raising flour, sifted

1. Grease and flour a 20cm cake tin. Preheat oven to 180°C.
2. In the small mixing bowl, place the egg whites. Beat until soft peaks form, using High speed (7-8).
3. Reduce to Low speed (2-3) and add castor sugar slowly and whisk until mixture is thick and glossy. Increase to High speed (8-9) and beat in the egg yolks and vanilla, continue mixing until the mixture is well combined.
4. Stop the mixer. Remove beaters and bowl from the Mixmaster. Place bowl on bench and using a large metal spoon or a plastic spatula fold in the flour and 3 tablespoons water. Make sure the mixture is well combined and take care not to over beat as you will lose the air bubbles and the mixture will be flat and tough.
5. Spoon the mixture evenly into the greased tin and bake for 20-25 minutes or until a skewer is inserted in the centre and it comes out clean.
6. Once cooked run a knife around the sides of the cake to loosen the sponge from the pan and gently tap the bottom of the pan, turn out onto a cooling rack. Allow to cool before using.

Note: If you do not have vanilla beans use a vanilla extract or essence remembering that the extract is concentrate so only use a drop.

Serving suggestion:

When cake is cool, cut and spread the base with your favourite jam and top with firmly whipped cream. Place one sandwich on top of the other to make 1 cake. Sift with icing sugar for a plain effort or use more whipped cream and top with fresh berries.

Icings, Fillings, Frostings and Creams

Fluffy Butter Frosting

$\frac{1}{3}$ cup butter or margarine
4 cups pure icing sugar
pinch salt
3-4 tablespoons milk
 $1\frac{1}{2}$ teaspoon vanilla

1. Place all ingredients into the small Mixmaster bowl and on Low speed (1-2), mix until all ingredients are well combined, creamy, light and fluffy in texture.

Glaze Icing

3 tablespoons sugar
 $\frac{1}{4}$ cup water
1 teaspoon gelatine

1. Place all ingredients into a small saucepan. Stir over medium heat until sugar has dissolved, approximately 2 minutes.
2. Brush warm on top of baked sweet goods.

Royal Icing for Fruit Cakes

1 egg white
 $1\frac{1}{4}$ - $1\frac{1}{2}$ cups sifted pure icing sugar
1 teaspoon liquid glucose
2 teaspoons lemon juice
Extra icing sugar for kneading, approximately 1x500g box

1. Using the small Mixmaster bowl, beat the egg white on High speed (7-8).
2. Reduce to Low speed (1-2) and gradually add icing sugar .
3. Add glucose evenly through.
4. Beat on Medium speed (4-6) until smooth. Add lemon juice.
5. Turn out icing onto a well dusted surface of icing sugar, knead with icing sugar until icing is firm, smooth, stiff and very white.

Note: If icing is not being used immediately, cover with a damp cloth or plastic wrap.

Brunch, Lunchtime and Afternoon Tea

Yorkshire Pudding

4 egg yolks
3 egg whites
1 cup self raising flour
Pinch of salt
1 cup milk
60g butter or margarine, melted

1. Using the small Mixmaster bowl, beat egg whites until stiff but not dry on High speed (7-8) and set aside.
2. Using the large Mixmaster bowl, mix flour, salt, egg yolks, milk and melted butter on Low speed (2-3) until smooth.
3. Reduce to Lowest speed (1) and fold through beaten egg whites.
4. Pour into baking dish with a small quantity of heated oil, or use a 4 cup/20cm baba tin. Bake in a hot oven for 20-30 minutes.

Crepes

1½ cups plain flour
Pinch of salt
2 eggs
1¼ cups milk
1 tablespoon oil

1. Sift flour and salt into the small Mixmaster bowl.
2. Add combined eggs and milk gradually on Low speed (2-3). Increase speed to Medium (4-6) and beat well to remove any lumps.
3. Mix in oil. Allow to stand for 1 hour.
4. Grease heated Sunbeam Skillet. Pour about a ⅓ of a cup of the batter into the pan to make each crepe.
5. Cook quickly until lightly brown. Toss and brown other side. Sprinkle with lemon juice and sugar. Roll and serve hot.

Filling suggestions:

Smoked Salmon Crepe with a slice of Camembert cheese, red onions and snow pea sprouts. Roll up and serve with a fresh garden salad.

Cinnamon and Apple Tea Ring

DOUGH:

1 sachet dry yeast
2 tablespoons sugar
60g butter, melted
1¼ cup lukewarm milk
¾ cup water
4 cups plain flour
2 tablespoons sugar, extra
2 tablespoons powdered milk
1 teaspoon salt
1 cup sultanas

APPLE FILLING:

⅓ cup water
¼ cup sugar
3 apples, peeled, cored and cubed
½ teaspoon cinnamon
5 drops vanilla extract
½ tablespoon cornflour,
dissolved in ½ tablespoon water

GLAZE:

3 tablespoons sugar
¼ cup water
1 teaspoon gelatine

1. Place water and sugar from the apple filling ingredients into a saucepan and dissolve sugar over medium heat. Increase heat and bring to the boil. Add apples and cook until slightly crisp in the centre.

Brunch, Lunchtime and Afternoon Tea continued

- DO NOT ALLOW APPLE PIECES TO LOOSE SHAPE. Add cinnamon and vanilla. Stir in dissolved cornflour, and cook for a further minute until mixture thickens. Remove from heat and allow to cool.
- Combine the first five ingredients in a small bowl and allow to stand in a warm place until mixture begins to froth. About 10 minutes.
 - Insert dough hooks into the mixer head (refer to page 5). Place sifted dry ingredients, including sultanas into the large Mixmaster bowl.
 - On Low speed (1-2), gradually add yeast mixture. Note, it will be necessary to scrape sides of bowl with a rubber spatula. Knead on Medium speed (4) for 4-5 minutes.
 - Continue the kneading process at Medium speed (4) until all ingredients are incorporated and dough forms a ball. Dough will be smooth and sticky. Remove dough from bowl using a rubber spatula.
 - Place dough in a greased bowl, turning once to grease top. Cover with plastic wrap and let rise in a warm place until doubled in size (40-50 minutes).
 - Punch down, fold sides to centre and turn the dough over. Knead dough on a lightly floured surface until soft and smooth. Cut in half and roll dough out into a rectangle, approximately 30x20cm.
 - Spoon apple mixture along the long side of the dough and roll up tightly, Swiss Roll fashion, from the wide end.
 - Ease the roll into a greased ring tin and join ends. Cover, and allow to rise for approximately 40-50 minutes. Preheat oven to 200°C.
 - Bake for approximately 30-35 minutes or until golden brown. Remove from the tin and glaze while still warm.

- To glaze place water, sugar and gelatine into a small saucepan. Stir over medium heat until sugar has dissolved, approximately 2 minutes.

Note: Repeat with the other dough half.

Variation to this recipe:

Apple Fruit Loaf

Mix 1 cup of mixed fruit into the dough instead of sultanas. Bring the longer sides together to meet at the middle. Score with a knife across the top. Brush with egg yolk and milk. Top with $\frac{1}{2}$ cup of chopped walnuts. When cool top with icing if desired.

Shortbread

125g butter or margarine

$\frac{1}{4}$ cup castor sugar

1 $\frac{1}{2}$ cups plain flour

$\frac{1}{2}$ teaspoon baking powder

- Preheat oven to 190°C and grease a 23cm square sandwich tin.
- Using the small Mixmaster bowl, cream the butter or margarine and sugar on Medium speed (6) until light and fluffy.
- Stop Mixmaster and scrape down sides of bowl with spatula. On Low speed (1-2) slowly add flour and baking powder. Allow to mix until mixture is crumbly.
- Press into prepared cake tin, fork and pinch sides and bake for 15-20 minutes.

Brunch, Lunchtime and Afternoon Tea (continued)

Carrot, Prune and Sultana Cake

6-8 large prunes, pitted
1 cup walnuts
1 cup sultanas
4 medium carrots, peeled, shredded
4 eggs
1½ cups castor sugar
¾ cup vegetable oil
2½ cups plain flour
2 teaspoons bicarbonate of soda
2 teaspoons baking powder
½ teaspoon salt
2 teaspoons cinnamon
½ teaspoon mixed spice
¼ teaspoon nutmeg
juice and grate rind of a lemon or orange

CREAM CHEESE FROSTING:

125g pkt cream cheese, softened
30g butter
3 teaspoons lemon juice
2½ cups icing sugar

1. Preheat oven to 160°C. Grease and line 2 loaf tins and set aside.
2. Using a Sunbeam food processor or a knife, chop prunes and walnuts. Empty into the large Mixmaster bowl together with the sultanas.

3. Add shredded carrots into the large Mixmaster bowl and set aside.
4. In the small Mixmaster bowl beat eggs and sugar on Medium speed (5), for 2 minutes.
5. Add oil and beat for 3 minutes on Medium speed (5) until mixture is thick and creamy.
6. Using Low speed (1-2), fold in dry ingredients and set aside.
7. Position the large Mixmaster bowl onto the mixer and on Low speed (1-2) fold in the egg mixture.
8. Place mixture into prepared tins and bake for 50 minutes. Cool in tins, then remove to wire rack and cool completely.
9. **Frosting:** Beat cream cheese, butter, lemon and sugar juice together on Medium speed (4) until light and creamy.
10. Add icing sugar slowly and continue beating on Medium speed (5-6) until combined.
11. Spread frosting over cold cakes and decorate as desired.

Pre-Dinner Nibbles

Fritter Batter

Covers 8-12 fritters

- 1 cup plain flour
- 3 teaspoons baking powder
- Pinch of salt
- 1 egg
- ½ cup milk

1. Sift flour, baking powder and salt into the small Mixmaster bowl, add egg and milk and beat on Low speed (2), until combined and mixture is smooth, approximately 1-2 minutes.
2. Dip your favourite prepared fruit or vegetable into batter and deep fry immediately.

Ingredient suggestions:

Raw or cooked fruits, cheese fritters, fried oysters.

Note: When deep frying fritters ensure that your oil is bubbling and very hot. Never cook fritters in oil that doesn't sizzle when food is placed into the deep fryer.

Mayonnaise

- 3 eggs
- 2 tablespoons mustard
- 1 teaspoon salt
- 2 tablespoons sugar
- ½ cup vinegar
- 2 cups vegetable or olive oil

1. Combine eggs, mustard, salt, sugar and beat, starting on Low speed (1-2) and increasing slowly to High speed (9). Gradually add the vinegar and oil to the mixture over a period of 3-5 minutes until mixture becomes very thick and creamy in consistency.
2. Taste and adjust flavour of mayonnaise with salt and pepper.

Savoury Puffs

Makes approximately 40

- Choux Pastry Puffs
- 60g butter or margarine
- 1 cup water
- 1 cup plain flour, sifted
- 3 large eggs

1. Preheat oven to 220°C. Grease and line oven slides.
2. Place butter or margarine and water in a saucepan and bring to the boil
3. Stir in flour. Cook stirring until dough leaves the side of the saucepan.
4. Cool slightly. Place mixture in the small Mixmaster bowl and beat for 1 minute on Medium speed (5).
5. Add eggs one at a time and mix on Medium speed (5) until mixture is stiff and shiny.
6. Drop tablespoon size portions onto prepared slides.
7. Bake for 15 minutes, then reduce heat to 160°C and bake until dry inside. Cool, fill with sweet or savoury fillings and serve.

Note: These Choux Pastry Puffs freeze well.

Pre-Dinner Nibbles (continued)

Fillings for the Choux Pastry Puffs:

Basic White Sauce

2 tablespoons butter or margarine

2 tablespoons flour

$\frac{1}{2}$ teaspoon salt

$\frac{1}{4}$ teaspoon cayenne pepper

$\frac{1}{2}$ cup milk

1. Melt butter or margarine in a saucepan, but do not boil.
2. Remove from heat, add flour, salt and pepper, stir until smooth. Do not brown.
3. Add milk all at once. Stir until sauce boils and thickens.
4. Use one of the suggested fillings or divide into two or three.

Salmon Filling

1 x 125g tin salmon

2 teaspoons mayonnaise

lemon juice to taste

1. Drain salmon, and flake salmon into a bowl. Add mayonnaise, white sauce and mix well. Season with salt and pepper. Add lemon juice to taste. Pipe mixture into cooled puff's and serve warm or cold.

Asparagus Filling

1 small tin asparagus cuts, drained well and finely chopped

90g grated parmesan or romano cheese

1. Mix asparagus, white sauce and cheese until well combined. Season to taste with salt and pepper and pipe into pastry puffs. Serve hot or cold.

Mushroom and Bacon Filling

1 x 250g tin mushrooms, well drained and finely chopped

2 rashers cooked bacon, ham or prosciutto finely chopped

1. Mix together the white sauce, mushrooms and bacon in a small bowl until well combined. Pipe into pastry puffs and serve hot or cold.

Note: The white sauce is nice too, with freshly chopped mixed herbs and brie.

After Dinner

Sweet Crepes

- 1½ cups plain flour
- Pinch of salt
- 2 eggs
- 1¼ cups milk
- 1 tablespoon oil

1. Sift flour and salt into the small Mixmaster bowl.
2. Add combined eggs and milk gradually on Low speed (1). Increase speed to Medium (5) and beat well to remove any lumps.
3. Mix in oil and allow to stand for 1 hour.
4. Grease heated Sunbeam Skillet or Frypan. Pour about a ⅓ of a cup of batter into the pan to make each crepe.
5. Cook quickly until lightly brown. Toss and brown other side. Sprinkle with lemon juice and sugar. Roll and serve hot.

Serving suggestion:

- After crepe is cooked spread with nutella and roll up. Serve warm or serve cold (this one is great with the kiddies and big kids alike!).

Waffles

Makes approximately 8

- 2 eggs separated
- ¼ cup sugar
- ¾ cup milk
- ½ cup water
- 2 cups self raising flour
- Pinch of salt
- 125g butter or margarine, melted

1. Using the small Mixmaster bowl whisk egg whites stiffly on High speed (7-8). Continue mixing at High speed (7-8), add half of the sugar and beat until dissolved, set aside.

2. Using the large Mixmaster bowl whisk egg yolks and remaining sugar on Very High speed (12). Reduce to Low speed (1) and add milk and water, then sift in dry ingredients.
3. Mix in melted butter or margarine.
4. On Low speed (1-2), fold in stiffly beaten egg whites.
5. Bake in a greased, preheated waffle iron. Use approximately ½ a cup of mixture for each waffle. Each waffle should take approximately 2 minutes to cook.

Variations to this recipe:

Add any one of the following:

- 2 sliced bananas, 2 teaspoons cinnamon,
- 2 tablespoons cocoa and omit 2 tablespoons flour. Use wholemeal self raising flour instead of white flour.

Hazelnut & Cashew Torte

- 6 egg whites
- 4 egg yolks
- ¾ cup nutella
- 100g dark chocolate, melted
- ½ cup plain flour
- 100g hazelnut meal
- ½ cup crushed cashews

Topping:

- 250g dark chocolate melted
- 250g cream heated
- 100g whole hazelnuts, toasted, skins removed
- 100g whole cashews, toasted

1. Preheat oven 160°C. Grease and line 20cm round cake tin.
2. In the large Mixmaster bowl whisk egg whites until stiff peaks form, on High speed (7-8). Remove from bowl and set aside.

After Dinner (continued)

- Using the large Mixmaster bowl once again, beat egg yolks, nutella and 100g melted chocolate together on Medium speed (5). Add flour, hazelnut meal, crushed cashews and fold in the egg whites using Low speed (1-3).
- Pour into the prepared cake tin and bake 40-45 minutes.
- Allow to cool in pan for 10 minutes before removing cake from pan and cool on a wire rack.
- Combine the melted chocolate and heated cream together. Stir until smooth and allow to cool. As mixture cools it will become thick and glossy.
- Spoon topping over the cake. Top with cashews and hazelnuts. Serve in thin wedges.

Pavlova

- 4 egg whites
 - 1 cup castor sugar
 - 2 teaspoons vinegar
 - 3 teaspoons cornflour
 - ½ teaspoon vanilla extract
- Preheat oven to 120°C. Grease and flour 20cm round tray.
 - Using the small Mixmaster bowl ensuring that it is dry and clean, whip the egg whites until stiff on High speed (7-8).
 - On High speed (7-8) gradually add the sugar, a teaspoon at a time to start. Beat well between each addition. As mixture thickens add the sugar more quickly. This should take approximately 5-8 minutes mixing time.
 - Reduce to Low speed (1-2) and fold through vinegar, cornflour and vanilla. Continue mixing until mixture is stiff and glossy, approximately 2-3 minutes.

- Spread half of the pavlova mixture onto a prepared tray. Pipe the remaining mixture to form a border.
- Bake for 1¼-1½ hours. If able, turn oven off and allow to cool in oven overnight or for a few hours.

Serving suggestion:

Decorate as desired. Fresh cream and lots of fresh berries is my favourite. Sprinkled with icing sugar to finish off.

Strawberry Mousses

- 2 punnets of strawberries, washed and hulled
- ¾ cup castor sugar
- 2 tablespoons lemon juice
- 3 teaspoons gelatin
- 2 tablespoons cold water
- 300ml thickened cream
- Extra strawberries for decoration

- Place strawberries and half the sugar into a saucepan and slowly bring to the boil.
- Add remaining sugar and lemon juice, stir over low heat until sugar is dissolved.
- Soften gelatin in water, dissolve in hot strawberry mixture. Cool slightly.
- Place into a Sunbeam food processor and process until smooth. Allow to cool.
- Using the small Mixmaster bowl, whisk chilled cream on Very High speed (10-12) until thick.
- On Low speed (1), fold through the cooled strawberry mixture and mix on Medium speed (4-6) until just combined.
- Pour into individual serving dishes or a 4 cup mould. Decorate with strawberries.

Kids Treats

Fluffy Pikelets Makes approximately 12

- 1½ cups S.R. flour
- Pinch of salt
- 1 teaspoon bicarbonate of soda
- 2 tablespoons sugar
- 1 egg
- 1¼ cups milk
- 4-5 drops vanilla extract
- 40g butter or margarine

1. Sift flour, salt and soda into the small Mixmaster bowl. Add sugar, egg, milk and vanilla. Beat on Low speed (1-2) until mixed.
2. Increase to Medium speed (5) and beat for 1-2 minutes until smooth.
3. Fold in melted butter on Low speed (1). Place spoonfuls onto a hot Sunbeam Frypan and cook until bubbled and have turned brown.

Note: Suitable to freeze and reheat.

Serving suggestions:

- Serve pikelets hot or cold.
- Serve with whipped cream and jam for a sweet treat.
- For a savoury treat, top with vegemite & butter or ham & cheese.
- Add freshly chopped herbs to the batter and serve cooked pikelets with cream cheese, smoked salmon and caviar.

Cornflake Cookies

- ½ cup butter or margarine
- ½ cup castor sugar
- 1 egg
- vanilla essence
- ½ cup currants
- ½ cup coconut
- 1¼ cups S.R. flour
- Pinch of salt
- 2 cups cornflakes, crushed

1. Preheat oven to 180°C. Grease, line oven slides.
2. Using the small Mixmaster bowl, cream together butter and sugar on Medium speed (6).
3. Add egg and beat well.
4. Reduce to Low speed (1) and add vanilla, currants and coconut.
5. On Low speed (1) fold in flour and salt in two portions, until mixture is well combined.
6. Spread cornflakes onto a piece of paper and drop teaspoonfuls of mixture onto cornflakes. Roll to coat.
7. Place onto prepared slides and bake for 15 minutes. Allow to cool on slides.

Chocolate Chip Cookies Makes approx 100

- 125g butter or margarine
- ¾ cup white sugar
- ⅔ cup brown sugar
- 2 eggs
- 1 teaspoon vanilla essence
- 2¼ cups plain flour
- 1 teaspoon salt
- 1 teaspoon bicarbonate of soda
- 1 cup peanuts (raw)
- 1 cup choc chips (dark)
- 1 cup M&M's (optional)

1. Preheat oven to 170°C and grease oven slides.
2. Using the large Mixmaster bowl, break up the shortening (butter or margarine) on Low speed (1-2).
3. Increase to Medium speed (4) and add sugars.
4. Add eggs, vanilla and cream until light and fluffy on High speed (7).
5. On Low speed (1) and fold in sifted dry ingredients and mix until well combined.

Kids Treats (continued)

- Using a spoon fold in the chocolate bits, M&M's and nuts until combined.
- Place teaspoonfuls of mixture on trays and bake for 12-15 minutes or until golden.
- Allow to cool on wire racks. When cooled, the cookies can be sandwiched together with nutella and sprinkled with icing sugar.

Quick Cup Cakes

Makes 12

60g butter or margarine
1¹/₄ cups S.R. flour
½ cup sugar
2 eggs
¼ cup milk
1 teaspoon vanilla essence

- Preheat oven to 220°C and place patty cases into patty tins and set aside.
- Using the small Mixmaster bowl, place all ingredients into the bowl and beat until combined, start mixing on Low speed (1), slowly increasing to Medium speed (5).
- Place rounded dessert spoonfuls of batter into the patty cases and bake for 12-15 minutes.
- Allow to cool and decorate as desired.

Variations to this recipe:

Top the cake batter in the patty cases with frozen berries before baking.

Serving suggestion:

When patty cakes are cooked drizzle with icing sugar and top with a small eatable decoration like marshmallows, or make Butterfly cakes.

Butterfly cakes

Cut the tops off the patty cakes and cut in-half. Top with a small spoonful of cream or thick custard. Place cake halves back into the centre of the cup cakes facing up to create wings. Dust with icing sugar.

Meringues

2 egg whites
90g caster sugar
90g icing sugar

- Preheat oven to 120°C. Grease two oven slides with baking paper.
- Using the small Mixmaster bowl, beat egg whites until stiff but not dry, on High speed (7-8).
- On High speed (7-8) add castor sugar gradually, beating well.
- Reduce to Low speed (1) and fold in icing sugar. Mix until stiff and shiny.
- Using a star shaped nozzle, pipe small meringues onto the prepared slide. If you do not have a piping bag use two teaspoons. Decorate if desired. Bake for 10 minutes, reduce heat to 100°C and continue cooking for 20-25 minutes.
- When cold, join in pairs with icing (optional).

Marshmallows

Makes 12

30g gelatine (3 x 10g sachets)
2 cups castor sugar
250ml boiling water
vanilla or strawberry essence
food colouring (optional)
Cornflour for coating

- Dissolve the gelatine in 125ml boiling water whisking together with a fork. Keep in bowl of hot water until ready to use so it does not gel.
- Using the large Mixmaster bowl and a metal spoon combine the sugar, 250ml boiling water and vanilla. Stir and add the dissolved gelatine.

Kids Treats (continued)

- Mix on Low speed (1) for 2 minutes slowly increasing to High speed (7). Leave on High speed for 10 minutes or until the mixture becomes thick and creamy. Add a few drops of your favourite food colouring (optional) and increase speed to Very High (12). Beat for a further 5-7 minutes, until mixture is very stiff and fluffy.
- Lightly grease 2 x 22cm square tins or similar with vegetable oil.
- Scrape down sides of bowl occasionally during beating.
- Spoon mixture onto oven slides, spread evenly. Leave to set at room temperature, approximately 30 minutes.
- When firm to touch, cut into cubes or fun shapes that the kids will enjoy. Toss in cornflour.

Note: Marshmallow mixture can also be piped onto oiled trays, if you have a piping bag and nozzle.

Serving suggestion:

Marshmallow's are great served in hot chocolates or coffee. They are a fun afternoon treat for the kids and can be used to make rocky road.

Rocky Road

For rocky road combine some mixed nuts, and dried fruit and marshmallows. Mix with melted chocolate and spread into a greased and lined baking sheet. Set in the fridge if it's a hot day. Cut into slices and serve.

Nougat

- 2 cups sugar
- 1 cup liquefied glucose
- ¼ cup honey
- Pinch of salt
- ¼ cup water
- 2 egg whites
- 1 teaspoon vanilla
- 40g butter, melted
- 100g blanched almonds, lightly toasted

- Grease and line a 28 x 18cm lamington tin.
- Place sugar, glucose, honey, salt and water in a saucepan. Stir over low heat until sugar is dissolved then bring to the boil. Cook for 20 minutes until mixture forms a hard ball when tested in a small amount of water. Be sure not to discolour.
- Using the small Mixmaster bowl, whisk the egg whites until stiff on Very High speed (12). Pour 1 cup of hot syrup slowly into the egg whites on High speed (7-8). Continue beating until mixture is thick and holds its shape. Place in large Mixmaster bowl.
- Continue boiling syrup until brittle threads form when tested in a small amount of cold water.
- Pour in a little of the remaining syrup into meringue while beating on High speed (7). Continue beating until very thick. Add the butter and nuts, continue beating while pouring in the last remaining syrup, let run until it is combined.
- Spoon into prepared tin and refrigerate until firm.
- Turn out in large block and with a sharp knife, cut into square.

EASTER

Hot Cross Buns

Makes 18

Dough

- 1 sachet dry yeast
- 2 tablespoons sugar
- 60g butter, melted
- 1¹/₄ cup lukewarm milk
- ³/₄ cup water
- 4 cups plain flour
- 2 tablespoons sugar, extra
- 2 tablespoons powdered milk
- 1 teaspoon salt
- 1 cup sultanas

Crosses

- ¹/₂ cup plain flour
- ¹/₄ cup water

Glaze

- 3 tablespoons sugar
- ¹/₄ cup water
- 1 teaspoon gelatin

1. Combine the first five ingredients in a

1. Do hookentsto ne tedxer headn arefer to page 5). Pp ce sifmelhet our1.1-2), gradually adddry yea a4

Special Occasions (continued)

CHRISTMAS

Christmas Cake

Makes 2 cakes

2 cups sultanas
2 cups currants
2 cups raisins (seedless)
100g dried figs or prunes
100g dates
½ cup mixed peel
½ cup almonds
¾ cup walnuts
1 cup glazed cherries
125ml sherry
250ml brandy
250ml whisky
250g butter or margarine
250g brown sugar
5 eggs
60g dark chocolate, melted
1 teaspoon parisian essence
1 teaspoon vanilla extract
1 tablespoon glycerin or vegetable oil
1 tablespoon golden syrup or honey
1 tablespoon raspberry or plum jam
Grated rind and juice of 1 orange or lemon
500g plain flour
1 tablespoon baking powder
2 teaspoons mixed spices
¼ teaspoon ground ginger
½ teaspoon salt

1. Wash and dry sultanas, currants and raisins.
2. Cut up figs, dates, mixed peel and nuts into small pieces; halve the cherries and raisins.
3. Mix all the fruit and nuts, add brandy, sherry and whisky. Allow to stand for several days, or at least overnight if longer time is not possible - use a screw top jar.
4. Preheat oven to 150°C. Line 2 x 20cm round or square tins with one thickness of brown greaseproof paper or 2 sheets of white greaseproof paper. Bring the lining about 3cm above top edge of the tin.
5. Using the large Mixmaster bowl, cream butter and sugar on Medium speed (6).
6. Add eggs one at a time and mix well after each addition. Add chocolate, Parisian essence, vanilla extract, glycerin, golden syrup, jam and orange or lemon rind and juice.
7. On Low speed (1-2), add sifted dry ingredients and fruit mix from step 3 alternately to mixture until all is added.
8. Place mixture in the prepared tins and bake for 3-3½ hours.
9. When cooked, remove from oven and trickle 2 tablespoons brandy, rum or sherry over the cake while hot. Wrap immediately in several thicknesses of paper, leaving cake in the tin, and allow to cool slowly. This improves the cake as the steam in the slow cooling keeps the cake moist.

Special Occasions (continued)

Christmas Shortbread

125g butter or margarine

1/2 cup castor sugar

1 1/2 cups plain flour

1/2 teaspoon baking powder

1/2 cup glazed ginger, freshly chopped

Melted chocolate

Freshly chopped nuts and red glazed cherries

1. Preheat oven to 190°C. Grease and line a 20cm round sandwich tin.
2. In the small Mixmaster bowl, cream the butter or margarine and sugar on Medium speed (4-6), until light and fluffy.
3. Add flour, baking powder and ginger and mix on Low speed (1) until the mixture is crumbly.
4. Press into prepared cake tin, fork and pinch sides and bake for 15-20 minutes.
5. Once cooled, drizzle the melted chocolate over the shortbread and top with freshly chopped nuts and red glazed cherries.



Consumer Hotline

Australia

1800 025 059

New Zealand

(09) 912 0747

Consumer information:
1800 025 059 or www.sunbeam.com.au

 is a registered Trademark of Sunbeam Corporation Limited. ACN 000 006 771.

© Sunbeam Corporation Limited 2002.