

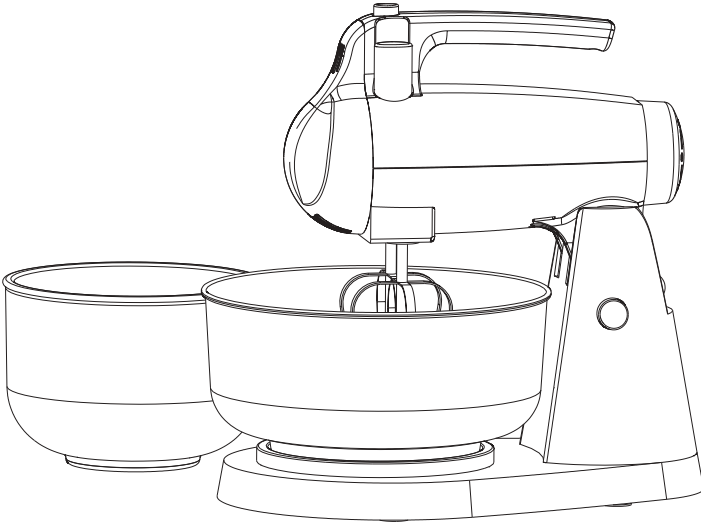

Stand Mixer



Item Stock Number

168949

UPC:

681131689496

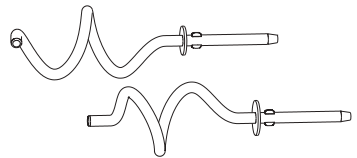

www.gehousewares.com

For Product Service, Call Customer Assistance at 1-877-207-0923

168949 • UPC 681131689496

IMPORTANT SAFEGUARDS

When using electrical appliances, basic safety precautions should always be followed, including the following:

1. Read all instructions.
2. To protect against risk of electrical shock, do not put cord, plug, or Mixer body in water or other liquid. This may cause personal injury or damage to the product.
3. Close supervision is necessary when Mixer is used by or near children.
4. Unplug from outlet when not in use, before putting on or taking off parts and before cleaning.
5. Avoid contacting moving parts. Keep hands, hair, clothing, as well as spatulas and other utensils, away from beaters during operation to reduce the risk of injury to persons, and/or damage to the Mixer.
6. Do not operate Mixer with a damaged cord or plug, or after the appliance malfunctions, or is dropped or damaged in any manner. Call our toll-free Customer Assistance Number for information on examination, repair or electrical or mechanical adjustment.
7. The use of attachments not recommended or sold by the appliance manufacturer for use with this model may cause fire, electrical shock or injury.
8. Do not use outdoors or for commercial purposes.
9. Do not let cord hang over edge of table or countertop, or touch hot surfaces, including stove.
10. Remove beaters from Mixer before washing.
11. Do not place Mixer or bowls on or near a hot gas or electric burner, or in a heated oven.
12. Check that control is off before plugging cord into wall outlet. To disconnect, turn control to OFF, then remove plug from wall outlet.
13. Do not use Mixer for other than intended use.
14. Do not leave Mixer unattended while it is operating.

SAVE THESE INSTRUCTIONS!

Consumer Safety Information

THIS UNIT IS FOR HOUSEHOLD USE ONLY.

When your **GE**® Mixer is first used, you may experience an odor and possibly a slight wisp of smoke from your mixer's motor. This is caused by the heat curing of the insulation, which protects the motor and is normal. After the first few uses, this will no longer occur.

This appliance is equipped with a polarized plug. This type of plug has one blade wider than the other. The plug will fit into an electrical outlet only one way. This is a safety feature intended to help reduce the risk of electrical shock. If you are unable to insert the plug into the outlet,

try reversing the plug. If the plug should still fail to fit, contact a qualified electrician to replace the obsolete outlet. Do not attempt to defeat the safety purpose of the polarized plug by modifying the plug in any way.

WARNING: To reduce risk of personal injury, always unplug Mixer before inserting or removing beaters or dough hooks.

BEFORE FIRST USE: Wash bowl, beaters, and dough hooks in hot, soapy water. Then rinse and dry.

Mixing Tips

Cookie dough is one of the thickest doughs to mix. Make it easier by following these tips:

- Use a large mixing bowl so that the ingredients spread out for easier mixing.
- Have butter or margarine at room temperature.
- Add ingredients one at a time and thoroughly mix after each addition.
- Add flour one cup at a time.
- To add chocolate chips or nuts to a very thick dough or batter, we recommend stirring them in by hand at the very end of the recipe.

Parts and Features

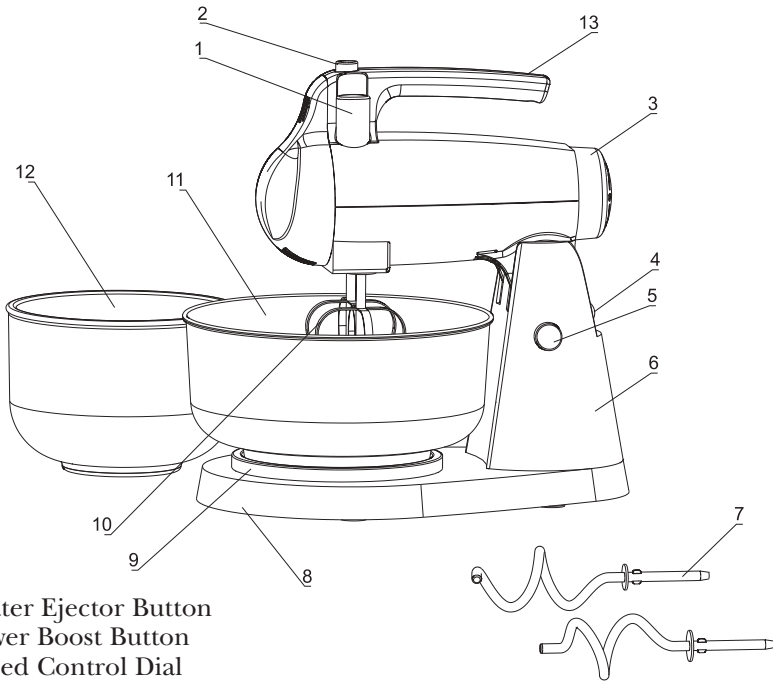

1. Beater Ejector Button
2. Power Boost Button
3. Speed Control Dial
4. Mixer-Release Trigger
5. Head lock Button
6. Stand
7. Dough Hooks
8. Base
9. Dual Position Turntable
10. Bowl-Fit Beaters
11. Large Stainless Steel Mixing Bowl
12. Small Glass Mixing Bowl
13. Handle

Using Your Mixer

How to Assemble the Stand Mixer

Before assembling the Mixer, make sure the speed control dial is in the OFF position and the electric cord is unplugged.

Attaching the Turntable

To assure the proper positioning of the mixing bowl with relation to the beaters, the turntable has two positions. Before adjusting the turntable, decide which bowl will be used. To adjust the turntable, remove it from the base. There are icons on the base depicting a large (stainless steel) bowl and a small (glass) bowl. Place the turntable in the hole with the icon corresponding to the bowl that will be used.

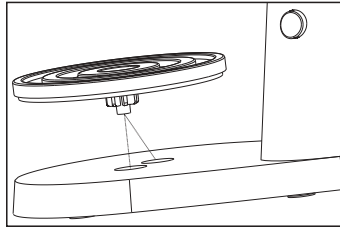

Attaching the Mixer Head

To attach the mixing head, press in on the Mixer release trigger, located at the rear of the stand.

Place the Mixer head on the stand so that the metal pivot on the bottom of the Mixer head goes into the latched opening on the top of the stand.

As you release pressure from the Mixer-release trigger, the top of the latch should clamp around the metal pivot. Once the mixing head is lowered into position, it will lock into place.

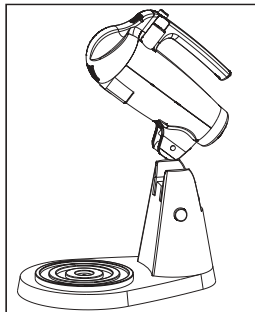

To tilt the mixing head, upward, press the head lock button inward while pulling up on the handle of the mixing head.

NOTE: This Mixer is NOT intended for use away from the stand.

Adding the Mixing Bowl

When using the large bowl, the turntable should be placed in the off-center position, where the large bowl icon is located. Similarly, when using the small bowl, the turntable should be placed in the center position where the small bowl icon is located.

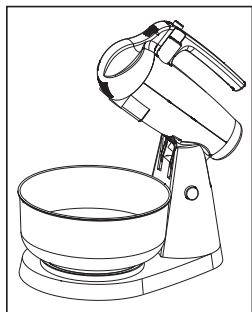

Mixing bowls should NEVER be used in a conventional oven, microwave oven, on top of the range or on any other heated surface. If mixing bowls are scratched or chipped, do not use. Mixer bowl should not be used to blend in hot liquids.

Inserting the Beaters

NOTE: It is important that the beaters go into the correct sockets. Otherwise the Mixer will not give you the proper mixing action. Do not risk ruining a recipe or damaging your Mixer. Read the following instructions carefully.

1. Make sure the Mixer is unplugged and speed control dial is set to 0 (OFF) position. Lift Mixer head up and back to pull it out of the way of the bowl.

The beater with the small washer (has a plastic button on the bottom) goes into the socket on the side of the mixer nearest the side of the bowl. The beater with the larger washer (square-shaped) goes into the socket nearest the center of the bowl.

Because each beater only fits in its proper socket, please follow the above instructions when you inserting beaters. *Please refer to the icons beside the sockets.*

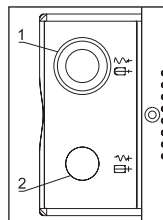
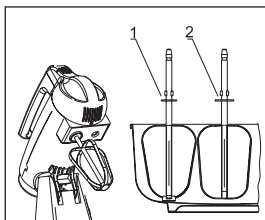
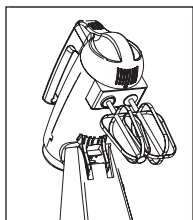

1. Small Washer Beater
2. Big Washer Beater

2. Insert the beaters one at a time by aligning the notches on the beater with the slots on the Mixer head. Use a combination of pressing and twisting motion until the beaters snap into position.

If a beater should not properly snap into place, pull it out of the socket and rotate it one quarter turn. Reinsert the beater into the socket until it snaps into position.

Inserting Dough Hooks

NOTE: The dough hooks must go into the correct sockets. The Mixer will operate with the dough hooks in the wrong position. However, you will not get proper kneading action and you could risk ruining a recipe. Read the following instructions carefully.

1. Make sure Mixer is unplugged and speed control dial is set to OFF. Lift Mixer head up and back to tilt it out of the way of the bowl, while holding it in an upright position.
2. The dough hook with the small washer and foot goes into the socket on the side of the Mixer nearest the side of the bowl. The other dough hook with the large washer goes into the socket nearest the center of the bowl. Insert the dough hooks one at a time by aligning the notches on the hooks with the slots on the Mixer head. Use a combination of pressing and twisting motions until the dough hooks snap into position. *Please refer to the icons beside the sockets.*

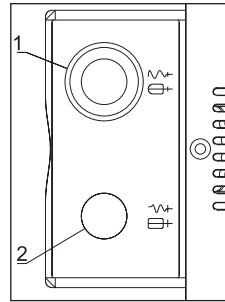
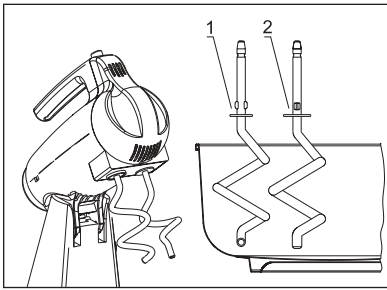

1. Small Washer Hook
2. Big Washer Hook

Operating Instructions

ABOUT THE SPEED CONTROL DIAL

The speed control dial is used for turning the Mixer ON and OFF and for selecting its 12 mixing speeds.

Rotate the speed control dial in a clockwise direction to increase mixing speed; and in a counterclockwise direction to decrease mixing speed.

As you rotate the speed control dial, notice that a numbered speed is aligned with the indicator on top of the Mixer head. This numbered speed indicates the speed at which the Mixer is operating.

Rotate the speed control dial until the indicator is opposite the numbered speed you wish to use.

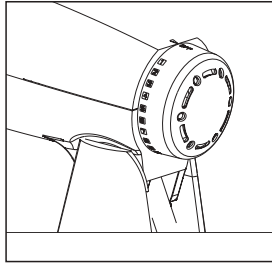

POWER BOOST FEATURE

NOTE: Do not use Power Boost for more than two minutes at a time or motor may overheat.

Press down on the Power Boost button located beside the top handle to automatically increase the beater speed by 200 RPM for an immediate boost of power.

HEAD LOCK FEATURE

The head lock feature locks the mixing head in the down position for added control while mixing and locks it in the up position for added convenience while cleaning.

To unlock, press in on the head lock button located on the side of the stand.

To lock, lower/raise mixing head until it automatically locks in place.

Mixing Guide

SPEED SETTING	MIXING GUIDE	EXAMPLE
1	Fold-Kneaded	Use when mixing dry ingredients or when folding two portions of a recipe together, such as a beaten egg white into a batter. Use when directions call for LOW speed. Use for kneading bread.
2	Stir	Use when stirring liquid ingredients or when gentle action is needed to moisten dry ingredients.
3	Blend	Use when quick breads require a brisk action, just enough to blend ingredients but not enough to develop a smooth batter.
4	Mix	Use when mixing dry ingredients and liquid ingredients together alternately in a recipe.
5	Combine	Use when recipe calls for combining ingredients together.
6	Cake Mixes	Use when preparing packaged cake mixes or when directions call for MEDIUM speed.
7	Cream	Use when creaming sugar and butter together.
8	Whip	Use to whip potatoes or to develop a smooth batter.
9	Whip/Cream	Use to whip whipping cream or to develop a light, fluffy texture.
10	Desserts	Use to beat air into whipped desserts.
11	Frostings	Use when preparing light, fluffy frostings and candies.
12	Egg Whites	Use when aerating eggs and egg whites. Use when directions call for HIGH speed.

NOTE: Due to variations in ingredient temperatures and quantities, the Mixing Guide speeds are only suggested. If necessary, adjust speeds as needed to achieve desired results.

Caring For Your Mixer

EJECTING THE BEATERS OR DOUGH HOOKS

After you've finished mixing, turn the speed control dial to OFF and unplug the electric cord from the electrical outlet. Push the ejector button located beside the handle to remove beaters or dough hooks.

Scrape excess batter off the beaters using a rubber or plastic spatula. Do not strike beaters on the rim of the bowl.

Cleaning Your Mixer

1. Always turn off and unplug Mixer from electrical outlet before ejecting the attachments.
2. Wash attachments in hot, soapy water; rinse and dry.
3. Wipe the Mixer body and cord with a clean, damp cloth.

NOTES:

- Do not use abrasive cleaners or scouring pads as they may mar the finish of the Mixer.
- To reduce the risk of electrical shock, do not immerse the Mixer body or cord in water or other liquid.
- Beaters and bowls may also be washed in an automatic dishwasher.

Storing Your Mixer

Store the Mixer in a dry location, such as on a countertop or table top, or in a closet or cupboard. Insert the beaters into the proper sockets. Place the dough hooks in the mixing bowl.

Store the bowl(s) on the turntable. The beaters will help hold the bowl in position.

MAINTENANCE

The motor of your stand Mixer has been carefully lubricated at the factory and does not require any additional lubricant. Other than the recommended cleaning, no further user maintenance should be necessary. **There are no user serviceable component in this Mixer. Do not attempt to disassemble.**

Helpful Hints

MIXING AND BAKING SUGGESTIONS

- Ingredients should be added to the mixing bowl as they are specified in the recipe. When combining dry and wet ingredients, you may wish to moisten ingredients on Speed 1 or 2, then turn to the desired mixing speed.
- Use the mixing speed that is recommended in the recipe. Use the handy mixing guide on the speed control dial of the Mixer to help you find the correct speed to use.
- If times are specified in the recipe, use them. **BE CAREFUL NOT TO OVER MIX.** Over mixing can cause the mixture to become very tough.
- Should an object, such as a spatula, fall into the bowl while the Mixer is operating, turn the mixer OFF immediately. Then, remove the object.
- Remove beaters and place in sink for easy clean up.
- **DO NOT** exceed 3-1/2 cups of flour in any recipe as this will exceed the capacity of several unit components and may cause the motor to overheat.

Breads

SPECIAL INSTRUCTIONS FOR MAKING KNEADED BREADS

When making kneaded breads, your Mixer will require more care than when making ordinary mixtures, such as cake batter and cookie dough. The elasticity of the bread dough and the shape of the dough hooks may cause your Mixer to do some unusual things.

The bowl may tend to rock back and forth. We suggest that you guide the outside of the bowl with one hand to help control the rocking action. **AVOID GETTING YOUR HANDS TOO NEAR THE DOUGH HOOKS.**

The kneading action may cause the Mixer to slide on a slippery work surface. Be sure the work surface and rubber feet on the bottom of the Mixer are clean and dry.

CAUTION: DO NOT use the mixer too near the edge of a table or counter top, where it could fall off.

Using Dough Hooks

DO NOT LEAVE YOUR MIXER UNATTENDED WHILE USING THE DOUGH HOOKS.

Ingredients should be added to the mixing bowl as they are specified in the recipe.

Combine a small portion of the dry ingredients with the wet ingredients. Mix on Speed 6. Continue adding dry ingredients until the mixture becomes sticky, then turn to Speed 1. Gradually add remaining dry ingredients.

If there is high humidity in the air, it may be necessary to add additional flour to the recipe. The high humidity could also extend the amount of time necessary for baking.

Guide the mixing bowl with your hands. Use caution to keep hands out of the way of the dough hooks.

DO NOT attempt to scrape the bowl while the Mixer is operating. Stop the Mixer and scrape the sides of the bowl as necessary. Use a rubber or plastic spatula only.

DO NOT attempt to feed dough into the dough hooks with your hands, a spatula or any other utensil while the Mixer is plugged into an outlet or in operation.

If times are specified in the recipe, use them. **BE CAREFUL NOT TO OVER MIX.** Over mixing can cause the mixture to become tough. We suggest the maximum mixing time should be 6-8 minutes.

Should an object, such as a spatula, fall into the bowl while the mixer is operation, turn the mixer OFF immediately. Then remove the object. Remove dough hooks and place in sink for easy clean up.

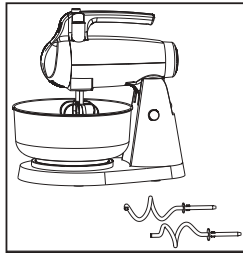

DOUGH RISING TIPS

A large, well-greased, glass mixing bowl is an excellent container in which to raise yeast dough. The ideal temperature is 85°F/30°C in an area that is draft free. Cover with a light cloth. The final rising should be after the dough has been shaped and placed on a greased baking sheet or pan recommended in the recipe. Again, cover the rising dough and place in a warm, draft-free area. If you live in a high altitude area, yeast breads will require a shorter rising time. Allow the dough to rise only until it has doubled in size. Slightly less flour should be used because flour is dryer at higher altitudes.

Customer Assistance

If you have a claim under this warranty, please call our Customer Assistance Number. For faster service please have model, series, and type numbers ready for operator to assist you. These numbers can be found on the bottom of your Stand Mixer.

MODEL: _____ **TYPE:** _____ **SERIES:** _____

Customer Assistance Number 1-877-207-0923

Keep this number for future reference!

TWO-YEAR LIMITED WARRANTY

What does your warranty cover?

- Any defect in material or workmanship.

For how long after the original purchase?

- Two years.

What will we do?

- Provide you with a new one.

How do you make a warranty claim?

- Save your receipt.
- Properly pack your unit. We recommend using the original carton and packing materials.
- Return the product to your nearest WAL★MART store or call Customer Assistance at 1-877-207-0923.

What does your warranty not cover?

- Glass parts, glass containers, cutter/strainer, blades and/or agitators.
- Commercial use or any other use not found in printed directions.
- Damage from misuse, abuse, or neglect.
- Products purchased or serviced outside the USA.

How does state law relate to this warranty?

- This warranty gives you specific legal rights, and you may also have other rights which vary from state to state.
- WAL★MART expressly disclaims all responsibility for consequential damages or incidental losses caused by use of this appliance. Some states do not allow this exclusion or limitation of incidental or consequential losses so the foregoing disclaimer may not apply to you.

What if you purchased your product in the U.S., Canada or Mexico and encounter a problem while using it outside the country of purchase?

- The warranty is valid only in the country of purchase and if you follow the warranty claim procedure as noted.

 is a trademark of General Electric Company and is used under the license by WAL★MART Stores Inc. Bentonville, AR 72716