

Hamilton Beach®

Food Processor

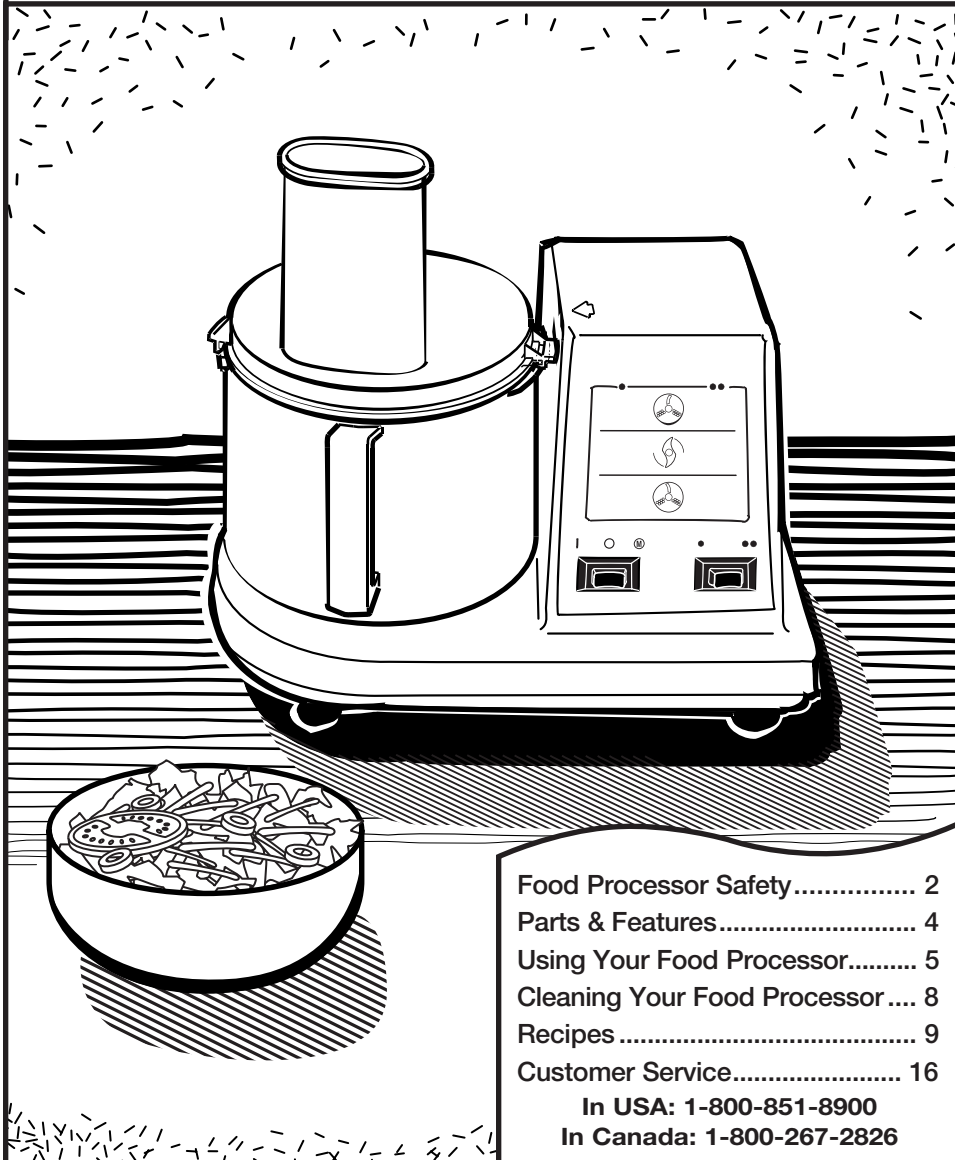

Food Processor Safety.....	2
Parts & Features.....	4
Using Your Food Processor.....	5
Cleaning Your Food Processor	8
Recipes	9
Customer Service.....	16

In USA: 1-800-851-8900

In Canada: 1-800-267-2826

840067300

Food Processor Safety

IMPORTANT SAFEGUARDS

When using electrical appliances, basic safety precautions should always be followed, including the following:

1. Read and save all instructions.
2. To protect against risk of electrical shock, do not immerse base, motor, cord, or plug in water or other liquid.
3. Close supervision is necessary when using this appliance near children.
4. This appliance should not be used by children.
5. Unplug cord from outlet when not in use, before putting on or taking off parts, and before cleaning.
6. Avoid contacting moving parts. Keep fingers out of discharge opening.
7. Do not operate any appliance with a damaged cord or plug or after the appliance malfunctions or is dropped or damaged in any manner. Call our toll-free customer service number for information on examination, repair or electrical or mechanical adjustment.
8. The use of attachments not recommended or sold by Hamilton Beach/Proctor-Silex, Inc. may cause fire, electric shock, or injury.
9. Do not use your food processor if any part is broken.
10. Do not use appliance outdoors.
11. Do not let cord hang over edge of table or counter, or touch hot surfaces.
12. Never feed food into food chute by hand when slicing or shredding food. Always use food pusher.
13. The blade and disc are sharp. Handle carefully. Store out of reach of children.
14. Make sure the blade or disc has come to a full stop before removing cover.
15. Be certain cover is securely locked in place before operating appliance.
16. To reduce the risk of injury, never place cutting blade or disc on base without first putting bowl properly in place.
17. Keep hands and utensils away from moving blade and disc while processing food to reduce the risk of severe personal injury and/or damage to the food processor. A rubber scraper may be used but ONLY when the food processor is not running.
18. Do not attempt to defeat the cover interlock mechanism.
19. To reduce the risk of injury, be sure to insert or remove blade and disc using hubs provided for this purpose. Use caution when removing blade and disc from the bowl, when emptying the bowl, and when cleaning.
20. Be sure to turn switch to OFF position after each use. Always use the pusher to clear the food chute. When this method is not possible, turn the motor off and disassemble unit to remove the remaining food.
21. The appliance is not intended for commercial, professional or industrial use. It is designed and built exclusively for domestic use only.
22. Never use appliance for a longer period or with a larger amount of ingredients other than that recommended by Hamilton Beach/Proctor-Silex, Inc.
23. The maximum rating of this unit is based on using the S-Blade. Using the Slicing/Shredding Disc may draw significantly less power.
24. Do not place on or near a hot gas or electric burner or in a heated oven.
25. Do not use appliance for other than intended use.

SAVE THESE INSTRUCTIONS!

Consumer Safety Information

This appliance is intended for household use only.

This appliance is equipped with a polarized plug. This type of plug has one blade wider than the other. The plug will fit into an electrical outlet only one way. This is a safety feature intended to help reduce the risk of electrical shock. If you are unable to insert the plug into the outlet, try reversing the plug. If the plug should still fail to fit, contact a qualified electrician to replace the obsolete outlet. Do not attempt to defeat the safety purpose of the polarized plug by modifying the plug in any way.

To avoid an electrical circuit overload, do not use another high wattage appliance on the same circuit with your food processor.

The length of the cord used on this appliance was selected to reduce the hazards of becoming tangled in, or tripping over a longer cord. If a longer cord is necessary, an approved extension cord may be used. The electrical rating of the extension cord must be equal to or greater than the rating of the food processor. Care must be taken to arrange the extension cord so that it will not drape over the countertop or tabletop where it can be pulled on by children or accidentally tripped over.

Before First Use

Unpack processor. Handle the S-Blade and Slicing/Shredding Disc carefully; they are very sharp.

Wash all parts except the base in hot, soapy water. Rinse then dry. These parts can also be placed in the dishwasher.

Processing Tips and Techniques

- For a uniform consistency when chopping, leave room in the bowl for the food to be tossed around.
- Also for a more uniform consistency, start with pieces of food that are similar in size. Carrots, for example, should all be cut in 1-inch chunks. Do not process 4-inch pieces with ½-inch pieces.
- This food processor is excellent to chop, mix, slice, or shred most foods. However, to maintain peak performance, we do not recommend the following: grinding grain, coffee beans or spices; slicing frozen meat; or crushing ice.
- Do not puree or mash starchy vegetables like potatoes. They will be overprocessed in a second and turn gummy.
- Operating time will depend on quantity of food being processed. Most foods can be sliced, chopped, or shredded in seconds. Do not operate processor for more than one minute at a time. If processing large quantities, let the processor rest about one minute before continuing.

Using Your Food Processor

Hints!

- The bowl will hold 6 to 7 cups of dry ingredients or 2 cups of liquid. Do not overfill.
- Do not use your food processor to crush ice.
- For consistent texture, foods should be cut into 1-inch cubes before mincing or chopping with the S-Blade.

NOTE: Always lock the bowl onto base before putting on any blade or disc. Make sure blade or disc is securely in place before using.

How to Lock the Bowl

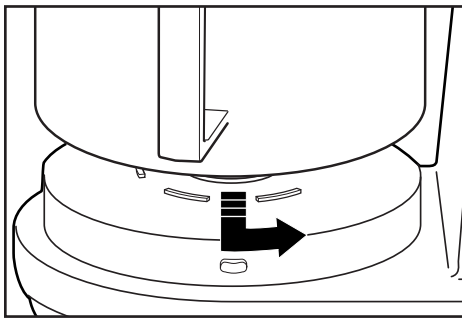

Place bowl onto the base with handle facing you. Rotate the bowl counter-clockwise until it locks into place.

How to Lock the Cover

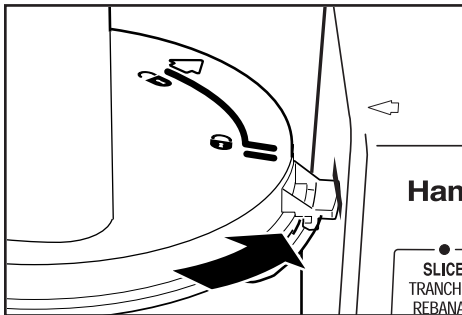

Place cover on bowl with "Unlock" arrow on cover aligned with arrow on control panel. Turn the cover counter-clockwise until "Lock" symbol aligns with arrow on control panel. Turn until you hear the cover lock into place.

Processing Using S-Blade



The S-Blade can be used to coarsely chop, finely mince, mix, or puree food to a smooth consistency.

1. Make sure the Control Switch is turned to OFF (O) and the unit is unplugged.
2. Lock the bowl onto base. (See “How to Lock the Bowl” on page 5.)
3. Place the S-blade onto motor shaft of food processor in center of bowl. Turn slowly until blade drops into place. **Handle carefully; the blade is sharp.**

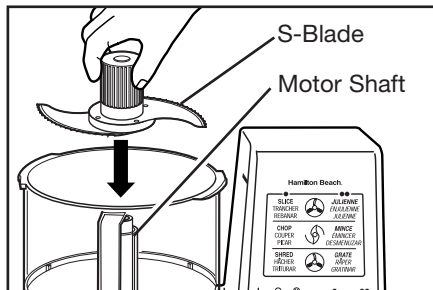

4. Lock cover onto bowl. (See “How to Lock the Cover” on page 5.) Insert food pusher into food chute.
5. Plug in unit and process food. The processing speed and time will determine the finished consistency of the food. The Pulse (M) button can help you avoid overprocessing.

Processing Using Slicer/Shredder



- To slice or shred cheese, select firm cheese like cheddar, monterey jack, or swiss. Place cheese in freezer for one hour before processing.
- The Reversible Slicer/Shredder Disc has a slicing blade on one side and shredding teeth on the other. Place on disc shaft with desired cutting edge facing up.
- To julienne vegetables, slice then remove from bowl and restack the vegetables. Pack into food chute with slices vertical. Slice again to make match-stick cut vegetables.

1. Make sure the Control Switch is turned to OFF (O) and the unit is unplugged.
2. Lock the bowl onto base. (See “How to Lock the Bowl” on page 5.)
3. Place disc shaft on the motor shaft.

4. Put Slicer/Shredder Disc on disc shaft with the desired side facing up for either slicing or shredding. Lock cover onto bowl. (See “How to Lock the Cover” on page 5.)

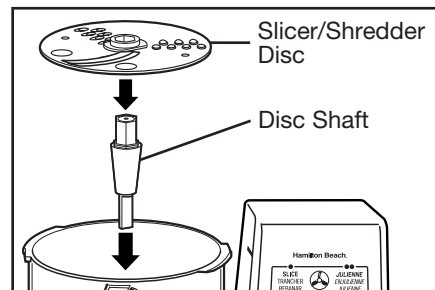

- Cut food to fit food chute. Pack food chute tightly with food. Insert food pusher in chute. **Always use the food pusher to feed food into the chute. NEVER PUSH FOOD THROUGH CHUTE WITH HANDS.**
- Plug in unit and process food.
- Select speed. While pressing on food pusher, push ON (I) or PULSE (M) to process food.
- When food chute is empty, push OFF (O) or release from PULSE (M) position. **Wait until blade has stopped rotating before removing cover.**

How to Operate the Controls

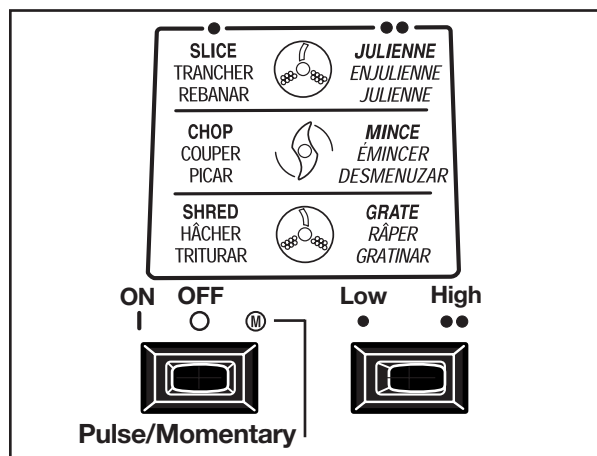



The control panel provides quick-reference graphics which indicate the correct blade or disc for a job:

Speed Switch: Push the switch to either Low (•) or High (••) speed before turning on the motor with the control switch.

Control Switch: This switch gives you three choices: ON (I), OFF (O) or PULSE/MOMENTARY (M).

Selecting the ON (I) position will cause the motor to run continuously until you push the switch to OFF (O). The PULSE/MOMENTARY (M) position will cause the motor to run only until you release the switch; then it automatically springs back to the OFF (O) position.

Processing Charts

ATTACHMENT	SPEED	FOODS
Slicer disc (slicing blade facing up) 	Low (●)	Cucumbers, apples, mushrooms
	High (●●)	Julienne vegetables
S-Blade 	Low (●)	Chop nuts, mince vegetables
	High (●●)	Chop meat, puree food
Shredder disc (shredding teeth facing up) 	Low (●)	Cabbage
	High (●●)	Firm cheeses

Operating time will depend on quantity of food being processed. Most foods can be sliced, chopped, or shredded in 11 to 30 seconds. Do not operate processor for more than one minute at a time. If processing large quantities, let processor rest about one minute before continuing.

FOOD	MAXIMUM AMOUNT
Fruits and Vegetables	1 pound or 2 to 3 cups
Meats	12 ounces or 1½ cups, cubed
Parmesan or Romano Cheese	5 ounces, cubed
Cheddar, Jack, or Mozzarella Cheese	8 ounces, cubed

For best results do not exceed these amounts when chopping, mincing, or pureeing with the **S-blade**.

Cleaning Your Food Processor

1. Wash the bowl, cover, blade, disc, and food pusher in hot, soapy water. Rinse and dry thoroughly. These parts may also be washed in a dishwasher.
NOTE: Do not store the food processor with the cover in the locked position, as this may put strain on the interlock tab.
2. Wipe the base, control panel, and cord with a damp cloth or sponge. To remove stubborn soil, use a mild non-abrasive cleanser.
NEVER IMMERSE THE BASE IN WATER OR OTHER LIQUID.
3. To store, place bowl on base. Then place onto the motor shaft the S-blade and slicing/shredding disc. Place cover on bowl but do not lock.

Recipes

Blue Cheese Dressing

2 cloves garlic	½ cup sour cream
4 ounces blue cheese	¼ cup fresh lemon juice
2 cups mayonnaise	2 tablespoons sugar

Using S-blade, with processor running, drop the garlic cloves into the food chute and mince. Add cheese and process for 10 seconds. Add mayonnaise, sour cream, lemon juice, and sugar. Process until smooth. Keep refrigerated.

Makes 3 cups.

Hummus

2 cloves garlic	2 teaspoons olive oil
2 green onions, white portion and half of green top	¼ teaspoon cumin
15 ounce garbanzo beans (chick peas), drained, reserving ¼ cup liquid	Dash of cayenne
¼ cup tahini (sesame paste), stirred	Salt and pepper to taste
3 to 4 tablespoons lemon or lime juice	Dash of paprika
	Pita bread or cut up vegetables, optional

Using S-blade and with processor running, drop garlic cloves and onion into food chute. Then add garbanzo beans, tahini, lemon or lime juice, olive oil, cumin, cayenne, salt, and pepper. Continue to process until smooth, scraping bowl as needed. Place into serving bowl and garnish with paprika. Serve with pita bread and/or vegetables. To store, refrigerate. **Makes about 2 cups.**

Salsa

1 onion, peeled and quartered	¼ cup cilantro, packed
1 clove garlic	½ teaspoon cumin
1 hot pepper (jalapeno or finger hot), cored, seeded and quartered	1 tablespoon lime juice
4 tomatoes, quartered	Salt and pepper to taste
	Hot sauce, optional

Using S-blade and with processor running, drop onion, garlic clove, and hot pepper through the food chute and chop until finely minced. Stop processor. Add tomatoes, cilantro, cumin, lime juice, salt, and pepper. Pulse until desired texture. Add hot sauce if desired. **Makes 2 to 3 cups.**

Cranberry Orange Relish

12 ounces fresh cranberries, stems removed or frozen	3 tablespoons Grand Marnier liqueur or orange juice
1 cup sugar	Dash of ground cloves
1 small navel orange, washed, cut into wedges	

Using S-blade, place cranberries, sugar, orange, Grand Marnier or orange juice, and cloves into the work bowl. Process until cranberries are almost smooth, yet a bit chunky. Cover and refrigerate overnight. This will thicken as it sits.

Makes about 2½ cups.

Chicken Puffs

1 pound cooked chicken, (1½ cups finely chopped)	½ teaspoon each, salt and celery seed
¼ cup packed parsley sprigs	¼ teaspoon each, dry mustard and onion powder
1 cup chicken broth	1 cup flour
½ cup vegetable oil	4 eggs
1 tablespoon Worcestershire sauce	

Cut chicken in large chunks and using S-blade place chicken and parsley in work bowl and pulse until finely chopped. Remove and set aside. In a large saucepan over high heat, mix chicken broth, oil, and Worcestershire sauce. Bring to a boil. Stir the four seasonings into flour. When broth reaches a boil, add flour all at once. Stir until the dough forms a ball. Place dough into mixing bowl. Add eggs one at a time, mixing well after each egg. Stir in chicken and parsley. Drop by spoonfuls, size of golf ball, onto baking sheet. Bake at 450°F for 12 to 15 minutes.

Makes 4 dozen.

Potato-Leek Soup

3 pounds potatoes, peeled	1½ teaspoons salt
3 to 4 leeks, both root and leaf ends trimmed	¼ teaspoon pepper
8 ounces bacon	½ cup milk
2 quarts water	3 tablespoons flour

Using slicer/shredder disc, slicing side up, slice potatoes. Remove to large mixing bowl and cover with cold water. Set aside. Slice leeks. To clean leeks, place in a colander and toss gently under running water. In a soup pot or Dutch oven, cook bacon until crisp. Remove bacon and set aside. Add the leeks to the bacon grease in the pot. Cook and stir occasionally over medium heat for about 10 minutes.

Increase heat to high and add water, potatoes, salt, and pepper. Bring soup to a boil then reduce heat and simmer, uncovered, for 15 to 20 minutes. In a small bowl, whisk together milk with flour. Slowly stir milk mixture into simmering soup and simmer for 5 minutes. Garnish with crumbled bacon bits. **Makes 6 to 8 servings.**

Lentil Soup

½ pound bacon	16 ounce bag lentils
1 large onion	2 quarts water
6 parsnips, peeled, ends removed, cut into 1-inch pieces	1 bay leaf
8 celery ribs with leaves	1 teaspoon salt
6 carrots, ends removed	Sour cream, optional

In a soup pot or Dutch oven, cook bacon until crisp. Remove and reserve four slices of bacon to be used as garnish. Leave bacon drippings in pot. Using S-blade, chop onions and parsnips. Add chopped onions and parsnips to bacon drippings in pot and cook over medium heat until softened, about 7 minutes. Using slicer/shredder disc, slicing side up, slice celery and carrots. Add the celery, carrots, lentils, water, bay leaf, and salt to onion mixture. Bring to boil then reduce heat and simmer, covered, for 40 minutes. At serving time, garnish with sour cream and crumbled bacon. **Makes 8 servings.**

NOTE: Lentils do not need to be soaked overnight.

Creamed Potatoes

4 pounds all-purpose white potatoes, about 15 medium
3 cups half-and-half cream
3 tablespoons finely minced onion
1½ teaspoons salt
¼ teaspoon pepper
4 tablespoons butter, melted

Scrub the potatoes but do not peel. Place in a large pot and cover with water. Bring to boil then reduce heat and simmer for 45 minutes or until done. Refrigerate overnight. Using slicer/shredder disc, shredding side up, grate the potatoes. It is not necessary to peel them. Place grated potatoes, half-and-half, onion, salt, and pepper in a large bowl and stir to mix. Put butter in a 9x13-inch baking dish and rotate dish to coat. Spoon in potato mixture. Bake at 375°F for 1 hour. **Makes 10 servings.**

Sweet Potato Pudding

1 to 1¼ lb. sweet potatoes, scrubbed but not peeled, and cut to fit food chute (3 cups grated)
½ cup sugar
¼ cup maple syrup
1 cup milk
1 egg
¼ cup butter
1 teaspoon vanilla

Using slicer/shredder disc, shredding side up, grate sweet potatoes. Remove from work bowl and place in medium mixing bowl. Set aside. Using S-blade, place sugar, syrup, milk, egg, butter, and vanilla into work bowl. Process until smooth. Pour over shredded sweet potatoes. Mix thoroughly. Pour into greased 1½ quart casserole dish. Place casserole dish into a larger pan or dish. Add hot water to larger pan, so water will be 1 to 2-inches up side of casserole dish. This will prevent the edges from burning. Bake at 350°F for 1½ hours. **Makes 6 servings.**

Vegetable Lasagna

8 ounces reduced-fat mozzarella cheese
1 medium onion, peeled, cut into chunks
4 garlic cloves
4-6 ounces fresh mushrooms
1 teaspoon vegetable oil
2 zucchini, approximately 6 inches each, cut into chunks
2 ounces Parmesan cheese, cut into ½-inch chunks (about ⅓ cup grated)
8-ounce package light cream cheese, cut into chunks
¾ cup skim milk ricotta cheese
½ cup light sour cream
1 egg
2 teaspoons dried Italian seasoning
26 ounce can spaghetti sauce
6 lasagna noodles, cooked

Using slicer/shredder disc, shredding side up, shred mozzarella. Place in a small bowl and set aside. Using S-blade, place onion and garlic cloves into work bowl. Pulse until coarsely chopped. Add mushrooms to bowl. Continue to pulse until mushrooms are coarsely chopped. Place chopped vegetables in a large skillet with oil, over medium heat. Using S-blade, place zucchini in work bowl. Pulse until coarsely chopped. Add zucchini to skillet. Cook until tender, about 10 minutes;

set aside. Without washing the work bowl, using S-blade, place Parmesan cheese chunks in bowl and process on High until coarsely chopped. Add the cream cheese, ricotta cheese, sour cream, egg, and Italian seasonings and process until creamy, about 30 to 40 seconds. Grease a 9x13-inch baking dish. Layer half each of noodles, cream cheese mixture, chopped vegetable mixture, and spaghetti sauce. Repeat layers once. Sprinkle with mozzarella. Bake, covered, at 350°F for 25 minutes. Uncover and cook an additional 10 minutes. Let stand 10 minutes before serving. **Makes 8 servings.**

NOTE: Mozzarella cheese will shred easier if placed in freezer for one hour before shredding.

Lasagna

1 pound mozzarella cheese	8-ounce can tomato sauce
1 pound mild Italian sausage	2.5 ounces Parmesan cheese, cut in ½-inch cubes (½ cup grated)
1 pound ground beef	1 cup parsley sprigs
2 cloves garlic	1 pound small curd cottage cheese
1 medium onion, peeled and cut in eighths	15-ounce container Ricotta cheese
1 rib celery, cut in 2-inch pieces	2 eggs
26-ounce can spaghetti sauce	12 lasagna noodles, uncooked

Using slicer/shredder disc, with slicing blade up, slice mozzarella and set aside. Remove casings from sausage. In a large skillet or large, heavy saucepan over medium high heat, cook and crumble sausage and ground beef. Using S-blade, with processor running, drop garlic through food chute and mince. Stop processor. Add onion and celery. Pulse until chopped then add to skillet. Cook until onion is soft. Place cooked meats and vegetables in large bowl. Add spaghetti sauce and tomato sauce and stir to mix. Using S-blade, process Parmesan cheese on High until finely grated, about 20 seconds. Add parsley to the Parmesan and process until chopped. Add cottage cheese, ricotta, and eggs and process until blended. In a 9x13-inch baking dish, layer meat sauce, noodles, cheese mixture, then mozzarella slices. Repeat layers. (Can be refrigerated at this time.) Cover tightly with aluminum foil and bake at 350°F for 45 minutes. Remove foil and bake 15 to 30 minutes more. Let sit 10 minutes before cutting to serve.

Makes 8 to 10 servings.

Crispy Catfish Fillets

2½ ounces Parmesan cheese (½ cup, grated)	½ cup fresh parsley sprigs
20 buttery crackers, like Ritz or Townhouse	¼ cup melted butter
	4 catfish fillets, about 8 ounces each

Cut cheese into ½-inch cubes. Using S-blade, place cheese cubes, crackers, and parsley in work bowl. Process until finely ground. Place cracker mixture in large shallow bowl. Dip fillets in butter then place in cracker mixture to coat. Lay fillets on nonstick or aluminum foil-lined baking sheet. Bake at 400°F for 15-20 minutes.

Makes 4 servings.

Cashew Chicken

2 pounds boneless skinless chicken breasts	¼ cup pineapple juice
4 cloves garlic	3 tablespoons soy sauce
1-inch piece of ginger root, peeled	1 teaspoon dry mustard
1 bunch green onions, roots trimmed	1 cup roasted cashews
2 tablespoons vegetable oil	8-ounce can sliced water chestnuts, drained
1 tablespoon flour	Cooked rice
¾ cup chicken stock or broth	

Using S-blade, place chicken in bowl. Pulse until chicken is very coarsely chopped. Remove chicken and set aside. Do not wash work bowl. Place garlic and ginger in work bowl and pulse until minced. Add green onions, white part and 2-inches of green top, and pulse until chopped. Heat oil in skillet over medium high heat. Add the chopped vegetables and chicken to the skillet. Stir and cook about 7 minutes, or until chicken is done. Stir occasionally. Use a slotted spoon and remove chicken and vegetables. Sprinkle flour into skillet. Stir and cook until just beginning to turn brown, about 1 minute. Add chicken broth, pineapple juice, soy sauce, and mustard. Stirring frequently, bring to a boil and cook until thickened, about 5 minutes. Return chicken/vegetables to skillet, add cashews and water chestnuts. Heat through. Serve over rice. **Makes 6 servings.**

Roasted Sweet Peppers & Sausage

1 red bell pepper, cored and seeded	1 teaspoon dried oregano
1 yellow bell pepper, cored and seeded	2 tablespoons olive oil
2 green bell peppers, cored and seeded	2 pounds Italian sausage
2 medium onions, peeled and cut to fit in food chute	

Using a fork, pierce sausage casings several times. In a skillet over medium high heat, brown sausages, turning frequently, about 8 minutes. Set aside. Using the slicer/shredder disc, slicing side up, slice peppers and onion. Place in 2 quart baking dish. Add oregano and oil; stir to mix. Place sausage on peppers. Bake at 350°F for 45 minutes. Serve peppers and sausage with noodles or spoon onto toasted sub rolls. **Makes 6 servings.**

Good Morning Muffins

4 medium carrots (2 cups grated), washed, ends removed	1 tablespoon vanilla
1 large apple (1 cup grated), cored and cut into wedges	2 cups flour
3 eggs	2 teaspoons cinnamon
½ cup apple butter	1 teaspoon baking soda
¼ cup vegetable oil	½ teaspoon baking powder
1¼ cups sugar	½ teaspoon salt
	1 cup raisins

Using slicer/shredder disc, shredding side up, shred carrots and apple into work bowl. Remove from bowl; put into a large mixing bowl. Set aside. Using S-blade, place eggs, apple butter, oil, sugar, and vanilla into work bowl. Process until mixed and smooth. Add flour, cinnamon, baking powder, baking soda, salt, and raisins. Pulse until JUST mixed. Pour batter into mixing bowl with grated carrots/apple mixture. Spoon into greased or paper lined muffin tin, filling about ¾ full. Bake at 375°F for 15 to 20 minutes. **Makes 24 muffins.**

Cheddar Onion Cornbread

4 ounces Cheddar cheese (1 cup grated)	½ cup milk
1 small onion, peeled and cut in quarters	8-ounce package corn muffin mix
1 tablespoon butter	8-ounce can cream-style corn
1 egg	8-ounce container sour cream

Using slicer/shredder disc, shredding side up, shred Cheddar and set aside. Using S-blade, place onion in work bowl and process until finely chopped. Place chopped onion and butter in a skillet and cook over medium high heat until onions are soft. Set aside and cool. Do not wash work bowl. Using S-blade, place egg, milk, muffin mix, and corn into work bowl. Pulse until JUST mixed. Pour batter into greased 8-inch square baking pan. Combine onions, cheese, and sour cream. Place small spoonfuls of sour cream mixture on top of batter. Bake at 425°F for 30 to 35 minutes. **Makes 6-8 servings.**

Baked Pineapple Bread Pudding

12 slices of white bread, torn into strips to fit food chute	1 teaspoon vanilla
20 ounce can pineapple chunks, drained	1 tablespoon melted butter or margarine
2 eggs	1½ cups sugar
1 cup half-and-half cream	3 pineapple slices, drained

Insert S-blade into food processor bowl and, with processor running, drop bread through food chute to make soft breadcrumbs. Pour into a greased 2-quart casserole dish. Place pineapple chunks in food processor bowl with S-blade. Process pineapple for 20 seconds. Add eggs, cream, vanilla, melted butter or margarine, and sugar. Process until mixed. Pour pineapple mixture over soft breadcrumbs. Garnish with three pineapple rings overlapping in center. Bake at 350°F for 1 hour or until golden. **Makes 8 servings.**

Chocolate Chip Cheesecake

Filling:

3 8-ounce packages cream cheese,
cut into chunks
1 cup sugar
2 tablespoons flour
4 eggs
¼ cup milk
1 teaspoon vanilla
½ cup chocolate chips

Crust:

1 teaspoon butter, softened
22 chocolate chip cookies
3 to 4 tablespoons unsalted butter,
melted

Crust: Use 1 teaspoon butter to grease a 9 to 9½-inch springform pan and set aside. Using S-blade and with processor running, drop cookies through food chute and process until an even crumb is formed. Continue processing, adding melted butter through the food chute until mixed. Pour crumbs into prepared springform pan and press crumbs evenly on bottom of pan. Bake at 425°F for 10 minutes. Remove from the oven and cool on rack.

Filling: Using S-blade, add cream cheese, sugar, flour, eggs, milk, and vanilla to work bowl. Process until smooth. Pour filling over cooled crust and sprinkle with chocolate chips. Bake 15 minutes at 425°F. Reduce heat to 250°F and continue to bake (without opening the oven door) for 45 minutes more or until cheesecake is set. When cooled, cover and refrigerate several hours or overnight.

Makes 16 servings.

Cooking Tip: For a creamy smooth-textured cheesecake, bake it in a water bath. Tear off a sheet of aluminum foil that extends about 6 inches larger than the springform pan. Place springform pan in center of foil and form foil up around the sides. This prevents water from leaking into the pan. Place the springform pan in a larger pan and fill larger pan with about 1½ inches of hot tap water. Bake as directed.

Marissa's Apple Crisp

6 large Golden Delicious apples,
peeled and cored and cut to fit in
food chute (6 cups sliced)
1 tablespoon lemon juice
½ cup sugar
1 tablespoon flour
1 teaspoon cinnamon
¼ teaspoon nutmeg

Topping:

½ cup butter, melted
1 cup flour
1 cup sugar
1 teaspoon cinnamon

Using slicer/shredder disc, slicing side up, slice apples. Put apples in a large bowl. Drizzle lemon juice over apples. Sprinkle apples with sugar, flour, cinnamon, and nutmeg. Stir to mix, then put apples in ungreased 2-quart baking dish. Using S-blade, place topping ingredients in work bowl and pulse until mixed. Crumble topping over apples. Bake at 375°F for 30 minutes. Serve topped with vanilla ice cream. **Makes 6 servings.**

Customer Service

If you have a question about your food processor, call our toll-free customer service number. Before calling, please note the model, type, and series numbers and fill in that information below. These numbers can be found on the bottom of your food processor. This information will help us answer your question much more quickly.

MODEL: _____ **TYPE:** _____ **SERIES:** _____

TWO-YEAR LIMITED WARRANTY

Hamilton Beach/Proctor-Silex, Inc. warrants this appliance to be free from defects in material and workmanship for a period of two (2) years from the date of original purchase, except as noted. There is no warranty with respect to the following, which may be supplied with this appliance: glass parts, glass containers, cutter/strainer, blades and/or agitators. This warranty extends only to the original consumer purchaser and does not cover damage from abuse, neglect, use for commercial purposes, or any other use not found in the printed directions. HAMILTON BEACH/PROCTOR-SILEX, INC. EXPRESSLY DISCLAIMS ANY AND ALL IMPLIED WARRANTIES, INCLUDING WARRANTIES OF MERCHANTABILITY AND FITNESS FOR A PARTICULAR PURPOSE. ANY LIABILITY HEREUNDER IS EXPRESSLY LIMITED TO THE REPAIR OR REPLACEMENT OF A DEFECTIVE PRODUCT OR AN AMOUNT EQUAL TO THE PURCHASE PRICE PAID THEREFOR, AND ALL CLAIMS FOR SPECIAL AND CONSEQUENTIAL DAMAGES ARE HEREBY EXCLUDED. Some states or provinces do not allow this exclusion or limitation of incidental or consequential losses, so the foregoing disclaimer may not apply to you. If you have a claim under this warranty, DO NOT RETURN THE APPLIANCE TO THE STORE! Please call our CUSTOMER SERVICE NUMBER. (For faster service please have model, series, and type numbers ready for operator to assist you.)

CUSTOMER SERVICE NUMBERS

In the U.S. 1-800-851-8900

In Canada 1-800-267-2826

Web site address: www.hamiltonbeach.com

KEEP THESE NUMBERS FOR FUTURE REFERENCE!

This warranty gives you specific legal rights, and you may also have other legal rights which vary from state to state, or province to province.

HAMILTON BEACH ♦ PROCTOR-SILEX, INC.

263 Yadkin Road
Southern Pines, NC 28387

PROCTOR-SILEX CANADA, INC.

Picton, Ontario K0K 2T0

Web site address: www.hamiltonbeach.com

840067300

Printed In Mexico

8/00

17