

Contents

1.	<i>INSTRUCTIONS FOR SAFE AND PROPER USE</i>	4
2.	<i>INSTALLATION</i>	6
3.	<i>DESCRIPTION OF CONTROLS</i>	9
4.	<i>USE OF THE OVEN</i>	14
5.	<i>AVAILABLE ACCESSORIES</i>	15
6.	<i>COOKING HINTS</i>	16
7.	<i>CLEANING AND MAINTENANCE</i>	21
8.	<i>EXTRAORDINARY MAINTENANCE</i>	24



*INSTRUCTIONS FOR THE INSTALLER: these are intended for the **qualified technician** who must install the appliance, set it functioning and carry out an inspection test.*



INSTRUCTIONS FOR THE USER: these contain user advice, description of the commands and the correct procedures for cleaning and maintenance of the appliance.

Introduction

1. INSTRUCTIONS FOR SAFE AND PROPER USE



THIS MANUAL IS AN INTEGRAL PART OF THE APPLIANCE AND THEREFORE MUST BE KEPT IN ITS ENTIRETY AND IN AN ACCESSIBLE PLACE FOR THE WHOLE WORKING LIFE OF THE OVEN. WE ADVISE CAREFUL READING OF THIS MANUAL AND ALL THE INSTRUCTIONS THEREIN BEFORE USING THE OVEN. INSTALLATION MUST BE CARRIED OUT BY QUALIFIED PERSONNEL IN ACCORDANCE WITH THE REGULATIONS IN FORCE. THIS APPLIANCE IS INTENDED FOR DOMESTIC USES AND CONFORMS TO CURRENT **REGULATIONS IN FORCE**. THE APPLIANCE HAS BEEN BUILT TO CARRY OUT THE FOLLOWING FUNCTIONS: **COOKING AND HEATING-UP OF FOOD**. ALL OTHER USES ARE CONSIDERED IMPROPER. **THE MANUFACTURER DECLINES ALL RESPONSIBILITY FOR IMPROPER USE.**



DO NOT LEAVE THE PACKING IN THE HOME ENVIRONMENT. SEPARATE THE VARIOUS WASTE MATERIALS AND TAKE THEM TO THE NEAREST SPECIAL GARBAGE COLLECTION CENTRE.



IT IS OBLIGATORY FOR THE ELECTRICAL SYSTEM TO BE GROUNDED ACCORDING TO THE METHODS REQUIRED BY SAFETY RULES.



WHEN LINKING UP TO MAINS BY PLUG AND SOCKET, MAKE SURE THAT BOTH ARE COMPATIBLE AND CONNECT BY MEANS OF A POWER CABLE COMPLYING WITH APPLICABLE REGULATIONS. THE SOCKET MUST BE ACCESSIBLE AFTER THE APPLIANCE HAS BEEN BUILT IN. **NEVER UNPLUG BY PULLING ON THE CABLE.**



DO NOT OBSTRUCT VENTILATION OPENINGS AND HEAT DISPERSAL SLITS.



IMMEDIATELY AFTER INSTALLATION CARRY OUT A BRIEF INSPECTION TEST OF THE OVEN, FOLLOWING THE INSTRUCTIONS BELOW. SHOULD THE APPLIANCE NOT FUNCTION, DISCONNECT IT FROM THE SUPPLY AND CALL THE NEAREST TECHNICAL ASSISTANCE CENTRE. **NEVER ATTEMPT TO REPAIR THE APPLIANCE.**



ALWAYS CHECK THAT THE CONTROL KNOBS ARE IN THE "ZERO" (OFF) POSITION WHEN YOU FINISH USING THE OVEN.

Introduction



NEVER PUT INFLAMMABLE OBJECTS IN THE OVEN: THEY COULD BE ACCIDENTALLY LIGHTED AND CAUSE FIRES.



DURING USE THE APPLIANCE BECOMES VERY HOT. TAKE CARE NOT TO TOUCH THE HEATING ELEMENTS INSIDE THE OVEN.



THE I.D. PLATE WITH TECHNICAL DATA, REGISTRATION NUMBER AND BRAND NAME IS POSITIONED VISIBLY ON THE OVEN DOOR FRAME. **THE PLATE MUST NOT BE REMOVED.**



THIS APPLIANCE IS DESIGNED FOR COOKING FOOD AND IT SHALL NOT BE USED AS A SPACE HEATER.



DO NOT SPRAY AEROSOLS IN THE VICINITY OF THIS APPLIANCE WHILE IT IS IN OPERATION.



THE OVEN IS DESIGNED FOR USE BY ADULTS. DO NOT ALLOW CHILDREN TO GO NEAR OR PLAY WITH IT.



THIS APPLIANCE IS MARKED ACCORDING TO THE EUROPEAN DIRECTIVE 2002/96/EC ON WASTE ELECTRICAL AND ELECTRONIC EQUIPMENT (WEEE).

THIS GUIDELINE IS THE FRAME OF A EUROPEAN-WIDE VALIDITY OF RETURN AND RECYCLING ON WASTE ELECTRICAL AND ELECTRONIC EQUIPMENT.



BEFORE THE APPLIANCE IS PUT INTO OPERATION, ALL THE LABELS AND PROTECTIVE FILMS APPLIED INSIDE OR OUTSIDE MUST BE REMOVED.



The manufacturer declines all responsibility for damage to persons or things caused by non-observance of the above prescriptions or by interference with any part of the appliance or by the use of non-original spares.



2. INSTALLATION

2.1 Electrical connection



Check that mains voltage and power cable ratings are as per the indications provided on the label attached to the oven door frame.

This label must never be removed.



It is obligatory for the electrical system to be grounded according to the methods required by safety rules.



If a plug and socket connection is being used make sure that the plug and socket are compatible. Avoid use of adapters and shunts as these could cause overheating and risk of burns.



If a fixed connection is being used fit power line with an omnipolar circuit breaker with a contact opening gap equal to or greater than **3 mm** in an easily accessible position in proximity to the oven.



For operation on 230-250V~: use an H05RR-F / H05RN-F / H05V2V2-F type three-core cable (3 x 1.5 mm²).

The cable end to be connected to the appliance must be provided with an ground wire (yellow-green) at least 20 mm longer.

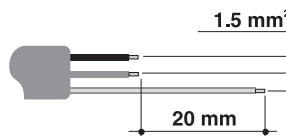

The manufacturer declines all responsibility for damage to persons or things caused by non-observance of the above prescriptions or by interference with any part of the appliance.



Instructions for the user

2.2 Mounting the oven

The oven is designed for mounting into any piece of furniture as long as heat-resistant. Proceed according to the dimensions shown in Figures 1, 2 and 3. For installing under a work top, follow the dimensions given in Figure 1-3. For installing under a work top with combined heating plates, ensure a minimum clearance from any side walls of at least 110 mm as shown in Figure 1.

For installing in a column, follow the dimensions given in Figure 1-2 allowing for a clearance of 80 to 90 mm at the top and sides of the column. Tighten the four screws **A** inside the frame to secure (Fig. 1).

For installing beneath a non-integrated top, allow for a rear and bottom clearance as shown in Figure 1 (ref. **B**). See relevant instructions for fitting and securing the cook top.

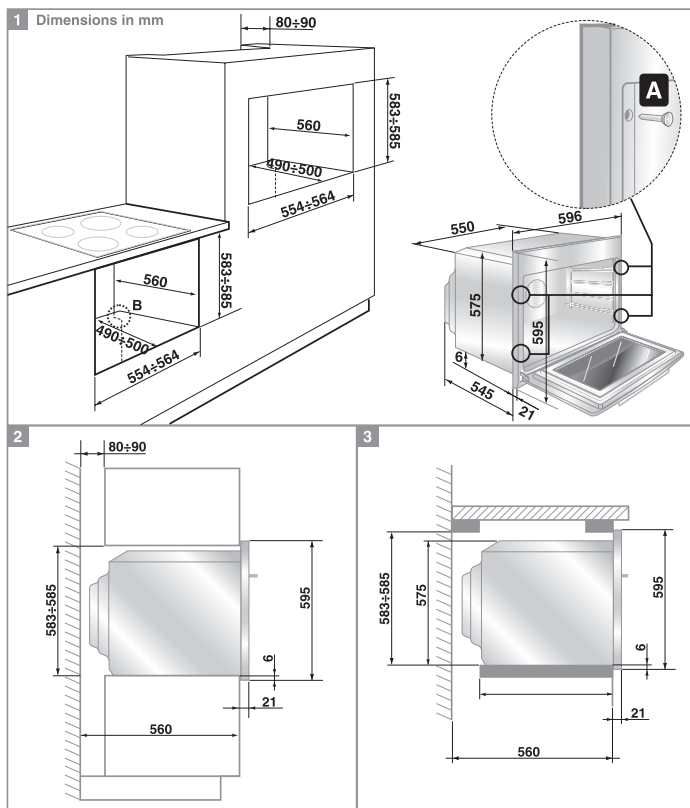

Instructions for the user



*Never use the oven door to lever the oven into place when fitting.
Avoid exerting too much pressure on the oven door when open.*





Instructions for the user

3. DESCRIPTION OF CONTROLS

3.1 Front control panel

All the oven controls are grouped together on the front panel.



FUNCTION SWITCH KNOB

Rotate the knob in either direction to select desired function from the following:

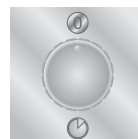

NO FUNCTION SET



GRILL ELEMENT IN OPERATION ALTERNATING WITH BOTTOM HEATING ELEMENT + FAN



UPPER AND LOWER HEATING ELEMENT



GRILL ELEMENT



WIDE GRILL ELEMENT



LOWER HEATING ELEMENT



WIDE GRILL ELEMENT + VENTILATION



UPPER AND LOWER HEATING ELEMENT + VENTILATION



UPPER AND LOWER HEATING ELEMENT + VENTILATED HEATING ELEMENT



VENTILATED HEATING ELEMENT



DEFROSTING



GRILL ELEMENT + VENTILATION



LOWER HEATING ELEMENT + VENTILATION

Instructions for the user



THERMOSTAT KNOB

Cooking temperature is selected by turning the knob clockwise to the desired setting, between 50° and 250°C.

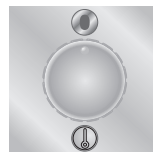

TIMER KNOB

Lets you choose manual cooking or the timer with automatic turn-off of the oven when done.

For manual control of cooking time, turn the knob anticlockwise to the symbol .

To set cooking time turn the knob clockwise.

The numbers from 5 to 120 correspond to minutes. Adjustment is progressive and intermediate positions between the numbers shown may be used.

At the end of the programmed cooking time, 1 bell will sound inside the timer.



3.2 Electronic Analogue Clock (on some models only)

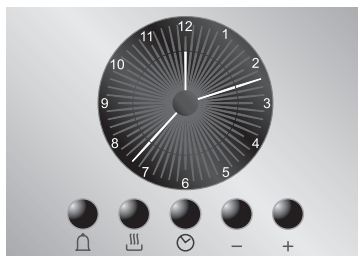

LIST OF FUNCTIONS



MINUTE-MINDER BUTTON



AUTOMATIC SWITCH-OFF TIMING BUTTON



TIME SETTING AND RESET



VALUE DECREASE BUTTON





VALUE INCREASE BUTTON



Instructions for the user

3.2.1 Setting the time





When the oven is used for the first time, or after a power blackout, the display flashes on and off at regular intervals. Press the  key for 1/2 seconds to stop the display flashing and start setting of the current time. Press the value modification keys  or  to increase or decrease by one minute for each time a key is pressed. Press one of the two value modification keys until the current time appears. The clock will start from the time set 6/7 seconds after the last key is pressed.



At the end of each programmed cooking operation, the clock gives 8 beeps, repeated 3/4 times at intervals of about 1 and a half minutes. The beeps can be stopped at any moment by pressing any key.

3.2.2 Minute-minder

This function does not stop cooking but just triggers the beeps.

- When the  key is pressed the display illuminates, appearing as shown in figure 1;
- Press the  or  keys within 6/7 seconds to set the minute-minder. Whenever a key is pressed, 1 outside segment, representing 1 cooking minute will light up (figure 2 shows 10 cooking minutes).
- The countdown will start 6/7 seconds after the last key is pressed; at the end of it, you will hear the beeps.
- During cooking with countdown, the current time can be displayed by pressing the  key once; press again to return to the minute-minder display.
- **At the end of the countdown, the oven has to be switched off by hand, by turning the thermostat and the function selector to 0.**



1









2



3.2.3 Programming

Cooking duration time: the 2nd button  can be used to set the cooking time. Before setting it, turn the thermostat to the cooking temperature of choice and the function selector knob to any setting. To set the cooking time, proceed as follows:

- Press the  key for 1/2 seconds; the pointer will move to position 12 (Fig. 1).
- Use the  and  keys to set the cooking time; whenever the  key is pressed, 1 minute will be added to the cooking time, and every 12 minutes a new inside segment will light up (figure 2 shows a cooking time of 1 hour).
- Once the required time has been set, cooking will start about 6 seconds after the last time the  or  key is pressed.
- Once cooking has started, the display will show the current time, represented by the constantly on segments, and the minutes left until cooking finishes, represented by the flashing segments (every flashing segment indicates 12 minutes of cooking time left).
- When the end of the cooking time is reached, the timer will switch off the oven heating elements, the beeps will start and the numbers on the dial will flash.
- The cooking time can also be reset by deleting the program set; pressing the central key  for 1 or 2 seconds will delete the time set and the oven will have to be switched off by hand.



1



2

Caution: cooking times of more than 6 hours cannot be set.



Instructions for the user

Cooking start: as well as setting a cooking duration time, the user can also set the cooking start time (up to 12 hours after the current time). To set the cooking start/end time, proceed as follows.

- Set the cooking duration time as described in the previous point.
- Within 6/7 seconds after the last time the **-** or **+** keys are pressed, press the **|||** key to set the cooking start time. The display will show the current time with the inside segments indicating the cooking end time illuminated. Use the **-** and **+** keys to set the cooking start time.
- 6/7 seconds after the last time a key is pressed, the display will show the current time and the cooking start and end times, indicated by the illuminated inside segments. The segments on the display will be constantly on until the current time is the same as the cooking start time set; as soon as the current time reaches the cooking start time set, all the inside segments will start to flash, indicating that the oven has started cooking.
- When the end of the cooking time is reached, the timer will switch off the oven heating elements, the beeps will start and the numbers on the dial will flash.
- To reset the entire program set, keep the central key  pressed for 1 or 2 seconds: if cooking has already started the oven will have to be switched off by hand.
- The image on the right shows an example of programming: the current time is 7.06 and cooking is programmed to start at 8 o'clock and finish at 9.
- At 8 o'clock, the inside segments between 8 and 9 will start to flash and the hour pointer will remain still.



Caution: for the oven to start cooking after the programming procedure just described, the thermostat and function selector must be properly set on the temperature and function required.

3.2.4 "DEMO" Function

Models with analogue/digital programmer feature a "DEMO" function which deactivates the heating elements while leaving the other functions unchanged. To activate it, simply press the **⏸**, **-** and **+** keys for 3/4 seconds. A confirmation beep will inform the user that the function is active. To deactivate it, simply repeat the same procedure.



4. USE OF THE OVEN



3 operations are required to switch the oven on:

1st: make sure that the timer is turned to ‘00’;

2nd: turn the thermostat;

3rd: turn the function selector to any function (the “lamp” setting does not switch on any heating elements).

In models equipped with analogue digital timer, the user has only to press the central key for 1/2 seconds to enable use of the oven on first use or after a power blackout.

4.1 Warnings and general advice

Before using the oven for the first time, pre-heat it to maximum temperature (250°C) long enough to burn any manufacturing oily residues which could give the food a bad taste.



During cooking, do not cover the bottom of the oven with aluminium or tin foil and do not place pans or oven trays on it as this may damage the enamel coating. If you wish to use greaseproof paper, place it so that it will not interfere with the hot air circulation inside the oven.



To prevent any steam in the oven creating problems, open the door in two stages: half open (5 cm approx.) for 4-5 seconds and then fully open. To access food, always leave the door open as short a time as possible to prevent the temperature in the oven from falling and ruining the food.



4.2 Cooling system

The oven features cooling fan which switch on together with the oven.

Fan operation causes a normal flow of air which exits at the bottom part of the oven front which may continue for a brief period of time even after the oven has been turned off.

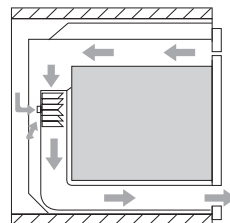

4.3 Oven light

On all models, it is switched on by turning the thermostat knob and the function selector knob to any function. On some models it also switches on when the oven door is opened.



Instructions for the user

5. AVAILABLE ACCESSORIES

The oven features **4 support** positions for plates and racks of different height.



Some models do not feature all accessories.

Grill: useful for holding cooking vessels.



Plate grill: for placing above plate for cooking foods that might drip.



Oven plate: useful for catching fat from foods on the grill above.

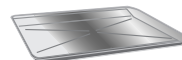

Pastry plate: for baking cakes, pizza and oven desserts.



Top guard: suitable for preventing overheating of the control panel when cooking with door open.

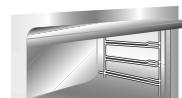

Chromium-plated tubular gripper for removing hot racks and plates from the oven.



Accessories available on request

Original accessories may be ordered from any Authorised Service Centre.

Instructions for the user



6. COOKING HINTS



In fan-assisted mode preheating should be carried out at 30/40°C above the cooking temperature. This considerably shortens cooking times and reduces power consumption, as well as giving better cooking results.



Keep the oven door closed during cooking

6.1 Traditional cooking



FUNCTION SWITCH



THERMOSTAT SWITCH

50 ÷ 250°C



This traditional cooking method, in which heat comes from above and below, is suitable for cooking food on a single level. You have to pre-heat the oven until the set temperature is reached. Place the food in the oven only after the thermostat indicator light has turned off. Very fatty meats may be put in when the oven is still cold. Put frozen meat in immediately, without waiting for it to thaw. The only precaution you need to take is to set the temperature about 20°C lower and cooking time about 1/4 longer than you would for fresh meat.

6.2 Hot-air cooking



FUNCTION SWITCH



THERMOSTAT SWITCH

50 ÷ 250°C



This system is suitable for cooking on several levels, including different types of food (fish, meat etc.), without the tastes and smells mingling. Air circulation in the oven ensures a uniform distribution of heat. Pre-heating is not necessary.



Instructions for the user



Multiple cooking is possible as long as the cooking temperature of the different foods is the same.

6.3 Grill cooking



FUNCTION SWITCH



THERMOSTAT SWITCH

250



Permits rapid browning of foods. You are advised to place the pan in the highest guide. For short-term cooking of small quantities, place the grid in the fourth guide from the bottom. For long-term cooking and grills, put the grid in the lowest guide in accordance with the size of the pieces.

Keep the oven door closed during cooking.

6.4 Hot-air grilling



FUNCTION SWITCH



THERMOSTAT SWITCH

220



Ensures uniform heat distribution with greater heat penetration into the food. Food will be lightly browned on the outside and remain soft inside.

Keep the oven door closed during cooking. Heating up time must not exceed 60 minutes.

Instructions for the user



6.5 Defrosting



FUNCTION SWITCH



THERMOSTAT SWITCH IN POSITION

0



The flow of air produced by the fan ensures quicker defrosting.
The air circulating inside the oven is at room temperature.



The advantage of defrosting at room temperature is that it does not alter the taste and appearance of the food.



Instructions for the user

6.6 Recommended cooking table

Cooking times, especially meat, vary according to the thickness and quality of the food and to consumer taste.

TRADITIONAL COOKING



	LEVEL FROM BELOW	TEMPERATURE (°C)	TIME IN MINUTES (*)
FIRST COURSES			
LASAGNE	2 - 3	210 - 230	30
OVEN-BAKED PASTA	2 - 3	210 - 230	40
MEAT			
ROAST VEAL	2	170 - 200	30 - 40 / KG.
ROAST BEEF	2	210 - 250	30 - 40 / KG.
ROAST PORK	2	170 - 200	30 - 40 / KG.
CHICKEN	2	170 - 200	45 - 60
DUCK	2	170 - 200	45 - 60
GOOSE - TURKEY	2	140 - 170	45 - 60
RABBIT	2	170 - 200	50 - 60
LEG OF LAMB	2	170 - 200	40 - 50
FISH	1 - 2	170 - 200	ACCORDING TO DIMENSIONS
PIZZA	1 - 2	210 - 250	40 - 45
DESSERTS			
SHORT PASTRY	1 - 2	170 - 200	15 - 20
CIAMBELLA	1 - 2	165	35 - 45
BRIOCHES	1 - 2	170 - 200	40 - 45
FRUIT CAKE	1 - 2	170 - 200	20 - 30
PARADISE CAKE	1 - 2	170	60
APPLE CAKE	1 - 2	190	60
RICE CAKE	1 - 2	180	60

(*) = WITH PREHEATED OVEN

GRILLING



	LEVEL FROM BELOW	TIME IN MINUTES	
		FIRST SURFACE	SECOND SURFACE
PORK CHOPS	4	7 - 9	5 - 7
FILLET OF PORK	3	9 - 11	5 - 9
FILLET OF BEEF	3	9 - 11	9 - 11
LIVER	4	2 - 3	2 - 3
VEAL ESCALOPE	4	7 - 9	5 - 7
HALF CHICKEN	3	9 - 14	9 - 11
SAUSAGES	4	7 - 9	5 - 6
MEAT-BALLS	4	7 - 9	5 - 6
FISH FILLETS	4	5 - 6	3 - 4
TOAST	4	2 - 4	2 - 3

Instructions for the user



HOT-AIR COOKING



	LEVEL FROM BELOW	TEMPERATURE (°C)	TIME IN MINUTES
FIRST COURSES			
LASAGNE	2	190 - 210	20 - 25
OVEN-BAKED PASTA	2	190 - 210	25 - 30
CREOLE RICE	2	190 - 220	20 - 25
MEAT			
ROAST VEAL	2	150 - 170	65 - 90
ROAST PORK	2	150 - 160	70 - 100
ROASTED BEEF	2	160 - 170	65 - 90
FILLET OF BEEF	2	160 - 180	35 - 45
ROAST LAMB	2	130 - 150	100 - 130
ROAST BEEF	2	170 - 180	40 - 45
ROAST CHICKEN	2	170	70 - 90
ROAST DUCK	2	160 - 170	100 - 160
ROAST TURKEY	2	150 - 160	160 - 250
ROAST RABBIT	2	150 - 160	80 - 100
ROAST HARE	2	160 - 170	30 - 50
ROAST PIGEON	2	140 - 170	15 - 25
FISH	2 - 3	150 - 170	ACCORDING TO DIMENSIONS
PIZZA	2 - 3	210 - 250	30 - 50
BREAD	2 - 3	190 - 210	40
TOAST	1 - 2	220 - 250	7
DESSERTS			
CIAMBELLA	2 - 3	150 - 170	35 - 45
FRUIT CAKE	2 - 3	170 - 190	40 - 50
BRIOCHEs	2 - 3	160 - 170	40 - 60
SHORT PASTRY	2 - 3	170 - 180	20
RICE CAKE	2 - 3	170	60
APPLE CAKE	2 - 3	180	60
PARADISE CAKE	2 - 3	160	60



Instructions for the user

7. CLEANING AND MAINTENANCE



Before performing any operations requiring access to powered parts, switch off the power supply to the machine.

7.1 Cleaning stainless steel



To keep stainless steel in good condition it should be cleaned regularly after use. Let it cool first.

7.1.1 Ordinary Daily Cleaning

To clean and preserve the stainless steel surfaces, always use **only** specific products that do not contain abrasives or chlorine-based acids.

How to use: pour the product on a damp cloth and wipe the surface, rinse thoroughly and dry with a soft cloth or deerskin.

7.1.2 Food stains or residues

Do not use metallic sponges or sharp scrapers: they will damage the surface.

Use normal non-abrasive products for steel, and a wooden or plastic tool if necessary.

Rinse thoroughly and dry with a soft cloth or deerskin.

Do not allow residues of sugary foods (such as jam) to set inside the oven. If left to set for too long, they might damage the enamel lining of the oven.





7.2 Cleaning of the oven (without self-cleaning panels)



For best oven upkeep clean regularly after having allowed to cool. Take out all removable parts.



- **DO NOT USE A STEAM JET FOR CLEANING THE INSIDE OF THE OVEN.**
- Clean the oven grill and side guides with hot water and non-abrasive detergent. Rinse and dry.
- The oven should be operated at the maximum temperature for about 15/20 minutes after using specific products, to eliminate the residues deposited inside the oven.
- For easier cleaning, the door can be removed (see P. 8.2)



Instructions for the user

7.2.1 Self-cleaning liners (only on some models)

The oven is equipped with continuous self-cleaning enamelled liners.

These liners make the oven easier to clean and ensure its efficiency over time.

7.2.2 Using the self-cleaning liners

Periodically, to prevent food residues and unpleasant smells from accumulating inside the oven, the appliance should be operated empty at temperatures of not less than 200°C for a time varying from 30 to 60 minutes, in order to allow the self-cleaning liners to oxidise the residues present; when the oven has cooled, these will then be removed with a damp sponge

7.2.3 Looking after the self-cleaning liners

The liners should not be cleaned with abrasive creams or ordinary detergents. Use a damp sponge only, so as not to damage the special characteristics of the enamel which coats the liners.

7.2.4 Assembling the self-cleaning liners

1. Remove all accessories from the oven;
2. Remove the side grilles (fig.1);
3. Extract the side liners "F" and "G"(fig. 2);
4. Remove the back panel "A" after undoing the threaded ring-nut "C" (fig. 2).
5. Reassemble the panels, restoring them to their original position.

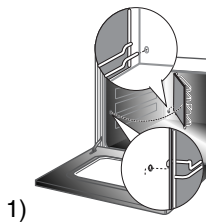

1)

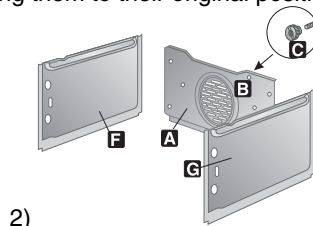

2)

7.3 Door glass

The door glass should always be kept clean. Use absorbent kitchen paper to clean. In case of tough spots, clean with a damp sponge using regular detergent.



8. EXTRAORDINARY MAINTENANCE

The oven may require extraordinary maintenance or replacement of parts subject to wear such as seals, bulbs, and so on. The following instructions describe how to carry out these minor maintenance operations.



Before any intervention, disconnect the power supply of the device.

8.1 Replacement of light bulb

Remove the bulb protector **A** by turning anticlockwise and change bulb **B** (in the 8-function model with front glass panel change the halogen bulb **C**) with a similar one. Re-fit the bulb protector **A**.

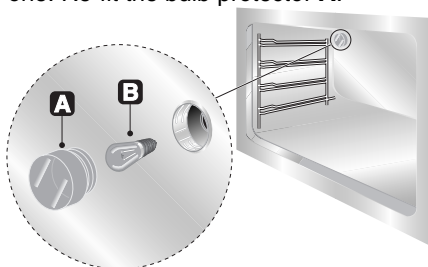

Only use oven bulbs (T 300°C).



Instructions for the user

8.2 Removing

Hold the door on both sides with both hands near hinges **A** and raise levers **B**. Lift up the door forming an angle of about 45° and remove. To refit, slide the hinges **A** in the grooves, drop the door and release levers **B**.

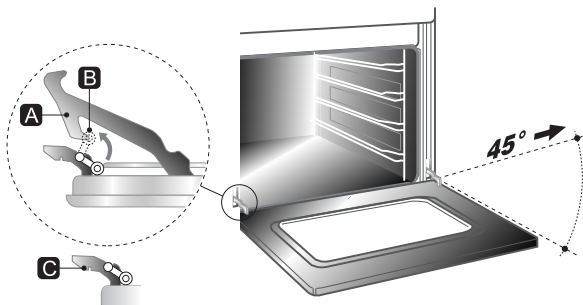

8.3 Oven door seal

To permit thorough cleaning of the oven, the seal may be removed. Before removing the seal, take off the door as described above. Once the door has been taken off, lift the tabs at the corners as shown in the figure.

After cleaning, refit the seal with the longer side horizontal and insert the tabs into the appropriate holes starting from the top ones.

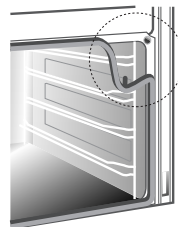



914772118/ D