

Miele

Operating and Installation Instructions

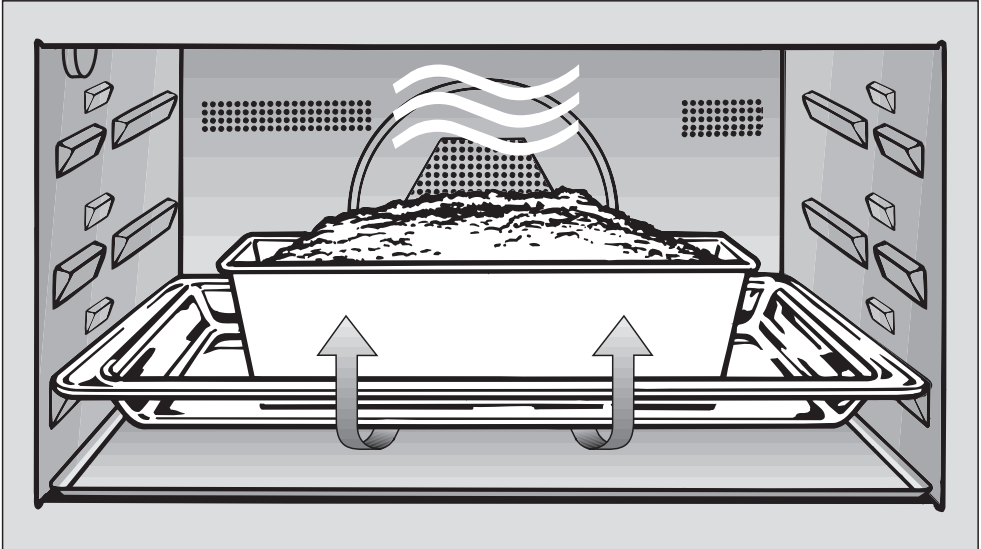

Convection microwave oven H 4044 BM



To prevent accidents
and machine damage
read these instructions

before
installation or use.

en - US, CA

M.-Nr. 07 979 370

Contents

| | |
|-------------------------------------------------------------------------------------------------------------------|----|
| IMPORTANT SAFETY INSTRUCTIONS | 4 |
| Guide to the oven | 10 |
| Guide to the display | 11 |
| Function selector | 11 |
| Temperature selector | 11 |
| Touch controls | 12 |
| Display | 12 |
| Oven accessories | 14 |
| Safety and energy saving features | 16 |
| Settings  | 18 |
| Selecting cookware | 20 |
| Before using the oven | 24 |
| Enter time of day | 24 |
| Cleaning the appliance | 25 |
| Heating the oven | 25 |
| Using the oven | 26 |
| Microwave | 26 |
| Combi functions | 27 |
| Solo functions | 28 |
| Temperature indicator  | 28 |
| Rapid Heat | 28 |
| End of a cooking process | 29 |
| Selecting cooking times | 30 |
| Automatic shut-off | 30 |
| Delay start with automatic shut-off | 31 |
| Timer | 33 |
| Setting the timer | 33 |
| Canceling the timer | 33 |

| | |
|---------------------------------------------|----|
| Functions | 34 |
| Solo functions | 34 |
| Combi functions | 34 |
| Microwave | 35 |
| Baking | 36 |
| Convection bake | 36 |
| Combination bake | 36 |
| Broiling | 37 |
| Convection broil | 37 |
| Combination broil | 37 |
| Maxi Broil | 38 |
| Micro Broil | 38 |
| Defrost | 39 |
| Defrost / Heat and Cook | 40 |
| Cleaning and Care | 41 |
| Interior | 41 |
| Inside of door with door seal | 43 |
| Front of appliance | 43 |
| Accessories | 44 |
| Frequently asked questions | 45 |
| Changing the light bulb | 47 |
| Technical Service | 48 |
| Installation instructions | 49 |
| Electrical connection | 50 |
| Installation | 51 |
| Appliance front dimensions | 54 |
| Installation | 55 |

IMPORTANT SAFETY INSTRUCTIONS

When using electrical appliances always observe basic safety precautions, including the following:

WARNING - To reduce the risk of burns, electric shock, fire, injury to persons, or exposure to excessive microwave energy:

Read all instructions before installing or using the oven.

Read and follow the specific, "PRECAUTIONS TO AVOID POSSIBLE EXPOSURE TO EXCESSIVE MICROWAVE ENERGY".

This appliance is intended for residential use only. Only use the appliance for its intended purpose.

This appliance complies with current safety requirements. Improper use of the appliance can lead to personal injury and material damage.

Keep these operating instructions in a safe place and pass them on to any future user.

SAVE THESE INSTRUCTIONS

Use

► The appliance is intended for domestic use only: defrosting, heating, cooking, baking, roasting and broiling of food.

It is not designed for industrial or laboratory use.

► Do not use the appliance to store or dehydrate flammable materials. This is a fire hazard.

► Persons who lack physical, sensory or mental abilities, or experience with the appliance should not use it without supervision or instruction by a responsible person.

Children

► Children should not be left unattended in an area where the appliance is in use. Never allow children to hang or lean on any part of the appliance.

► Children should not use the unit without supervision unless its operation has been sufficiently explained so that they can run it safely. Children must be able to recognize potential hazards or improper operation.

► Do not allow children to touch or play in, on or near the oven when it is in operation. The oven gets hot at the oven door glass, the vapor vent, the handle and the operating controls. Danger of burns.

IMPORTANT SAFETY INSTRUCTIONS

Technical Safety

- ▶ Installation, repair and maintenance work should be performed by a Miele authorized service technician in accordance with national and local safety regulations and the provided installation instructions. Contact Miele's Technical Service Department for examination, repair or adjustment. Repairs and other work by unauthorized persons could be dangerous and may void the warranty.
- ▶ Before installation, make sure that the voltage and frequency listed on the data plate correspond with the household electrical supply. This data must correspond to prevent injury and appliance damage. Consult a qualified electrician if in doubt.
- ▶ To guarantee the electrical safety of this appliance, continuity must exist between the appliance and an effective grounding system. It is imperative that this basic safety requirement be met. If there is any doubt, have the electrical system of the house checked by a qualified electrician.
- ▶ Before installing the oven, check for externally visible damage. **Do not** operate a damaged appliance.
- ▶ This appliance must not be installed or operated outdoors.
- ▶ Do not install this appliance near water, e.g. sink, wet basement, swimming pool, etc.
- ▶ Do not use an extension cord to connect this appliance to electricity. Extension cords do not guarantee the required safety of the appliance.
- ▶ The appliance must only be operated after it has been correctly installed into cabinetry.
- ▶ Under no circumstances open the outer casing of the appliance.
- ▶ While the appliance is under warranty repairs should only be performed by an authorized service technician. Otherwise the warranty is void.
- ▶ Before servicing, disconnect the appliance from the main power supply.
- ▶ Defective components should be replaced by Miele original spare parts only. Only with these parts can the manufacturer guarantee the safety of the appliance.
- ▶ Do not operate any appliance with a damaged cord or plug, or if the appliance has been damaged in any manner. Contact Miele's Technical Service Department.
- ▶ This appliance is not designed for maritime use or for use in mobile installations such as recreational vehicles or aircraft. However, under certain conditions it may be possible for installation in these applications. Please contact the Miele Technical Service Department with specific requirements.

IMPORTANT SAFETY INSTRUCTIONS

Safety

- ▶ Do not use corrosive chemicals or vapors in this appliance.
- ▶ Do not use the oven to heat the room. Due to the high temperatures radiated, objects left near the oven could catch fire.
- ▶ Times for cooking, heating and defrosting food in the convection microwave oven are shorter than that of traditional food preparation methods. Extensive microwaving could dry out food and cause possible ignition. This is a fire hazard
- ▶ Do not use the microwave function to dry bread, flowers, herbs, etc. Use the Convection Bake function.
- ▶ Do not heat cushions filled with herbs, gel, etc. with the microwave function. The cushions could ignite, even once removed from the oven after heating. This is a fire hazard.
- ▶ Do not use full power when warming empty dishes or drying herbs. The lack or minimal amount of food could cause damage to the appliance.
- ▶ Do not use for cleaning and disinfecting utensils and cookware. There is a risk of burns from the high temperatures from the utensil when it is taken out of the oven. This is a fire hazard.
- ▶ Supervise cooking with grease or oils. Oils and grease could ignite.
- ▶ Never heat undiluted alcohol in the microwave oven, it can easily ignite.
- ▶ If materials inside the oven ignite, keep the oven door closed to avoid fueling any flames. Turn the function selector to "Off" and disconnect the power supply.
- ▶ If smoke occurs in the oven, to avoid fueling any flame, do not open the oven door. Turn the function selector to "Off" and disconnect the power supply. Do not open the oven door until the smoke has dispersed.
- ▶ To avoid corrosion damage from condensation:
 - Cover meals when cooking with the Microwave Solo function.
 - When using residual heat to keep food warm leave the selected function on and select the lowest temperature. Do not turn the oven off. Condensation from food and drinks could cause damage at the machine or the countertop and cabinetry. Leaving the machine on will keep the fan running to aid in dissipating the condensation.
 - Cover food stored in the oven interior. Condensation from food and drinks could cause corrosion damage. It also prevents the food from drying out.

IMPORTANT SAFETY INSTRUCTIONS

- ▶ Only use accessories approved by Miele for use with this machine. Use of other accessories may cause damage and void the warranty.
- ▶ Do not lean, sit or place heavy items on the open oven door. The machine may be damaged. The door can hold a max. of 17.5 lbs (8 kg).
- ▶ Do not cover or block any opening on the appliance.

Microwave function

PRECAUTIONS TO AVOID POSSIBLE EXPOSURE TO EXCESSIVE MICROWAVE ENERGY

Do not attempt to operate this oven with the door open since open-door operation can result in harmful exposure to microwave energy. It is important not to damage or tamper with the safety interlocks.

Do not place any object between the oven front and the door or allow soil or cleaner residue to accumulate on sealing surfaces.

Do not operate the oven if it is damaged. It is particularly important that the oven door closes properly and that there is no damage to the: (1) door (bent), (2) hinges and latches (broken or loosened), (3) door seals and sealing surfaces.

The oven should not be adjusted or repaired by anyone except properly qualified service personnel.

- ▶ Do not operate the convection microwave oven empty! The oven will be damaged.
- ▶ Be sure to use cookware suitable for the function being used. See "Selecting cookware".
The provided combi rack is specially designed for use in this oven.

IMPORTANT SAFETY INSTRUCTIONS

▶ Do not leave the appliance unattended when heating food in disposable, e.g. plastic, paper or other flammable materials.
See "Selecting cookware".

▶ Do not use the oven to heat food in heat retaining packaging, e.g. take-out food bags.

This packaging contains a thin layer of aluminum foil which reflects the microwaves. This reflected energy can cause the paper layer to ignite.

▶ Before serving food allow a sufficient standing time. Always check the temperature of the food itself after taking it out of the microwave oven. Do not judge by the plate temperature. The heat is created in the food, the dishes may stay cool to the touch.

▶ Always check the temperature before serving heated baby food.

▶ Use a food thermometer to measure the food's temperature. Do not use thermometers containing mercury or liquids, they are not suitable for high temperatures and break easily.

▶ Always check that food is sufficiently heated. The time required varies depending on a number of factors, such as initial temperature, quantity, type and consistency of the food, and changes in the recipe. Germs present in the food are killed off only at a sufficiently high temperature (> 158°F / 70°C) and after a sufficiently long time (> 10 Min.). Select a longer cook time if you are unsure if food is thoroughly heated. To ensure temperature is distributed evenly, stir and rotate food occasionally time before serving.

▶ Never cook or reheat food and liquids in sealed containers or bottles. Remove the nipple or lid before heating in the microwave oven. Built-up pressure may cause them to burst. Danger of injuries.

▶ When heating liquids, the provided boiling wand should be placed into the container.

When heating liquids, milk, sauces, etc., in the oven without the boiling wand, the boiling point of the liquid may be reached without the production of bubbles. The liquid will not boil evenly. This "boiling delay" can cause a sudden build up of steam bubbles, when the container is removed from the oven or shaken. This can lead to the liquid boiling over suddenly and explosively. Danger of burning!

The built-up pressure may force the oven door open. This could result in injury or damage. The boiling wand ensures that the liquid boils evenly and that steam bubbles form at an early stage.

IMPORTANT SAFETY INSTRUCTIONS

▶ Eggs must only be cooked in their shells in the microwave oven in a specially designed egg-boiling device. Hard-boiled eggs should not be reheated in the microwave oven. The eggs may burst, even once they have been removed from the oven.

▶ Eggs can be cooked without their shells in the microwave oven only if the yolk membrane has been punctured first. The pressure could otherwise cause the egg yolk to explode. Danger of injuries.

▶ Food with a thick skin or peel, such as tomatoes, sausages and potatoes should be pierced in several places before cooking to allow steam to vent and prevent the food from bursting.

▶ Do not use dishware with hollow handles or lid knobs. Moisture can get into the hollow parts. (The hollow parts of some dishware can be vented). Danger of built-up pressure and the explosion of the hollow parts may cause injuries.

Solo functions:

Rapid Heat, Convection Bake, Maxi Broil, Convection Broil

Caution! Danger of burns!
When using solo functions the oven interior gets very hot.

▶ Be sure to use cookware suitable for the function being used. See "Selecting cookware".

▶ Use pot holders when working with a hot appliance. Especially the upper heating element gets extremely hot when using any broil function. Danger of burning!

**SAVE THESE INSTRUCTIONS
AND REVIEW THEM
PERIODICALLY**

Guide to the oven

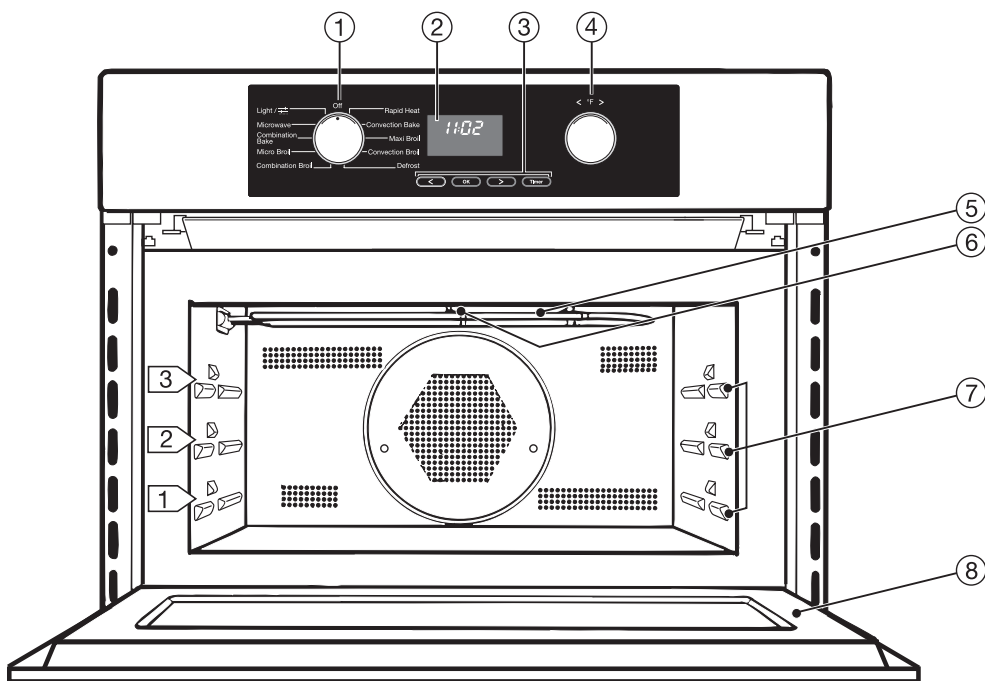

- ① Function selector
- ② Display
- ③ Touch controls <, OK, >, Timer
- ④ Temperature selector
- ⑤ Heating element
- ⑥ Light
- ⑦ Three level runners
- ⑧ Oven door



Function selector

The left-hand selector is used to select the function.

It can be turned clockwise or counter clockwise.

- Microwave
- Combination Bake
- Micro Broil
- Combination Broil
- Rapid Heat
- Convection Bake
- Maxi Broil
- Convection Broil
- Defrost
- Light
For switching on the oven light independently. This can be useful when cleaning the oven.
- Settings
For altering the settings of the appliance.

Temperature selector

The right-hand selector < °F > is used to

- select the temperature.
- enter times (as an alternative to using the < or > touch controls).

It can be turned clockwise to increase the value or counter clockwise to reduce the value.

The temperature can be displayed in °F or °C, see "Settings - P 7".

Guide to the display

Touch controls





The microwave oven is operated by electronic sensor controls which react to the touch of a finger. Every touch of the controls is confirmed by a tone.

The tone can be turned off.

See "Settings  - P 4"

| | Use |
|-------|---------------------------------------------------------------------------------------------------------------------------------------------------------------------------------------------------|
| OK | <ul style="list-style-type: none">- For selecting an entry. A triangle ▲ appears under the selected symbol.- To confirm an entry. |
| < | <ul style="list-style-type: none">- Moves triangle ▲ in the display to the left or right. |
| > | <ul style="list-style-type: none">- Increases or reduces the microwave power setting / time entered.- For selecting the Setting <i>P</i> and changing the Status <i>5</i>. |
| Timer | To enter a short cooking time, such as for eggs. |

Each time < or > is pressed, the following changes are made:









- Time  Microwave (Solo) in 10-second increments,
- Time  in 1-minute increments,
- End  in 1-minute increments,
- Short time  in 5-second increments, followed by 1-minute increments.

Press and hold the touch controls to quickly move through the display.

Display



Depending on the position of the function selector and/or pressing of a touch control, the following symbols appear:

-  Microwave power output
-  Temperature
-  Time
-  Duration
-  End
-  Safety lock
- Start** Start microwave
-  Temperature indicator
-  Set timer
- h** Hours
- min** Minutes

Triangle ▲ in the display

When the triangle lights up ▲ below a symbol in the display, the corresponding function is indicated.

If the triangle flashes ▲ below a symbol, the function has been selected and can be changed.

The triangle ▲ flashes for about 15 seconds.
The setting can be changed using < or > only while it is flashing.
If this entry time elapses, you must once again call up the desired symbol with "OK".



When one of the touch controls is pressed, depending on the position of the function selector, the **symbols of the settings** that can be entered light up in the display.

- Press < or > until the triangle ▲ stops underneath the desired symbol.
- Select "OK" to confirm.
The **triangle ▲** flashes.

Oven accessories

Boiling wand



When heating liquids, the provided boiling wand should be placed into the container. It results in even boiling of the liquid.

Glass tray with non-tip safety notches

This tray is suitable for all microwave oven functions.

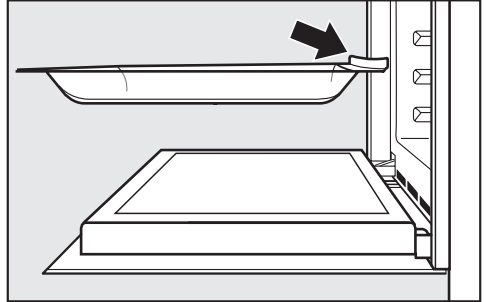

Always use the glass tray when using the Microwave (Solo) function.

When inserted the safety notches should face the rear.

The glass tray can hold a max. of 17.5 lbs (8 kg).

Never place the hot glass tray directly on a cold surface, such as a tiled or granite countertop. The glass tray may crack.

The tray has non-tip safety notches which prevents it from being pulled out completely.

The glass tray must be lifted to be taken out of the oven.

Combi rack

The combi rack is specially designed for microwaves and can be used with programs that use microwave power (combi programs).

It should not be set on the bottom of the oven and do not use it with the Microwave (Solo) function. This could cause arcing which could damage the oven.

The combi rack can hold a max. of 17.5 lbs (8 kg).

The combi rack becomes very hot during use. Use caution.

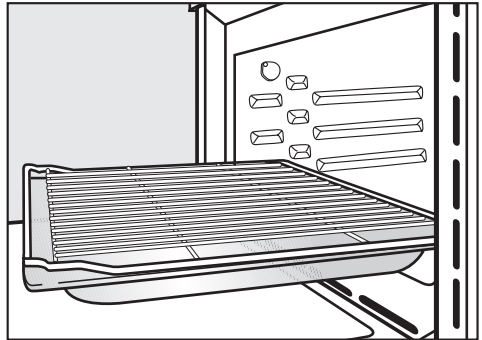
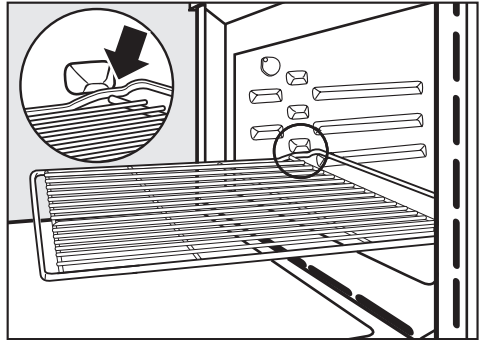

When inserting a rack, always check that the safety notches are at the rear of the oven.

The rack can only be removed by raising it upwards and then pulling out.

During certain functions, it is recommended to use the combi rack along with the glass tray.

Safety and energy saving features

System lock

The oven can be locked  to prevent unauthorized use.

- Turn the function selector to "Off".

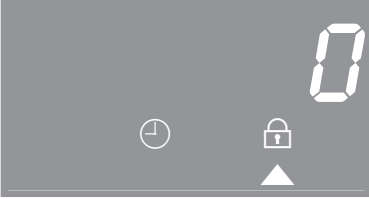

- Continue pressing > until ▲ is below the  symbol.
- Press "OK".



- As long as the triangle ▲ below the  symbol is flashing, you can use < or > to toggle between "I" and "0".
 - "0" The system lock is deactivated.
 - "I" The system lock is activated.
- Select "OK" to confirm the setting.

The symbol  acts as a reminder that the lock is activated.

The oven will remain locked after a power failure.

Automatic Safety Shut-off

A function without Microwave can be started without a duration set. To prevent a run-on operation and a fire hazard the oven shuts off automatically. Depending on the temperature and function selected, the oven will turn off 1 to 10 hours after the last operation was selected.

When the microwave is turned off after one operation but will be used for a second cooking function right away, you must wait 10 seconds before the power can be turned on again.

Door contact switch

If the door is opened during a **function without microwave**, the heat will automatically turn off but the fans will remain on. The function will continue again once the door is closed.

If the door is opened during a **function with microwave**, the heat and fan will both turn off automatically. After closing the door, the operation must be restarted.

Switching off time display

The display darkens when the function selector is in "Off" position. The time will continue to run in the background (see "Settings  – Time display").

Settings

The default oven settings can be changed in the function "Settings ". In this function you can customize the oven to suit your preferences.

| Setting | Status (* Factory setting) | |
|-------------------------------------------|------------------------------------------------------------|----------------------------------------------------------------------------------------------------------------------------------------------------------------------------------------------------------------------------------------------------------------------------------------------------|
| <i>P 1</i> Time display | <i>5 0</i> <i>5 1*</i> | The time display is turned off . The display is dark when the function selector is in the "Off" position. The time runs in the background. The time display is turned on and visible. |
| <i>P 2</i> Duration signal tone | <i>5 0</i> <i>5 1*</i> (long) <i>5 2</i> (short) | When a set duration time expires, no signal sounds . When a set duration time expires, a signal sounds . You can choose between two signal sounds. |
| <i>P 3</i> Timer signal tone | <i>5 0</i> <i>5 1*</i> (long) <i>5 2</i> (short) | When the timed period ends, no signal sounds . When the timed period ends, a signal sounds . You can choose between two signal sounds. |
| <i>P 4</i> Key tone | <i>5 0</i> <i>5 1*</i> | The key tone is turned off . The key tone is turned on . |
| <i>P 5</i> Volume signal tones | <i>5 0* – 5 30</i> | If the settings " <i>P 2 – 5 2</i> " and " <i>P 3 – 5 2</i> " are selected the volume of the short signal tones can be adjusted using <i>5 0* – 5 30</i> . If the settings " <i>P 2 – 5 1</i> " and " <i>P 3 – 5 1</i> " are selected the volume of the long signal tone cannot be changed. |
| <i>P 6</i> Time format | <i>12*</i> <i>24</i> | The current time appears as a 12 hour display . The current time appears as a 24 hour display . |
| <i>P 7</i> Temperature unit | <i>°F*</i> <i>°C</i> | Temperature is displayed in °F . Temperature is displayed in °C . |

Changing the status of a setting

- Turn the function selector to Light / .
- Select "OK".



"P 1" appears in the display.

The settings "P 1" to "P 7" can be changed individually.

- Press < or > until the desired setting number appears in the display.
- Select "OK".



The current status of the setting "5" (example) appears in the display.

- Use < or > to change the setting status (see table).
- Select "OK".

The status change is stored in memory.

"P" and the number of the setting appear again in the display.

Other settings can also be changed at this time as long as the function selector is not turned to "Off".

The settings will remain saved in the case of a power failure.

Selecting cookware

Microwaves:

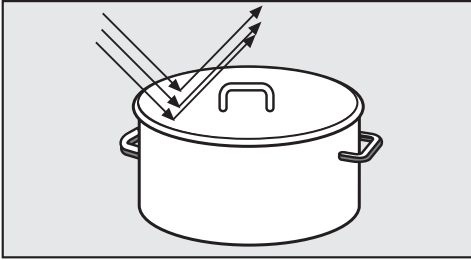

– are reflected by metal,

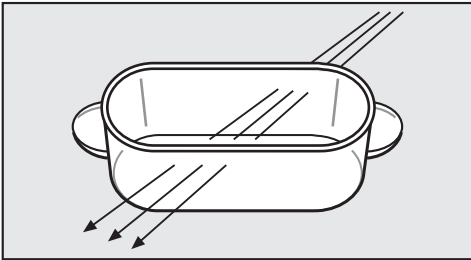

– pass through glass and chinaware,

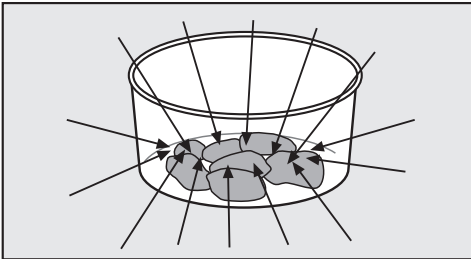

– are absorbed by the food.

Material and shape

The material and shape of containers used affect cooking results and times. Circular and oval containers work best. The food will heat more evenly than in a square container.

⚠ Containers and lids which contain hollow handles or knobs are not suitable for use in the oven. The handles or knobs could collect moisture if not adequately vented. Without vent holes pressure can build up, causing the container to crack or shatter. Danger of injury.

Metal

⚠ Do not use metal containers, aluminum foil, cutlery or dishes with metal decor during the microwave-solo function. Metal reflects the microwaves which hinders the cooking process. Sparks may occur.

Do not use plastic cups with incompletely removed aluminum lids (such as cream cups). The remnants of the lids can lead to sparking.

Selecting cookware

Exceptions:

The enclosed combi rack is only suitable for combi functions not the microwave solo function. Do not set it on the oven floor.

- Metal baking dishes are suitable for baking with a combination microwave baking method. However they are not recommended, metal reflects the microwaves causing longer cooking times. In addition, the use of metal pans could cause sparking.
- Pre-cooked meals in aluminum foil containers can be defrosted and reheated in the oven. **Important:** Remove the lid before heating the food.
The food is heated only from above. To heat the food evenly place it in a container suitable for microwaving.

When using aluminum foil containers, crackling and sparking may occur, do not place them on the combi rack.

- For even defrosting and to avoid overcooking unevenly shaped cuts of meat, poultry or fish, small pieces of aluminum foil may be used to mask wing-tips or other thin parts for the last few minutes of the process.

Make sure that the aluminum foil is at least 1 inch (2.5 cm) from the oven walls at all times. It **must not** touch the walls.

- Metal meat skewers or clamps should only be used if they are small in comparison to the size of the meat.

Glassware

Heat-resistant glass or ceramic glassware are ideal for use in the oven.

Crystal contains lead and is unsuitable.

Porcelain (china)

Porcelain (china) is suitable for use in the oven.

Do not use porcelain with gold or silver edging or items with hollow knobs or handles, insufficient ventilation may cause damage.

Earthenware

Decorated earthenware is only suitable if the decoration is beneath the glaze.

Earthenware can get very hot and may crack.

Glazes and colors

Some glazes and colors contain metallic substances. They are not suitable for the oven.

Wood

Wood containers are not suitable. The water from the wood evaporates during the cooking process causing it to dry out and crack.

Selecting cookware

Plastics

Use plastic dishes **only** for Microwave - Solo. They must be heat resistant up to 230°F (110°C) otherwise the plastic may melt into the food.

Special plasticware, designed for use in microwave ovens is available in retail outlets.

Plastic boiling bags can be used for cooking and reheating. They should be pierced beforehand so that steam can escape. This prevents a build-up of pressure and reduces the risk of the bag bursting.

Disposable containers

Only those plastic disposable containers specified under "Plastics" are suitable for use in the oven.

Do not leave the oven unattended when reheating or cooking food in disposable containers made of plastic, paper or other flammable materials.

Disposable containers are not always microwave safe.

Roasting bags

These bags can be used in the oven. Please follow the manufacturers' instructions.

 Do not use metal clips, plastic clips with metal parts, or twist ties containing wire. They could ignite when heated.

Covering the food

Use a cover only during the Microwave function. Plastics are only heat-resistant up to 230°F (110°C). Higher temperatures (Broiling, Convection Bake, etc.) can cause the cover to melt into the food.

The cover should not completely seal the container. This may prevent steam from escaping causing the cover to melt.

A cover:

- prevents most of the steam from escaping, especially when cooking foods which need longer to cook, such as potatoes.
- shortens and evens out the cooking process.
- prevents the food from drying out.
- prevents soiling of the oven interior.

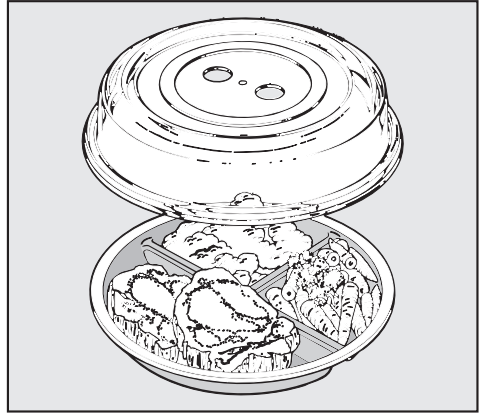

- Cover the food with a glass or plastic lid suitable for ovens. They are available in retail stores. Plastic wrap suitable for microwaving can also be used.



 Do not heat food in closed containers e.g. glass baby food containers. Vent the container before heating.

Do not use a lid or cover if cooking food in which a crisp finish is desired e.g. breaded chicken, garlic bread, etc.

Before using the oven

Enter time of day

- Turn the function selector to "Off".

The symbol  lights, the time flashes and the triangle  below the symbol .

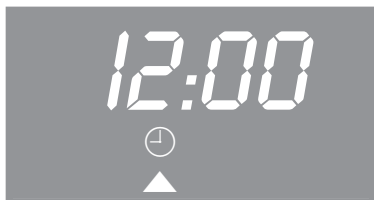

- Use the temperature selector or the < or > touch controls to enter the hour.
- Select "OK" to confirm the selection.
- Use the temperature selector or the < or > touch controls to enter the minutes.
- Select "OK".

The time setting is confirmed.

If the power is cut off for more than 24 hours the clock will have to be reset.

Change time of day

- Press the "OK" touch control twice.
- Use the temperature selector or the < or > touch controls to enter the hour.
- Select "OK" to confirm the selection.
- Use the temperature selector or the < or > touch controls to enter the minutes.
- Select "OK".

The time has been changed and saved into memory.

Cleaning the appliance

Remove the protective film from the appliance front (if present).

- Wipe the interior with a solution of warm water and liquid dish soap. Dry with a soft cloth.

Leave the door open until the interior is completely dry. Otherwise odors and corrosion may occur.

- Wash the accessories.

See "Cleaning and care" for more information.

Heating the oven

New ovens may have a slight odor during the first use. To eliminate the odor quickly, the oven should be operated at a high temperature for at least 1 hour.

Before heating the oven, remove all accessories and labels.

Make sure the room is well ventilated during this process.

- Turn the function selector to "Convection Bake".

The factory-suggested temperature of 325°F (160°C) is indicated.

- Using the temperature selector, set the maximum temperature, 475°F (250°C).
- Heat the empty unit for at least one hour.

To automatically end this procedure; see "Selecting cooking times".

- Allow the appliance to cool to room temperature.
- Clean the oven with warm water and a mild cleaning agent and dry it with a clean cloth.

Close the door when the oven interior is completely dry.

Using the oven

For a description of each function see the "Functions" section of these operating instructions.

Microwave

- Turn the function selector to Microwave.

The oven specifies the "Default" power level.



- To select a lower power level, while the triangle ▲ is flashing, use < to change the setting.
- Confirm the setting by pressing "OK", or simply wait a few seconds. The following appears in the display:

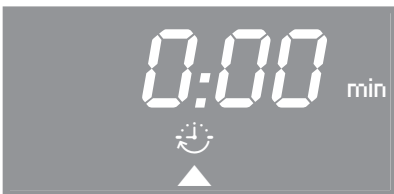

- While the triangle ▲ is flashing, use the temperature selector or the > touch control to enter the desired duration in minutes:seconds (e.g., 1:30 minutes).

- Confirm the setting by pressing "OK", or simply wait a few seconds. The following appears in the display:

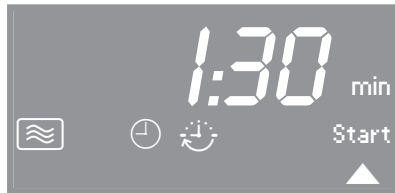

- Select "OK" to start the function.

The countdown of the duration will be in the display.

As soon as the function is interrupted or the door is opened the microwave function will stop.

At the end of the microwave function:

- the 🌀 symbol flashes.
- the cooling fan continues to run.
- if the signal tone is turned on, a signal tone is heard (see "Settings 🗄️"). Press any touch control to interrupt the tone.
- The current time appears in the display.
- The oven lighting shuts off.

Combi functions

Combination Bake, Combination Broil, Micro Broil

- Select the desired function.

The oven specifies a "Default" power level, "HI". You may also select a lower power level, "LO".

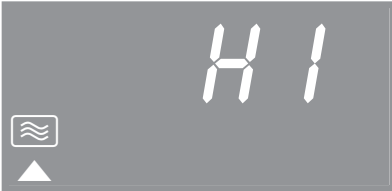

- To select a lower power level, while the triangle ▲ is flashing, use < to change the setting.
- Confirm the setting by pressing "OK", or simply wait a few seconds. The following appears in the display:



- While the triangle ▲ is flashing, use the temperature selector or the < or > touch controls to enter the desired duration in minutes:seconds (e.g., 1:30 minutes).

Depending on the power level selected, you can enter a time of up to 2 hours.

Confirm the setting by pressing "OK", or simply wait a few seconds.

The following appears in the display:

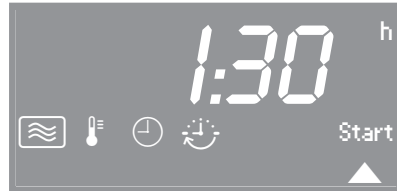

If the desired temperature does not correspond to the default temperature:

- Use the temperature selector to set the desired temperature (except with the Micro Broil function).

The following appears in the display:

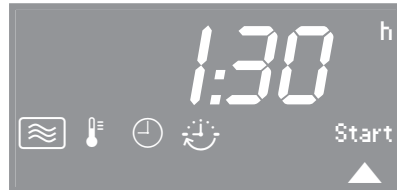

- Select "OK" to start the function.

The countdown of the duration will be in the display.

At the end of the combi function:

- the oven heating automatically turns off.
- the cooling fan continues to run.
- the 🕒 symbol flashes.
- if the signal tone is switched on, a signal will sound (see "Settings 🗄️").
- Turn the function selector to "0". All signals turn off.

Using the oven



Solo functions

Functions without microwave

- Place food in the oven.
- Select the desired function (e.g., Convection Bake).

The display will show:



- the default temperature "325",
- Temperature indicator ,
- the triangle  below the  symbol.

The heating, lighting and cooling fan turn on simultaneously.

Once the selected temperature is reached, the temperature indicator goes out and a signal sounds.

- After the cooking process, turn the function selector to "Off" and remove the food from the oven.

Cooling fan



The cooling fan will continue running for some time so that moisture cannot condense in or around the oven.

It will turn off automatically once the oven has cooled down to a factory set temperature.

Temperature indicator

In addition to the temperature, the **Temperature indicator**  also appears in the display. It will always light when the oven heating is turned on.

When the selected temperature is reached,

- the oven temperature goes out.
- the temperature indicator  goes out.
- if the signal tone is turned on, a signal sounds (see "Settings ").

Should the temperature fall below the value set, the oven heating and temperature indicator will turn on again.

Rapid Heat

Default temperature 325°F (160°C)

Rapid Heat can be used to pre-heat the oven.



- Select "Rapid Heat".
- Set the required temperature using the temperature selector.

Oven heating begins.

- After the temperature indicator  goes out and the signal sounds, select the desired function and place the food in the oven.

End of a cooking process

After the Duration elapses:

- the oven heating automatically turns off.
- the cooling fan remains running after a function with microwave.
- the  symbol flashes.
- if the signal tone is turned on, a signal sounds (see "Settings ").
- Turn the function selector to "0".

Tips:

- Most foods can be placed directly in the cold oven, so heat used during the heating phase can be used to begin cooking.
- To avoid too-rapid browning, do not use Rapid Heat for pizza and/or sensitive doughs like biscuit or cookie.
- Not suitable for most baking processes, i.e. batters may dry out, yeast will deactivate, etc.

Selecting cooking times

The oven can be programmed to turn on and off automatically.

Duration

Enter the time required for the process. When this time has elapsed, the oven automatically shuts off.



The maximum duration that can be set depends on the function / power level selected.

When using a function with microwave, a duration must always be set.

End time

With this function you can set the oven to turn off automatically.

Automatic shut-off

To have a cooking function automatically turn off, enter a Duration  or End time .

Example: Enter "Duration"

- Place food in the oven.
- Select a function and temperature.

The heating, lighting and cooling fan turn on simultaneously.



- Continue pressing > until the triangle ▲ is below  (Duration).

"0:00" appears in the display.

- Select "OK".
- While the triangle ▲ is flashing, enter the duration in hours:minutes using the temperature selector or the > touch control.
- Select "OK" to confirm the setting (or simply wait a short time).

The countdown of the duration will appear in the display.

Delay start with automatic shut-off

To have a cooking process automatically turn off, enter a Duration

🕒 or End time 🕒.

Example:

The current time is 10:45 a.m.; a roast with a duration of 90 min. needs to be ready around 1:30 p.m.

- Place the food in the oven.
- Select a function and temperature.

The heating, lighting and cooling fan turn on simultaneously.

- Enter the **Duration**:



- Continue pressing > until the triangle ▲ is below 🕒 (Duration).

"0:00" appears in the display.

- Select "OK".



- While the triangle ▲ is flashing, enter the duration in hours:minutes (1:30) using the temperature selector or the > touch control.
- Select "OK".

Now **change the End time**:



- Press > until the triangle ▲ is below 🕒 (End).

The display shows the current time plus the Duration entered (10:45 + 1:30 = 12:15 p.m.).

- Select "OK".

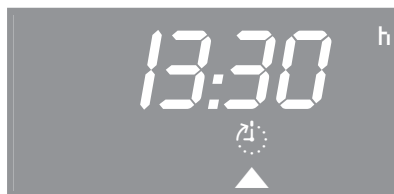

- While the triangle ▲ is flashing, move the end time using the temperature selector or the > touch control to the desired time (1:30 p.m.).
- Select "OK" to confirm the setting (or simply wait a short time).

Oven heating, lighting and cooling fan turn off.

End time is in the display, as long as the triangle is not moved under another symbol.

As soon as the start time (1:30 p.m. - 1:30 = 12:00 p.m.) is reached, the oven heating, lighting and cooling fan will turn on.

Selecting cooking times

Verify and/or change times entered

You can verify or change the times entered for a process at any time by selecting the relevant symbol with < or >.

To change

- Select OK and, while the triangle ▲ is flashing, change the setting with the temperature selector or the < or > touch controls.

Delete times entered

- Turn the function selector to "0".

The timer can be used to time any activity in the kitchen and can be set independently of a cooking function.

The timer can be set from 5 seconds to 99 minutes 55 seconds.

Setting the timer

- Select "Timer".





- While  is flashing, enter the time using the temperature selector or the > touch control.

With each press the time changes, first in 5 second increments, followed by 1-minute increments.

- Select "OK" to confirm the setting (or simply wait a short time).

The timer display will count down in one-second-increments.

At the end of the timed period:

- the symbol  will flash.
- if the signal tone is turned on, a signal will sound (see "Settings ").
- the time that had passed since the time set had expired appears in the display.

- Select "OK".

Canceling the timer

- Select "Timer".
- If desired, while  remains flashing reset the timer to "0:00" using the temperature selector or the < touch control.
- Select "OK" to confirm the setting (or simply wait a short time).

Functions

Solo functions

– Microwave

To defrost, reheat and cook in a microwave oven is quicker than using traditional oven methods.

– Rapid Heat

The oven is pre-heated to the desired temperature as rapidly as possible. Once the temperature has been reached the temperature light goes out and a signal sounds. The function selector must then be turned to the desired function.

– Convection Bake

A stream of hot air is generated and then fanned throughout the interior for even cooking.

Two runner can be cooked on simultaneously.

– Maxi Broil

This operating mode is ideal for grilling flat food items and for browning casseroles or similar dishes.

– Convection Broil

Lower temperatures as used than for "Maxi Broil".

This mode is used for grilling food items of greater diameter, such as rolled meats and poultry.

– Defrost

This function enables frozen food and baked goods to be gently thawed, by circulating oven air by fans at room temperature.

Combi functions

– Micro Broil

– Combination Bake

– Combination Broil

For a combination of the microwave function with a solo function. These functions allow for fast heating, cooking and browning of food.

Do not cover the food in combi functions. The food will not get a crisp finish.

Convection Bake is usually the most suitable. Since the heat immediately gets to the food, the time and energy efficiency is greatest.

Do Not Operate the Microwave Oven empty! The oven will get damaged.

Microwave cooking offers speed, convenience and nutritional benefits when food does not require browning or crisping.

The moisture content of food will affect the speed at which it is cooked.

Heat is produced directly in the food, therefore:

- food can generally be cooked without adding much liquid or cooking oil.
- defrosting, reheating and cooking in a convection microwave oven is quicker than using traditional oven methods.
- nutrients, such as vitamins and minerals, are generally retained.
- color, texture and taste of food are not impaired.

The Microwave solo function is recommended for cooking casseroles, rice pudding, etc.

Any microwave-safe cookware is suitable for use.

- Set the cookware in the middle of the glass tray on the 1st level runner from the bottom.

- Set a duration and power level.

There are six microwave power levels available: *HI - - - - LO*

When using a function with microwave, a duration must always be set.

Microwave tips

- Food with a thick skin or peel, such as potatoes and sausage, should be pierced several times before cooking to allow steam to vent and prevent the food from bursting.
- Boil eggs in shell only in a specially designed microwave egg boiling device, otherwise the eggs may burst even once taken from the oven.
- Eggs can be cooked without their shells in the oven only if the yolk has been punctured. The pressure could otherwise cause the egg yolk to explode.
- Do not cover the food when using combination functions.
- Add a little water when cooking vegetables that are not fresh in the oven. Fresh vegetables cook quicker.
- Food from the fridge needs a longer cooking time than food at room temperature.

Baking

Convection bake

Default temperature 325°F (160°C)

Recommended for cookies, quick batters, pastry, phyllo, and strudel.

Any heat-resistant cookware is suitable, e.g. casserole dish, china, earthenware. However shiny, thin pans are not recommended.

Recommended runner levels:

Cakes 1st runner from bottom

Flat items 2nd runner from bottom (cookies, pastries, etc).

Baking on 2 runners 1st and 3rd or 2nd and 3rd runners from the bottom . . . depending on the height of the food

Baking tips

- You can also program a duration (see "Selecting cooking times"). However items should not be prepared too far in advance, the dough will dry out and the leavening agent will lose its effectiveness.
- Place rectangular or square cake pans with the longer side across the width of the oven. The heat will better distribute.

Combination bake

Default temperature 325°F (160°C)

This function is suitable for baking items with a longer bake time e.g. dough, cake, cheesecake, etc.

This function combines the functions Microwave and Convection Bake. Heat reaches the food immediately shortening cooking times while still achieving a browned finish.

Heat-resistant glass or ceramic bakeware is suitable so microwaves can get through the material.

Metal cake pans are not recommended with this function. Metal pans reflect microwaves causing longer cooking times. In addition, the use of metal pans could cause sparking.

Place the pan on the glass tray so that it does not touch any of the appliance walls. If sparks continue to form, do not use that pan again for combination mode.

- Set the cake pan in the middle of the glass tray on the 1st level runner from the bottom. Be sure that the pan does not touch the walls.

The baking time is shortened.

- Set the microwave to "L0" for the entire duration of baking.

Convection broil

Default temperature 400°F (200°C)

The function Convection Broil is designed for broiling food in which a brown crust is desired like shish kebabs, roasts and poultry.

Roasting pans and heat-resistant glass pans are suitable for use with this function.

The cookware must have heat-resistant handles.

- Select a duration and/or temperature if desired.

If possible allow the oven to preheat for 5 minutes.

- Place the combi rack on the glass tray and place the food on it.
- Depending on the size of the food insert the glass tray on the 1st or 2nd level runner from the bottom.

Combination broil

Default temperature 400°F (200°C)

This function combines the functions Microwave and Convection Broil allowing a microwave power level to be selected as well as a temperature.

Use only microwave-safe, heat-resistant cookware, no metal lids.

- Select a duration, power level and/or temperature if desired.

If possible allow the oven to preheat for 5 minutes before adding the microwave function.

The following microwave levels are recommended for broiling:

meat and fish *HI*
poultry *LO*

- Confirm with "OK".
- Place the combi rack on the glass tray and place the food on it.
- Depending on the size of the food insert the glass tray on the 1st or 2nd level runner from the bottom.

Broiling

Maxi Broil

Maxi Broil is done at a fixed temperature and cannot be changed.

This function is designed for browning and searing large quantities of meat, such as ribs or chops, or for browning large dishes.

- Depending on the size of the food insert the glass tray on the 1st or 2nd level runner from the bottom.

Micro Broil

Micro Broil is done at a fixed temperature and cannot be changed.

This function combines the programs Microwave and Broil allowing a power level to be selected.

- Place the combi rack on the glass tray and place the food on it.
- Insert the glass tray on the 2nd level runner from the bottom. The 3rd runner level can be selected for very flat food.
- Select the power level desired.
- Confirm with "OK".
- Select a duration.
- Press "Start".

Broiling tips

- Slices should be cut evenly so that the broiling time is the same.
- Before placing food onto the combi rack baste it with oil, to avoid sticking.
- Turn the food at the half-way stage.

The defrost function allows you to defrost food at a consistent temperature.

Room-temperature air is distributed over the food by the fan on the rear wall of the oven.

Shelf levels

- Remove the frozen food item from the packaging, and place it on the glass tray or in a bowl.
- Depending on the size of the food item, select the 1st or 2nd runner from the bottom.

The time it takes to defrost the food depends on its type and weight. The temperature at which it was deep frozen will also make a difference.

Defrosting tips

- During the defrosting time turn, stir or separate the food several times. As a reminder a tone sounds and a message is displayed.
- Remove frozen food items from the packaging and place them in a dish.
- Meat and poultry should be fully thawed before cooking. Do not use the defrosting liquids.
- Fish does not need to be fully defrosted before cooking. Defrost so that the surface is soft enough to absorb seasonings.
- Cook food immediately after defrosting.

Defrost / Heat and Cook

To defrost, heat and cook at the same time use the function Microwave or a combination function.

Microwave solo

This function is suitable for frozen food, which does not require browning.

Frozen meals can be defrosted and then reheated or cooked. Consult the manufacturer's instructions.

- Remove the food from its packaging and place in a covered microwave safe dish on the 1st level runner.
- Select a duration and power level.
- Select "OK".

For combination functions

This function is recommended for pre-cooked dishes, which require heating and browning.

- Place the frozen food in a microwave safe container and set it on the glass tray.
- Set the glass tray in the 2nd runner level. **Do not** cover the food.

Frozen foods in an aluminum trays **must** be set directly on the glass tray.

- Select a duration and power level.
- Adjust the temperature if necessary.
- Select "OK".

During thawing, heating, cooking

- Items should be stirred several times during the process.
Separate and turn slices of meat half-way through the program.

After defrosting / heating and cooking

- Let the food stand for a few minutes at room temperature so that it can take on a more uniform temperature throughout the dish.

After heating foods, especially baby food, always stir or shake, then test the temperature before serving. This reduces the danger of scalding.

Use caution when removing dishes from the appliance.

 Let the oven cool before cleaning the interior, the inside door and the gasket. Danger of burns!

Do not use a steam cleaner to clean the appliance. Pressurized steam could cause permanent damage to the surface and to components of the oven.

Clean the oven after every use, accumulated soiling makes cleaning difficult and could damage the appliance.

Never use abrasive cleaners, scouring pads or steel wool on any part of the oven. They will damage the surfaces.

Do not use caustic (oven) cleaners when the oven is hot, even if the cleaner instructions state otherwise. Caustic cleaners sprayed on hot metal surfaces will discolor the oven. Only use caustic oven cleaners on a cool surface.

Do not spray oven cleaners into any openings

Do not use the Microwave function if the door or gasket is damaged. Call Technical Service.

Interior

The revolutionary PerfectClean enamel is a smooth, nonstick surface that cleans easily with a sponge.

Clean spills on PerfectClean surfaces as soon as possible to prevent stains.

- Clean the interior, the inside of the door and gasket with a sponge and a solution of warm water and non-abrasive liquid detergent. Avoid using too much water, this could penetrate the openings.
- Dry with a soft cloth.
- Check the door and gasket at regular intervals for any sign of damage.

Cleaning tips

Juices and cake mixtures

Soiling such as spilled juices and cake mixtures are best removed while the oven or tray is still warm. Spilled fruit juices may cause lasting discoloration of the surfaces but will not affect the performance of the oven.

Hard-to-clean spills

Place a heat-resistant cup of water in the oven and bring it to a boil. The steam will condensate on the interior walls making it easier to clean.

Neutralizing odors

Place a heat-resistant cup of water and lemon juice in the oven and simmer for a few minutes.

Cleaning and Care

To avoid permanent damage to PerfectClean treated surfaces, avoid:

- scouring cleansers such as scouring powder, scouring liquid, and pumice stones
- ceramic stove-top cleaners
- steel wool
- scouring pads, such as pot scrubbers, or used sponges that still contain abrasive cleanser residue
- oven spray on PerfectClean surfaces at high temperatures or long application times

Interior ceiling

To clean the interior ceiling, the upper heating element can be lowered.

Wait for the upper heating element to cool before lowering it. Danger of burns.

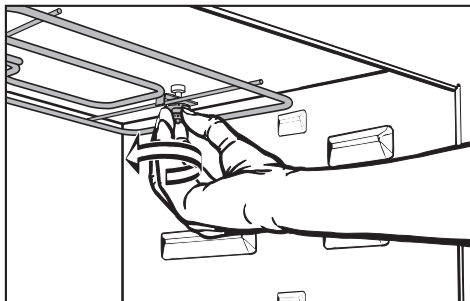

- Unscrew the nut.

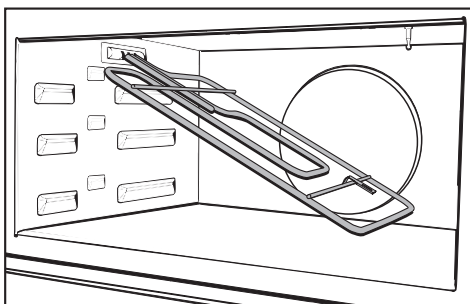

- Lower the upper heating element.

Do not use force! It may cause damage.

- After cleaning move the upper heating element back to its original position. Tighten the nut.

Inside of door with door seal

 The inside of the door remains hot after use. Danger of burns!

Clean the inside of the door and the door seal with a clean sponge cloth, dish liquid and warm water, or a clean, damp microfiber cloth. Then, dry with a soft cloth

 Inspect the door and the door seal for damage. In the event of any damage, do not use the microwave function of the appliance until it has been repaired by a customer service technician.

Glass surfaces are vulnerable to scratching. Scratches can lead to shattering of the glass surface.

Front of appliance

Remove spills as soon as possible. Otherwise the soiling may become hard to remove.

If spills are allowed to sit for an extended period of time or if unsuitable cleaning agents are used the surfaces may discolor or change.

- Clean the front of the appliance with a clean sponge or cloth, dish liquid and warm water, or a clean, damp microfiber cloth. Then dry with a soft cloth.

Glass cleaners **may be used** to clean the exterior. However **do not** allow them to sit or "puddle", this can cause damage to the surface.
Remove the cleaner promptly.

To better maintain your appliance avoid the following:

- cleaners containing soda, ammonia, thinners, or chlorides
- cleaners containing descaling agents or lime removers,
- abrasive cleaners,
- stainless steel cleaners,
- dishwasher soap (powder),
- caustic (oven) cleaners,
- scouring pads, steel wool, hard brushes,
- metal scrapers.

Cleaning and Care

Accessories

Combi rack

The combi rack has been treated with PerfectClean. Do not wash in the dishwasher.

- Wash the combi rack using a sponge and a solution of warm water and non- abrasive liquid detergent.
- Dry with a soft cloth.

Glass tray

- Clean the glass tray in the dishwasher or wash it by hand.

Do not use abrasive cleaning agents, they will damage the surface.

Boiling wand

The boiling wand can be washed in the dishwasher or by hand.

Frequently asked questions

Repairs should only be carried out by a qualified and trained person in accordance with local and national safety regulations. Unauthorized repairs could cause personal injury or machine damage.

Why is the display dark?

| Possible fault | Solution |
|--------------------------------------------|----------------------------------------------------------------------------------------------------|
| The appliance is not correctly plugged in. | Check the plug. |
| The circuit breaker has tripped. | Check the breaker. |
| The display setting is set to "Off". | See "Settings  ". |

What is a function does not work?

| Possible fault | Solution |
|-------------------------------------------------------------------------------|---------------------------------------------------------------------------------------------------------------------|
| The door is not closed properly. | Be sure the door is closed properly, otherwise the oven will not function. |
| A power level and duration have not been set for the microwave function. | For a microwave function, ensure that a power level and duration have been set. See "Using the oven - Microwave". |
| A power level, time and/or temperature has not been set for a combi function. | During a combi function, a power level, time and a temperature must be set. See "Using the oven - combi functions". |

Why is there no noise when the oven door is opened?

This is normal. If the door is opened during operation, a safety contact switch causes the heating elements and the fan to shut off.

Frequently asked questions

Why is a noise heard after turning the oven off?

This is normal. The fan will continue to run for a short time to cool the oven. When the oven has cooled sufficiently, the fan will turn off automatically. The fan will stop if the door is opened during the cooling phase. The fan will continue when the door is closed again until the cooling phase is complete.

Why are there strange noises when the microwave oven is being used?

| Possible fault | Solution |
|-------------------------------------------------------------------|---------------------------|
| Sparks are created by the use of dishware with a metallic finish. | See "Selecting cookware". |
| The food is covered with aluminum foil. | Remove the aluminum foil. |

Why does the oven operate but the light is off?

The light bulb is bad. See "Frequently asked questions - Changing a light bulb".

Fault messages "F XX" appear in the display.

Contact Miele's Technical Service Department.

Why is there uneven browning?

| Possible fault | Solution |
|-------------------------------|----------------------------------|
| Oven temperature too high. | Use a lower cooking temperature. |
| Shiny or thin pans were used. | See "Selecting cookware". |

Changing the light bulb

 To reduce the risk of electric shock, disconnect this appliance from the power supply by shutting off the power main or tripping the circuit breaker.

The bulb cover is comprised of two parts: a glass cover and a frame. Hold the bulb cover firmly so it does not fall. As a precaution, place a dish towel on the floor of the oven and the open door.

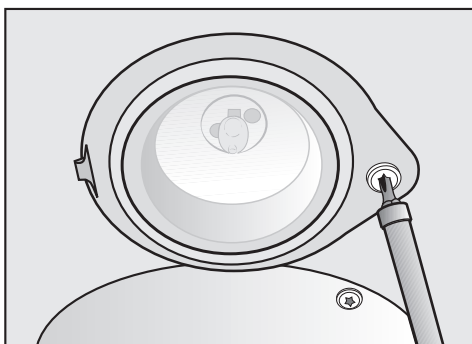

- Unscrew the bulb cover with a Torx screwdriver (T20) and remove the cover.
- Pull out the halogen bulb.

Only use the following light bulb: 12 V, 10 W, 572 °F (300 °C) heat resistant, socket G4, type 64418 made by Osram.

Do not touch the new light bulb with your fingers; touching the bulb will reduce its life. Follow the bulb manufacturer's instructions.

- Insert a new halogen bulb.
- Place the glass cover into the frame and fasten the bulb cover: Insert the tip of the frame into the recess in the oven ceiling. Press the frame into the oven ceiling and tighten the screw.
- Restore power to the appliance.

Technical Service

In the event of a fault which you cannot easily fix yourself, please contact the Miele Technical Service Department at the phone number on the back of this booklet.

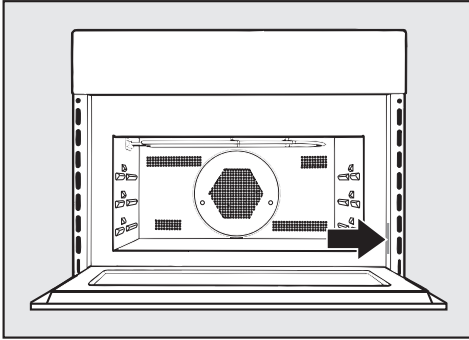

When contacting Technical Service please quote the serial number and model of your oven. This information is visible on the silver data plate along the right side of the oven.

MieleCare

(USA only)

MieleCare, our Extended Service Contract program, gives you the assurance of knowing that your appliance investment is covered by 5 years of worry free ownership. *MieleCare* is the only Extended Service Contract in the industry that guarantees repairs by a Miele Authorized Service Provider using genuine Miele parts. Only genuine Miele parts installed by factory trained professionals can guarantee the safety, reliability, and longevity of your Miele appliance.

Please note that unless expressly approved in writing by Miele's Service department, Extended Service Contracts offered by other providers for Miele products will not be recognized by Miele. Our goal is to prevent unauthorized (and untrained) service personnel from working on your Miele products, possibly doing further damage to them, you and/or your home.

To learn more about *MieleCare* Extended Service Contracts, please contact your appliance dealer or visit us online at:

<http://mieleusa.com/mielecare>



Installation Instructions

Information is subject to change. Please refer to our website to obtain the most current product specification, technical & warranty information.

Electrical connection

 **CAUTION:** Before servicing, disconnect the power supply by either removing the fuse, shutting off the power main or manually "tripping" the circuit breaker.

Installation work and repairs should only be performed by a qualified technician in accordance with all applicable codes and standards. Repairs and service by unqualified persons could be dangerous.

Before connecting the appliance to the power supply, make sure that the voltage and frequency listed on the data plate correspond with the household electrical supply. This data must correspond in order to prevent machine damage. Consult an electrician if in doubt.

Only operate the appliance after it has been installed into cabinetry.

The appliance must be plugged into an appropriate outlet that is installed and grounded in accordance with all local codes and ordinances.

Power supply

The oven comes equipped with a 5.7 ft. (1.7 m) power cord with a NEMA 14-30 P molded plug ready for connection to a:

120/240V, 20 A, 60 Hz power supply.

or

120/208V, 20 A, 60 Hz power supply.

WARNING: THIS APPLIANCE MUST BE GROUNDED

Installer:

Please leave these instructions with the consumer.

Miele appliances can be installed flush or proud. Discuss your installation requirements with your architect, designer and installer.

Installation options

The appliance is designed for installation under a countertop, in a tall cabinet or in a tall cabinet in combination with an oven.

Installation under a countertop

When installed under a cooktop regard the installation instructions and dimensions of the cooktop.

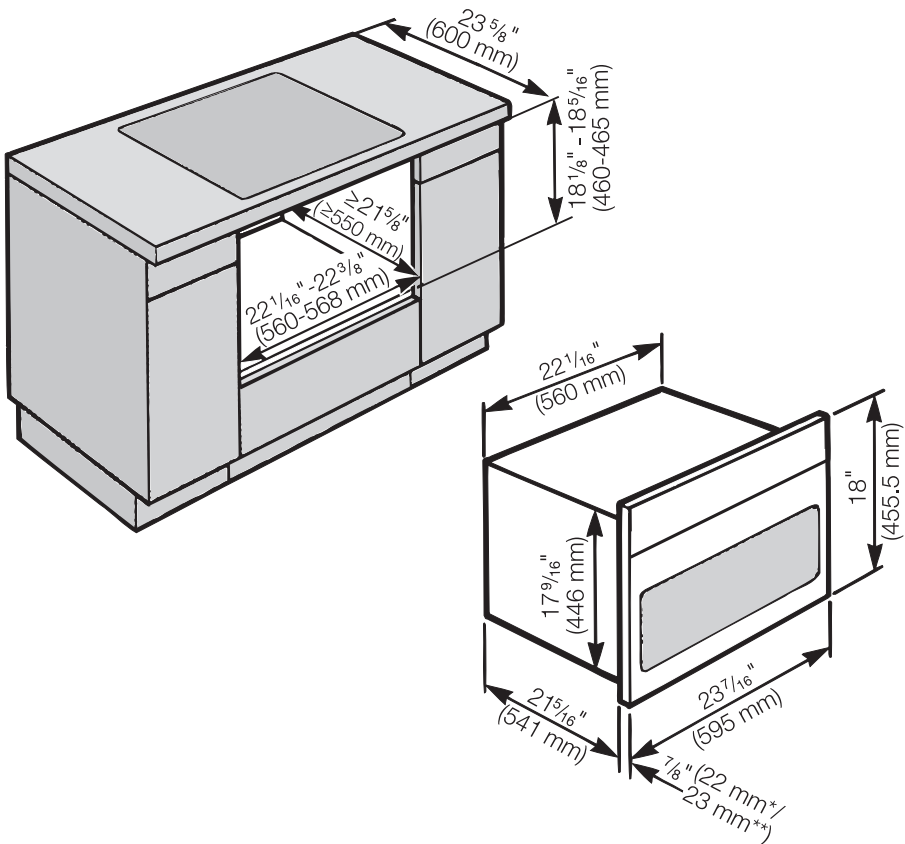

* Appliances with glass front

** Appliances with metal front

Installation

Installation in a tall cabinet

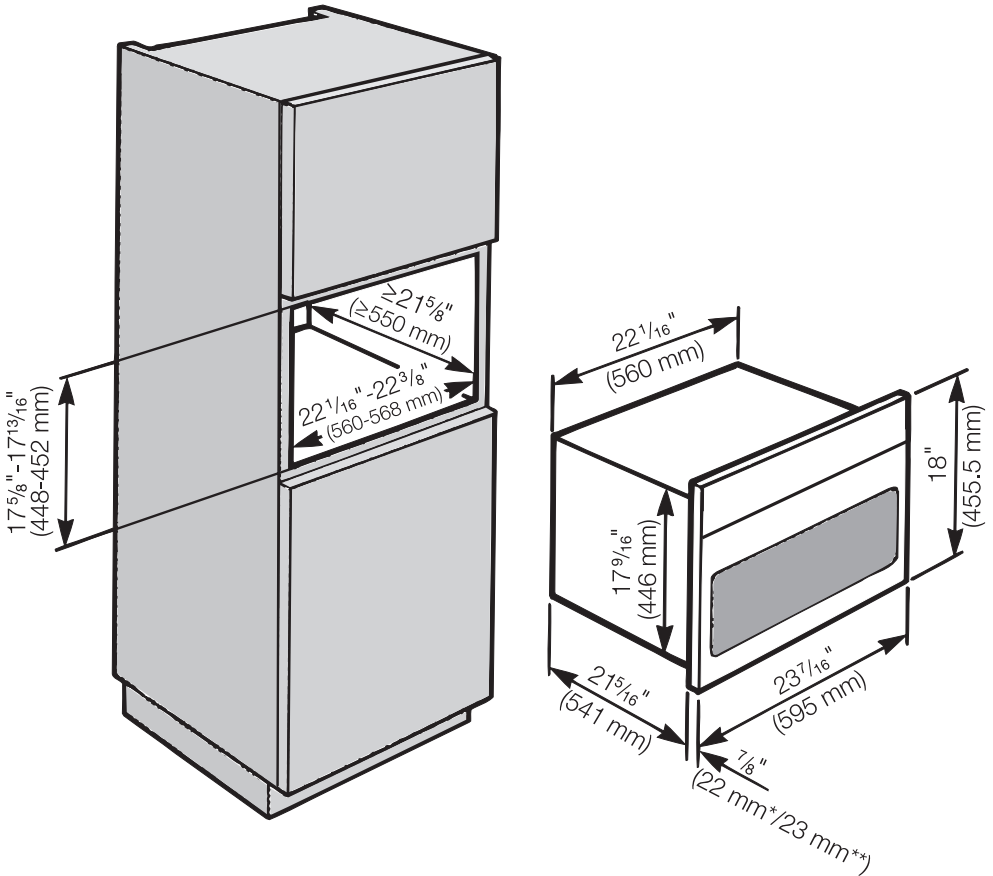

* Appliances with glass front

** Appliances with metal front

Installation in a tall cabinet in combination with an oven

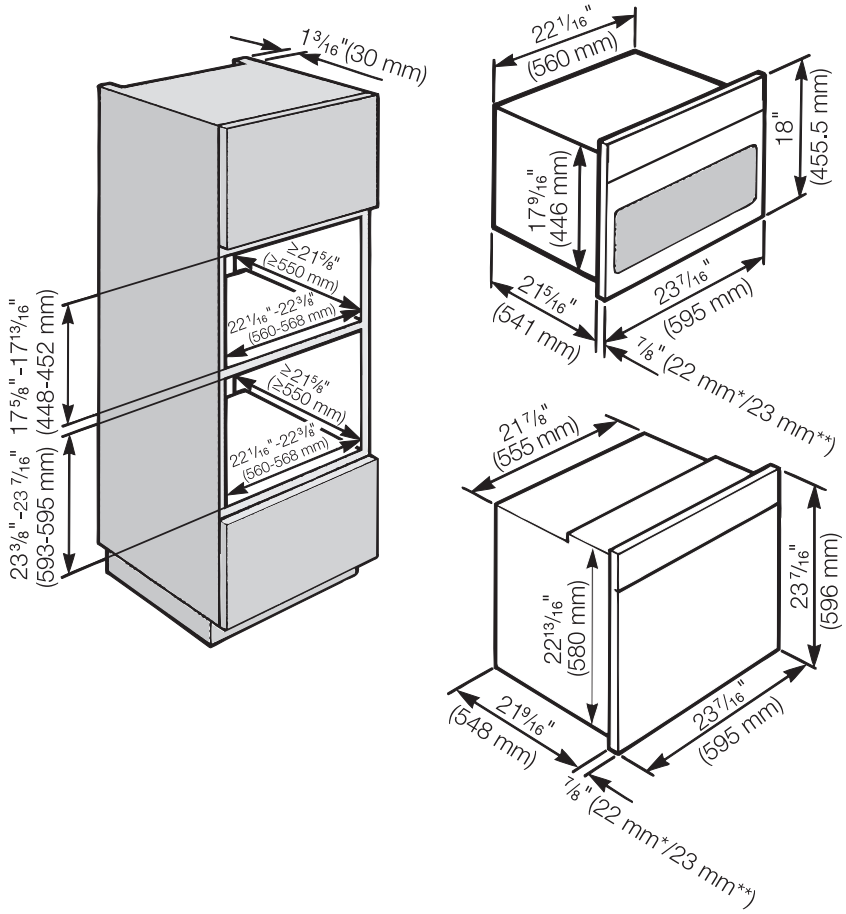

* Appliances with glass front
 ** Appliances with metal front

Installation

Appliance front dimensions

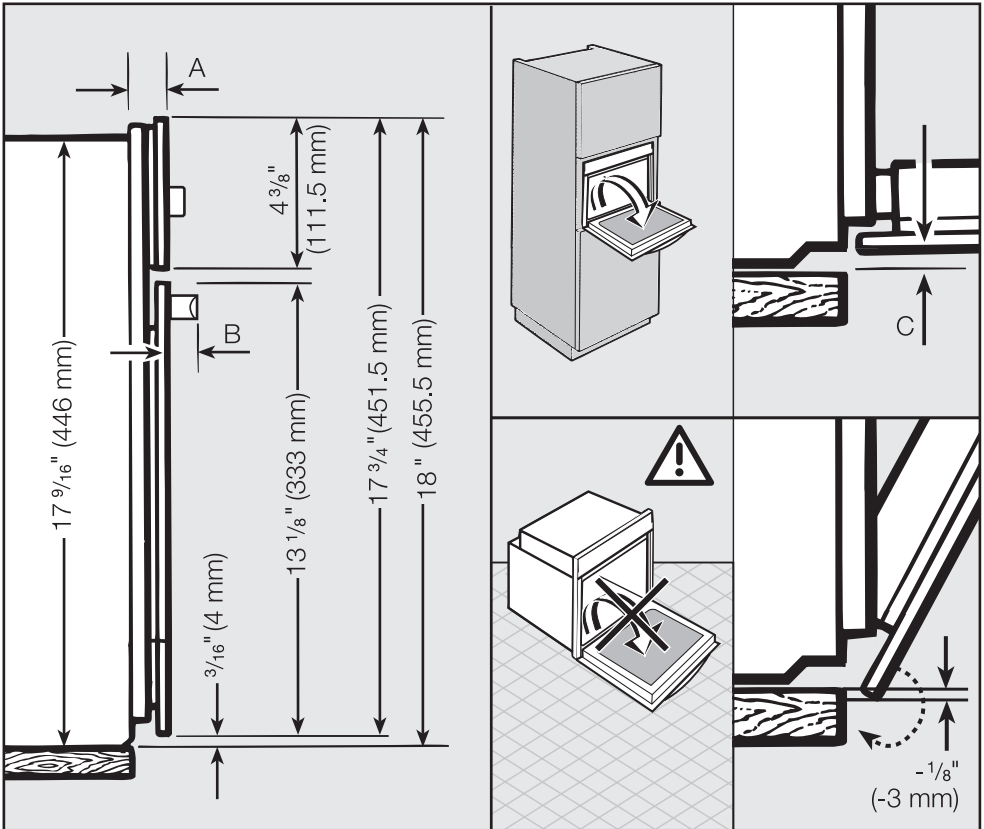

A $\frac{7}{8}$ "
(Appliances with glass front: 22 mm / Appliances with metal front: 23 mm)

B H 4044 BM: $2 \frac{3}{16}$ " (55 mm)

C Appliances with glass front: $\frac{1}{16}$ " (1.5 mm)
Appliances with metal front: $\frac{1}{32}$ " (0.5 mm)

Installation

 Do not use the appliance until it has been properly installed.

- Connect the oven to the electrical supply.
- Set the oven into the cabinet niche, push it all the way in and align.

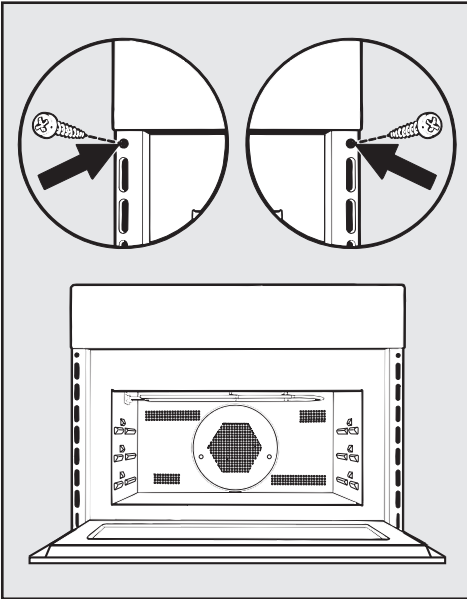

- Open the oven and secure the appliance with the two supplied screws at the side panels of the cabinet.

Do not use the appliance until it has been properly installed.

**Please have the model and serial number
of your appliance available before
contacting Technical Service.**



U.S.A. Miele, Inc.

National Headquarters

9 Independence Way
Princeton, NJ 08540
Phone: 800-843-7231
609-419-9898
Fax: 609-419-4298
www.mieleusa.com

Technical Service & Support Nationwide

Phone: 800-999-1360
Fax: 888-586-8056

TechnicalService@mieleusa.com

Canada Miele Limited

Headquarters and Showroom

161 Four Valley Drive
Vaughan, ON L4K 4V8
Phone: 800-643-5381
905-660-9936
Fax: 905-532-2290
www.miele.ca
professional@miele.ca
(commercial enquiries)

MieleCare National Service

Phone: 800-565-6435
905-532-2272
Fax: 905-532-2292
customercare@miele.ca
(general and technical enquiries)

Germany

Miele & Cie. KG
Carl-Miele-Straße 29
33332 Gütersloh