

# Haier

Microwave Oven  
Instruction for use

**AED-2485EG**  
**HMW24AED**  
**HMW24AEDSS**

## Warning!

### Electricity schematic diagram

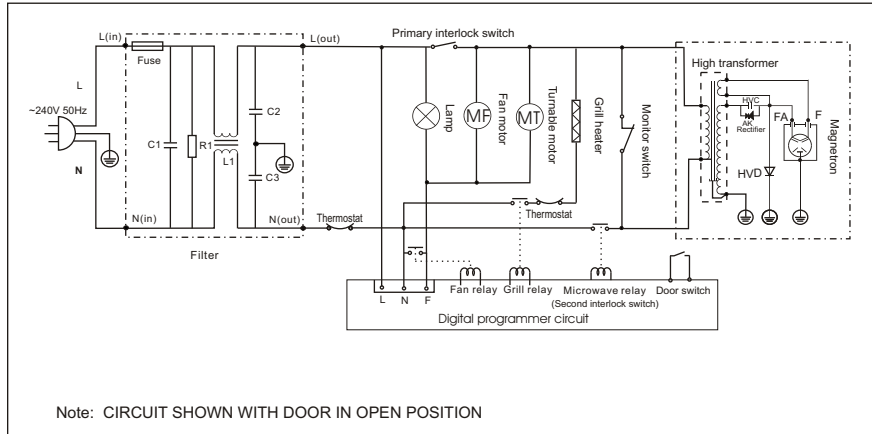

1. No one except the professional technicians can decompose the microwave oven. Electric shock danger may occur!
2. Do not put metal stick into the interlock hole at the front of the cavity. It may cause microwave leakage!
3. Do not add excessive force to opposite direction on the door. Otherwise the door may be deformed and cause microwave leakage.
4. Do not cook food with vacuum package or packed into enclosed container. For the food with skin, remember to puncture it before cooking.
5. Do not cook eggs with shell. It may cause bursting.
6. Remove the grease remained in the cavity. Otherwise it may cause smoking or fire in heating.
7. Do not use the microwave oven for purposes other than cooking.
8. Be sure to earth the microwave oven reliably in installation and usage.
9. Reserve enough space for the rotation of the tray. At least 5cm space above the microwave oven is required for heat radiation.
10. Do not put microwave oven in humid or high-temperature environment.
11. Do not touch the upper part of the shell and the outer screen of the door. It may cause scalding.
12. Do not run the microwave oven without load. It may damage the microwave oven.
13. Do not use metal container to cook with microwave oven. It may cause igniting phenomenon.
14. After long time cooking, the cavity is under high temperature. It is suggested to wait for some time to cool it down before next usage.
15. Before usage, please check if the cooking utensils are applicable for microwave oven.
16. When cooking food with plastic or paper package, be sure to check if it strikes a fire.
17. If there's smoking during cooking with microwave oven, please keep the oven door closed and pull off the power plug.
18. If you heat beverage, it will slowly expand. Be sure to watch out for bursting.
19. For those drinks or food prepared for children, be sure to stir or shake evenly and check the temperature before feeding to avoid scalding.
20. If the door, door frame or door seal is damaged, do not use the oven before it is repaired by the professional technicians.
21. During maintenance, be sure to switch off the power supply. To decompose the shell of the oven, be sure to have it done by professional technicians. The inner components are electrified, and may cause electric shock.
22. Children shall use the microwave oven under the instruction of adult, or use the oven by self after they have received complete instruction and description from the adult. The adult shall teach the children the general knowledge on the danger of operating the microwave oven.
23. The door seal and all of the relative parts shall be cleaned with soap liquor once each week to keep the cavity clean.
24. If the power cord is damaged, only the sellers or professional technicians authorized by the manufacturer can make maintenance to avoid any electric shock danger.
25. If you use cook utensils not recommended by us, be sure to watch out for the cooking proceeding in the microwave oven.
26. If you heat liquor, in handling the liquor, please notice that the boiled liquor may have delayed bursting and cause scalding.
27. Small amounts of food require shorter cooking or heating time. If normal times are allowed they may overheat and burn..

# Operating panel

## Screen Display and key functions

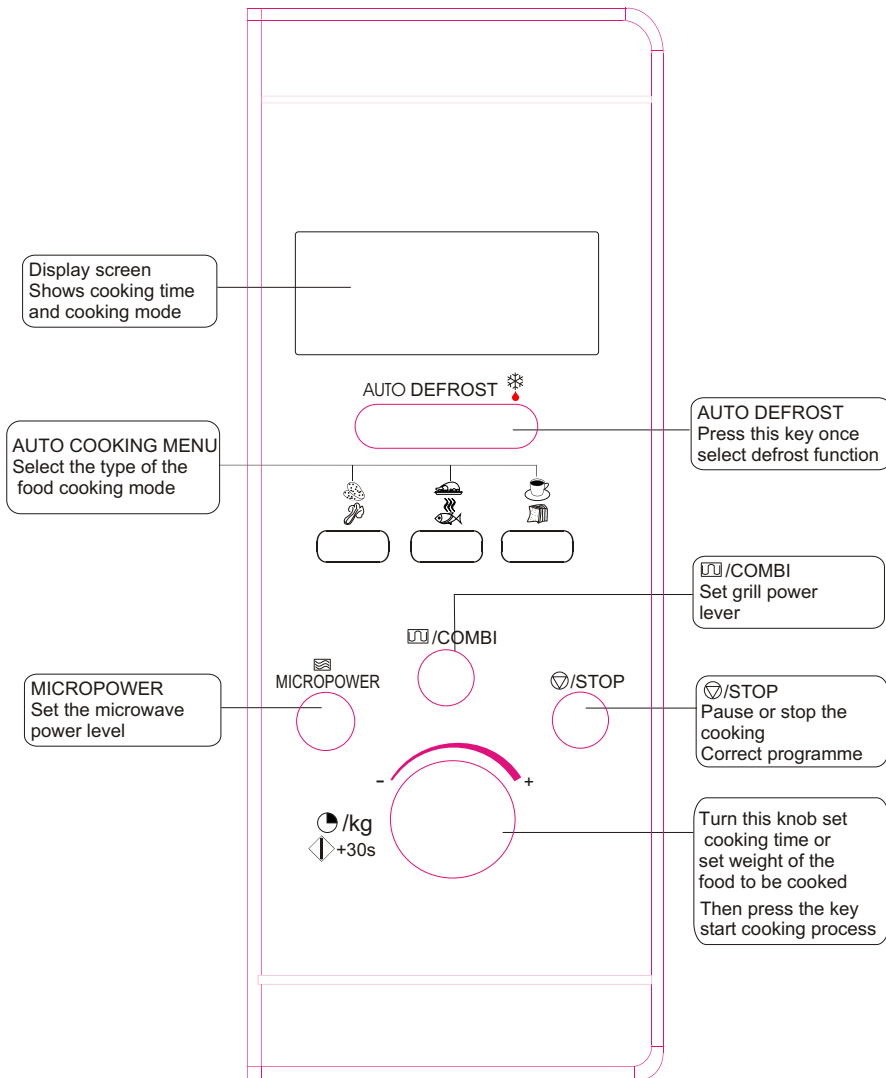

# Contents

# Page

Electricity schematic diagram .....	In front page
1 Potential dangers .....	2
2 Where to install the oven .....	3
3 Installing the oven .....	3
4 Rating plate .....	4
5 Plugging in your appliance .....	4
6 Using the microwave oven .....	5
7 How to operate your microwave oven .....	6
8 Cleaning and care .....	9
9 Customer support service .....	9/10
10 Calling the customer support service .....	10
11 Guarantee .....	10
COMPONENTS .....	11
Operating panel .....	12
Warning .....	13

**Caution !** Microwave ovens may only be installed, plugged in and started up in full compliance with the instructions for use. Therefore, please read the instruction manual carefully from start to finish before you start to use your appliance. The manufacturer is not liable for any damage caused by failure to pay heed to the operating instructions when operating the appliance. Highlight the points that are especially important to you and keep this document in a place where it can be consulted at any time and be passed on to future owners. This appliance must be kept out of children's reach. Important !

The appliance(s) described in this instruction manual is / are solely designed for domestic use and may not be used for professional or commercial purposes.

You have chosen an excellent appliance which will serve you reliably for many years, if it is operated and maintained properly.

Detailed drawings (FIG.A) with a legend you shall find on the page 11 of this manual.

Should your newly purchased appliance replace an old microwave oven, cut off the power cable of the old appliance as close as possible to the cabinet. Please have the old appliance ecologically disposed off by a company specialised in environmental protection. (ask your civic Centre)

## Using your oven

In the following, please find all important instructions for the use of the oven.

As this manual applies to several microwave ovens, some specifications may differ from model to model.

## 1 Potential dangers

**Caution !**

Microwave ovens may only be used to warm up or heat up food or drinks. Never use your microwave oven for other purposes such as drying textiles or other objects, let alone life animals. This may cause acute fire(s) or accident hazard.

1. If you install or start up your microwave oven without first reading the instructions for use:

- Misuse may damage your health and endanger your life.
- Mistakes made in installation and connection may potentially damage the appliance itself and your kitchen furniture

2. Over boiling

- When heated in a microwave oven, liquids may overheat beyond their boiling point without you being able to see it (boiling causes non visible bubbling).

Caution: By merely touching a serving dish as you take it out, steam bubbles may unexpectedly and suddenly form and the liquid in the serving dish may unexpectedly boil over. (Danger to get severely scalded)

You can prevent such an occurrence, by simply putting a clean glass rod into the dish, filled with liquid. However before removing the serving dish, observe if the boiling liquid bubbles up as usual.

- In mixed food with different moisture levels, the microwaves heat up the moister ingredients far stronger.
- Baby food heated up in glasses or bottles may only be handed to your child after having checked the temperature of the food or drink.
- As different ingredients may be warmed up at varying degrees, the dish/bottle containing baby food may feel only lukewarm, whereas the food inside is far more heated up. For this reason, always shake or stir the baby food evenly so that the heat is distributed.

3. Suitable cooking ware

Always ensure that your dishes and pots are compatible with microwave ovens.

Cooking ware made of the following materials is best suited:

- Fire-resistant glass or ceramics
- Heat-resistant and microwave suited plastic
- Heat-resistant porcelain / stoneware

The following materials may be used only for brief operation (e.g. warming up) as long as it is under constant supervision in case of fire and the manufacturer explicitly states that the materials are suitable for microwaves.

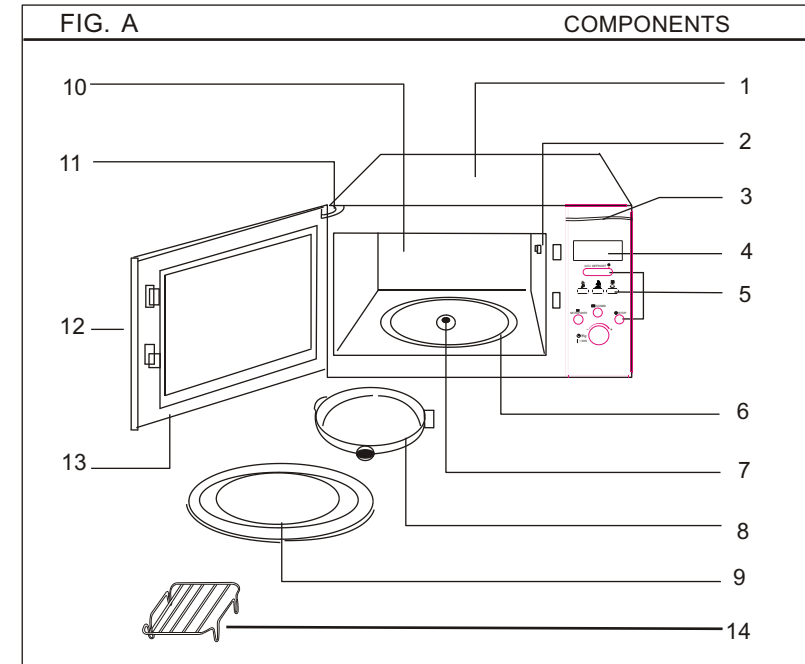

## Legend of Components

Availability of components depending on Mod. / Type of appliance

1 - Cabinet	10 - Oven interior
2 - Interior light	11 - Door hinge
3 - Control panel	12 - Door
4 - LED display	13 - Door seal
5 - Operate button	14 - Gridiron
6 - Circular track(for turntable undercarriage)	
7 - Turntable drive	
8 - Turntable undercarriage	
9 - Turntable	

Customer service jobs resulting from improper operation of the oven are liable for payment even during the guarantee period.

What is when.....

- Is the plug firmly inserted in the socket?
- Is the power socket under current?

(test this by plugging in another kitchen appliance)

- Is the fuse intact?
- Was the timer set properly? (first turn beyond the required time and then back accordingly)
- Does the oven door close tightly?
- Is anything stuck in the door?

Under no circumstances should you subject the appliance to any tests other than those described here or attempt to repair it yourself by technical means.

### Warning !

The interior lamp may only be replaced by specially trained customer service personnel who is aware of the related dangers.  
The appliance works independently from the interior light. It can thus also be operated easily even if the interior lamp has failed.

Steam escaping from the air vent is quite normal during operation. This is not a malfunction.

## 10 Calling the customer support service

To ensure prompt help when needed, please have ready the following data before calling the customer support service:

- Appliance Type / Model (see rating plate)
- Date of purchase
- Name and location of your dealer
- Description of the malfunction

The address and phone number of the customer support service centre responsible for your appliance can be found in the attached customer support service directory, or in the guarantee card. Otherwise contact your dealer .

## 11 Guarantee

Please note the general guarantee terms and the guarantee period stated in the attached guarantee card. If the appliance documentation does not include a guarantee card, please contact your dealer .

The manufacturer works constantly at the further development of all products. Please therefore bear this in mind as the form, set up and technology are subject to change, without prior notice.

- Wickerwork
- Wood / wooden skewer
- Plastic cups / dishes etc.
- White paper trays / cartons

### Very important !

The following items are under no circumstances suitable for microwave cooking:

- Metal containers, cutlery or skewers
- Containers with metal trimming (e.g. gold rim )
- Bags sealed with metal parts (clips)
- Cartons coated with plastic film or foil
- Coloured or recycled paper

Metal objects may trigger off unwanted sparking and potentially damage the appliance.  
Coated cartons, coloured or recycled paper may contain substances that may lead to overheating and fire.

If your appliance is also equipped with a fan or a grill function, make sure the dishes you use have a high heat resistance.

## 2 Where to install the oven

1. Before installing your new appliance, you need to check as for visible external damage. Under no circumstances should the appliance be started, if it is damaged. Therefore, thoroughly check the appliance as for:

- Damaged packaging, indicating that the appliance may have been damaged during shipment
- Damaged cabinet
- Damaged door glass panel
- Visible damage to the cable / plug

If you suspect any damage, please have the appliance tested by the customer support service. At all costs prevent the emission of any hazardous microwave radiation by not starting up a damaged oven.

## 3 Installing the oven:

(FIG. A)

- a) Unpack the appliance
- b) Remove all objects from the inside of the oven.
- c) Carefully remove all plastic films and stickers from:
  - the cabinet
  - the door
  - the Turntable axle - drive shaft

Failure to carefully remove plastic films and stickers may lead to a fire hazard.

d) Clean the oven interior with a damp cloth.

Do not use sharp cleansers or scouring agents!

e) Unpack the turntable (not all models are equipped with) and its undercarriage

- f) Place the undercarriage in the circular track on the oven interior floor  
g) Lay the turntable onto the undercarriage. By gently turning it, the guide fits into the drive shaft.

- Place the appliance on an even and non-skid surface.  
It must be stable enough to easily support the appliance even if the oven contains goods.
- Leave a space of at least 15 cm between the foremost edge of the worktop and the front of the oven door .  
You will thus prevent the appliance from tilting forward when the door is open.
- Install the oven in a place where it is protected against splashing water or dripping liquids.
- Never operate the appliance outdoors. Sunlight and humidity may impair operational safety.
- Never expose your microwave oven to direct sunlight (overheating hazard).
- Do not install the appliance in the immediate vicinity of heat sources such as radiators or cookers.
- The following minimum clearances between other objects / walls must be maintained for safety purposes:
  - Side l/r clearance at least 5 cm
  - Rear clearance at least 30 cm
  - Upper clearance at least 30 cm
- The appliance must not be built into a cupboard.  
The oven must not be built in underneath a panel or a cupboard.
- For some models a built under - mounting set is commercially available. Please ask your dealer or the respective customer support service.

**CAUTION!**

During operation clouds of steam escape through the air vents of the appliance and it may get very hot within the space of the above mentioned minimum clearances. The microwave oven should thus be installed so that no objects sensitive to heat or moisture are located near the minimum clearances. Avoid any possible overheating of the oven caused by unintentionally covering or sealing the air vents. When in operation the base of the oven may become very hot. The worktop must thus be accordingly heat-resistant.

**4 Rating plate**

The rating plate with technical specifications is located on the cabinet, at the rear of the oven.

**5 Plugging in your appliance**

Your appliance must be connected to a power socket with grounded connection, which complies with the respective regulations and has been installed by authorised specialists.  
Before plugging the appliance into the wall socket, make sure that the voltage(V) and fuse amperage (A) specified on the rating plate of the oven correspond with the electrical power supply in your home. If these specifications do partly or not at all correspond, immediately contact your local customer support service or your dealer and do no plug in the appliance under any circumstances.

**8 Cleaning and care****Caution !**

The microwave oven must be unplugged from the power supply before cleaning it (on the external or interior side).

Pull out the power plug, or activate fuse safety switch.

If you cannot reach the plug, keep the oven door open (also when cleaning the outside).

Only in this way you can prevent the appliance from being switched on when the function keys or switches are inadvertently activated.

**1. Cleaning the cabinet**

Caution ! Under no circumstances should water or a cleaning fluid get into the inside of the oven.

This is particularly important when cleaning around the air vents or rear wall.

Otherwise serious accidents may ensue due to electric shock and the appliance may be damaged.

- Only use clear water with just a little washing-up liquid for cleaning. Do not under any circumstances use sharp cleaning or scouring agent. Lastly wipe the cabinet dry with a soft cloth.
- Carefully remove food particles and dirt deposits between the door and cabinet, so that the door always shuts properly and tightly.

**Warning !**

Under no circumstances should you continue to use the appliance if you have detected any damage on the door seal or on the adjoining surfaces. The same applies to damage detected on the door itself or door hinges. Otherwise hazardous microwave radiation may escape from these locations. This kind of damage must be repaired by a trained customer service engineer, before you can use your appliance again.

**2. Cleaning the inside of the oven**

Never pour water into the oven interiors . Water may enter the interior of the oven through the air vents and damage the appliance. Moreover serious accidents can ensue due to electric shock.

- Clean the oven interior thoroughly. Particles of fat and food may overheat and potentially cause fire hazard. Moreover food and dirt deposits inside the oven affect the performance of the microwave oven.
- Use only clear water with a little washing-up liquid to clean the interior of the oven. Do not under any circumstances use sharp cleaning or acids. Lastly wipe the cooking chamber dry with soft cloth.

**3. Cleaning the turntable**

- Thoroughly clean the turntable (if equipped with) after every use to prevent smoke from developing due to food particles.

**CAUTION ! The turntable might still be hot.**

- Likewise clean the turntable undercarriage and the oven interior regularly, so that it always works perfectly.

**9 Customer support service**

Check on the enclosed guarantee card or the separately enclosed customer service directory which firm is responsible for the customer support service of your appliance.

If your appliance documentation does not mention the responsible customer support service, please contact your dealer.

If your appliance does not work despite observance and compliance with all tips and guidelines described in these instructions for use, then please do the following check "What is when...", before you call the customer support service:

## AUTO DEFROST

This function can be used to defrost deep- frozen food fast and gently.

According to the weight set , the appliance automatically determines the required defrosting time. You have possibilities to set the weight.

**Example: Defrost 0.8kg frozen food**

1. Press key once

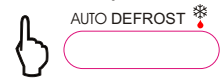

Screen display



2. Turn the knob clockwise until



Screen display



3. Press key

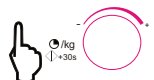

Screen display



Clock counts backwards

Note:

For previously cooked frozen food, during the cooking please turn the food over.

## CHILD LOCK

To protect children from accidents, the appliance is equipped with a lock mechanism "LOCK"

1. Under the standby mode press keys simultaneously



Screen display



Note:

When activating the lock function a buzz rings. All other function are now blocked.

2. To cancel the lock function hold the following keys pressed simultaneously





Screen display



Note:

When the lock function is cancelled a buzz rings. All other functions are now again active.

**NOTE:**

- If you want to temporarily stop a cooking session, press the /STOP key once and then you can start the cooking again by press +30s; or press the /STOP twice to cancel the cooking program altogether.
- After the cooking time ends, the system will beep five times .

When operating the microwave oven for the first time, make sure that:

- The power cable of the oven is not led underneath the oven base, which does get hot, and does not come into contact with sharp edges or hot objects.
- The power cable does not extend into the other kitchen work areas.
- The power cable does not droop from the work top and nobody can get caught in it.
- The power cable does not come into contact with moisture(e.g. when wiping the work top or rinsing).
- The power plug is easily accessible and can quickly be unplugged in case of danger
- The power plug is always firmly inserted in the socket and loose contact cannot cause any fire hazards.
- Slack power plugs or sockets must be immediately repaired by a skilled electrician.
- No curtains are nearby.

## 6 Using the microwave oven

1. Before switching on the appliance, you should familiarizes yourself with the following guidelines:

- Never operate the oven when it is empty otherwise it could get damaged.

To prevent the oven from being operated inadvertently without contents, always leave a glass of water in the cavity when the appliance is out of use.

- Never heat liquids or food(s) in sealed dishes

Within sealed dishes overpressure can quickly develop and thus cause the dish to burst. This leads to potentially serious accidents.

- The following items are also liable to burst due to developing overpressure: eggs in shells, nuts in shells or any food(s) vacuum packed in plastic foil.

Therefore, always pierce raw eggs on two sides and remove the foil or at least cut it open on one whole side, before you put it into the oven. Remove nutshells.

- Should the use of aluminium foil be recommended in a recipe, make sure that it tightly adheres to the cookware or food and a gap of at least 2.5 cm is left between the aluminium foil and the cooking compartment walls.

Otherwise sparking may occur inside the oven and the appliance could consequently get damaged.

- In order to ensure that the seal is constantly protected adequately against hazardous escaping microwaves, always make sure that:
  - No objects (dishcloths, parts of food packaging etc.) are caught between the door and cabinet
  - Door seal or door hinges are not damaged or soiled (also see section on "Cleaning and Care")

Do not touch - scalding hazard

During operation your microwave oven may present scalding hazards in the following components:

- on the door - glass panel
- on the lateral air vents
- on the underside of the oven
- on the top of the oven

2. Prevention of smoke or fire in the microwave oven

If food(s) overheats, smoke may develop or smouldering may start inside the oven. Food(s) with a high sugar or fat content are particularly prone to this hazard.



The microwave oven is therefore not suitable for:

- Frying
- Making popcorn
- Melting sugar or fats
- Cooking dried beans etc.
- When preparing food(s) with uncertain compositions, you should keep an eye on the appliance until the end of the set cooking time.

2.1 How to react when smoke develops inside the oven

Should smoke or fire develop inadvertently inside the oven, this problem can usually be easily overcome by taking the following correct steps:

- Whatever happens, keep the oven door closed.
- First thing, switch off the appliance immediately
- Then switch off the power supply by unplugging the appliance or activating the fuse safety switch.
- Open the oven to take out the burnt food only when you can no longer detect any smoke.

**CAUTION ELECTRIC SHOCK**

Under no circumstances should you attempt to extinguish smouldering or burning food inside the oven with water . In this case serious accidents may be caused by electric shock.

**7 How to operate your microwave oven**

**MICROWAVE COOKING**

You can choose from 8 different power levels. Set the desired power level before setting the cooking time.

Screen display P stands for % power

1	2	3	4	5	6	7	8
P100	P80	P70	P60	P50	P40	P30	P20

**Example: 10 minutes cooking with P50 power level**

1. Press key five times  
 Screen display **P50**

2. Turn the knob clockwise until  
 Screen display **10:00**

3. Press key  
 Screen display **9:59**

Clock counts backwards

Note: 1. The power level is displayed in the percent. With each pressing of the key MICROPOWER the power level reduces from p100 to P80 to P70to P60to P50 to P40 to P30 to P20 then start again from P100.  
 2. After expiry of the cooking time (display 0:00) a buzzer rings five times.  
 3. The maximum cooking time is 60 min.

**AUTO COOKING MENU**

Set the type and the weight of the food to be cooked in the AUTO COOKING function ,the required cooking time is automatically determined.

Screen display A stands for "Automatic"

A-1 Potato	A-2 Vegetable	A-3 Meat	A-4 Fish	A-5 Milk	A-6 Bread
---------------	------------------	-------------	-------------	-------------	--------------







**Example: Cooking of 0.4kg fish**

1. Press key twice  
 Screen display **A-4**

2. Turn the knob clockwise until  
 Screen display **0.4**

3. Press key  
 Screen display **12:30**

Note: 1. Set the AUTO COOKING MENU

 A-1	 A-3	 A-5	Press once
 A-2	 A-4	 A-6	Press twice

2. The weight within one menu and one type of food is displayed stepwise.  
 3. The weight grades in the "AUTO MENU" serve as a reference to the automatic cooking time.  
 4. Take note of setting the correct type of food in the AUTO COOKING MENU. (See table following)

**WEIGHT TABLE "AUTO COOKING MENU"**

Recipe	type	weight	METHOD
A-1	Potato	1	Weigh the potatoes after peeling, washing and cutting into a similar size. Put them into a glass bowl with lid. Add 45 ml (3 tablespoons) water when cooking 300-450g, add 60ml water (4 tablespoons) for cooking 500-750 g.
		2	
A-2	vegetable	0.2kg	Weigh the vegetables after washing, cleaning and cutting into similar size. Put them into a glass bowl with lid. Add 30 ml(2 tablespoons) water when cooking for 200-250g, add 45ml(3tablespoons) for 300-450 add 60-75ml(4-5tablespoons) for 500-600g. Stir after cooking. When cooking higher quantities stir once during cooking.
		0.4kg	
		0.6kg	
A-3	meat	0.1kg	Shield the edges with aluminium foil. Turn the meat over, in the course of the cooking. This programme is suitable for beef, lamb, pork, steaks, chops and minced meat.
		0.2kg	
		0.3kg	
A-4	fish	0.2kg	Shield the tail of a whole fish with aluminium foil. Turn the fish over during cooking. This programme is suitable for whole fishes as well as for fish fillets.
		0.4kg	
		0.6kg	
A-5	milk	0.2kg	Pour the liquid into ceramic cups only and reheat uncovered. Place one cup in the centre, 2 cups opposite to each other and 3 or 4 cups in a circle. Leave them to stand in the microwave oven. Stir drinks before and after standing time. Be careful while taking the cups out (see safety instructions for liquids).
		0.4kg	
		0.6kg	
A-6	bread	2piece	Put bread on a piece of kitchen paper and turn over, at the half time of cooking (oven keeps operating and is stopped, when you open the door). This programme is suitable for sliced bread .
		4piece	
		6piece	

**GRILL COOKING**

Small quantities and thin pieces can be browned in the grill function .and it is recommended to cook larger quantities and thicker pieces in the COMBINATION MICROWAVE & GRILL. The grill has three power levels. Select the power level most suitable for the kind of food to be cooked.

Power level

G	$\frac{2}{3}$	C-1	$\frac{1}{3}$	C-2	$\frac{2}{3}$
GRILL	GRILL	MICROWAVE	GRILL	MICROWAVE	

Note:

1. The power level G , C-1 and C-2 are displayed by pressing the key GRILL/COMBI once resp. Twice and three times.
2. Five buzz rings sounds, when the cooking time has expired.
3. The only grill function is suitable for grilling of small pieces only. Larger quantities and thicker pieces should preferably be cooked in the combined function

**Example: Grill for 5 min on power level C-1**

1. Press key twice  
 Screen display **C-1**

2. Turn the knob clockwise until  
 Screen display **5:00**

3. Press key  
 Screen display **4:59**

Clock counts backwards