

# Hotpoint Service and Spares

FOR SERVICE: If you have a problem with your appliance ring your local Service Office.  
 FOR SPARES and ACCESSORIES: To purchase spares and accessories send your Accessories Order Form to your Spares Centre. If the accessory or spare part you want is not on the form, contact your Spares Centre for prices and availability.

Please address all correspondence to Hotpoint Spares Centre or Hotpoint Service Office as applicable.

Service Offices and Spares Centres are open between 8.00am-5.00pm Monday to Friday, except on Public Holidays. 8.30am-12.30pm on Saturdays.

## EAST

● **ESSEX:**  
 Industrial Buildings, Beehive Lane, Chelmsford, CM2 9TE.  
 Post Codes RM & IG Tel: (0245) 492433  
 Remainder of Essex Tel: (0245) 269331

● **LUTON:**  
 5 Crawley Road, LU1 1HK. Tel: (0562) 452211  
 Cella Road, PE2 9JB. Tel: (0733) 64741  
 Spares Administration Dept. Tel: (0733) 556520

## LONDON

● **WEMBLEY:**  
 For Service  
 68 East Lane, HA9 7PQ. Tel: 081-904-4399  
 S. Herts and Middlesex Tel: 081-908-4722  
 Post Codes N, NW, E, EC Tel: 081-908-2511  
 Post Codes W, WC, SE, SW Tel: 081-904-0201

## MIDLANDS

● **BIRMINGHAM:**  
 For Service  
 Westgate, Aldridge, W Midlands, W69 8UX.  
 All other Post Codes Tel: (0922) 743376  
 Tel: (0922) 743377

● **NOTTINGHAM:**  
 For Spares  
 Ashling Street, NG2 3JB. Tel: (0602) 860387  
 For Service  
 West Ave, Nelson Estate, Talks, S17 1TN. Tel: (0782) 774511

## NORTH EAST

● **HULL:**  
 Custom House Building, Whitefriargate, HU1 2EU  
 Tel: (0482) 224777  
 8 Bebe House, Tower Road, Glover Est, District 11, NE37 2SH.  
 Tel: 091-417-3500/419-3535  
 Sandbeck Lane, LS22 4TW. Tel: (0937) 581261/581444 For Spares Tel: (0937) 581221

## NORTH WEST

● **WETHERBY:**  
 For Service  
 Mumford House, 26 Highgate, LA9 4SX. Tel: (0539) 724483  
 44/46 Station Road, Heaton Mersey, Stockport, SK4 3DT.  
 Manchester North Tel: 061-432 0513  
 Manchester South Tel: 061-442 8677

● **KENDAL:**  
 For Service  
 Tel: 061-432 0255

● **STOKE:**  
 7 Bridle Way, Merseyside. Tel: 051-525 2342/524 2339  
 Tel: 061-432 0255

● **PRESTON:**  
 24/25 Cannon Street, PR1 3NR. Tel: (0772) 824311

## SCOTLAND

● **GLASGOW:**  
 Holbeck House, 68 Carden Place, AB1 1UL. Tel: (0224) 642283  
 35 West Bowling Green Street, Leith, EH6 5NX. Tel: 031-554 1431  
 West Loque Road, Blythswood Estate, PA4 9EN.  
 Tel: 041-886 6241 For Spares Tel: 041-886 5611

## SOUTH

● **KENT:**  
 For Service  
 Larkfield Trading Est, New Hythe Lane, Larkfield, ME20 6SW.  
 CT, DA, ME & TN Kent Post Codes Tel: (0622) 716571  
 CR, KT, RH, SM Surrey & BR Kent Post Codes (0622) 790707  
 GU Post Codes in Surrey Tel: Southampton (0703) 667374  
 Tel: (0622) 716631

## SOUTHAMPTON

● **SOUTHAMPTON:**  
 For Spares  
 Unit R, Southampton Ind Park, Salisbury Rd, Totton, SO4 3SA  
 Tel: (0703) 601961/667374 For Spares Tel: (0703) 667393  
 ● **SUSSEX:**  
 For Service  
 1 Kingswood, North St, Hailsham, BN27 1DQ. Tel: (0323) 842733  
 69 Mutley Plain, PL4 6UH. Tel: (0752) 262631

## WALES

● **SOUTH:**  
 For Service  
 Conwy Rd, Llaneludno Junction, LL31 9RE. Tel: (0482) 562626  
 18 Western Ave, Bridgend Ind. Estate, Bridgend, CF31 3SL.  
 Post Codes CF, SA & SY23-25 Tel: (0656) 664121  
 Post Codes BS, GL (not 55), HR, SY15-18, LD1-8, NP. Tel: (0656) 655564  
 Tel: (0656) 766111

In accordance with its policy of progressive product design, the Company reserves the right to alter specifications.

Hotpoint Ltd, Peterborough, PE2 9JB, England

Printed in England

# HOTPOINT COMPACT MICROWAVE OVEN USER HANDBOOK MODEL 6610

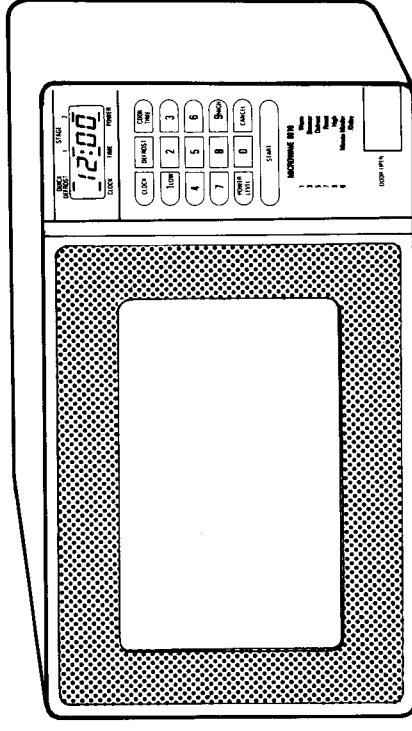

# Hotpoint®

## CONTENTS

Introduction	3
Specifications	3-4
Installation Instructions	5-6
Important Safety Instructions	7-11
Know Your Compact Microwave Oven	12-15
Understanding the Ovens Cooking Features	15
How to Set the Oven Controls	
<i>Setting the 12 hour clock</i>	16
<i>Quick defrosting</i>	17
<i>Cooking in one stage</i>	18
<i>Cooking in two stages</i>	19-21
<i>Quick defrosting and cooking in two stages</i>	21-23
<i>Minute minder</i>	24-25
<i>Delayed cooking</i>	25-26
Cleaning and Maintenance	27
Cooking Utensils	28
Cooking Techniques	29-30
Questions and Answers	31
Before Calling for Service	32
Hotpoint Service Cover	33
Hotpoint Service Offices	back cover

## INTRODUCTION

This instruction book has been carefully designed to help you get the most out of your new microwave oven. You will find that it will take you a little time to become familiar with the functions and facilities which your oven offers you. By taking the time to read these instructions and by following them carefully you will learn more quickly, and make fewer mistakes than if you try to manage without reading them.

### **What the instruction book is designed to do**

The purpose of this instruction book is to show you what your oven can do. It will help you to understand the control panel and all the functions of the oven. It takes you through all the different things you can do in easy steps.

As well as this instruction book, you have also been given a cookery book specially designed to accompany your oven. However, all the information you will need to get started with your new oven is included in this instruction book. The basic cooking information is complemented by more detailed recipes in the cookery book and the two books are designed to be used together.

Your new oven has been labelled in accordance with the new MAFF labelling scheme. The label is located on the oven door, and it informs you of the power output in watts (700W) and the heating category (C). Most packaged food suitable for microwaving will be marked with these symbols. After heating always check that the food is piping hot throughout.

**Before you do anything with your oven, including putting a plug on it, please read the Important Safety Instructions on pages 7 to 11. This is for your own safety and to make sure you don't damage your new oven.**

## SPECIFICATIONS

AC Line Voltage:  
Single phase 240V, 50Hz

AC Power Required:  
1150W

Output Power:  
700 W (IEC 705)



Microwave Frequency:  
2450MHz

Outside Dimensions:  
462mm (W) x 309mm (H) x 349mm (D)

Cavity Dimensions:  
300mm (W) x 202mm (H) x 298mm (D)

Oven Capacity:  
18 litres

Cooking Uniformity:  
Turntable system (ø 275mm)

Weight:  
Approx. 16kg

As a part of our policy of continuous improvement, we reserve the right to alter design and specification without notice.

## SPECIFICATIONS

- Simple touch control.
- Variable power selection controls power output from 120W to 700W.
- 3-stage programmable cooking for automatically changing from one stage to the other at the programmed time.
- Smart control panel with flat membrane electronic touch-control keys.
- Tone signal sounds when a key is touched to confirm operation.
- Electronic digital clock with accurate 99 minutes 99 seconds timer in each stage.
- Automatic quick defrosting function provided.
- Delay start cooking available up to 99 minutes 99 seconds.
- Small 18 litres cooking cavity for family-size meals.
- Painted steel cavity for easy to clean.
- Automatic oven light and see through door window allow monitoring of the cooking process.
- Detailed cookbook.
- "E" display when the door is opened during oven operation.

## HOTPOINT SERVICE COVER

### Satisfaction Guaranteed or Your Money Back

Hotpoint gives you a unique 'Satisfaction Guaranteed' promise – valid for ninety days after you have purchased your Hotpoint appliance product. If there is a problem with your Hotpoint appliance just call your Hotpoint Service Office. If necessary we will arrange for an engineer to call. If the problem is not resolved by us under this Guarantee, Hotpoint will replace your appliance or, if you prefer, give you your money back. This Guarantee is additional and subject to the terms of Hotpoint's Five Year Parts Guarantee.

### Hotpoint's Free Five Year Guarantee

From the moment your appliance is delivered, Hotpoint guarantees it for **FIVE YEARS**.

- In the Five Years all replacement parts are **FREE** provided they are fitted by our own Service Engineer. During the first year our Engineer's time and labour is also free. Our Guarantee also covers loss of food in our Refrigeration and Freezer products up to £250 during the first year. After the first year we will charge for our Engineer's time and labour. We do, however, operate a range of Service Plans (see opposite) which for an annual payment enables you to cover any repair costs which may be necessary.
- All our service repairs are guaranteed for twelve months in respect of our labour and any parts fitted.
- The appliance must be used in the United Kingdom and must not be tampered with or taken apart by anyone other than our own Service Engineer.
- Our Guarantee does not cover the cost of any repair which is needed because of power cuts, accidents or misuse. Nor does it cover the cost of any visit to advise you on the use of the appliance. Please read the instruction book thoroughly.
- If at any time during the Guarantee period we are unable to repair your appliance, we will refund any repair costs paid to us in the previous twelve months. We will also offer you a new appliance at a reduced charge instead of a repair.
- Our Guarantee is in addition to and does not affect your legal rights.
- Should you need independent advice on your consumer rights, help is available from your Consumer Advice Centre, Law Centre, Trading Standards Department and Citizens Advice Bureau.
- All Hotpoint servicing is done by our own Service Organisation located throughout the United Kingdom and Southern Ireland. It will be happy to deal with any problems.

### Hotpoint's Service Care

Whether you have just one or a number of Hotpoint appliances in your kitchen Hotpoint has a range of Service Schemes to give you complete peace of mind.

#### Service Cover

One annual payment covers you for all repairs for **Individual appliances**. Service Cover also covers loss of food up to the value of £250 in our refrigeration and freezer products. If two or more appliances are covered a 20% reduction is made on each fee. There is also the option of **Service Cover with Maintenance** at an additional cost. Service Schemes are renewable each year by mutual agreement.

#### Kitchen Cover

One annual payment covers you for all Repairs and a Maintenance Check for **all Hotpoint appliances owned** which are less than ten years old. Kitchen Cover also covers loss of food up to the value of £250 in our refrigeration and freezer products. Any additional Hotpoint appliances purchased after you have joined **Hotpoint Kitchen Cover** will automatically be included during the current annual period of cover without any further charge.

#### Appliance Registration

To ensure that you have the opportunity to benefit from any of the above Service Schemes you should complete and return immediately the Appliance Registration Form supplied with your your appliance. Full details and costs of our Service Schemes together with an application form will be sent to you at the end of the first year of the guarantee.

#### Annual Safety/Maintenance Checks

Hotpoint strongly recommends that all its appliances are regularly checked for electrical and mechanical safety whether or not they are covered by a Service Plan.

#### Proof of Purchase

For future reference please attach your purchase receipt to this booklet and keep it in a safe place.

#### Spare and Accessories

Spare parts and accessories can be ordered from your local Hotpoint Spares Centre (listed on the back page), using the order form enclosed.

## BEFORE CALLING FOR SERVICE

Refer to following checklist, you may prevent an unnecessary service call.

### The oven doesn't work

1. Check that the power cord is securely plugged in.
2. Check that the door is firmly closed.
3. Check that the cooking time is set.
4. Check for a blown circuit fuse or tripped main circuit breaker in your house.

### Sparking in the cavity

1. Check that utensils are not metal containers or dishes with metal trim.
2. Check that metal skewers do not touch the interior walls.

If there is still a problem, notify the closest Spares Centre (listed on the back page).

**DO NOT ATTEMPT TO SERVICE THE OVEN YOURSELF!**

## INSTALLATION INSTRUCTIONS

### HOW TO EXAMINE YOUR MICROWAVE OVEN AFTER UNPACKING

1. Take all of the packing material from inside the oven and remove all the protective film and labels from the oven door.
2. Check the oven for any damage. If you notice any damage please do not use it, contact your dealer.

### WHERE TO PLACE YOUR MICROWAVE OVEN

Place the oven on a flat and level surface, strong enough to take the weight, plus the heaviest item likely to be cooked.

### IMPORTANT NOTE:

- Take care when lifting the oven, it is heavy.
- The oven must not be located in areas where heat and moisture are generated and not near to easily combustible materials (e.g. curtains).
- Do not install the oven in a humid place, where it could damage the oven.
- Do not store or use the oven outdoors.

### ELECTRICAL CONNECTION

**WARNING — THIS APPLIANCE MUST BE EARTHED.**

**REFER TO RATING PLATE FOR VOLTAGE AND CHECK THAT THE APPLIANCE VOLTAGE CORRESPONDS WITH THE SUPPLY VOLTAGE.**

**Applicable only if the moulded plug is removed or a plug is not supplied**

The flexible mains lead must be correctly connected, as below, to a three pin plug of not less than 13amp capacity. You must use a 3 pin plug which should be marked with the number BS1363 and it should be fitted with a BROWN coloured 13 amp fuse marked with the number BS1362.

We recommend the use of good quality plugs and wall sockets that can be switched off when the machine is not in use.

**IMPORTANT:** The wires in the mains lead fitted to this appliance are coloured in accordance with the following code:

GREEN AND YELLOW	—	EARTH
BLUE	—	NEUTRAL
BROWN	—	LIVE

As the colours of the wires in the mains lead of this appliance may not correspond with the coloured markings identifying the terminals in your plug, proceed as follows:—

The wire which is coloured green and yellow must be connected to the terminal in the plug which is marked with the letter E or by the earth symbol  $\equiv$  or coloured green or green and yellow.

The wire which is coloured blue must be connected to the terminal which is marked with the letter N coloured black, or blue.

The wire which is coloured brown must be connected to the terminal which is marked with the letter L or coloured red, or brown.

When wiring the plug, ensure that all strands of wire are securely retained in each terminal. Do not forget to tighten the mains lead sheath clamp. Like most appliances in your house, your oven must be connected to a single phase 240 Volt 50Hz alternating current supply. If your electricity supply point has only two pin socket outlets, or if you are in doubt, consult a qualified electrician.

If you do not make the proper electrical connections you will damage your microwave oven and possibly injure yourself. Neither the manufacturer nor the supplier are liable if this happens.

### MOULDED PLUGS (when fitted)

Should it be necessary to remove a moulded on plug from the mains cable, it should be cut off and replaced with a suitable replacement. The moulded plug cannot be used for any other appliance, therefore remove the fuse and dispose immediately and safely to prevent anyone, especially children from plugging it in to a wall socket, which will create a safety hazard.

Should the mains lead ever require replacement, it is essential that this operation be carried out by a qualified electrician and should only be replaced with a flexible cord obtained from the manufacturer.

**Applicable only if a moulded plug is fitted**  
After replacement of a fuse in the plug, the fuse cover must be refitted. If the fuse cover is lost, the plug must not be used until a replacement cover is obtained. The colour of the correct replacement fuse cover is that of the coloured insert in the base of the plug or the colour that is embossed in words in the

## INSTALLATION INSTRUCTIONS

base of the plug recess or elsewhere on the plug. Always state this colour when ordering a replacement fuse cover.

Only 13amp replacement fuses which are ASTA approved to BS 1362 should be fitted.

- The socket must be readily accessible to allow easy removal of the plug in an emergency.
- When removing the plug from the wall socket, always grip the plug and never pull out by the mains lead as this will damage the mains lead and the connections inside the plug.
- Make sure that the power supply cord is undamaged, and that it does not run under the oven or over any hot surfaces or sharp edges.
- Do not immerse power supply cord or plug, in water.
- Do insert the plug into the socket completely, otherwise the plug may become overheated and catch fire.
- Do not connect another appliance to the same socket using an adaptor as it may cause the house wiring to become overheated and may catch fire.
- If the plug or socket is loose or if the power supply cord is damaged, do not operate the oven and contact your dealer or an authorised service agent. The defective plug, power supply cord or socket may become hot and catch fire during operation or cause electrical shock.

## QUESTIONS AND ANSWERS

**Q: I accidentally ran my microwave oven without any food in it. Is it damaged?**

**A:** We do not recommend operating the microwave oven without any food. However, running the oven empty for a short time will not damage the oven.

**Q: Can I open the door when the oven is operating?**

**A:** The door can be opened anytime during the cooking operation. Microwave energy will be instantly switched off and the time setting will maintain until the door is closed.

**Q: Can the oven be used with the glass tray or roller guide removed?**

**A:** No. Both the glass tray and roller guide must be positioned correctly in the oven before cooking.

**Q: My microwave oven causes interference with my TV. Is this normal?**

**A:** Some radio and TV interference might occur when you cook with the microwave oven. This interference is similar to the interference caused by small appliances such as mixers, vacuums, blow dryers, etc. It does not indicate a problem with your oven.

**Q: How can we know whether the Microwave is generated or not?**

**A:** Microwave is generated only when the door is closed and a programme has been selected.

**Q: Why does my oven light dim?**

**A:** When cooking with a power other than HIGH, the oven must cycle to obtain the lower power levels. The oven light, dims and clicking noises can be heard when the oven cycles.

**Q: When I turn on my oven, there is noise coming from the glass tray.**

**A:** This noise occurs when the roller guide and oven bottoms are dirty. Frequent cleaning of these parts should eliminate or reduce the noise.

**Q: Why does steam accumulate on the oven door?**

**A:** During cooking, steam is given off from the food. Most of the steam is removed from the oven by the air which circulates in the oven cavity.

However, some steam will condense on cooler surfaces such as the oven door. This is normal.

**Q: Sometimes warm air comes from the oven vents. Why?**

**A:** The heat given off from the cooking food warms the air in the oven cavity. This warmed air is carried out of the oven by the air flow pattern in the oven. There are no microwaves in the air. The oven vents should never be blocked during cooking.

**Q: Does microwave energy pass through the viewing screen in the door?**

**A:** No. The metal screen bounces back the energy to the oven cavity. The holes are made to allow light to pass through. They do not let microwave energy pass through.

**Microwave cooking techniques**

You also need to know the important techniques for microwave cooking. The important techniques of the food are:

**Quality of the Food**

1. As microwaves will cook quickly, when roasting meat, better cuts should be used.
2. More economical cuts are recommended to be cooked by casseroles, stewing, pot roasting.
3. Vegetables and fish should be as fresh as possible to obtain best results.

**The starting temperature**

1. Cold food takes longer to cook than food at room temperature.
2. Recipes assume that food has been stored at its normal storage temperature e.g. fish and chicken from a fridge, vegetables and soup at room temperature.



**The density**

1. Dense or solid foods e.g. whole potatoes will take longer to cook than less dense foods e.g. fresh peas.

**The composition**

1. Food with high fat or sugar content will heat more quickly than food with a lower content.
2. Take care when you reheat mince pies and Christmas pudding which are both high in sugar and fat.

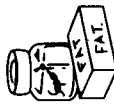

**Size and Shape**

1. This affects the overall cooking times.
2. When cooking more than one of a particular food e.g. jacket potatoes — choose items of the same size so they cook evenly.
3. If different sized items are cooked together uneven cooking will occur.

**The arrangement**

1. Arrange food so that the thickest part is towards the outside of the dish.
2. A good example is chicken drumsticks where the thinner bony ends won't require as much cooking as the thicker ends.



- Covering**
1. Certain types of food benefit from being covered during microwave cooking.
  2. Covering will prevent splashing and help foods cook evenly.
  3. Use a lid or microwave plastic wrap.

**Piercing**

1. Always pierce foods which have a skin or membrane. These include: eggs, potatoes, tomatoes, apples, sausages, aubergines.
2. If you don't pierce them, steam will build up inside and they may explode.



**Stirring and turning**

1. Always either stir or turn food during cooking wherever possible, for example, casseroles so that the hot food on the outside is mixed with the cooler food.
2. Turn joints of meat or poultry over halfway through their cooking time to ensure even cooking.



**Standing time**

This is an essential part of the cooking process to ensure food is completely cooked. This standing time allows the heat to spread evenly through the food. All food needs to stand and the amount of standing time you should allow is usually given in the recipe.



Food defrosted in the microwave oven must also be left to stand.

**GENERAL** — It is recommended that the microwave oven is attended during the cooking stages. Exceeding the cooking time and too high a power level leads to overheating of food, which may burn and cause a risk of fire.

**WARNING** — To avoid fire, damage to your oven, burns, electric shock or injury:

**To avoid fire**

1. **Attendance**  
It is recommended that the microwave oven is attended during the cooking operations.
2. **Times and power**  
Follow the instructions in the attached cookery book supplied. Exceeding the specified cooking times and/or the incorrect programming of a microwave power setting could result in overheating of the item of food, and in extreme circumstances the risk of burning your food and damage to the oven. Care should be taken when cooking or heating foods with a high sugar or fat content, such as Christmas pudding, mince pies and fruit cakes.

**3. Risk of fire**

In the case of overheating the item of food if the food smokes or burns (because of overheating), the following procedure must be carried out.

1. Keep the oven door closed.
2. Turn the oven off and disconnect the plug from the socket. If you don't follow these instructions, food may catch fire and damage the oven.

**4. Disposable containers**

Use only microwave suitable materials. Do not leave the oven in unattended operation when food is heated or cooked in disposable containers of plastic, paper or other combustible materials, see page 28.

**5. Ventilation**

1. Do not block or obstruct the air vent openings.
2. Do not put anything near the air vent openings that may be ignited easily by the hot air coming out of them.

**6. Roasting bags**

Plastic and wire twist ties should not be used within the oven as they may melt or catch fire due to an electrical discharge.

**7. Paper products**

Do not use newspaper or re-cycled paper inside the oven, as these may contain materials that could get hot and cause a fire.

**8. Oil and fat**

Never heat oil or fat. You cannot control the temperature of them so they may overheat and catch fire.

**9. Popcorn**

Unless you have a special microwave popcorn popper never cook popcorn in your oven as it can be dangerous and the results are disappointing. Don't use oil unless the manufacturer recommends the use of it and never heat for longer than stated.

**10. Bottle fruit**

Do not try to bottle fruit in your microwave oven as it requires prolonged high temperatures to do so properly.

**11. Storing foods**

Do not keep food or anything inside the oven when it is not being used except in case of the AUTO START cooking conditions.

**12. Food splash shield**

After each use wipe the splash shield cover on the ceiling of the oven with a soft damp cloth to remove any splashes. If you leave grease on the shield it might overheat next time the microwave is used and start to smoke or even catch fire.

**13. Turntable and walls**

Always wipe up spills and splashes on the turntable and inner oven cavity after cooking. If you leave grease on the turntable it might overheat next time the oven is used and start to smoke or even catch fire.

**14. Check**

Please check the setting after you start the oven, to ensure the oven is operating as desired. Exceeding the cooking time or using too high a power level, leads to overheating of food which may burn and could cause a risk of fire.

## IMPORTANT SAFETY INSTRUCTIONS

### To avoid damage to your oven

1. **Visual check**  
Check the oven carefully for any signs of damage. Pay particular attention to:
  - a) The door, make sure the door closes properly and make sure it is not misaligned or warped.
  - b) The hinges and safety door latches, check and make sure they are not broken or loose.
  - c) The door seals and seal surfaces, make sure that they have not been damaged.
  - d) Inside the oven cavity or on the door, check to be certain that there are no dents or damaged surfaces.

**If there is any damage, please do not operate the oven. Contact your dealer or an authorised service agent, because the damaged oven may cause leakage of microwaves.**

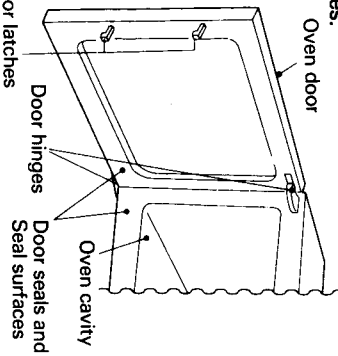

**It is dangerous for this oven to be adjusted or repaired by anyone except a properly qualified service technician trained by the manufacturer.**

### 2. Door

- a) Do not attempt to operate the oven with the door open. It is important not to deface or tamper with the safety door latches as it could result in exposure to microwave energy with the door open.
- b) Do not operate the oven with any object caught in the door seal between the oven front face and the oven door as this may cause microwaves to leak out.
- c) Never allow grease or dirt to build up on the door seal and sealing surfaces as this may stop the door working correctly and may cause microwaves to leak out. Wipe the seals and door regularly with a damp cloth, preferably before splashes and grease become dried on to the surface.

### To avoid electric shock

1. **Outer cabinet**  
Never remove the outer cabinet, it is very dangerous because there are some high voltage parts inside which can be fatal if touched.

### 2. Holes

Do not insert fingers or objects in the holes of the door latches or air vent openings. It may cause an electric shock or damage the oven.

### To avoid explosion and sudden boiling

#### 1. Lids

Always remove the lids of jars and containers and take away food containers, before you microwave them. If you don't, then steam and pressure might build up inside and cause an explosion even after the microwave cooking has stopped.

#### 2. Liquids

**Warning: When heating liquids, e.g. soups, sauces and beverages in your microwave oven, overheating the liquid beyond boiling point can occur without the evidence of bubbling. This could result in a sudden "boil over" of the hot liquid.**  
To help prevent this happening, the following steps should be followed:

1. Avoid straight sided containers with narrow tops or necks.
2. Do not overheat.
3. Stir the liquid before placing the container in oven and again halfway through the heating time.
4. After heating, allow to stand in the oven for a short time, stir again before carefully removing the container.

#### 3. Eggs

**Never cook eggs in their shells. Steam will build up inside the shell during cooking and the egg will explode. If you want to cook or reheat eggs which have not been broken up by scrambling or mixing, you must always pierce the yolks or these will also explode. You should slice shelled hard boiled eggs before you reheat them in your microwave oven.**

#### 4) Piercing

Always pierce food which has a skin or membrane, for example, potatoes, tomatoes, apples, sausages etc. If you don't pierce them, steam will build up inside and they may explode.

## MICROWAVE COOKING TECHNIQUES

### The Background to Cooking by microwaves

#### How microwaves cook and heat food

1. Microwaves are absorbed by the water, sugar and fat which are in the food. The microwaves make the individual particles vibrate very quickly causing the food to heat up by friction, in the same way that your hands get warm when you rub them together. Most parts of the food are heated by microwaves directly as mentioned above. And the rest of it is heated by conduction of heat from hot food next to it. This is why it is very important that you turn food around, rearrange or stir it so that hot and cooler parts are mixed together for even cooking. You must allow the food to stand (the standing time), otherwise some parts may be cool and slightly undercooked and other parts may be very hot.  
Standing guide, see page 30.











2. Microwaves can pass straight through dishes and utensils which are non-metallic and can then heat the food inside the container. Information about the best type of dishes to use is given on page 28.
3. Microwaves are reflected by metal, which is why the oven is lined with metal and there is a fine metal mesh in the door. This will make sure that there is no danger of the microwaves leaking out.



## MICROWAVE COOKING UTENSILS

### Microwave cooking utensils

You can use a variety of cookware in your microwave oven as long as it allows microwaves to pass through into the food. You should try and choose round or oval dishes rather than square or oblong ones. It is very easy to overcook food in the corners of square dishes if they are not shielded during microwave cooking and defrosting.

Utensil	Use	Advice
 Ovenproof glass	YES	Ideal for cooking, reheating and defrosting.
 Plastic microwave cookware	YES	Ideal for cooking, reheating and defrosting.
 Microwave plastic wrap Microwave bags Roasting bags	YES	You should always pierce the bags or wraps to let the steam out. <b>Do not use metal ties to fasten the bags.</b>
 China and ceramics	YES/NO	<b>Most</b> ovenproof china and ceramic dishes are suitable, as long as they do not have any gold or silver decoration. These metallic decorations will cause the microwaves to arc (flash). This may cause damage to both your oven and your china. Do not use antique dishes.
 Thin plastic, straw and wood	YES	Only suitable for warming food in. Straw and wood are not high temperature resistant material, therefore excessive over heating of these materials may cause a fire in your microwave oven.
 Kitchen paper towel (not re-cycled)	YES	Only suitable for warming food in. Can also be crumpled up and used to absorb fat and splashes when you cook bacon. Paper is not high temperature resistant material, therefore excessive over heating of this material may cause a fire in your microwave oven.
 Metal bakeware	NO	Reflects microwaves so cannot pass into the food and may cause arcing.
 Foil and foil container	YES/NO	You can use small pieces of foil to stop overheating of parts of foods you are cooking. But you should not use large pieces of foil, as microwaves are reflected by metal and they must not touch the walls of the oven to avoid arcing. Preferably take food out of foil trays and place in a microwave proof dish. Where microwaveable covering or no lid fitted, always remember to stir the product immediately it is defrosted and halfway through the heating cycle. <b>Foil board lids must not be used and must always be removed before heating in microwave oven.</b> <b>Do not place any empty foil container in a microwave oven.</b> If the microwave oven has been used to reheat a product for more than 15 minutes, allow the glass turntable to cool before using again. Care should be exercised when removing any lid or covering from heated food, as hot steam may escape.

NOTE: If you are not sure if a dish is suitable to use, ask the dish manufacturer.

## IMPORTANT SAFETY INSTRUCTIONS

- Do not heat baby foods/feeds in a microwave oven. The container may feel cool but the contents could be scalding hot.
- Oven gloves**  
Always use dry, good quality oven gloves to prevent burns when handling utensils that are in contact with hot food. Enough heat from the food can transfer through utensils to cause skin burns.
- Face and hands**  
Avoid steam burns by directing steam away from the face and hands. Slowly lift the farthest edge of a dish's covering and carefully open popcorn and oven cooking bags away from the face.
- Standing back**  
Always stand back when opening the oven door to allow any build-up of heat or steam to disperse. Keep the door closed when the oven is not in use to prevent accidents.
- Foods with filling**  
Cut baked foods with filling after heating to release steam and avoid burns from their jam and liquid contents.
- Temperature**  
**Always** test the temperature of food or drink which has been heated in a microwave oven before you give it to somebody, especially to children or elderly people. This is important because things which have been heated in a microwave oven carry on getting hotter even though the microwave cooking has stopped.
- The temperature of the outside of the container is not a good indication of the temperature of the food or drink inside, so you must test the temperature of the actual contents.
- To test that the food is cooked fully, insert a meat thermometer in the thickest or densest area, away from areas such as fat and bone. Never leave the thermometer in food during cooking, unless it is approved for microwave oven use.
- Standing time** (see page 30)  
Always allow standing time after microwave cooking/defrosting. Standing time is part of the microwave cooking process – it is **not** an optional extra. If you do not leave microwaved food to stand for the time stated in the recipe, there is a chance that it will not be properly cooked.
- Turn over, rearrange and stir**  
It is important to turn or rearrange food, and if possible stir it during microwave cooking. If you don't do this, some parts of it may be undercooked or not properly defrosted.
- Bacteria**  
Select, store, and handle food carefully to preserve its high quality and minimise the spread of foodborne bacteria.
- Cook chilled food**  
When reheating Cook Chilled Food, ensure the food is piping hot and if in doubt, extend the heating time declared by the Food Manufacturer.
- Sterilising**  
Do not sterilise baby feeding bottles in microwave ovens, as air bubbles can get trapped, causing incomplete sterilisation. Sterilising solution should not be heated in a microwave oven.
- It is essential to wash meat, poultry products and the cooking utensil before cooking immediately after defrosting.
- It is vitally important to strictly adhere to the basic principles of food handling and hygiene to prevent the possibility of bacterial growth.

### Guidelines to destroying harmful bacteria

- Check to see if the food is thoroughly cooked. Look for the following signs indicating that cooking temperatures have been reached and food is cooked.
  - Food steams throughout, not just at edge.
  - Centre bottom of dish is very hot to touch.
  - Poultry and thigh joints move easily, poultry juices shows no pinkness.
  - Fish is opaque and flakes easily with a fork.

## IMPORTANT SAFETY INSTRUCTIONS

### To avoid misuse by children

1. Children should not be allowed to operate or remove items from the oven.
2. **Leaning or swinging**  
Do not allow anyone to lean or swing on the oven door. And do not allow anyone to play with the oven.

### Other warnings

1. **Repair**  
It is very dangerous for anyone other than a service technician trained by the manufacturer, to perform a repair or service of the oven.  
**Never** adjust or repair the oven by yourself, or never allow anyone who is not a trained service technician to do so.
2. **Modification**  
**Never** attempt to modify the oven in any way.
3. **Working**  
Do not operate the oven if it is not working properly.
4. **Moving**  
**Never** attempt to move the oven while it is operating.
5. **Purpose**  
Only use the microwave oven for cooking/thawing or heating of food. This product is not suitable for any other use.
6. **Domestic use**  
Please note, that the microwave oven is designed for domestic use. The oven is not suitable for commercial, industrial or laboratory use.  
The manufacturer declines any liability for damages caused by improper use.
7. **Keep clean**  
Please clean your microwave oven regularly and remove any stains or fat residues without delay. Failure to do this may affect the quality and safety of the product or prejudice your guarantee.
8. **Plastic wrap**  
Plastic wrap that is specially marked for microwave use can be used for cooking and heating. It is recommended that the plastic wrap does not touch food because it may melt. Vent plastic wrap so steam can escape.
9. **Installation**  
**Never** install the oven at a height where a hazard could be created when removing hot food and liquids.
- 10

### CAUTION — To reduce the possibility of trouble with the oven or damaging it:

1. **Ventilation**
  - a) Do not block the air vent openings of the oven.
  - b) When water or food drops into the inside of the oven through the air vent openings, stop the oven immediately, unplug it and call for the service agent.
2. **Empty oven**  
**Never** use the microwave function with an empty oven as it will damage the oven.
3. **Checking utensils**  
Before you use any dishes or utensils for microwave cooking you must check that they are suitable. Instructions on what kind of dishes and utensils are suitable are found on page 28.
4. **Browning dish**  
Should you wish to use a browning dish, we would suggest that a heat proof plate be placed between turntable and browning dish in order to prevent the glass turntable and roller guide from damage by heat stress. It is important that the recommended preheating time of the dish should not be exceeded.
5. **Self heating material**  
Do not place self heating materials directly onto the turntable (see browning dish above).
6. **Metal**  
Metal utensils should NOT be used for MICROWAVE cooking. Metal reflects microwave energy and may cause an electrical discharge known as arcing.
  - If metal (such as aluminium foil) is used for a special purpose, it must never come into contact with the oven walls during operation, because they may get damaged. **The distance to the oven walls must be kept to at least 2cm.**
7. **Canned food**  
Never heat cans of food in the microwave oven, (see Metal above).
8. **Turntable**  
For all operations, the roller guide should be correctly installed on the coupling and the turntable should be correctly placed upon it. If you do not do so, the turntable may not turn or may rattle, as a result it may damage the oven. If you operate the oven without the above accessories, the food will not be heated thoroughly.

## CLEANING AND MAINTENANCE

### Cleaning

Switch **Off** and remove plug from socket. It is easier to clean the microwave oven than a conventional cooker as oven surfaces are flat and cool. The daily cleaning procedure is as follows:  
Make sure the oven is turned off before cleaning any part.

### Interior

1. Do not allow grease, soil and spatter to build up. A build up of grease or food particles on the oven interior can result in damage to the oven as well as loss of cooking power.
2. Use only a mild detergent, water and a soft cloth to clean the door surface and interior. **DO NOT** use scouring pads, powder or other abrasive materials.
3. To loosen stubborn food particles, place a measuring cup filled with water on the turntable. Operate the oven until the water boils, the steam will loosen any stubborn particles.
4. Odours can be eliminated from the inside of the oven by boiling a solution of one cup of water and several tablespoons of lemon juice in the oven for 5-7 minutes.
5. Ensure that the oven door seal and front rim of the oven are kept clean and free from soil.
6. Wipe excess moisture from the inside of the oven, including the door and door seal, **AFTER EACH USE.**  
**Note:** The moisture on the inside of your microwave oven is normal, and nothing to worry about. It is caused by the steam from the cooking food coming into contact with the cool oven surface.

### Never Pour Water into the Oven

As a safety measure, frequently wipe the door sealing surface.  
The turntable is removable. To clean spills, remove and wash in sink or dishwasher. Periodic cleaning under the turntable may be required.

Never try to rapidly cool the turntable (or other cookware) in water while it is still hot. If the turntable is used successively for a long time, it will be heated up to a high temperature. Never dip it into cold water or wipe with a cold dish cloth. Such rapid cooling will possibly cause the turntable to crack or break.

### Exterior

The outer cabinet is painted. Clean with a cloth or sponge, moistened in a mild detergent solution, and then dry with a clean cloth. Avoid spilling water into the vents. Do not use Petroleum spirit, thinners or any kind of chemical solvent to clean the outer cabinet. The control panel and trim are best wiped with a damp cloth, and then wiped immediately with a dry cloth. The door window's outer panel is plastic. Use a damp cloth to wipe clean. Do not use Petroleum spirit, thinners or any kind of chemical solvent to clean the oven door or control panel. **Do not use scouring pads, or abrasive powder.**

### Storage

If you must store your microwave oven, choose a dry, dust-free place. Dust and dampness can affect the oven's working parts.

DO THIS...

POWER

4. Touch POWER.

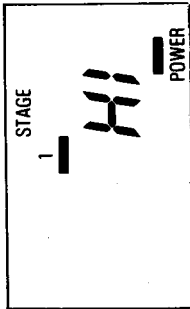

The POWER Indicator Light will be lit and the Display will show "HI".

THIS HAPPENS...

0

5. Touch "0" Number Pad.

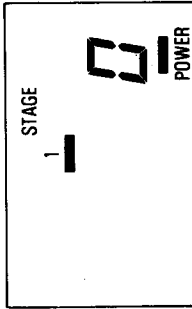

The Display will show "0". This shows the oven will not be operating and no power level has been selected.

TIME

6. Touch TIME again.

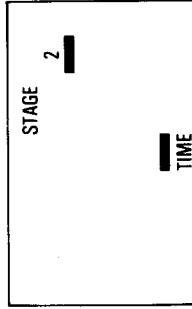

Both STAGE 2 and TIME Indicator Lights will be lit and the Display will show a colon.

7. Set required power level and time.

START

8. Touch START.

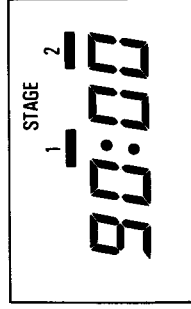

The Indicator Lights and Display will show the same information as "Cooking in two stages" during operation. During the first stage, the oven will be off but the Display will count down the set delay time.

Count Down

BEEP  
BEEP  
BEEP

**NOTE:** If the interior light is lit when you touch START, the timer has not been set properly. Touch CLEAR. Repeat above steps.

The maximum delay time is 99 minutes, 99 seconds.

**8. Turntable** (continued)

Do not place food heavier than 10 lbs (5kg) as the turntable motor could become damaged.

**9. Disposal**

At the end of the microwave's life, it must be disposed of safely to avoid further use. To make it safe, snap off the door latches, and remove the mains cable. This will prevent the door latching shut and the oven from being powered up.

**NOTE — Information you need to know.**

- 1. Guarantee claim (see guarantee card)**  
In the unlikely event of this equipment requiring repair during the guarantee period, you will need to provide proof of date of purchase to the repairing company. Please keep your invoice or receipt, which is supplied at the time of purchase.
- 2. Turntable**  
The turntable will rotate in either direction. The rotary direction of the turntable may change every time you start the oven. The direction of rotation of the turntable does not affect the performance of the oven.
- 3. Oven light**  
The oven light comes on when food is being cooked and goes off on opening the oven door.
- 4. Rack**  
When defrosting and/or cooking meat, we recommend the use of a microwave proof roasting rack and dish. This will help to prevent spillage of the juices into the cavity.
- 5. Steam**  
Sometimes food with a high moisture content may give off a lot of steam during cooking. This is quite normal.
- 6. Microwave oven wattage**  
Due to the adoption of the IEC 705 power rating you may find that when following old cook book timings (which have not been rated to IEC 705) they may require adjustment. Either increase or decrease the cooking time according to the condition of the food.
- 7. Door seal**  
The door seal stops microwaves from leaking out of the oven during cooking, but it does not form an airtight seal. This means that you may sometimes see drops of water, light, or feel warm air coming out from around the door. This is quite normal and does not mean that the oven is allowing microwaves to leak out.
- 8. Operation of key pads**  
The key pads will only operate once the oven door is closed.

## KNOW YOUR COMPACT MICROWAVE OVEN

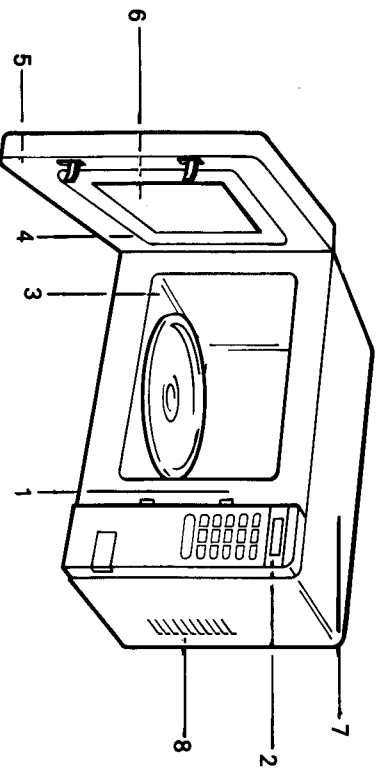
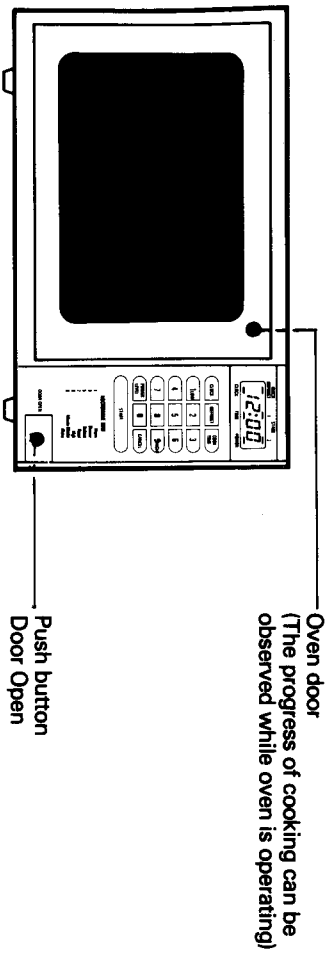

1. **Safety interlock system.**
2. **Digital Display** – Time of day clock, programmed cooking time and power levels shown here.
3. **Oven cavity.**
4. **Door Seal** – Door seal keeps the microwaves within the oven cavity and prevents microwave leakage.
5. **Safety door latches** – When door is closed, it will automatically lock up. If door is opened while oven is operating, magnetron will immediately stop operating.
6. **Door Screen** – Allows viewing of food. The screen is designed so that light can pass through, but not the microwave.
7. **Cabinet.**
8. **Air vents.**

## MINUTE MINDER

DO THIS . . .

THIS HAPPENS . . .

START

5. Touch START.

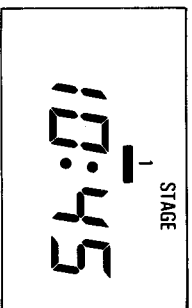

Count Down  
BEEP  
BEEP  
BEEP

The POWER Indicator Light will go off. The Display counts down to show remaining time. The oven interior light will not come on. When the set time ends, you will hear 3 beeps and the Display will show the time of day. If you did not set the clock, the Display will show a colon.

If interior light is lit when you touch START, the timer has not been set properly. Touch CLEAR and repeat above steps.

The count down may be interrupted by opening the oven door. Close the door and touch START to continue the timing count down.

*Stage 2 can be also used as a minute minder.*

## DELAYED COOKING

The microwave oven can be programmed to start automatically.

Use STAGE 1 at "O" Power to delay the start of STAGE 2 for up to 99 minutes, 99 seconds.

DO THIS . . .

THIS HAPPENS . . .

1. Place the food in the oven and close the door.

TIME

2. Touch TIME once.

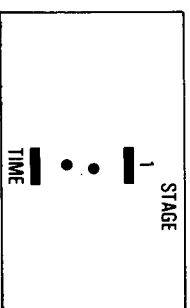

Both STAGE 1 and TIME Indicator Lights will be lit and the Display will show a colon.

9 0 0 0

3. Touch Number Pads for the required delay.

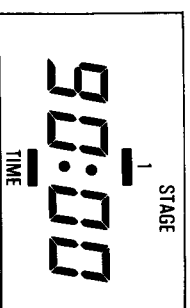

The Display will show the set delay time. e.g. 90 minutes, (1 hour, 30 minutes).

## MINUTE MINDER

The microwave oven controls can be used as a kitchen timer. Use stage 1 at "0" power for timing up to 99 minutes, 99 seconds.

### DO THIS... THIS HAPPENS...

TIME

1. Touch TIME once.

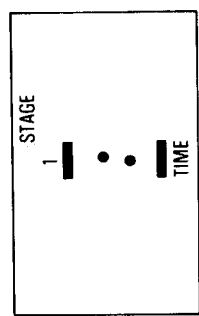

Both STAGE 1 and TIME Indicator Lights will be lit and the Display will show a colon.

1 0 4 5

2. Touch Number Pads for the minutes and seconds required.

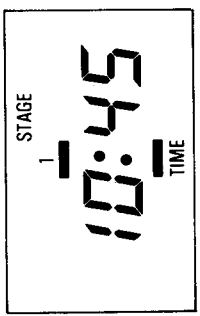

The Display will show the numbers. e.g. 10 minutes, 45 seconds.

POWER

3. Touch POWER.

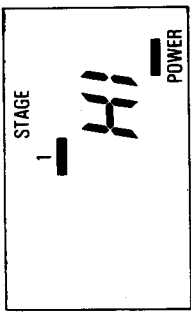

The POWER Indicator Light will be lit and the Display will show "HI".

0

4. Touch "0" Number Pad.

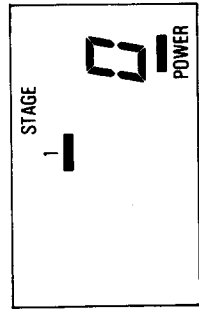

The Display will show "0". This shows that the oven will not be operating and no power level has been selected.

## CONTROL PANEL

Easy to set electronic display panel, which is fully programmable for cooking flexibility.

There are three parts in the control section:

- The Digital Display/Clock
- Function Pads
- Touch Number Pads

When the oven is plugged in and switched on a bleep sounds and the Display will show a colon.

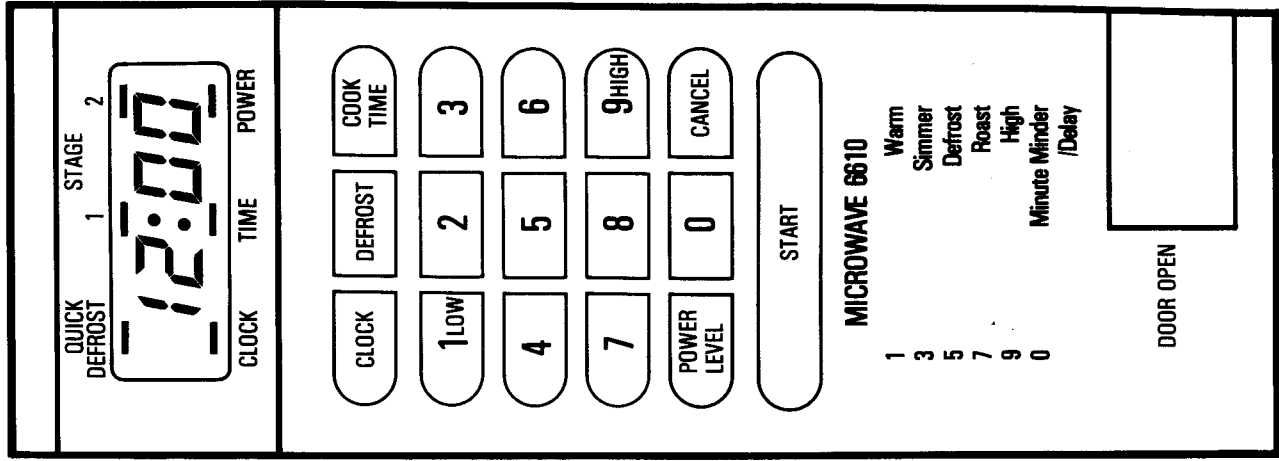

## DIGITAL DISPLAY/CLOCK AND INDICATOR LIGHTS

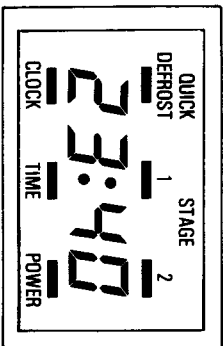

The Display will show time of day, power levels, selected programmes and time.

### FUNCTION PADS

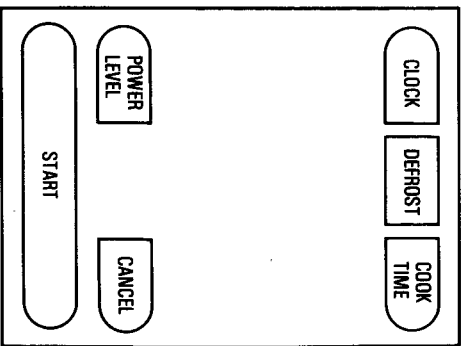

Touch function Pads for microwave programmes.

- A few examples:
- CLOCK to allow the clock to be set.
  - START to allow selected programmes to begin.

When a programme function is selected, an Indicator Light will be lit.

### NUMBER PADS

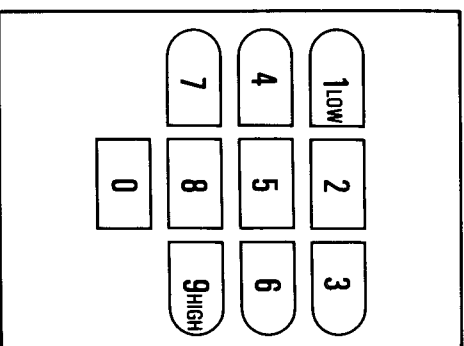

After the desired programme has been set, touch the Number Pad to select the required power and time.

## QUICK DEFROSTING AND COOKING IN TWO STAGES

DO THIS...

THIS HAPPENS...

11. Touch a Number Pad for the Power required in the second stage.

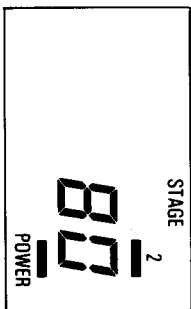

The Display will show the set power level.  
e.g. 80% of full power.

12. Touch START.

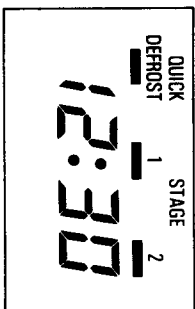
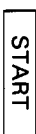

When you touch START, the Indicator Lights of QUICK DEFROST, STAGE 1 and 2 come on simultaneously to show you that oven is cooking in the Quick Defrosting.  
The POWER Indicator Light will go off. The oven will automatically defrost at 50% of full power. The Display will count down to show Quick Defrosting time remaining.  
When the Quick Defrosting ends, you will hear a beep and the oven will automatically start cooking in the first stage.

Count Down  
BEEP

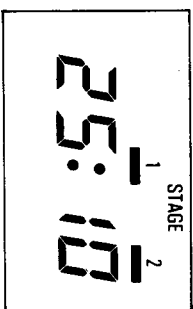

Count Down  
BEEP

The QUICK DEFROST Indicator Light will go off and both STAGE 1 and STAGE 2 Indicator Lights will remain lit. The oven will remain lit.  
The oven will cook at the Power level selected.  
The Display will count down to show remaining time in the first stage.  
When the first stage ends, you will hear a beep and the oven will automatically start cooking in the second stage.

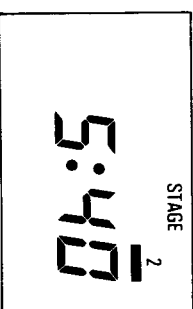

Count Down  
BEEP  
BEEP  
BEEP

The STAGE 1 Indicator Light will go off and the STAGE 2 Indicator Light will remain lit. The oven will cook at the Power level selected. The Display will count down to show remaining time in the second stage. When the second stage ends, you will hear 3 beeps. At the end of the cooking time, the Display will show the time of day. If the clock has not been set, the Display will show a colon.

## QUICK DEFROSTING AND COOKING IN TWO STAGES

### THIS HAPPENS...

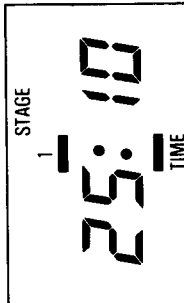
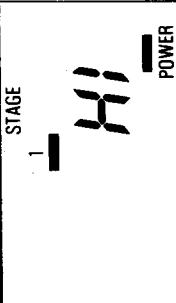
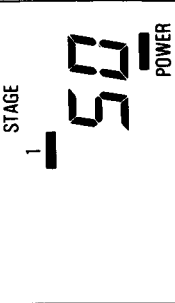
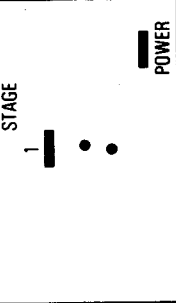
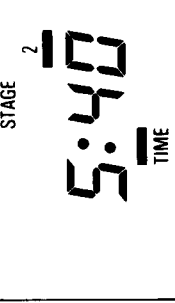
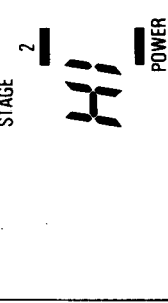
<p><b>DO THIS...</b></p> <p>2 5 1 0</p> <p>5. Touch Number Pads for the cooking time required in the first stage.</p>	<p>The Display will show the set cooking time. e.g. 25 minutes, 10 seconds.</p> 
<p><b>POWER</b></p> <p>6. Touch POWER. (Go to step 8 if high power is required).</p>	<p>The POWER Indicator Light will be lit and the Display will show "HI".</p> 
<p>5</p> <p>7. Touch a Number Pad for the Power you require in the first stage.</p>	<p>The Display will show the set power level. e.g. 50% of full power.</p> 
<p><b>TIME</b></p> <p>8. Touch TIME again.</p>	<p>Both STAGE 2 and TIME Indicator Lights will be lit and the Display will show a colon.</p> 
<p>5 4 0</p> <p>9. Touch Number Pads for the cooking time required in the second stage.</p>	<p>The Display will show the set cooking time. e.g. 5 minutes, 40 seconds.</p> 
<p><b>POWER</b></p> <p>10. Touch POWER. (Go to step 12 if you want to cook at high power).</p>	<p>The POWER Indicator Light will be lit and the Display will show "HI".</p> 

Number Pads when used to select Power represent the following:

Number Pads	Display	Wattage
0	0	0
1 LOW	10	120
2	20	194
3	30	266
4	40	337
5	50	411
6	60	483
7	70	555
8	80	628
9 HIGH	HI	700

When following recipes from cookbooks it is important to check the wattage against the power levels above.

### TO CLEAR DISPLAY

- Touch CANCEL to delete programme.
- Opening the oven door during cooking will not delete cooking instructions.

### PROGRAMMING BEEP

- Each time you touch a pad you will hear a beep.
  - If a beep is not heard, it is because the instructions programmed are not correct.
- Example:** If you touch a Number Pad without touching the TIME or DEFROST Pad first, a beep will not be heard.

### TO STOP THE OVEN WHILE IT IS OPERATING

- Open the door.
- You can restart it by closing the door and touching START.

## UNDERSTANDING THE OVEN'S COOKING FEATURES

This is the method you will most often use.

This oven allows you to set in a desired cooking time up to 99 minutes and 99 seconds. When cooking by TIME, you may also choose to use any of the 9 power levels.

### Cooking by TIME

Experimentation with microwave cooking shows that some foods cook better if the power level is changed during cooking. With this oven all of the necessary cooking instructions can be programmed into the oven at once, thus eliminating the need to return to the oven before cooking is completed. Please refer to "Cooking in two stages".

### Programme Cooking

## HOW TO SET THE OVEN CONTROLS

### SETTING THE 12 HOUR CLOCK

When the oven is first plugged in and switched on the Display will show a colon and a beep sounds.  
If the supply is interrupted, the Display will show a colon when the power comes back on.  
You can cook without setting the clock, but the Display will show a colon after the cooking is completed.

DO THIS...

THIS HAPPENS...

1. Touch **CLOCK**.

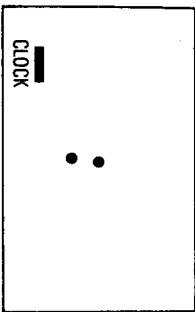

The **CLOCK** Indicator Light will be lit and the Display will show a colon.

2. Touch Number Pads for the correct time of day.



The Display will show the set time of day.  
This example shows 10:10

3. Touch **START**.

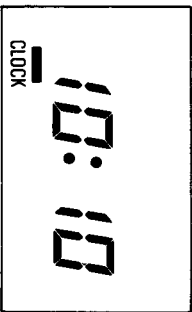

If you've touched in an incorrect time such as 13:24, the Display will show a colon and you will hear a beep.  
Reset the clock.  
This digital clock allows you to set from 1:00 to 12:59.

### COOKING IN TWO STAGES

DO THIS...

THIS HAPPENS...

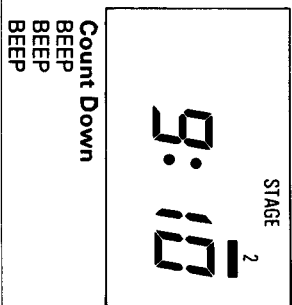

Count Down  
BEEP  
BEEP  
BEEP

The **STAGE 1** Indicator Light will go off and the **STAGE 2** Indicator Light will remain lit.  
The Display will show time remaining in the second stage.  
When the **STAGE 2** ends, you will hear 3 beeps.  
At end of the cooking time, the Display will show the time of day.  
If the clock has not been set, the Display will show a colon.

### QUICK DEFROSTING AND COOKING IN TWO STAGES

For best results, some recipes call for two power levels to be used during cooking. The microwave oven can be programmed to allow this option.

DO THIS...

THIS HAPPENS...

1. Place the food in the oven and close the door.

**QUICK DEFROST**

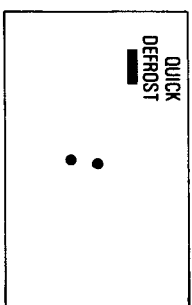

The **QUICK DEFROST** Indicator Light will be lit and the Display will show a colon.

2. Touch **QUICK DEFROST**.

**1 2 3 0**

3. Touch Number Pads for the cooking time required.



The Display will show the set cooking time.  
e.g. 12 minutes 30 seconds.

4. Touch **TIME**.

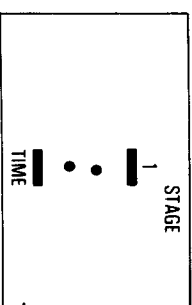

Both **STAGE 1** and **TIME** Indicator Lights will be lit and the Display will show a colon.



## COOKING IN TWO STAGES

DO THIS ...

9 1 0

- Touch Number Pads for the cooking time required in the second stage.

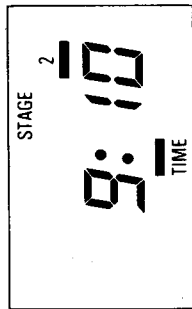

The Display will show the set cooking time.  
e.g. 9 minutes 10 seconds.

POWER

- Touch POWER. (Go to step 10 if high power is required).

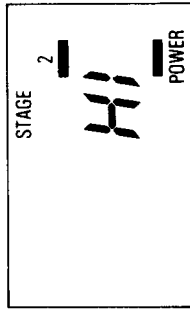

The POWER Indicator Light will be lit and the Display will show "HI".

8

- Touch a Number Pad for the Power level required in the second stage.

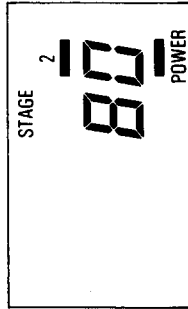

The Display will show the set power level  
e.g. 80% of full power.

START

- Touch START.

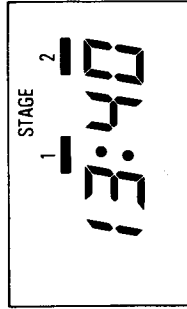

The POWER Indicator Light will go off.  
The oven will cook in the Power at the programmed level.  
The Display will count down the time to show cooking time remaining in the first stage.  
At the end of the first stage, you will hear a beep and the oven will automatically start cooking in the second stage.

Count Down  
BEEP

## QUICK DEFROSTING

The oven door can be opened any time during the cooking operation, the oven will automatically stop cooking and the Display will show "E" until the door is closed.

DO THIS ...

- Place the food in the oven and close the door.

QUICK DEFROST

- Touch QUICK DEFROST.

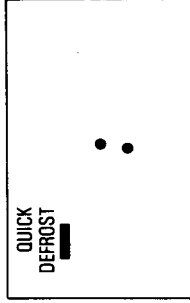

The QUICK DEFROST Indicator Light will be lit and the Display will show a colon.

2

7

1

0

- Touch Number Pads for the cooking time required.

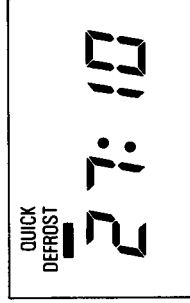

This example shows 27 minutes 10 seconds.  
The Display will show the set cooking time.

START

- Touch START.

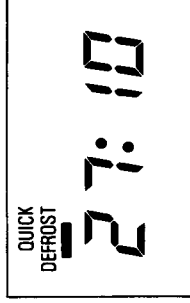

The oven will automatically defrost at 50% of full power.  
When you touch START, QUICK DEFROST Indicator Light will stay on to show the oven is cooking in the Quick Defrosting.  
The Display counts down to show you how much cooking time is remaining.  
When the cooking time ends, you will hear 3 beeps.  
At the end of cooking time, the Display will show the time of day.  
If the clock has not been set, the Display will show a colon.

Count Down

BEEP  
BEEP  
BEEP

## COOKING IN ONE STAGE

DO THIS...

THIS HAPPENS...

- Place the food in the oven and close the door.

TIME

- Touch TIME once.

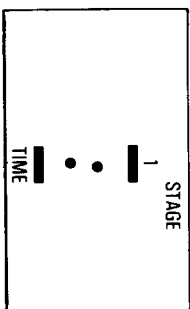

Both STAGE 1 and TIME Indicator Lights will be lit and the Display will show a colon.

1 2 3 0

- Touch Number Pads for the cooking time required.

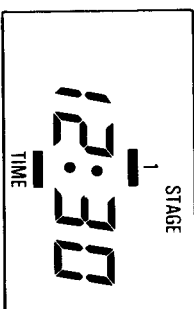

The Display will show the set cooking time.  
e.g. 12 minutes 30 seconds.

POWER

- Touch POWER. (Go to step 6 if high power is required).

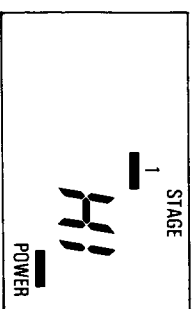

The POWER Indicator Light will be lit and the Display will show "HI".

3

- Touch a Number Pad for the Power required.

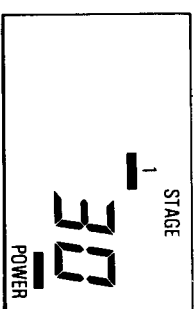

The Display will show the set power level  
e.g. 30% of full power.

START

- Touch START.

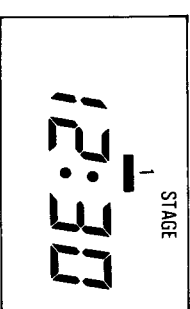

Count Down  
BEEP  
BEEP  
BEEP

The POWER Indicator Light will go off. The oven will cook at the Programmed Power level. The Display counts down the time to show remaining cooking time. When the cooking time ends, you will hear 3 beeps. At end of cooking time the Display will show the time of day. If the clock has not been set, the Display will show a colon.

## COOKING IN TWO STAGES

DO THIS...

THIS HAPPENS...

- Place the food in the oven and close the door.

TIME

- Touch TIME once.

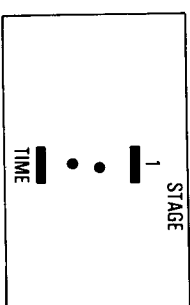

Both STAGE 1 and TIME Indicator Lights will be lit and the Display will show a colon.

1 3 4 0

- Touch Number Pads for the cooking time required in the first stage.

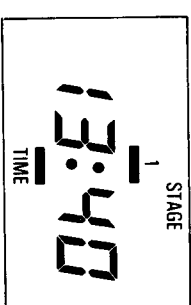

The Display will show the set cooking time.  
e.g. 13 minutes 40 seconds.

POWER

- Touch POWER. (Go to step 6 if high power is required).

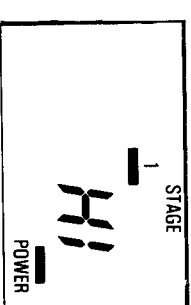

The POWER Indicator Light will be lit and the Display will show "HI".

3

- Touch a Number Pad for the Power required in the first stage.

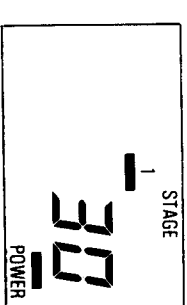

The Display will show the set power level  
e.g. 30% of full power.

TIME

- Touch TIME again for second stage cooking.

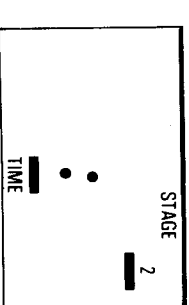

Both STAGE 2 and TIME Indicator Lights will be lit and the Display will show a colon.