

Amana[®]

**Over-The-Range
Microwave Oven
Owner's Manual,
Cooking Guide, &
Installation Instructions**

**MVH250E
MVH250W
MVH250L**

Attention:

Keep these instructions for future reference.
If microwave oven changes ownership, be sure
this manual accompanies microwave oven.

Table Of Contents

TABLE OF CONTENTS	2	Auto Cook	15
		Cooking Guide for Auto Cook	16
SAFETY	3	Auto Reheat	17
Precautions To Avoid Possible Exposure To		Cooking Guide for Auto Reheat	17
Excessive Microwave Energy.....	3	Auto Defrost.....	18
Important Safety Instructions.....	4,5	Defrosting Tips.....	18
		Auto Defrost Chart	19
INFORMATION	6	Time Defrost	21
Location of Model Number.....	6	Two Position Metal Rack	21
Model Identification.....	6	COOKING	22
Parts and Accessories	6	Getting the Best Cooking Results	22
Service	6	Fish & Shellfish	22
Asure™ Extended Service Plan.....	6	Appetizers/Sauces/Soups	23
Electrical Requirements	6	Meat	23
Grounding Instructions.....	6	Poultry.....	25
Microwave Oven Features.....	7	Pasta And Rice	26
Oven Specifications	7	MAINTENANCE	27
Oven Control Panel.....	8	Care And Cleaning.....	27
OPERATION	10	Metal Rack	27
Learn About Your Microwave Oven	10	Cleaning the Grease Filters	27
Help.....	10	Charcoal Filter Replacement	27
Clock.....	10	Cooktop/Night Light Replacement	28
Kitchen Timer.....	10	Oven Light Replacement	28
Control Set-Up	10	MICROWAVE UTENSIL GUIDE	29
Vent Hi-Low-Off	11	BEFORE CALLING FOR SERVICE	30
Turntable On-Off.....	11	QUESTIONS AND ANSWERS	30
Child Lock	11	INSTALLATION	31
Light Hi-Low-Off.....	11	Your Safety First	31
Light Timer	11	Parts, Tools, Materials	34
Easy Cook™	12	Step 1 : Prepare the Electrical Connections	36
Hold Warm.....	12	Step 2 : Prepare the Venting System.....	37
Favorite Recipe.....	12	Step 3 : Prepare the Venting Blower.....	39
More/Less	12	Step 4 : Prepare the Wall and Upper Cabinet	
Cooking at High Cook Power.....	13	for Installation	41
Cooking at Lower Power Levels	13	Step 5 : Install the Mounting Plate	43
Cooking with More Than One Cook Cycle.....	13	Step 6 : Attach the Oven to the Wall.....	44
Cooking Guide for Lower Power Levels.....	14	WARRANTY	46
Popcorn.....	15		
Potato.....	15		
Pizza	15		
Beverage.....	15		

Safety

PRECAUTIONS TO AVOID POSSIBLE EXPOSURE TO EXCESSIVE MICROWAVE ENERGY...

- (a) Do not attempt to operate this oven with the door open since open-door operation can result in harmful exposure to microwave energy. It is important not to defeat or tamper with the safety interlocks.
- (b) Do not place any object between the oven front face and the door or allow soil or cleaner residue to accumulate on sealing surfaces.
- (c) Do not operate the oven if it is damaged. It is particularly important that the oven door closes properly and that there is no damage to the:
 - (1) Door (bent),
 - (2) Hinges and latches (broken or loosened),
 - (3) Door seals and sealing surfaces.
- (d) The oven should not be adjusted or repaired by anyone except properly qualified service personnel.

Safety

IMPORTANT SAFETY INSTRUCTIONS

The safety instructions below will tell you how to use your oven and avoid harm to yourself or damage to your oven.

WARNING

To reduce the risk of burns, electric shock, fire, injury to persons, or exposure to excessive microwave energy.

- **Read all the instructions before using your oven.**
- **Do not allow children to use this oven without close supervision.**
- Read and follow the specific **PRECAUTIONS TO AVOID POSSIBLE EXPOSURE TO EXCESSIVE MICROWAVE ENERGY** found on page 3.
- **Do not use** corrosive chemicals or vapors, such as sulfide and chloride, in this appliance. This type of oven is specifically designed to heat, cook, or dry food. It is not designed for industrial or laboratory use.
- **Do not use or store** this appliance outdoors. Do not use this product near water - for example, near a kitchen sink, in a wet basement, or near a swimming pool, and the like.
- **Do not use** the cavity for storage purposes. Do not leave paper products, cooking utensils, or food in the cavity when not in use.
- **Clean the ventilating hood frequently.** Do not allow grease to accumulate on the hood or the filters.
- Use care when cleaning the vent hood filters. Corrosive cleaning agents such as lye-based oven cleaners, may damage the filters.
- **Do not tamper with the built-in safety switches on the oven door.** The oven has several built-in safety switches to make sure the power is off when the door is open.
- When flaming foods under the hood, turn the fan on.
- Suitable for use above both gas and electric cooking equipment 36 inches wide or less.
- **Do not use this oven for commercial purposes.** It is made for household use only.
- **When cleaning the door and the surfaces that touch the door, use only mild, non-abrasive soaps or detergents and a sponge or soft cloth.**
- **If your oven is dropped or damaged,** have it thoroughly checked by a qualified service technician before using it again.
- **To avoid a fire hazard:**
 - **Do not overcook food.** Overcooked foods can start a fire in the oven. Watch the oven carefully, especially if you have paper, plastic, or other combustibles in the oven.
 - **Do not store combustible items (bread, cookies, etc.) in the oven.**
 - **Do not use wire twist-ties in the oven.** Be sure to inspect purchased items for wire twist-ties and remove them before placing the item in the oven.
- **If a fire should start:**
 - **Keep the oven door closed.**
 - **Turn the oven off.**
 - **Disconnect the power cord or shut off the power at the fuse or circuit breaker panel.**
- **To avoid electric shock:**
 - **This appliance must be grounded.** Connect it only to a properly grounded outlet. See the electrical **GROUNDING INSTRUCTIONS** on page 6.
 - **Do not operate this appliance if it has a damaged cord or plug,** if it is not working properly or if it has been damaged or dropped.
 - **Do not immerse the electrical cord or plug in water.**
 - **Keep the cord away from heated surfaces.**
 - **Do not use extension cord.**

Safety

- **To avoid improperly cooking some foods.**
 - **Do not heat any types of baby bottles or baby food.** Uneven heating may occur and possibly cause personal injury.
 - **Do not heat small-necked containers,** such as syrup bottles.
 - **Do not deep-fat fry in your microwave oven.**
 - **Do not attempt home canning in your microwave oven.**
 - **Do not heat the following items in the microwave oven:** whole eggs in the shell, water with oil or fat, sealed containers, or closed glass jars. These items may explode.
- Do not cover or block any openings in the oven.
- Use your oven only for the operations described in this manual.
- Do not run the oven empty, without food in it.
- Do not let cord hang over edge of table or counter.
- **Preserve the oven floor:**
 - **Do not heat the oven floor excessively.**
 - **Do not allow the gray film on special microwave-cooking packages to touch the oven floor.** Put the package on a microwavable dish.
 - **Do not cook anything directly on the oven floor or turntable.** Use a microwavable dish.
 - Keep a browning dish at least 3/16 inch above floor. Carefully read and follow the instructions for the browning dish. If you use a browning dish incorrectly, you could damage the oven floor.
- Install or locate this appliance only in accordance with the provided installation instructions.
- This appliance should be serviced only by qualified service personnel. Contact the nearest authorized service facility for examination, repair, or adjustment.

SAVE THESE INSTRUCTIONS

FEDERAL COMMUNICATIONS COMMISSION RADIO FREQUENCY INTERFERENCE STATEMENT (U.S.A. ONLY)

This equipment generates and uses ISM frequency energy and if not installed and used properly, that is in strict accordance with the manufacturer's instructions, may cause interference to radio and television reception. It has been type tested and found to comply with limits for ISM Equipment pursuant to part 18 of FCC Rules, which are designed to provide reasonable protection against such interference in a residential installation. However, there is no guarantee that interference will not occur in a particular installation. If this equipment does cause interference to radio or television reception, which can be determined by turning the equipment off and on, the user is encouraged to try to correct the interference by one or more of the following:

- Reorient the receiving antenna of the radio or television.
- Relocate the Microwave Oven with respect to the receiver.
- Move the microwave oven away from the receiver.
- Plug the microwave oven into a different outlet so that the microwave oven and the receiver are on different branch circuits.

The manufacturer is not responsible for any radio or TV interference caused by **unauthorized modification** to this microwave oven. It is the responsibility of the user to correct such interference.

Information

Please read this owner's manual. It will tell you how to use all the fine features of this microwave oven.

LOCATION OF MODEL NUMBER

To request service information or replacement parts, the service center will require the complete model number of your microwave oven. The number is on the oven front as shown in the illustration below.

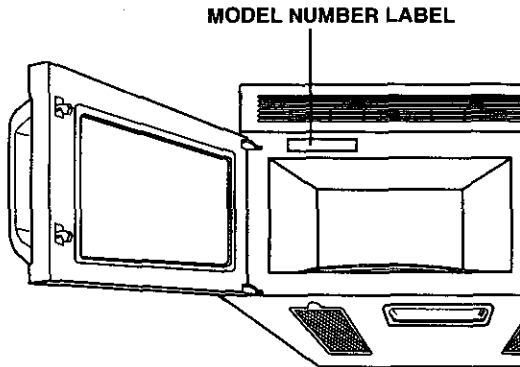

MODEL IDENTIFICATION

Complete enclosed registration card and promptly return. If registration card is missing, call Consumer Affairs Department at 1-800-843-0304 inside U.S.A. 1-319-622-5511 outside U.S.A. When contacting Amana, provide product information located on rating plate. Record the following:

Model Number : _____
Manufacturing Number : _____
Serial or S/N Number : _____
Date of purchase : _____
Dealer's name and address : _____

PARTS AND ACCESSORIES

Purchase replacement parts and additional accessories (e.g., refrigerator shelves, dryer racks, or cooktop modules) over the phone. To order accessories for your Amana product, call 1-800-843-0304 inside U.S.A. or 1-319-622-5511 outside U.S.A.

SERVICE

Keep a copy of sales receipt for future reference or in case warranty service is required. Any questions or to locate an authorized servicer, call 1-800-NAT-LSVC (1-800-628-5782) inside U.S.A. 1-319-622-5511 outside U.S.A. Warranty service must be performed by an authorized servicer. Amana, also recommends contacting an authorized service if service is required after warranty expires.

ASURE™ EXTENDED SERVICE PLAN

Amana offers long-term service protection for this new oven. Asure™ Extended Service Plan is specially designed to supplement Amana's strong warranty. This plan covers parts, labor, and travel charges. Call 1-800-528-2682 for information.

ELECTRICAL REQUIREMENTS

The oven is designed to operate on a Standard 120V/60Hz household outlet. Be sure the circuit is at least 15 or 20A and the microwave oven is the **only appliance on the circuit**. It is not designed for 50Hz or any circuit other than a 120V/60Hz circuit.

GROUNDING INSTRUCTIONS

This appliance must be grounded. If an electrical short circuit occurs, grounding reduces the risk of electric shock by providing an escape wire for the electric current. The cord for this appliance has a grounding wire with a grounding plug. Put the plug into an outlet that is properly installed and grounded. Do not use extension cord.

WARNING

If you use the grounding plug improperly, you risk electric shock.

Ask a qualified electrician if you do not understand the grounding instructions or if you wonder whether the appliance is properly grounded.

Because this appliance fits under the cabinet, it has a short power-supply cord. See the Installation Instructions for directions on placing the cord properly. Keep the electrical power cord dry and do not pinch or crush it in any way.

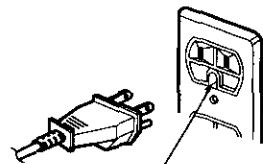

Ensure proper ground exists before use

Information

MICROWAVE OVEN FEATURES

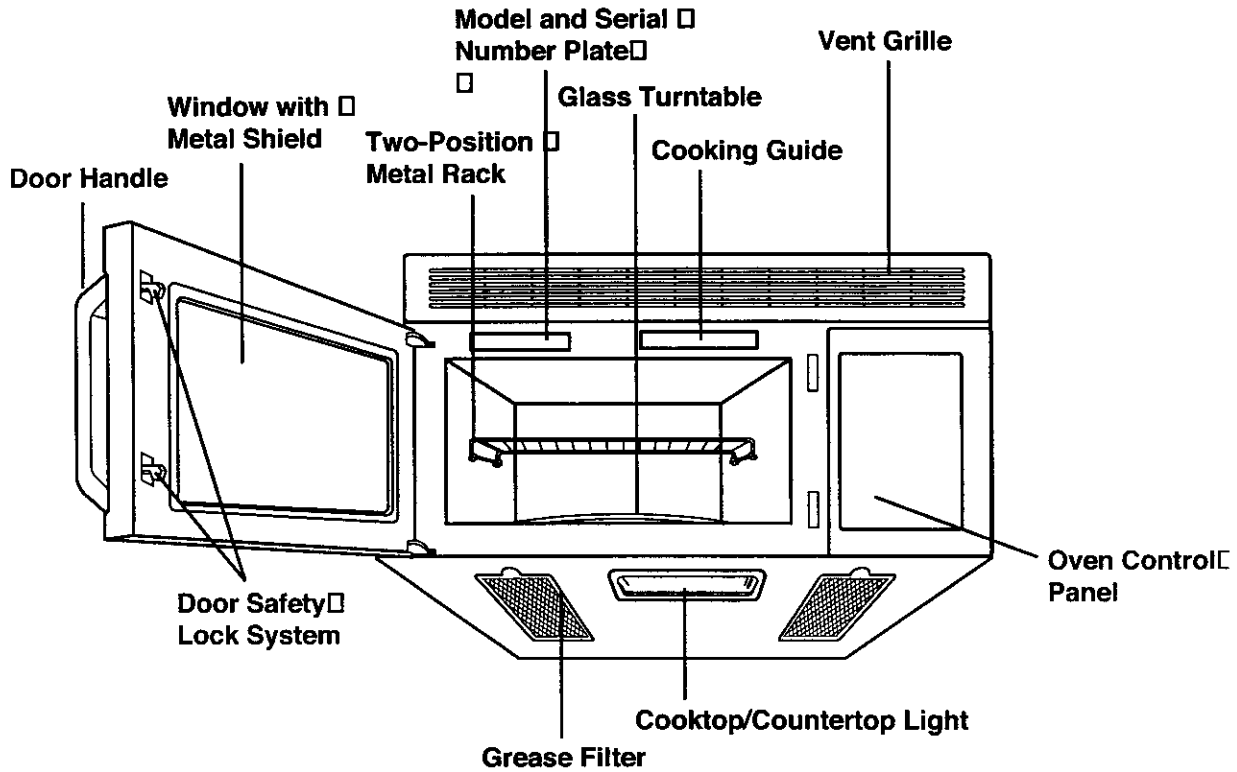

OVEN SPECIFICATIONS

Power Supply	120 VAC, 60 Hz
Input Power	1,500 W
Cooking Power	1,000 W (IEC705 Standard)
Frequency	2,450 MHz
Rated Current	14 A
Outer Dimensions	29-15/16" x 16-7/16" x 15-3/8"
Cavity Volume	1.5 Cu. Ft
Net Weight	65 lbs

Information

OVEN CONTROL PANEL

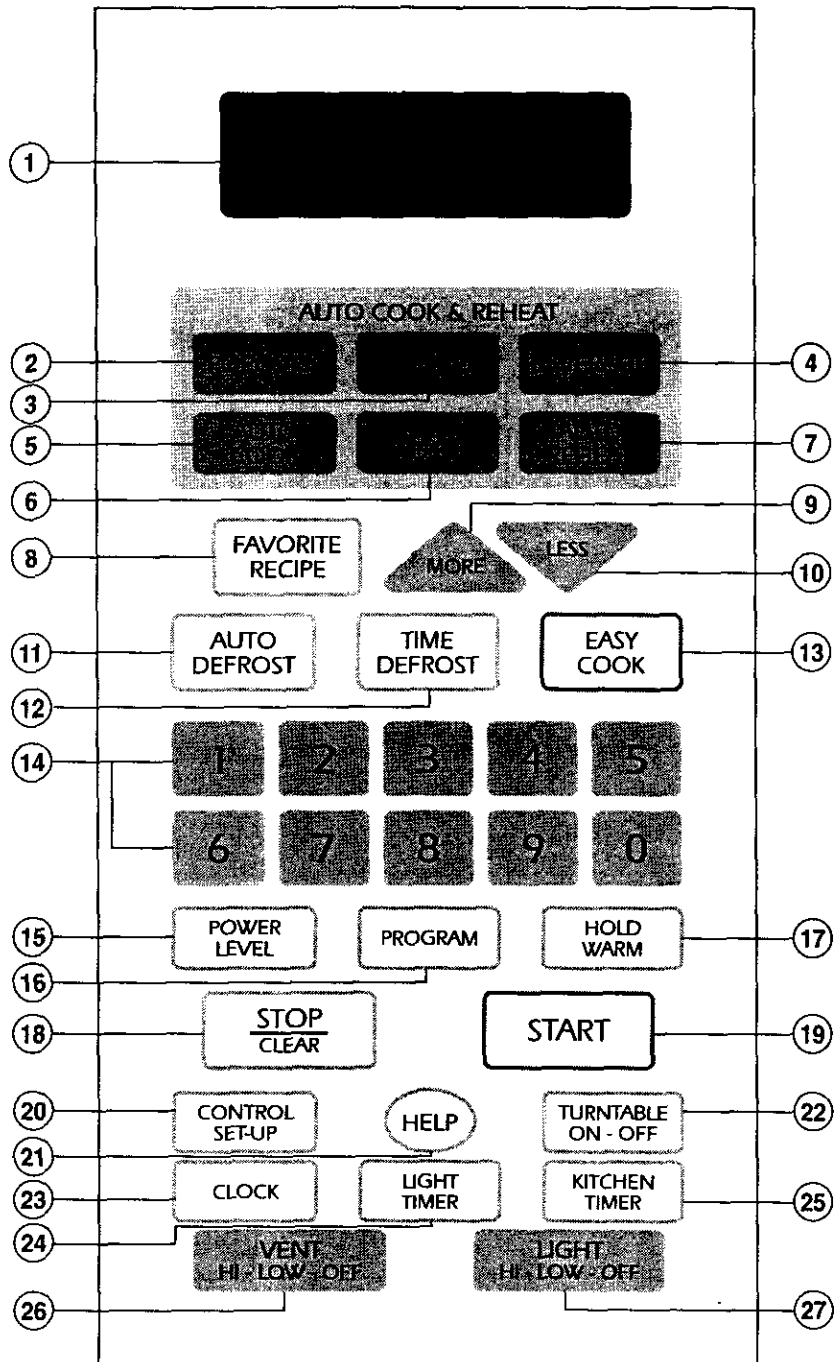

Information

- 1. DISPLAY:** The display includes a clock and indicators to tell you time of day, cooking time settings, and cooking functions selected.
- 2. POPCORN:** Touch this pad when popping popcorn in your microwave oven. See page 15 for more information.
- 3. POTATO:** Touch this pad to cook from 1 to 4 potatoes. See page 15 for more information.
- 4. BEVERAGE:** Touch this pad to reheat one or two cups of a beverage. See page 15 for more information.
- 5. AUTO COOK:** Touch this pad to cook vegetables, rice, casseroles. See page 15 for more information.
- 6. PIZZA:** Touch this pad to reheat 1 to 3 slices. See page 15 for more information.
- 7. AUTO REHEAT:** Touch this pad to reheat dinner plate, soup/sauce, casseroles, roll/muffin. See page 17 for more information.
- 8. FAVORITE RECIPE:** Touch this pad to recall one cooking instruction previously programmed into memory. See page 12 for more information.
- 9. MORE:** Touch this pad to add ten seconds of cooking time each time you press it. See page 12 for more information.
- 10. LESS:** Touch this pad to subtract ten seconds of cooking time each time you press it. See page 12 for more information.
- 11. AUTO DEFROST:** Meat, poultry, fish. Touch on pad to select food type and defrost food by weight. See page 18 for more information.
- 12. TIME DEFROST:** Touch this pad to defrost most other frozen foods. See page 21 for more information.
- 13. EASY COOK:** Touch this pad to set and start quickly at 100% power level. See page 12 for more information.
- 14. NUMBER:** Touch number pads to enter cooking time, power level, quantities, or weights.
- 15. POWER LEVEL:** Touch this pad to select a cooking power level.
- 16. PROGRAM:** Touch this pad to set a cooking time.
- 17. HOLD WARM:** Touch this pad to keep hot, cooked foods warm in your microwave oven for up to 99 minutes 99 seconds. See page 12 for more information.
- 18. STOP/CLEAR:** Touch this pad to stop the oven or to clear all entries.
- 19. START:** Touch this pad to start a function. If you open the door after oven begins to cook, START again.
- 20. CONTROL SET-UP:** Touch this pad to change the oven's default settings for sound, clock, display speed, defrost weight, and demo mode operations. See page 10 for more information.
- 21. HELP:** Touch this pad to learn how to use each oven function. See page 10 for more information.
- 22. TURNTABLE ON-OFF:** Touch this pad to turn off the turntable. OFF will appear in the display. See page 11 for more information.
- 23. CLOCK:** Touch this pad to enter the time of day. See page 10 for more information.
- 24. LIGHT TIMER:** Touch this pad to set the light timer. See page 11 for more information.
- 25. KITCHEN TIMER:** Touch this pad to set the kitchen timer. See page 10 for more information.
- 26. VENT HI-LOW-OFF:** Touch this pad to turn the fan on or off. See page 11 for more information.
- 27. LIGHT HI-LOW-OFF:** Touch this pad to turn on the cooktop/countertop light. See page 11 for more information.

Operation

LEARN ABOUT YOUR MICROWAVE OVEN

This section discusses the concepts behind microwave cooking and introduces you to the basics you need to know to operate your microwave oven. Please read this information before use.

CAUTION

DO NOT RUN THE OVEN EMPTY.

HELP

The HELP pad displays feature information and helpful hints. Press HELP, then select a key pad.

Example: To learn about POPCORN.



1. Touch **HELP** pad.



2. Touch **POPCORN** pad.

KITCHEN TIMER

You can use your microwave oven as a timer. Use the Timer for timing up to 99 minutes, 99 seconds.

Example: To time 3 minutes.



1. Touch **KITCHEN TIMER** pad.



2. Enter the time by using the number key pad.



3. Touch **START** pad.
When the time is over, you will hear seven beeps and **END** will display.

CLOCK

This oven includes a 24-hour clock.

Example: To set 8:00 AM.



1. Touch **CLOCK** pad.
(Press once for AM, twice for PM.)



2. Enter the time by using the number key pad.



3. Touch **CLOCK** pad.

CONTROL SET-UP

You can change the default values for beep sound, clock, display speed, defrost weight, and demo mode operations.

See following chart for more information.

NUMBER	FUNCTION	NUMBER	RESULT
1	Beep ON/OFF control	1	Sound ON
		2	Sound OFF
2	Clock display control	1	Clock ON
		2	Clock OFF
3	Display	1	Slow speed
		2	Normal speed
		3	Fast speed
4	Defrost weight mode select	1	Lbs.
		2	Kg.
5	Demo mode select	1	Demo ON
		2	Demo OFF

Example: To change defrost weight mode.
(from Lbs. to Kg.)



1. Touch **CONTROL SET-UP** pad.



2. Touch number 4 pad.



3. Touch number 2 pad.

Operation

VENT HI-LOW-OFF



The VENT moves steam and other vapors from the cooking surface. Touch VENT once for High fan speed, twice for Low fan speed, or three times to turn the fan off.

NOTE: If the temperature gets too hot around the microwave oven, the fan in the vent hood will automatically turn on at the LOW setting to cool the oven. It may stay on up to an hour to cool the oven. When this occurs, **You can not turn the vent fan off.**

TURNTABLE ON-OFF



For best cooking results, leave the turntable on. It can be turned off for large dishes. Press TURNTABLE ON-OFF to turn the turntable on or off.

NOTE:

- Sometimes the turntable can become hot to touch. Be careful touching the turntable during and after cooking.
- Do not run the oven empty.

CHILD LOCK

You may lock the control panel to prevent the microwave from being accidentally started or used by children.

The Child Lock feature is also useful when cleaning the control panel. Child Lock prevents accidental programming when wiping the control panel.

Example: To set the child lock.



1. Touch **STOP/CLEAR** pad.



2. Touch and hold **0** pad more than 4 seconds. **LOCKED** will appear in the display window with two beeps.

Example: To cancel the child lock.



1. Touch and hold **0** pad more than 4 seconds. **LOCKED** will disappear and you hear two beeps. At this time the oven is ready.

LIGHT HI-LOW-OFF



Touch **LIGHT** pad once for bright light, twice for night light, or three times to turn the light off.

LIGHT TIMER

You can set the LIGHT to turn on and off automatically at any time you want. The light comes on at the same time every day until reset.

Example: Turn on 2:00 AM, turn off 7:00 AM.



1. Touch **LIGHT TIMER** pad. (Press once for AM, twice for PM.)



2. Enter the time you want the LIGHT to turn on.



3. Touch **LIGHT TIMER** pad again. (Press once for AM, twice for PM.)



4. Enter the time you want the LIGHT to turn off.



5. Touch **START** pad.

NOTE: To reset that time to turn on and off the LIGHT, repeat steps 1 to 5.

Example: To cancel the LIGHT TIMER.



1. Touch **LIGHT TIMER** pad.



2. Touch **STOP/CLEAR** pad.

NOTE: If you want to cancel the LIGHT TIMER in operation, you should touch key.

Operation

EASY COOK™

A time-saving pad, this simplified control lets you quickly set and start microwave cooking without the need to touch **START** pad.

Example: To set EASY COOK™ for 2 minutes.



1. Touch **EASY COOK™** pad 4 times.
The oven begins cooking and display shows time counting down.

NOTE:

If you touch **EASY COOK™**, it will add 30 seconds up to 3 minutes; after 3 minutes, every touch will add 1 minute up to 99 min 59 seconds.

HOLD WARM

You can keep cooked food warm in your microwave oven for up to 99 minutes 99 seconds. You can use **HOLD WARM** by itself or to follow a cooking cycle automatically.

Example: To use the hold warm.



1. Touch **HOLD WARM** pad.



2. Touch **START** pad.

NOTES:

- **HOLD WARM** operates for up to 99 minutes 99 seconds.
- **Food cooked covered** should be covered during **HOLD WARM**.
- **Pastry items** (pies, turnovers, etc.) should be uncovered during **HOLD WARM**.
- **Complete meals** kept warm on a dinner plate could be covered during **HOLD WARM**.

To make **HOLD WARM** automatically follow another cycle:

- While you are programming the cooking instructions, touch **HOLD WARM** before touching **START**.
- When the last cooking cycle is over, you will hear two tones and "WARM" will appear in the oven display.
- You can set **HOLD WARM** to follow **AUTO DEFROST**, or multi-cycle cooking.

FAVORITE RECIPE

FAVORITE RECIPE lets you recall one cooking instruction previously placed in memory and begin cooking quickly.

Example: To cook for 2 minutes.



1. Touch **FAVORITE RECIPE** pad.



2. Enter the cook time.



3. Touch **START** pad.

Example: To recall the favorite recipe.



1. Touch **FAVORITE RECIPE** pad.



2. Touch **START** pad.
When the cook time is over, you will hear four beeps and **END** will display.

MORE/LESS

By using the **MORE** or **LESS** keys, all of the pre-programmed cook and time cook features can be adjusted to cook food for a longer or shorter time. Pressing **MORE** will add 10 seconds of cooking time each time you press it. Pressing **LESS** will subtract 10 seconds of cooking time each time you press it.

Example: To adjust the 1.75 oz **POPCORN** cooking time for a longer time.



1. Touch **POPCORN** pad.



2. Touch number 1 pad.



3. Touch **MORE** pad.

Operation

COOKING AT HIGH COOK POWER

Example: To cook food for 8 minutes 30 seconds.



1. Enter the cook time.



2. Touch **START** pad.
When the cook time is over,
you will hear four beeps and
END will display.

COOKING AT LOWER POWER LEVELS

HIGH power cooking does not always give you the best results with foods that need slower cooking, such as roasts, baked goods, or custards. Your oven has 10 power settings in addition to HIGH.

Example: To cook food for 7 minutes 30 seconds at 70% power.



1. Enter the cook time.



2. Touch **POWER LEVEL** pad.



3. Enter the power level.



4. Touch **START** pad.
When the cook time is over,
you will hear four beeps and
END will display.

COOKING WITH MORE THAN ONE COOK CYCLE

For best results, some recipes call for one Power Level for a certain length of time, and another Power Level for another length of time. Your oven can be set to change from one to another automatically, for up to three cycles if the first heating cycle is defrost or the last at 0% power.

Example: To cook food for 3 minutes at 100% power and then 70% power for 7 minutes 30 seconds.



1. Enter the first cook time.



2. Touch **PROGRAM** pad.



3. Enter the second cook time.



4. Touch **POWER LEVEL** pad.



5. Enter the power level.



6. Touch **START** pad.
When the cook time is over,
you will hear four beeps and
END will display.

Operation

COOKING GUIDE FOR LOWER POWER LEVELS

The 10 power levels in addition to HIGH allow you to choose the best power level for the food you are cooking. Below are listed all the power levels,

examples of foods best cooked at each level, and the amount of microwave power you are using.

POWER LEVEL	MICROWAVE OUTPUT	USE
10 HIGH	100%	<ul style="list-style-type: none"> • Boil water. • Cook ground beef. • Make candy. • Cook fresh fruits and vegetables. • Cook fish and poultry. • Preheat browning dish.
9	90%	<ul style="list-style-type: none"> • Reheat meat slices quickly. • Saute onions, celery, and green pepper.
8	80%	<ul style="list-style-type: none"> • All reheating. • Cook scrambled eggs.
7	70%	<ul style="list-style-type: none"> • Cook breads and cereal products. • Cook cheese dishes, veal. • Cook cakes, muffins, brownies, cupcakes.
6	60%	<ul style="list-style-type: none"> • Cook pasta.
5	50%	<ul style="list-style-type: none"> • Cook meats, whole poultry. • Cook custard. • Cook whole chicken, turkey, spare ribs, rib roast, sirloin roast.
4	40%	<ul style="list-style-type: none"> • Cook less tender cuts of meat. • Reheat frozen convenience foods.
3	30%	<ul style="list-style-type: none"> • Thawing meat, poultry, and seafood. • Cooking small quantities of food. • Finish cooking casserole, stew, and some sauces.
2	20%	<ul style="list-style-type: none"> • Soften butter and cream cheese. • Heating small amounts of food.
1	10%	<ul style="list-style-type: none"> • Soften ice cream. • Raise yeast dough.
0		<ul style="list-style-type: none"> • Standing time.

Operation

POPCORN

POPCORN lets you pop 1.75, 3.0, and 3.5 ounce bags of commercially packaged microwave popcorn. Pop only one package at a time. If you are using a microwave popcorn popper, follow manufacturer's instructions. To set your microwave oven correctly, follow this chart:

Bag Size-ounces	1.75	3.0	3.5
Touch NUMBER	1	2	3

Example: To pop a 3.0 oz. bag.



1. Touch **POPCORN** pad.



2. Touch number **2** pad.
When the cook time is over, you will hear four beeps and **END** will display.

POTATO

POTATO lets you cook potatoes with preset times and cook powers. You can choose from 1 to 4 potatoes.

NOTE:

- Cooking times are based on an average 8 ounce potato.
- Before baking, pierce potato with fork several times.
- After baking, let stand for 5 minutes.

Example: To cook 2 Potatoes.



1. Touch **POTATO** pad.



2. Touch number **2** pad.
When the cook time is over, you will hear four beeps and **END** will display.

PIZZA

PIZZA lets you reheat up to 3 slices pizza. A slice is based on a 5 ounce slice.

Example: To reheat 1 slice pizza.



1. Touch **PIZZA** pad.



2. Touch number **1** pad.
When the cook time is over, you will hear four beeps and **END** will display.

BEVERAGE

BEVERAGE lets you heat up to 2 beverages.

NOTE:

- Reheat times based on an 8 ounce cup.
- Beverage may be very hot; remove from oven with care.

Example: To reheat one 8 oz. beverage.



1. Touch **BEVERAGE** pad.



2. Touch number **1** pad.
When the cook time is over, you will hear four beeps and **END** will display.

AUTO COOK

AUTO COOK provides four preset categories for cooking.

Example: To cook 2 cups of Rice.



1. Touch **AUTO COOK** pad.



2. Choose food category.

Category	Touch pad number
Fresh vegetable	1
Frozen vegetable	2
Rice	3
Casserole	4



3. Enter quantity/servings.

Category	Number of cups
Fresh vegetable	1 - 4 cups
Frozen vegetable	1 - 4 cups
Rice	1 - 2 cups
Casserole	1 - 4 cups

When the cook time is over, you will hear four beeps and **END** will display.

Operation

COOKING GUIDE FOR AUTO COOK

CODE	CATEGORY	QUANTITY	DIRECTIONS
1	FRESH VEGETABLE	1 cup Vegetables and 2 tbsp water	Place in a microwavable bowl or casserole. Add water according to the quantity. Cover with plastic wrap and vent. Let stand 5 minutes.
		2 cups Vegetables and 1/4 cup of water	
		3 cups Vegetables and 1/3 cup of water	
		4 cups Vegetables and 1/2 cup of water	
2	FROZEN VEGETABLE	1 cup	Place in a microwavable bowl or casserole. Cover with plastic wrap and vent. Let stand 5 minutes.
		2 cups	
		3 cups	
		4 cups	
3	RICE	1 cup of long grain rice and 2 1/4 cups of water	In large microwavable casserole, combine water, rice, margarine and salt. Cover with microwavable lid or plastic wrap and vent. After cooking, let stand covered for 5 minutes.
		2 cups of long grain rice and 4 1/4 cups of water	
4	CASSEROLE	1 cup	Place in a microwavable bowl or casserole. Cover with plastic wrap and vent.
		2 cups	
		3 cups	
		4 cups	

Operation

AUTO REHEAT

AUTO REHEAT provides four preset categories for reheating.

Example: To reheat 2 servings of Dinner plate.

1. Touch **AUTO REHEAT** pad.

2. Choose food category.

Category	Touch pad number
Dinner plate	1
Soup/sauce	2
Casserole	3
Roll/Muffin	4

3. Enter quantity/servings.

Category	Number of cups/Items
Dinner plate	1 - 2 servings
Soup/sauce	1 - 4 cups
Casserole	1 - 4 cups
Roll/Muffin	1 - 4 pieces

When the cook time is over, you will hear four beeps and **END** will display.

COOKING GUIDE FOR AUTO REHEAT

CODE	CATEGORY	SERVING AMOUNT	DIRECTION
1	DINNER PLATE	1 serving	Place on a low plate. Cover with vented plastic wrap.
		2 servings	
2	SOUP/SAUCE	1 cup	Place in shallow microwavable casserole. Cover with vented plastic wrap.
		2 cups	
		3 cups	
		4 cups	
3	CASSEROLE	1 cup	Place in a microwavable bowl or casserole. Cover with plastic wrap.
		2 cups	
		3 cups	
		4 cups	
4	ROLL/MUFFIN	1 piece	Place on paper towel. Do not cover.
		2 pieces	
		3 pieces	
		4 pieces	

Operation

AUTO DEFROST



Your microwave oven is preset with three defrost sequences. Using AUTO DEFROST is the best way to defrost frozen foods. The Auto Defrost Sequence Table below provides some basic guidelines for using the three defrost sequences.

Example: To defrost 1.2 lbs. of ground beef.

 1. Touch **AUTO DEFROST** pad.

 2. Choose food category.

Category	Touch pad number
Meat	1
Poultry	2
Fish	3

  3. Enter the weight.

 4. Touch **START** pad.

NOTE: When you touch the START pad. The display changes to defrost time count down. The oven will beep during the DEFROST cycle. At beep, open the door and turn food over, separate or rearrange the food. Remove any portions that have thawed. The oven will not STOP during the beep unless the door is opened.

 5. Close the door and restart.

When the defrost time is over, you will hear four beeps and **END** will display.

NOTE: If you do not open the door, the display will resume the countdown.

WEIGHT CONVERSION CHART

To enter food weight in AUTO DEFROST, you must specify pounds and tenths of a pound. If the weight on the food package is in fractions of a pound, you can use the following chart to convert the weight to decimals.

EQUIVALENT OUNCE WEIGHT	NUMBER AFTER DECIMAL
1.6	.10
3.2	.20
4.0	.25 One-Quarter Pound
4.8	.30
6.4	.40
8.0	.50 One- Half Pound
9.6	.60
11.2	.70
12.0	.75 Three-Quarters Pound
12.8	.80
14.4	.90
16.0	1.00 One Pound

DEFROSTING TIPS

- **When using AUTO DEFROST**, the weight to be entered is the net weight in pounds and tenths of pounds (the weight of the food minus the container).
- **Use AUTO DEFROST only for raw food.** AUTO DEFROST gives best results when food to be thawed is a minimum of 0°F (taken directly from a true freezer). If food has been stored in a refrigerator-freezer that does not maintain a temperature of 5°F or below, always program a lower food weight (for a shorter defrosting time) to prevent cooking the food.
- **If the food is stored outside the freezer** for up to 20 minutes, enter a lower food weight.
- **The shape of the package** alters the defrosting time. Shallow rectangular packets defrost more quickly than a deep block.
- **Separate pieces** as they begin to defrost. Separated pieces defrost more easily.
- **You can use small pieces** of aluminum foil to shield foods like chicken wings, leg tips, and fish tails, but the foil must not touch the side of the oven. Foil causes arcing, which can damage the oven lining.
- **Shield areas of food** with small pieces of foil if they start to become warm.
- **For better results, a preset standing time** is included in the defrosting time.

Operation

AUTO DEFROST CHART

Meat setting

FOOD	SETTING	AT BEEP	SPECIAL INSTRUCTIONS
BEEF			Meat of irregular shape and large, fatty cuts of meat should have the narrow or fatty areas shielded with foil at the beginning of a defrost sequence.
Ground Beef, Bulk	MEAT	Remove thawed portions with fork. Turn over. Return remainder to oven.	Do not defrost less than 1/4 lb. Freeze in doughnut shape.
Ground Beef, Patties	MEAT	Separate and rearrange.	Do not defrost less than two oz. patties. Depress center when freezing.
Round Steak	MEAT	Turn over. Cover warm areas with aluminum foil.	Place on a microwavable roasting rack.
Tenderloin Steak	MEAT	Turn over. Cover warm areas with aluminum foil.	Place on a microwavable roasting rack.
Stew Beef	MEAT	Remove thawed portions with fork. Separate remainder. Return remainder to oven.	Place in a microwavable baking dish.
Pot Roast, Chuck Roast	MEAT	Turn over. Cover warm areas with aluminum foil.	Place on a microwavable roasting rack.
Rib Roast	MEAT	Turn over. Cover warm areas with aluminum foil.	Place on a microwavable roasting rack.
Rolled Rump Roast	MEAT	Turn over. Cover warm areas with aluminum foil.	Place on a microwavable roasting rack.
LAMB			
Cubes for Stew	MEAT	Remove thawed portions with fork. Return remainder to oven.	Place in a microwavable baking dish.
Chops (1 inch thick)	MEAT	Separate and rearrange.	Place on a microwavable roasting rack.
PORK			
Chops (1/2 inch thick)	MEAT	Separate and rearrange.	Place on a microwavable roasting rack.
Hot Dogs	MEAT	Separate and rearrange.	Place on a microwavable roasting rack.
Spareribs Country-style Ribs	MEAT	Turn over. Cover warm areas with aluminum foil.	Place on a microwavable roasting rack.
Sausage, Links	MEAT	Separate and rearrange.	Place on a microwavable roasting rack.
Sausage, Bulk	MEAT	Remove thawed portions with fork. Turn over. Return remainder to oven.	Place in a microwavable baking dish.
Loin Roast, Boneless	MEAT	Turn over. Cover warm areas with aluminum foil.	Place on a microwavable roasting rack.

Operation

AUTO DEFROST CHART (CONTINUED)

Poultry setting

FOOD	SETTING	AT BEEP	SPECIAL INSTRUCTIONS
CHICKEN Whole (up to 6 lbs) Cut-up	POULTRY	Turn over (finish defrosting breast-side down). Cover warm areas with aluminum foil. Separate pieces and rearrange. Turn over. Cover warm areas with aluminum foil.	Place chicken breast-side up on a microwavable roast rack. Finish defrosting by immersing in cold water. Remove giblets when chicken is partially defrosted. Place on a microwavable roasting rack. Finish defrosting by immersing in cold water.
CORNISH HENS Whole	POULTRY	Turn over. Cover warm areas with aluminum foil.	Place on a microwavable roasting rack. Finish defrosting by immersing in cold water.
TURKEY Breast (under 6 lbs)	POULTRY	Turn over. Cover warm areas with aluminum foil.	Place on a microwavable roasting rack. Finish defrosting by immersing in cold water.

Fish setting

FOOD	SETTING	AT BEEP	SPECIAL INSTRUCTIONS
FISH Fillets	FISH	Turn over. Separate fillets when partially thawed if possible.	Place in a microwavable baking dish. Carefully separate fillets under cold water.
Steaks	FISH	Separate and rearrange.	Place in a microwavable baking dish. Run cold water over to finish defrosting.
Whole	FISH	Turn over.	Place in a microwavable baking dish. Cover head and tail with foil; do not let foil touch sides of microwave. Finish defrosting by immersing in cold water.
SHELLFISH Crabmeat	FISH	Break apart. Turn over.	Place in a microwavable baking dish.
Lobster tails	FISH	Turn over and rearrange.	Place in a microwavable baking dish.
Shrimp	FISH	Separate and rearrange.	Place in a microwavable baking dish.
Scallops	FISH	Separate and rearrange.	Place in a microwavable baking dish.

NOTE : Food to be defrosted must be not more than 6.0 lbs(4.0 Kg).

Operation

TIME DEFROST

This feature allows you to choose the time you want to defrost.

Example: To defrost for 2 minutes.

TIME
DEFROST

1. Touch **TIME DEFROST** pad.

2 0 0

2. Enter the defrosting time you want.

START

3. Touch **START** pad.
(Defrost starts)
When the defrost time is over, you will hear four beeps and **END** will display.

TWO POSITION METAL RACK

The two position Metal Rack gives you extra space when cooking in more than one container at the same time. The metal rack can be turned upside-down to help fit taller containers on the bottom of the oven.

CAUTION

Do not use oven rack while heating a single portion of food. Rack can cause an electrical arc and damage oven.

NOTE:

- Rack must be on 4 supports when used.
- Insert the rack securely into the four supports on the side walls of the oven.
- Turn the rack upside-down when using taller containers on the bottom of the oven.

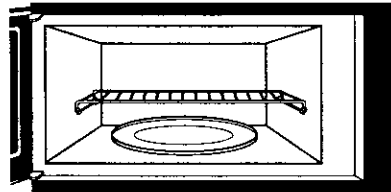
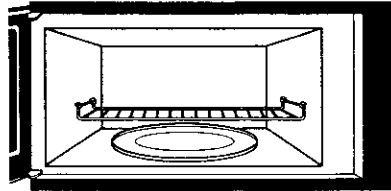

Cooking

GETTING THE BEST COOKING RESULTS

To get the best results from your microwave oven, read and follow the guidelines below.

- **Storage Temperature:** Foods taken from the freezer or refrigerator take longer to cook than the same foods at room temperature. The time for recipes in this book is based on the normal storage temperature of the food.
- **Size:** Small pieces of food cook faster than large ones, pieces similar in size and shape cook more evenly. For even cooking, reduce the power when cooking large pieces of food.
- **Natural Moisture:** Very moist foods cook more evenly because microwave energy is attracted to water molecules.
- **Stir** foods such as casseroles and vegetables from the outside to the center to distribute the heat evenly and speed cooking. Constant stirring is not necessary.
- **Turn over** foods like pork chops, baking potatoes, roasts, or whole cauliflower halfway through the cooking time to expose all sides equally to microwave energy.
- **Place** delicate areas of foods, such as asparagus tips, toward the center of the dish.
- **Arrange** unevenly shaped foods, such as chicken pieces or salmon steaks, with the thicker, meatier parts toward the outside of the dish.
- **Shield**, with **Small** pieces of aluminum foil, parts of food that may cook quickly, such as wing tips and leg ends of poultry.
- **Let It Stand:** After you remove the food from the microwave, cover food with foil or casserole lid and let it stand to finish cooking in the center and avoid overcooking the outer edges. The length of standing time depends on the density and surface area of the food.
- **Wrapping in waxed paper or paper towel:** Sandwiches and many other foods containing prebaked bread should be wrapped prior to microwaving to prevent drying out.

FISH & SHELLFISH

Cooking Fish and Shellfish: General Directions

- Prepare the fish for cooking.
 - Completely defrost the fish or shellfish.
 - Arrange unevenly shaped pieces with thicker parts toward the outside of the dish. Arrange shellfish in a single layer for even cooking.
 - The type of cover you use depends on how you cook. Poached fish needs a microwavable lid or **vented** plastic wrap.
 - Baked fish, coated fish, or fish in sauce needs to be covered lightly with waxed paper to keep the coating crisp and sauce from getting watery.
- Always set the shortest cooking time. Fish is done when it turns opaque and the thickest part begins to flake. Shellfish is done when the shell turns from pink to red and the flesh is opaque and firm.
- The Fish and Shellfish Cooking Table below provides specific directions with Power Level and Cooking Time settings for most types of fish and shellfish.

Fish And Shellfish Cooking Table

FISH	POWER LEVEL	COOKING TIME	DIRECTIONS
Fish fillets	HI	3 1/2-4 1/2 minutes	Arrange fish in a single layer with thickest portion toward outside edge of 1 1/2 quart microwavable baking dish. Brush with melted butter and season, if desired. Cook covered with vented plastic wrap. Let stand covered 2 minutes. If you are cooking more than 1 lb. of fish, turn the fish halfway through cooking.
Fish steaks	HI	4 1/2-5 1/2 minutes	
Whole fish	7	4 1/2-6 minutes	
Scallops	HI	3 1/2-5 minutes	Arrange in a single layer. Prepare as directed above, except stir instead of turning the shellfish.
Shrimp, shelled	HI	3 1/2-5 minutes	

Cooking

APPETIZERS / SAUCES / SOUPS

Cooking Appetizers: Tips and Techniques

Recommended

- Crisp crackers, such as melba toast, shredded wheat, and crisp rye crackers are best for microwave use. Wait until party time to add the spreads. Place a paper towel under the crackers while they cook in the microwave oven to absorb extra moisture.
- Arrange individual appetizers in a circle for even cooking.
- Stir dips to distribute heat and shorten cooking time.

Cooking Sauces: Tips and Techniques

- Use a microwavable casserole or glass measuring cup that is at least 2 or 3 times the volume of the sauce.
- Sauces made with cornstarch thicken more rapidly than those made with flour.

Cooking Soups: Tips and Techniques

- Cook soups in a microwavable dish which holds double the volume of the recipe ingredients to prevent boil-over, especially if you use cream or milk in the soup.
- Generally, cover microwaved soups with VENTED plastic wrap or a microwavable lid.
- Cover foods to retain moisture. Uncover foods to retain crispness.
- Avoid overcooking by using the minimum suggested time. Add more time, if necessary, only after checking the food.

Not Recommended

- Appetizers with a crisp coating or puff pastry are best done in a conventional oven with dry heat.
- Breaded products can be warmed in the microwave oven but will not come out crisp.
- Cook sauces made with cornstarch or flour uncovered so you may stir them 2 or 3 times during cooking for a smooth consistency.
- To adapt a conventional sauce or gravy recipe, reduce the amount of liquid slightly.
- Stirring occasionally will help blend flavors, distribute heat evenly, and may even shorten the cooking time.
- When converting a conventional soup recipe to cook in the microwave, reduce the liquid, salt, and strong seasonings.

MEAT

Cooking Meat: General Directions

- Prepare the meat for cooking.
 - Defrost completely.
 - Trim off excess fat to avoid splattering.
 - Place the meat, fat side down, on a microwavable rack in a microwavable dish.
 - Use oven cooking bag for less tender cuts of meat.
 - Arrange the meat so that thicker portions are toward the outside of the dish.
 - Cover the meat with waxed paper to prevent splattering.
- Tend the meat as it cooks.
 - Drain juices as they accumulate to reduce splattering and keep from overcooking the bottom of the meat.
 - Shield thin or bony portions with strips of foil to prevent overcooking.

NOTE: Keep the foil at least 1 inch from the oven walls, and do not cover more than one-third of the meat with foil at any one time.

- Let the meat stand covered with foil 10-15 minutes after you remove it from the oven. The internal temperature of the meat may rise from 5-10°F during standing time.

The Meat Cooking Table on the next page provides detailed directions, Power Level, and Cooking Time settings for most cuts of meat.

Cooking

Meat Cooking Table

MEAT	POWER LEVEL	COOKING TIME	DIRECTIONS
Beef Hamburgers, Fresh or defrosted (4 oz. each) 1 patty 2 patties 4 patties	HI	1-1 1/2 minutes 1 1/2-2 minutes 2 1/2-3 1/2 minutes	Form patties with depression in center of each. Place on microwavable roast rack. Brush with browning agent, if desired. Cover with waxed paper. Turn over halfway through cooking. Let stand covered 1 minute.
Sirloin tip roast (3-4 lbs.)	5	8-10 minutes per pound RARE(135°F) 11-13 minutes per pound MEDIUM(155°F)	Place roast fat side down on microwavable roast rack. Add desired seasonings and cover with waxed paper. Turn meat over halfway through cooking and shield if necessary. Remove roast from microwave oven when desired temperature is reached. Let stand covered with foil 15 minutes.(Temperature may rise about 10°F).
Lamb Lamb roast, rolled boneless (3-4 lbs.)	5	11-12 minutes per pound RARE(135°F) 12-13 minutes per pound MEDIUM(145°F) 13-14 minutes per pound WELL(155°F)	Place roast fat side down on microwavable roast rack. Brush lamb with marinade or desired seasonings such as rosemary, thyme or marjoram. Cover with waxed paper. Turn roast over after 15 minutes, and again after 30 minutes. Shield if necessary. Remove roast from microwave when desired temperature is reached. Let stand covered with foil 15 minutes (Temperature may rise about 10°F).
Pork Bacon slices 2 slices 4 slices 6 slices	HI	1 1/2-2 minutes 2 1/2-3 minutes 3 1/2-4 1/2 minutes	Place bacon slices on microwavable roast rack. Cover with paper towels. After cooking, let stand 1 minute.
Chops (5-7 oz. each) 2 chops 4 chops	3	18-20 minutes per pound 15-17 minutes per pound	Place chops in microwavable baking dish. Add desired seasonings and cover with vented plastic wrap. Cook until no longer pink or until internal temperature reaches 170°F. Turn chops over halfway through cooking. Let stand covered 5 minutes. (Temperature may rise about 10°F).
Loin Roast, rolled, boneless (3 1/2- 4 1/2 lbs.)	3	25-27 minutes per pound (165°F)	Place roast in cooking bag in microwavable dish. Add seasonings and browning agent if desired. Close bag loosely with microwavable closure or string. After cooking, let stand in bag 15 minutes. (Temperature may rise about 10°F.) Internal temperature of pork should reach 170°F before serving.
Sausage links, Fresh or Frozen, defrosted (1-2 oz. each) 2 links 4 links 6 links 10 links (8 oz. pkg.)	HI	45-60 seconds 1-1 1/2 minutes 1 1/2-2 minutes 1 3/4-2 minutes	Pierce links and place on microwavable roast rack. Cover with waxed paper or paper towel. Turn over halfway through cooking. After cooking, let stand covered 1 minute.

Cooking

POULTRY

Cooking Poultry: General Directions

- Prepare the poultry for cooking.
 - Defrost completely.
 - Arrange poultry pieces with thicker pieces at the outside edge of the baking dish. When cooking legs, arrange them like the spokes of a wheel.
 - Cover the baking dish with waxed paper to reduce splattering.
 - Use a browning agent or cook with a sauce to give a browned appearance.
- Watch the poultry as it cooks.
 - Drain and discard juices as they accumulate.
 - Shield thin or bony pieces with small strips of aluminum foil to prevent overcooking. Keep foil at **least 1 inch** from the oven walls and other pieces of foil.
- Poultry is done when it is no longer pink and the juices run clear. When done, the temperature in the thigh meat should be 180-185°F.
- Let the poultry stand after cooking covered with foil for 10 minutes.

The Poultry Cooking Table below provides detailed directions, Power Level, and Cooking Time settings for most cuts and types of poultry.

Poultry Cooking Table

POULTRY	POWER LEVEL	COOKING TIME	DIRECTIONS
Chicken pieces (2 1/2-3 lbs).	HI	4 1/2-5 1/2 minutes per pound	Wash, shake the water off, and go on with cooking. Place pieces in a single layer in a microwavable baking dish with thicker pieces to the outside. Brush with butter or browning agent and seasonings if desired. Cover with waxed paper. Cook until no longer pink and juices run clear. Let stand covered 5 minutes.
Chicken whole (3-3 1/2 lbs)	HI	12-13 minutes per pound	Before cooking, wash and shake off water. Place breast side down on a microwavable roast rack. Brush with butter, or browning agent and seasoning if desired. Cover with waxed paper. Cook 1/3 of estimated time. Turn breast side up, brush with butter, or browning agent. Replace waxed paper. Cook 1/3 of estimated time again. Shield if necessary. Cook remaining 1/3 of estimated time or until no longer pink and juices run clear. Let stand covered with foil 10 minutes. (The temperature may rise about 10°F.) The temperature in the thigh should be 180°F-185°F when the poultry is done.
Cornish Hens Whole (1-1 1/2 lbs. each)	HI	6-7 minutes per pound	Wash, shake the water off, and go on with cooking. Tie wings to body of hen and the legs to tail. Place hens breast side down on microwavable rack. Cover with waxed paper. Turn breast side up halfway through cooking. Shield bone ends of drumsticks with foil. Remove and discard drippings. Brush with butter or browning agent and seasonings if desired. Cook until no longer pink and juices run clear. Remove hens from microwave when they reach desired temperature. Let stand covered with foil 5 minutes. (Temperature may rise about 10°F). Temperature in breast should be 170°F before serving.

Cooking

PASTA AND RICE

Microwave cooking and conventional cooking of pasta, rice, and cereal require about the same amount of time, but the microwave is a more convenient method because you can cook and serve in the same dish.

There is no stirring needed and leftover pasta tastes just like fresh cooked when reheated in the microwave oven.

Cooking Pasta and Rice: Tips and Techniques

- If you are planning to use rice or pasta in a casserole, undercook it so it is still firm.
- Allow for standing time with rice, but not for pasta.
- The Pasta and Rice Cooking Tables below provide specific directions, with Power Level and cooking time settings for most common types of pasta and rice.

Pasta Cooking Table

TYPE OF PASTA	POWER LEVEL	COOKING TIME	DIRECTIONS
Spaghetti 4 cups water Add 8 oz. spaghetti	HI 5	9 to 10 minutes 7 1/2 to 8 1/2 minutes	Combine hot tap water and salt, if desired. Use a 2-quart microwavable baking dish and cover with vented plastic wrap for spaghetti and lasagna noodles. Use microwavable lid or vented plastic wrap for macaroni and egg noodles. Cook at Power Level HI as directed in chart or until water boils. Stir in pasta; cook covered at Power Level 5 as directed in chart or until tender. Drain in a colander.
Macaroni 3 cups water Add 2 cups macaroni	HI 5	6 to 7 minutes 5 1/2 to 6 1/2 minutes	
Lasagna noodles 4 cups water Add 8 oz. lasagna noodles	HI 5	7 to 8 minutes 11 to 12 1/2 minutes	
Egg noodles 6 cups water Add 4 cups noodles	HI 5	8 to 10 minutes 5 1/2 to 6 1/2 minutes	

Rice Cooking Table

TYPE OF RICE	POWER LEVEL	COOKING TIME	DIRECTIONS
Long grain 2 1/4 cups water Add 1 cup rice	HI 5	4 1/2 to 5 1/2 minutes 14 minutes	Combine hot tap water and salt, if desired, in 2 quart microwavable casserole. Cover with microwavable lid or vented plastic wrap. Cook as directed in chart at Power Level HI or until water boils. Stir in rice and any seasonings. Cook covered as directed in chart at Power Level 5 or until water is absorbed and rice is tender. Let stand covered 5 to 10 minutes. Fluff with fork.
Brown 2 1/2 cups water Add 1 cup rice	HI 5	4 1/2 to 5 1/2 minutes 28 minutes	
Long grain and wild rice mix 2 1/3 cups water Add 6 oz. pkg.	HI 5	4 to 5 minutes 24 minutes	
Quick cooking 1 cup water Add 1 cup rice	HI	2 to 3 minutes	Cook water until it boils. Stir rice into boiling water and let stand, covered 5 to 10 minutes or until water is absorbed and rice is tender. Fluff with fork.

Maintenance

CARE AND CLEANING

For best performance and safety, keep the oven clean inside and outside. Take special care to keep the inner door panel and the oven front frame free of food or grease build-up.

Never use abrasive cleaners or pads. Wipe the microwave oven inside and out, including the hood bottom cover, with a soft cloth and a warm (not hot) mild detergent solution. Then rinse and wipe dry. Use a chrome cleaner and polish on chrome, metal, and aluminum surfaces. Wipe spatters immediately with a wet paper towel, especially after cooking chicken or bacon. Clean your oven weekly or more often, if needed.

METAL RACK

Wash the metal rack with a mild soap and a soft or nylon scrub brush. Dry completely. Do not use abrasive scrubbers or cleaners to clean rack.

CLEANING THE GREASE FILTERS

The grease filters should be removed and cleaned often, at least once a month.

1. To remove grease filters, slide each filter back. Pull filters downward and push to the other side. The filter will drop out.

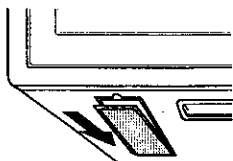

2. Wash in dishwasher or soak grease filters in hot water and a mild detergent. Rinse well and shake to dry. **Do not use ammonia. The aluminum will darken filter.**

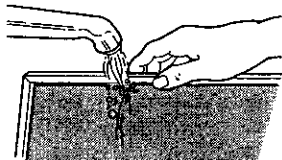

3. To reinstall the filters, slide it into the side slot, then push up and toward front to lock.

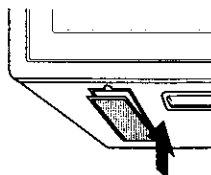

CAUTION

Do not operate the hood without the filters in place.

CHARCOAL FILTER REPLACEMENT

If your oven is vented inside, the charcoal filter should be replaced every 6 to 12 months, and more often if necessary. The charcoal filter cannot be cleaned. To order a new charcoal filter, contact the Parts Department at your nearest Authorized Service Center or call Amana at 1-800-843-0304 (inside U.S.A.) 1-319-622-5511 (outside U.S.A.).

Order Charcoal Filter kit # : MVHRK2.

1. Disconnect Power to oven.
2. Remove the two vent grille mounting screws. (2 middle screws)

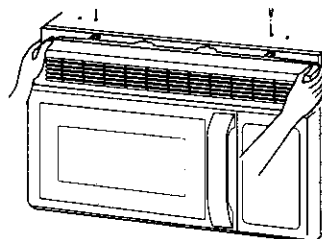

3. Tip the grille forward, then lift it out.
4. Remove old filter.

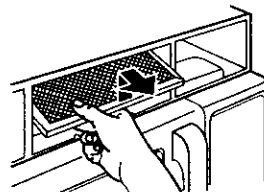

5. Slide a new charcoal filter into place. The filter should rest at the angle shown.

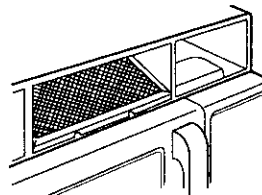

6. Slide the bottom of the grille into place. Push the top until it snaps into place. Replace the mounting screws. Turn the power back on at the main power supply and set the clock.

Maintenance

COOKTOP/NIGHT LIGHT REPLACEMENT

1. Unplug the oven or turn off power at the main power supply.

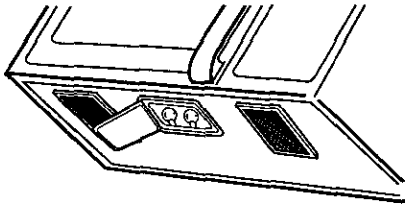

2. Remove the bulb cover mounting screw.
3. Replace bulb(s) with 30 watt appliance bulb(s).
4. Replace bulb cover.
5. Turn the power back on at the main power supply.

OVEN LIGHT REPLACEMENT

1. Unplug oven or turn off power at the main power supply.
2. Remove the vent cover mounting screws.(2 middle screws)
3. Tip the cover forward, then lift out to remove.

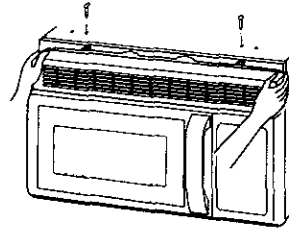

4. Remove bulb holder.

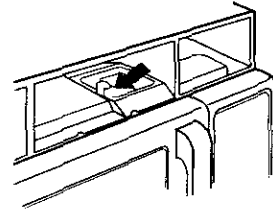

5. Lift up the bulb holder.

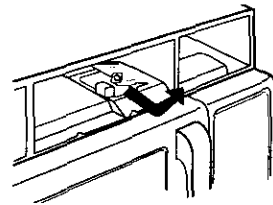

6. Replace bulb with a 30 or 40 watt appliance bulb.
7. Replace the bulb holder and mounting screw.
8. Slide the bottom of the vent cover into place. Push the top until it snaps into place. Replace the mounting screws. Turn the power back on at the main power supply.

Maintenance

MICROWAVE UTENSIL GUIDE

USE	DO NOT USE
<p>OVENPROOF GLASS (treated for high intensity heat): utility dishes, loaf dishes, pie plates, cake plates, liquid measuring cups, casseroles and bowls without metallic trim.</p> <p>CHINA: bowls, cups, serving plates and platters without metallic trim.</p> <p>PLASTIC: Plastic wrap (as a cover)-- lay the plastic wrap loosely over the dish and press it to the sides. Vent plastic wrap by turning back one edge slightly to allow excess steam to escape. The dish should be deep enough so that the plastic wrap will not touch the food. As the food heats it may melt the plastic wrap wherever the wrap touches the food. Use plastic dishes, cups, semirigid freezer containers and plastic bags only for short cooking time. Use these with care because the plastic may soften from the heat of the food.</p> <p>PAPER: Paper towels, waxed paper, paper napkins, and paper plates with no metallic trim or design. Look for the manufacturer's label for use in the microwave oven.</p>	<p>METAL UTENSILS: Metal shields the food from microwave energy and produces uneven cooking. Also avoid metal skewers, thermometers or foil trays. Metal utensils can cause arcing, which can damage your microwave oven.</p> <p>METAL DECORATION: Metal-trimmed or metal-banded dinnerware, casserole dishes, etc. The metal trim interferes with normal cooking and may damage the oven.</p> <p>ALUMINUM FOIL: Avoid large sheets of aluminum foil because they hinder cooking and may cause harmful arcing. Use small pieces of foil to shield poultry legs and wings. Keep ALL aluminum foil at least 1 inch from the side walls and door of the oven.</p> <p>WOOD: Wooden bowls and boards will dry out and may split or crack when you use them in the microwave oven. Baskets react in the same way.</p> <p>TIGHTLY COVERED UTENSILS: Be sure to leave openings for steam to escape from covered utensils. Pierce plastic pouches of vegetables or other food items before cooking. Tightly closed pouches could explode.</p> <p>BROWN PAPER: Avoid using brown paper bags. They absorb too much heat and could burn.</p> <p>FLAWED OR CHIPPED UTENSILS: Any utensil that is cracked, flawed, or chipped may break in the oven.</p> <p>METAL TWIST TIES: Remove metal twist ties from plastic or paper bags. They become hot and could cause a fire.</p>

Trouble shooting

BEFORE CALLING FOR SERVICE

Check the following list to be sure a service call is really necessary. A quick reference of this manual as well as reviewing additional information on items to check may prevent an unneeded service call.

If nothing on the oven operates:

- check for a blown circuit fuse or a tripped main circuit breaker.
- check if oven is properly connected to electric circuit in house.
- check that controls are set properly.

If the oven interior light does not work:

- the light bulb is loose or defective.

If oven will not cook:

- check that control panel was programmed correctly.
- check that door is firmly closed.
- check that Start Pad was touched.
- check that timer wasn't started instead of a cook function.

If oven takes longer than normal to cook or cooks too rapidly:

- be sure the Power Level is programmed properly.

If the time of day clock does not always keep correct time:

- check that the power cord is fully inserted into the outlet receptacle.
- be sure the oven is the only appliance on the electrical circuit.

If food cooks unevenly:

- be sure food is evenly shaped.
- be sure food is completely defrosted before cooking.
- check placement of aluminum foil strips used to prevent overcooking.

If food is undercooked:

- check recipe to be sure all directions (amount, time, & power levels) were correctly followed.
- be sure microwave oven is on a separate circuit.
- be sure food is completely defrosted before cooking.

If food is overcooked:

- check recipe to be sure all directions (amount, power level, time, size of dish) were followed.

If arcing (sparks) occur:

- be sure microwavable dishes were used.
- be sure wire twist ties weren't used.
- be sure oven wasn't operated when empty.
- make sure metal rack (if used) is properly installed on 4 supports.

If the Display shows a time counting down but the oven is not cooking:

- check that door is firmly closed.
- check that timer wasn't started instead of a cooking function.

Vent fan starts automatically. If the temperature gets too hot around the microwave oven, the fan in the vent hood will automatically turn on at the LOW setting to cool the oven. It may stay on up to an hour to cool the oven.

QUESTIONS AND ANSWERS

Q. Can I use a rack in my microwave oven so that I may reheat or cook in two levels at a time?

- A. Only use the rack that is supplied with your microwave oven. Use of any other rack can result in poor cooking performance and/or arcing and may damage your oven.

Q. Can I use either metal or aluminum pans in my microwave oven?

- A. Usable metal includes aluminum foil for shielding (use small, flat pieces). Never allow metal to touch walls or door.

Q. Sometimes the door of my microwave oven appears wavy. Is this normal?

- A. This appearance is normal and does not affect the operation of your oven.

Q. What are the humming noises that I hear when my microwave oven is operating?

- A. You hear the sound of the transformer when the magnetron tube cycles on and off.

Q. Why does the dish become hot when I microwave food in it? I thought that this should not happen.

- A. As the food becomes hot it will conduct the heat to the dish. Use hot pads to remove food after cooking. Dish may not be microwave safe.

Q. What does standing time mean?

- A. Standing time means that food should be taken out of the oven and covered for additional time after cooking. This process allows the cooking to finish, saves energy, and frees the oven for other purpose.

Q. Can I pop popcorn in my microwave oven? How do I get the best results?

- A. Yes. Pop packaged microwave popcorn following manufacturer's guidelines or use the preprogrammed Popcorn pad. Do not use regular paper bags. Use the listening test by stopping the oven as soon as the popping slows to a pop every one or two seconds. Do not try to repop unpopped kernels. You can also use special microwave poppers. When using a popper, be sure to follow manufacturer's directions. Do not pop popcorn in glass utensils.

Q. Why does steam come out of the air exhaust vent?

- A. Steam is normally produced during cooking. The microwave oven has been designed to vent this steam out the top vent.

Installation

YOUR SAFETY FIRST

Read this entire manual before you begin.

BEFORE YOU START

- **Proper installation is the installer's responsibility!**
 - Write the model & serial numbers on the owner's manual. The model number label is located on the oven front. The mounting plate is located on the back side of the microwave oven. See Figure 1.

BE SURE TO READ THE FOLLOWING SAFETY INSTRUCTIONS:

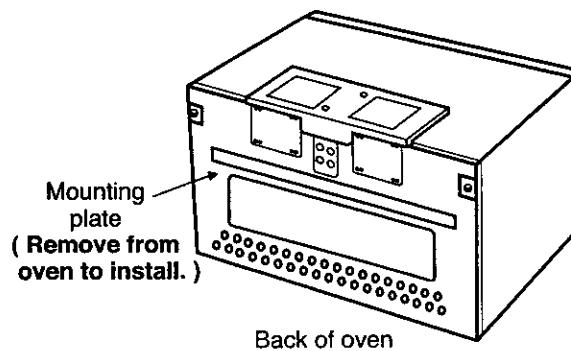

Figure 1

⚠ WARNING

FOR YOUR SAFETY:

- You will need **TWO** people to install this oven. It is heavy and could cause personal injury if not handled properly.
- **Avoid Electrical Shock!**
 - Before you drill into the wall, note where electrical outlets are and where electrical wires might be concealed behind the wall. **YOU COULD GET AN ELECTRIC SHOCK** if you contact electrical wires with your drill bit.
 - Locate and disconnect the power to any electrical circuits that could be affected by installing this oven. **IF YOU DO NOT DISCONNECT THE POWER, YOU COULD GET AN ELECTRIC SHOCK.**
 - You need a **DEDICATED** 120V, 60Hz, AC only, 15 or 20A, fused electrical supply (located in the cabinet above the microwave as close as possible to the microwave) serving only the microwave.

Installation

YOUR SAFETY FIRST

WARNING

If you use the grounding plug improperly, you risk electric shock!

- Check with a qualified electrician if you are not sure whether the oven is properly grounded or if you do not completely understand the grounding instructions.
DO NOT USE A FUSE IN THE NEUTRAL OR GROUNDING CIRCUIT.

WARNING

Improper grounding could result in electric shock or other personal injury.

SAVE THESE INSTRUCTIONS FOR THE LOCAL ELECTRICAL INSPECTOR'S USE.

- **THIS APPLIANCE MUST BE GROUNDED!**

- If there is an electrical short circuit, grounding reduces the risk of electrical shock by providing an escape wire for the electric current. This appliance is equipped with a cord having a grounding wire with a grounding plug.
 - Place the plug into a properly installed and grounded outlet. See Figure 2.
 - Do not use an extension cord.
 - Keep the power cord dry and do not pinch or crush it.

- **DO NOT, UNDER ANY CIRCUMSTANCES, REMOVE THE POWER SUPPLY CORD GROUNDING PRONG!**

This appliance **MUST** be grounded!

PROPERLY POLARIZED AND
GROUNDED OUTLET

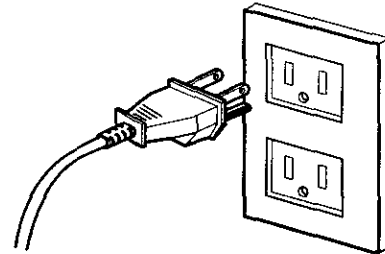

Three-Pronged (Grounding) Plug
Figure 2

WARNING

**If you do not use the microwave oven as instructed,
you could be exposed to excessive microwave energy.**

- **DO NOT EXPOSE YOURSELF TO EXCESSIVE MICROWAVE ENERGY!**

- DO NOT try to operate the microwave oven with the door open.
- DO NOT tamper with or defeat the safety interlocks.
- DO NOT place objects between the microwave oven front face and the door.
- DO NOT allow soil or cleaner residue to build up on the flat surfaces around the microwave oven door.
- DO NOT operate the microwave oven if it is damaged.
- The microwave oven door must close properly to operate safely.
- DO NOT USE THE MICROWAVE OVEN:
 - If the door is bent.
 - If the hinges or latches are broken or loose.
 - If the door seals, sealing surfaces or glass is broken.
- DO NOT ATTEMPT TO ADJUST OR REPAIR THE OVEN YOURSELF!
It should be adjusted and repaired by a qualified technician who can check for microwave leakage after repairing the oven.

Installation

YOUR SAFETY FIRST

⚠ WARNING

If you do not mount the oven as instructed, you risk personal injury and/or property damage.

⚠ CAUTION

Before you begin installing the oven, PLACE A PIECE OF THE CARTON OR OTHER HEAVY MATERIAL (a blanket) over the countertop or cooktop to protect it. **Do not use a plastic cover.** Failure to protect these surfaces could result in property damage.

• MAKE SURE YOU HAVE ENOUGH SPACE AND SUPPORT.

- Mount the oven against a flat, vertical wall, so it is supported by the wall. The wall should be constructed of minimum 2" x 4" wood studding and 3/8" thick drywall or plaster/lath.
- ATTACH AT LEAST ONE of the two lag screws supporting the oven to a vertical, 2" x 4" wall stud.
- DO NOT mount the microwave oven to an island or peninsula cabinet.
- BE SURE the upper cabinet and rear wall structures are able to support 150 lbs., plus the weight of any items you place inside the oven or upper cabinet.
- Locate the oven away from strong draft areas, such as windows, doors, and strong heating vents.
- BE SURE you have enough space. See Figure 3 below for minimum vertical and horizontal clearance.
- This microwave oven can be installed over gas or electric cooking products no more than 36 inches wide.

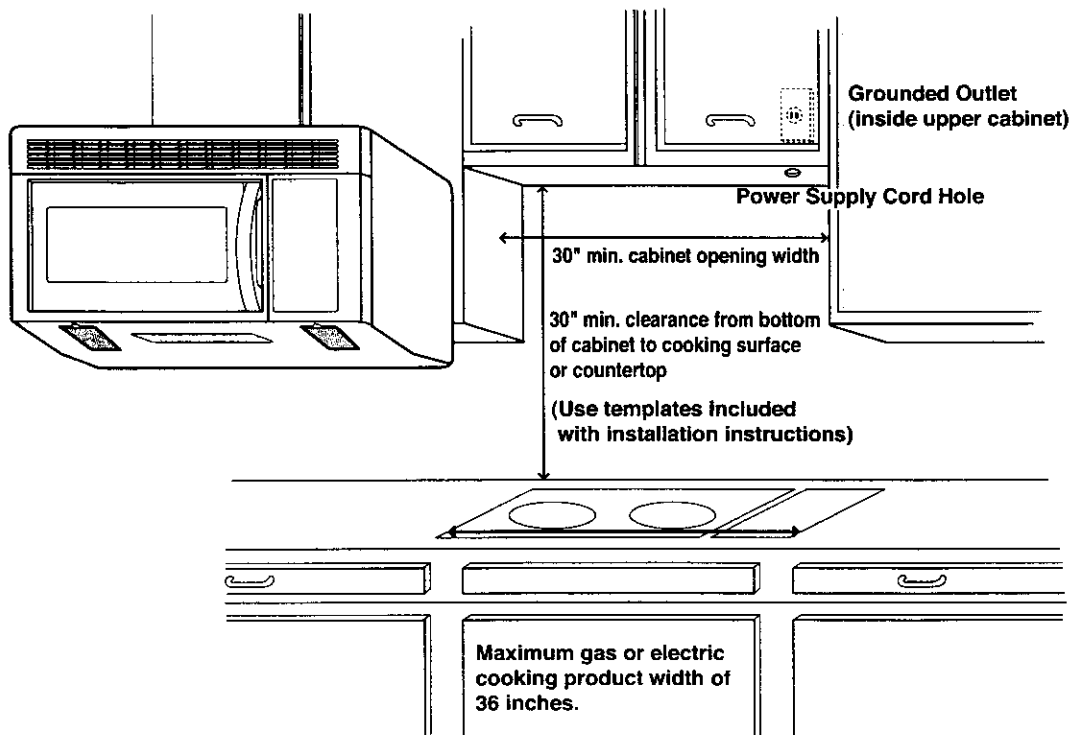

Figure 3

Installation

PARTS, TOOLS, MATERIALS

THE FOLLOWING PARTS ARE SUPPLIED WITH THE OVEN:

NOTE: Depending on your ventilation requirements, you may not use all of these parts.

Backdraft damper / duct connector
 (for roof-venting or wall-venting installation) □
 Not Actual Size (2 pieces must be □
 assembled as shown)



One power cord clamp and
One dark-colored mounting screw
 (to hold the power cord) □
 Actual Size

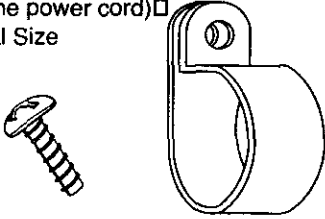

Two self - tapping screws - Actual Size
 (for attaching the damper duct connector) □



One lock pin and one washer-Not Actual size

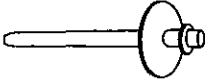

One power cord clamp bushing - Actual Size □
 (for the cord hole in a metal upper cabinet)



Four 1/4" x 2" lag screws - Actual Size □
 (for wall stud holes)

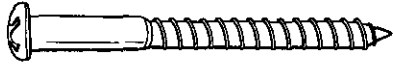

Four 1/4" x 3" toggle bolts - Actual Size □
 (for drywall holes)



Two 1/4" x 2" or 3" bolts - Actual Size □
 (for securing to the upper cabinet)

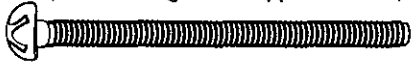

Four spring toggle heads - Actual Size □
 (for the toggle bolts)

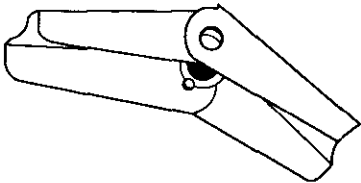

Two washers - Actual Size □
 (for the two upper cabinet bolts)

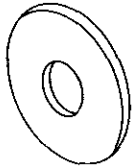

NOTE: You need to install at least 2 lag screws into one 2" x 4" stud and four anchor bolts into the wall. The mounting area must meet the 150 lbs. weight requirement.

Installation

PARTS, TOOLS, MATERIALS

YOU WILL NEED THE FOLLOWING TOOLS AND MATERIALS FOR THE INSTALLATION:

Carton or other heavy material for covering the counter top.

Clear tape
(for taping the templates to the wall)



Stud finder or thin nail.

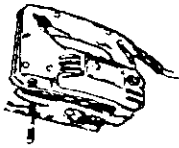

Saber saw (for cutting vent holes for roof or wall venting)

Keyhole saw (for the power cord hole)

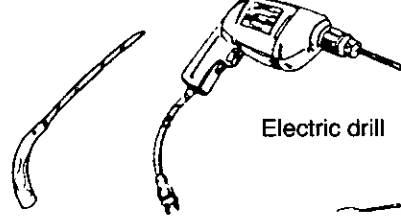

Electric drill

Phillips screwdriver (for the screws)



3/8" and 3/4" wood drill bits



Pencil



1/2" and 3/16" drill bits



Flat blade screwdriver (for the toggle bolts)

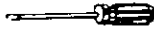

Plumb line

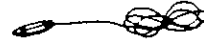

Measuring tape (metal preferred)



Duct Tape



Small side cutters or tin snips



Caulking gun



- If you have brick or masonry walls, you will need special hardware and tools.
- The ductwork you need for the installation is not included. All wall and roof caps must have a back-draft damper.

Installation

STEP 1: PREPARE THE ELECTRICAL CONNECTIONS

WARNING - FIRE HAZARD

AVOID ELECTRICAL SHOCK! THIS APPLIANCE MUST BE GROUNDED!

Improper grounding could result in electric shock or other personal injury.

- **DO NOT, UNDER ANY CIRCUMSTANCES, REMOVE THE POWER SUPPLY CORD GROUNDING PRONG!**
This appliance **MUST** be grounded!

1. Locate the grounded electric outlet for this oven in the cabinet above the oven, as shown in Figure 4.

NOTE: The outlet should be on a circuit dedicated to the microwave oven (120V, 60Hz., AC only) with a 15 or 20A fused electrical supply.

IMPORTANT: If you do not have the proper wall outlet, you **MUST** have one installed by a qualified electrician.

2. You will cut the power-supply-cord hole (shown in Figure 4) later when you prepare the wall and upper cabinet in Step 4.

NOTE: Do not use an extension cord.
Keep the power cord dry and do not pinch or crush it.

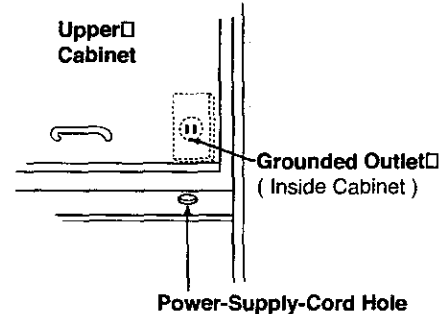

Figure 4

Installation

STEP 2: PREPARE THE VENTING SYSTEM

⚠ WARNING - FIRE HAZARD
THIS OVEN MUST BE PROPERLY VENTED!

NOTE: The ductwork you need for outside ventilation is not included with your oven. The standard ductwork fittings and length are shown in Figure 9.

You may vent your oven in one of three ways. However, do NOT vent into a wall cavity, an attic, or an unused area.

Roof-venting If your oven is located on an outside wall near the roof, as in Figures 6 (3/4" x 10" duct) and Figure 8 (6" round duct.)

Wall-venting If your oven is located on an outside wall of your house, as in Figure 5 (3/4" x 10" duct) and Figure 8 (6" round duct.)

Room-venting If your oven is located on an inside wall of your house, as in Figure 7.

NOTE: If you choose the rear exhaust method (roof-or wall-venting), be sure there is enough clearance within the wall for the exhaust duct.

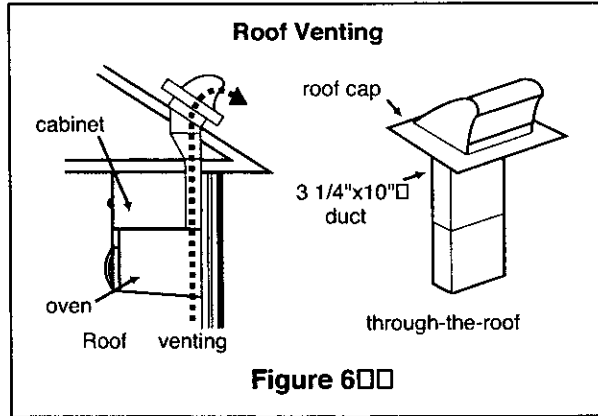
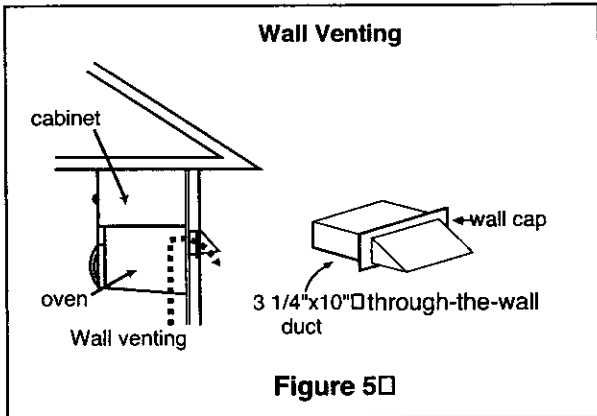

REMEMBER AS YOU INSTALL THE VENTING:

- Keep the length of the ductwork and the number of elbows to a minimum to ventilate your oven efficiently. See examples on next page.
- Keep the size of the ductwork the same.
- Do not install two elbows together.
- Use duct tape to seal all joints in the duct system.
- Use caulking gun to seal the exterior wall or roof opening around the cap.

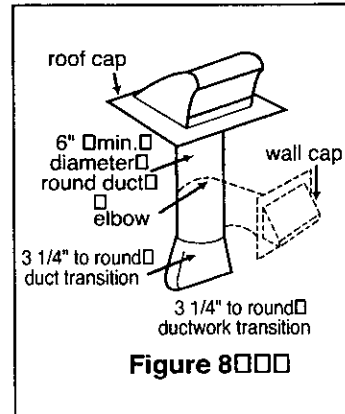
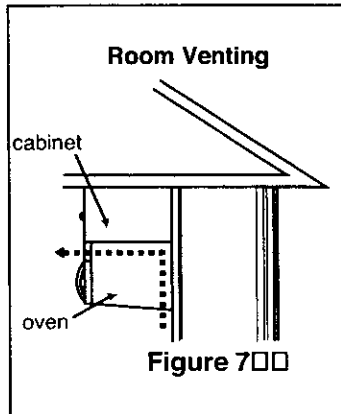

Installation

STEP 2: PREPARE THE VENTING SYSTEM

STANDARD FITTINGS

NOTE: If the existing duct is round, you must use a rectangular-to-round adapter, with a rectangular 3" extension duct installed between the damper assembly and the adapter to prevent the exhaust damper's sticking.

DUCT LENGTH

The total length of the duct system, including straight duct, elbows, transitions, and wall or roof caps **must not exceed the equivalent of 140 feet.**

For best performance, do not use more than three 90 degree elbows, and keep length as short as possible.

Below are the standard fittings and their equivalent length in feet.







1 □  3 1/4"x10" □ to 6"=5ft.	2 □  3 1/4"x10" roof □ cap=24ft.	3 □  3 1/4"x10" 90° □ elbow=25ft.	
4 □  90° elbow □ =10ft.	5 □  3 1/4"x10" □ wall cap □ =40ft.	6 □  45° elbow □ =5ft.	7 □  3 1/4"x10" □ flat elbow □ =10ft.

Figure 9

To calculate the equivalent length of each ductpiece used, see the examples below.

Examples	
<p>For 3 1/4"x10" SYSTEMS</p> 	<p>For 6" ROUND SYSTEMS</p> 
<p>1-3 1/4" x 10" 90° elbow □ = 25 ft. □</p> <p>1-Wall Cap □ = 40 ft. □</p> <p>8 feet straight duct □ = 8 ft. □</p> <p>TOTAL LENGTH □ = 73 ft. □</p>	<p>1-transition □ = 5 ft. □</p> <p>2-90° elbows □ = 20 ft. □</p> <p>1-Wall Cap □ = 40 ft. □</p> <p>8 feet straight □ = 8 ft. □</p> <p>TOTAL LENGTH □ = 73 ft. □</p>

Installation

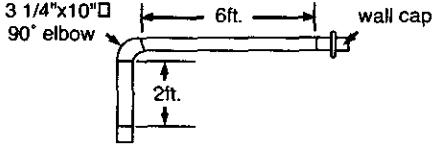
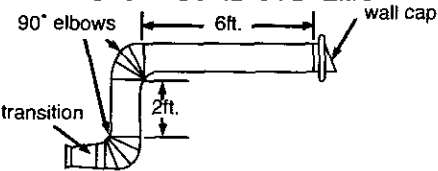
STEP 3: PREPARE THE VENTING BLOWER

WARNING

**ELECTRICAL SHOCK HAZARD!
UNPLUG UNIT BEFORE WORKING ON IT.**

- DO NOT PULL OR STRETCH THE BLOWER WIRING!
Pulling and stretching the blower wiring could result in electrical shock.

Your microwave oven is shipped with the blower assembled for roof venting. If you want wall-venting or room-vented (recirculating) installation, you must change the fan, as detailed below.

Remove two screws that attach mounting plate to microwave oven cabinet. See Figure 10.
Remove mounting plate and set aside. Discard the screws.

ROOF-VENTED INSTALLATION:

Go to STEP 4.

WALL-VENTED INSTALLATION:

1. Remove one blower unit mounting screw and two blower plate screws. Remove the blower plate from cabinet. See Figure 11.
2. Carefully lift the blower unit out of the microwave oven.
3. Use side cutters or tin snips to cut and remove knockouts part "B" from Back plate. Discard knockouts. Be careful not to distort the plate. See Figure 12.
4. Pull out the blower wire from wire clip, and put blower wire in another clip. See figure 13.
5. Rotate the unit so that the exhaust ports face the rear of the cabinet. See Figure 14. When you insert blower unit, blower wire must be like figure 14.
6. Place blower unit back into cabinet. Check that the exhaust ports face towards the rear of the cabinet. See Figure 15.
7. Reattach the blower plate to cabinet so the exhaust ports and blower plate opening are aligned. Attach with one blower unit mounting screw and then two blower plate mounting screws. See Figure 16.

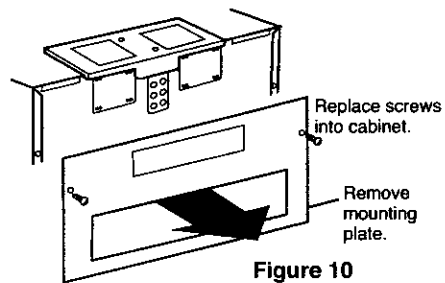

Figure 10

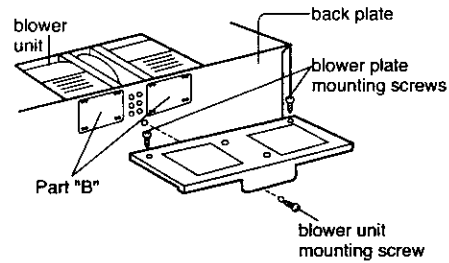

Figure 11

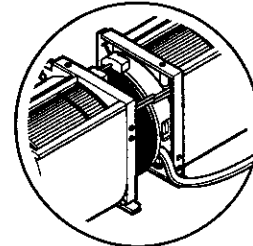

Figure 13

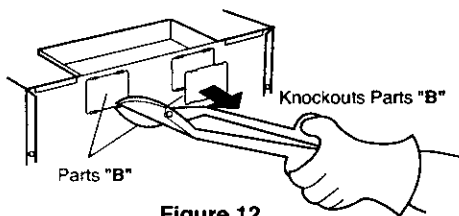

Figure 12

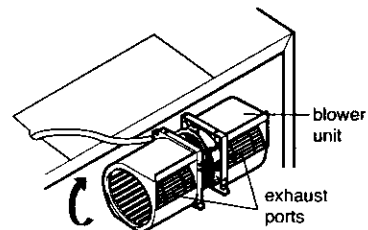

Figure 14

Installation

STEP 3: PREPARE THE VENTING BLOWER

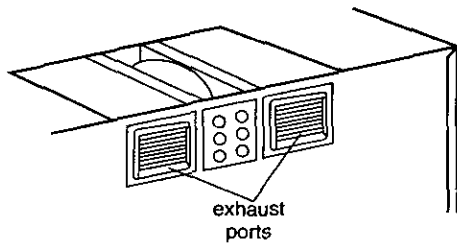

Figure 15

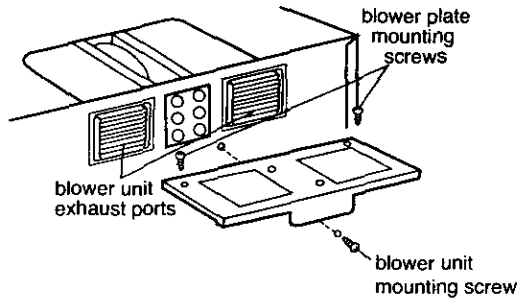

Figure 16

ROOM-VENTED (Recirculating) INSTALLATION:

1. Remove one blower unit mounting screw and two blower plate screws. Remove the blower plate from cabinet. See Figure 17.
2. Carefully lift the blower unit out of the microwave oven.
3. Rotate blower unit 90° so the exhaust ports face the front of the cabinet. See Figure 18.
4. Place the blower unit back into the microwave oven.
5. Reattach blower plate to microwave oven. Attach with one blower unit mounting screw and then two blower plate mounting screws. See Figure 19.

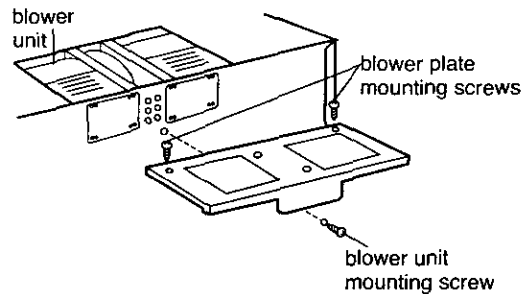

Figure 17

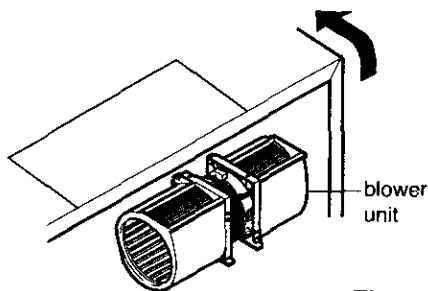

Figure 18

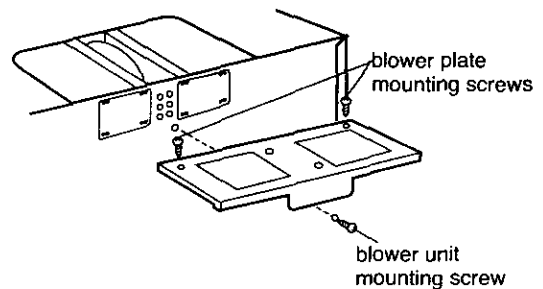

Figure 19

Installation

STEP 4: PREPARE THE WALL AND UPPER CABINET FOR INSTALLATION

CAUTION

Before you begin installing the oven, PLACE A PIECE OF THE CARTON OR OTHER HEAVY MATERIAL (a blanket) over the countertop or cooktop to protect it. **Do not use a plastic cover.** Failure to protect these surfaces could result in property damage.

BEFORE YOU START

1. Remove any shipping materials and parts from inside the microwave oven.
2. Cover the counter top or cooktop with a thick, protective covering to protect it from damage and dirt. See Figure 20.

NOTE: If you have a free-standing range, disconnect it, move it onto a piece of cardboard or hardboard and pull it away from the wall, so that you can get closer to the upper cabinet and back wall for easier measuring and drilling. Be careful not to pinch or damage the cord when you push the range back.

MEASURE AND TACK / TAPE UP THE TEMPLATES

1. Using a plumb line and (metal) measuring tape, find and mark the vertical center line on the back wall, as in Figure 21.
2. Find and mark one or two points where the studs are on the wall. (Studs are normally 16 inches apart) Then measure and mark the stud locations within the area marked H on the wall template. If you cannot find any wall stud, consult a local building contractor.

CAUTION

DO NOT ATTEMPT TO INSTALL THE MICROWAVE OVEN IF YOU CANNOT FIND A WALL STUD.

3. Line up the plumb line on the wall with the center line on the wall template.

NOTE: Be sure the minimum width is 30 inches and the distance from the top of the wall template to the range or counter top is at least 30 inches. See Figure 21.

4. Securely tape or tack the wall template to the wall. See Figure 22.

NOTE: If the cabinets are not plumb, adjust the wall template to the cabinets.

Remember, the oven must hang level.

If the front edge of the cabinet is lower than the back edge, adjust the wall template to be level with the cabinet front.

5. Measure the bottom of the upper cabinet frame. Trim the edges **A**, **B** and **C** on the upper cabinet template so that the template will fit on the bottom of the upper cabinet. If upper cabinet has a recessed frame, trim the template so it fits inside the recessed area. Align the centerline of the upper cabinet template with the centerline of the wall template, then securely tape or tack the upper cabinet template in place. See Figure 22.

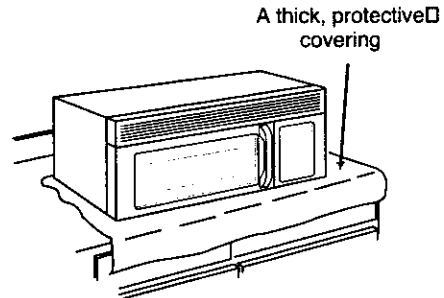

Figure 20

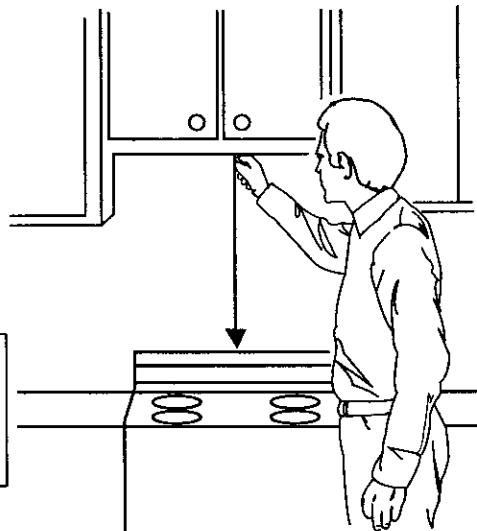

Figure 21

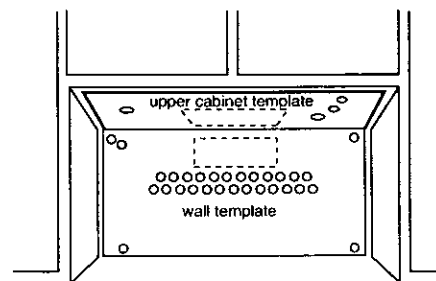

Figure 22

Installation

STEP 4: PREPARE THE WALL AND UPPER CABINET FOR INSTALLATION

WARNING

BE VERY CAREFUL WHEN DRILLING HOLES INTO THE WALL.
Electrical wires could be concealed behind the wall covering
and if the drill hits them you could get an electric shock.

DRILL THE HOLES IN THE WALL AND UPPER CABINET.

1. Find the points on the wall template labeled **D, E, F, and G**. Drill a 3/16" diameter hole at any points that are over a wall stud. Drill a 3/4" diameter hole at any points over drywall.
2. Locate the wall stud closest to the center of the areas marked **H and I** on the wall template. Drill 3/16" holes into the wall stud in each of the areas. If a wall stud is not located within these areas, drill 3/4" diameter holes nearest to the center of the areas as possible.
If there is not a wall stud within the areas marked H and I, or behind points marked D, E, F, and G, DO NOT install microwave oven. (Consult building inspector.) There must be at least one stud in those areas.
3. Drill a 3/8" hole at points **J, K, and N** on the upper cabinet template.
NOTE: If the bottom of the upper cabinet is recessed 3/4" or more, you will need 2"x2" filler blocks (not included) to provide additional support for the bolts. See Figure 23.
 - Mark the center of each filler block and drill a 3/8" diameter hole at the marks.
 - Align filler blocks over the two openings in the top of the microwave oven cabinet and attach to cabinet with masking tape. See Figure 24.
4. Cut or drill a 2" diameter hole at the area marked **M**.
Power supply cord hole on the upper cabinet template. If the upper cabinet is metal, you will need to cover the edge of the hole with the power supply cord bushing (supplied) to prevent damage to the cord from the rough metal edge.

WARNING

YOU MUST COVER THE EDGE OF THE POWER SUPPLY CORD HOLE IN A METAL CABINET WITH THE POWER SUPPLY CORD BUSHING. FAILURE TO DO SO COULD RESULT IN DAMAGE TO THE CORD AND ELECTRIC SHOCK.

5. Cut out the venting areas (with the saber saw):
 - Roof-Vented: cut out the shaded area marked **L** on the upper cabinet template.
 - Wall-Vented: cut out the shaded area marked **O** on the wall template.
 - Room-Vented: go to STEP 5, INSTALLING THE MOUNTING PLATE, located on next page.
6. Complete whichever venting system you have chosen.
Use caulking compound to seal the exterior wall or roof opening around the wall cap or roof cap.

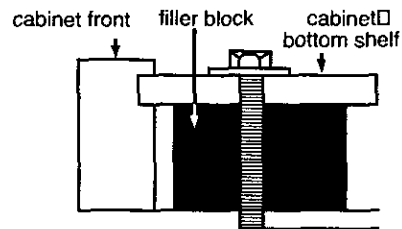

Figure 23

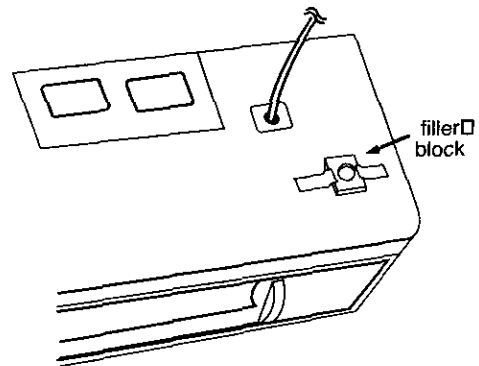

Figure 24

Installation

STEP 5: INSTALL THE MOUNTING PLATE

1. Remove the templates from upper cabinet and wall.

NOTE: If you are venting the oven through the wall, be sure you align the damper/connector on the rear of the mounting plate with the 3 1/4"x10" duct. Be sure the damper moves freely. See Figure 26.

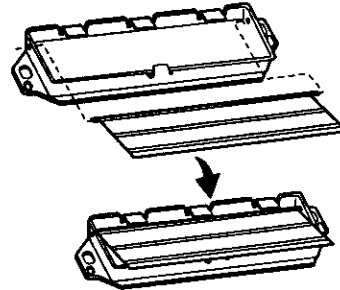

Figure 25

2. Prepare the toggle bolts by putting the bolts through the corner holes and attaching a spring toggle head to the end of each toggle bolt as shown in Figure 27.

3. Place the mounting plate against the wall and match the screw holes. See Figure 28.

NOTE: Be sure to leave at least one wall-thickness of space between the head of the toggle bolt and the spring toggle head so that the spring toggle can open on the inside of the wall, as shown in Figure 29. You may have to pull out slightly on the bracket to put tension on the toggles.

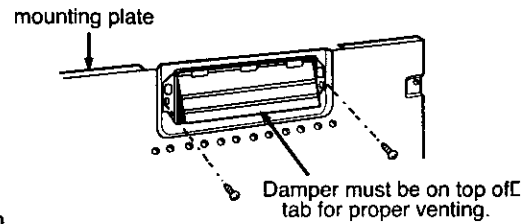

Figure 26 □ □

4. Locate the stud holes (3/16") and insert the lag screws through the mounting plate and into the holes. See Figure 30.

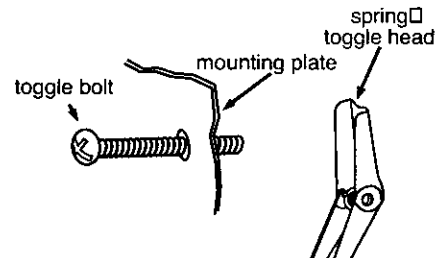

Figure 27 □ □ □

5. Insert the toggle bolts through the drywall holes (3/4"). Tighten the toggle bolts.

6. Slide the washer onto the lock pin and place inside the upper cabinet for future use as directed on page 44. See Figure 31.

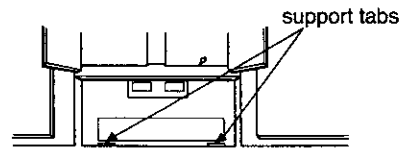

Figure 28 □

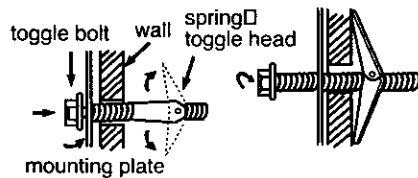

Figure 29

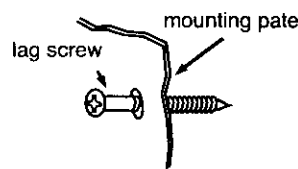

Figure 30

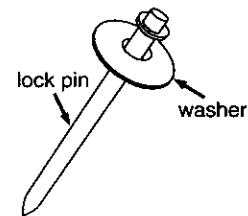

Figure 31

Installation

STEP 6: ATTACH THE OVEN TO THE WALL

WARNING

**You will need two people to lift this microwave.
Failure to use more than one person could
result in personal injury.**

1. Carefully lift microwave oven and hang it on support tabs (See Figure 28 at the bottom of the mounting plate. Reaching through upper cabinet, thread power supply cord through the power supply cord hole in the bottom of the upper cabinet. See Figure 32.

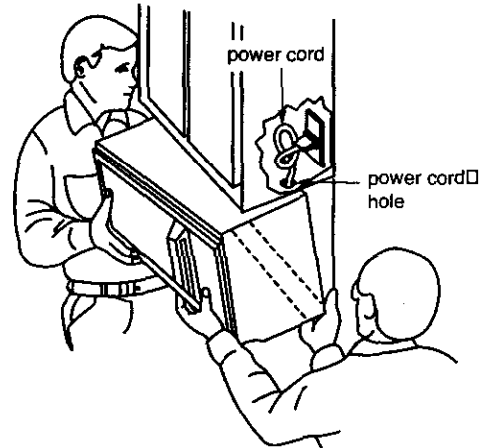

Figure 32

2. Rotate the microwave upward so the top of oven is against the bottom of the upper cabinet or cabinet frame.

3. Drop the lock pin and washer assembly into hole N (left side hole) and push the pin down as far as it will go. See Figure 33.

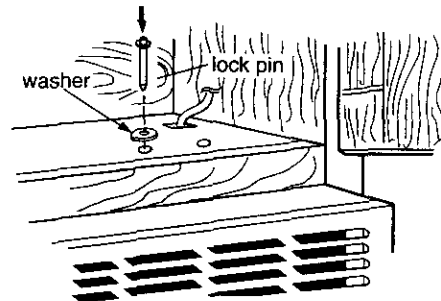

Figure 33

4. Place washers over two 1/4"x3" bolts. Then insert a bolt down through each hole in the upper cabinet bottom. Tighten the bolts until the gap between the upper cabinet and microwave oven is closed. See Figure 34.

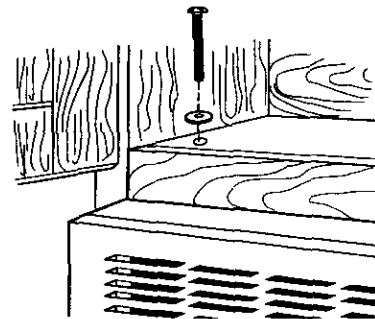

Figure 34

5. Remove the lock pin and washer.
If wall-vented or room-vented installation is used, skip to No. 8.

Installation

STEP 6: ATTACH THE OVEN TO THE WALL

6. Roof-vented installation: Align the damper/duct connector with the vent on top of the microwave oven. Damper should be on top of tab. Use two tapping screws (bright-colored) to attach damper/duct connector to the microwave oven. See Figure 36.

NOTE: Damper/duct connector must be attached to microwave oven **after** microwave oven is installed.

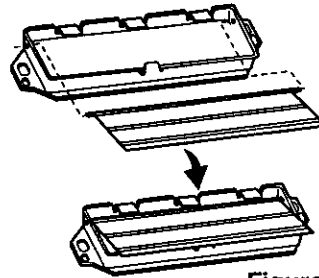

Figure 35

7. Roof venting installation: Install ductwork through the vent opening in the upper cabinet. Complete the venting system through the roof according to the method needed. See Figure 37. See PREPARE THE VENTING SYSTEM, STEP 2. Use caulking gun to seal the exterior roof opening around the exhaust cap. See Figure 6.

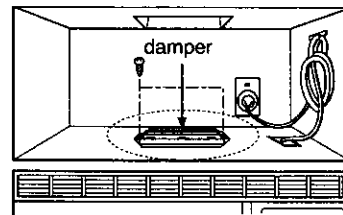

Figure 36

8. Use the power supply cord clamp to bundle the power supply cord. Install the power supply cord clamp, using a screw as shown in Figure 37, to inside of the cabinet.

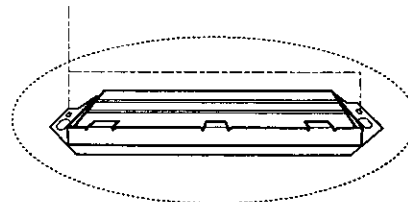

Figure 36 Detail

9. Grasp filter screen with one hand holding the ring and the other hand holding the opposite end. Insert the end of the filter screen without ring into the opening and slide towards the side of the microwave oven. Insert ring end of filter screen into the opening and slide entire screen towards the center of the microwave until screen is securely in position. Repeat for other filter screen. See Figure 38.

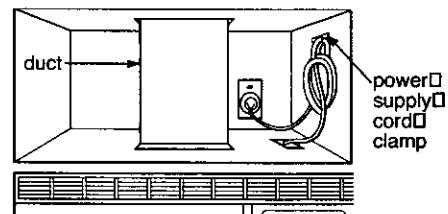

Figure 37

10. Plug in the power supply cord.

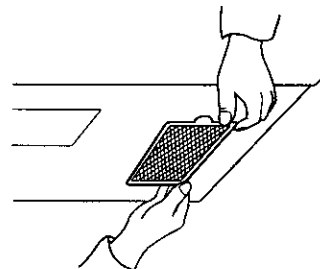

Figure 38

11. Read your Owner's Manual, then check the operation of your microwave oven.

Warranty

Amana[®] VENT HOOD MICROWAVE OVEN FULL ONE YEAR WARRANTY FULL FIVE YEAR WARRANTY ON MAGNETRON TUBE

FIRST YEAR

Amana Appliances will replace, including related labor and travel, any part (f.o.b. Amana, Iowa) which proves to be defective as to workmanship or materials.

SECOND THRU FIFTH YEAR

Amana Appliances will repair or replace, including related labor and travel, a magnetron tube, (f.o.b. Amana, Iowa), which proves defective as to workmanship or materials.

OWNER'S RESPONSIBILITIES:

- Provide proof of purchase. (Sales Receipt)
- Provide normal care and maintenance, including cleaning as instructed in owner's manual.
- Replace owner replaceable items where directions appear in the Owner's Manual.
- Make product accessible for service.
- Pay for premium service costs for service outside servicer's normal business hours.
- Pay for service calls related to product installation and customer education.

ITEMS NOT COVERED:

- Normal product maintenance and cleaning.
- Lost or broken air filters.
- Light bulbs.
- Damages which occur in shipment.
- General rebuilding or refurbishing that is not a legitimate warranty repair.
- Failures caused by:
 - Unauthorized service.
 - Grease or other material buildup due to improper cleaning or maintenance.
 - Accidental or intentional damage.
 - Connection to an improper power supply.
 - Acts of God.
 - Operating an empty oven.
 - Use of improper pans, containers, or accessories that causes damage to the product.

WARRANTY LIMITATIONS:

- Begins at date of original purchase.
- Applies to product used for NORMAL food preparation.
- Applies to product used within the United States or in Canada if product has appropriate agency listing when shipped from the factory.
- Service must be performed by an authorized Amana servicer.

WARRANTY IS VOID IF:

- Serial plate is defaced.
- Product is altered by user.
- Product is not installed or used according to manufacturer's instructions.
- Product is used on a commercial, rental, or leased, basis.

IN NO EVENT SHALL AMANA APPLIANCES BE LIABLE FOR INCIDENTAL OR CONSEQUENTIAL DAMAGES*

*This warranty gives you specific legal rights and you may have others which vary from state to state. For example, some states do not allow the exclusion or limitation of incidental or consequential damages so this exclusion may not apply to you.

For answers to questions regarding the above or to locate an authorized Amana servicer, contact:

Amana Appliances
2800 220th Trail
PO Box 8901
Amana, Iowa 52204-0001
USA
1-800-843-0304 inside U.S.A.
1-319-622-5511 outside U.S.A.