



**Amana**<sup>®</sup>  
 BUILT BETTER THAN IT HAS TO BE™

# Owner's Manual

*Covering model ACM0720A*

## Electric Microwave

Keep instructions for future reference.  
 Be sure manual stays with microwave.

### Contents

Important Safety Information .....	3
Installation .....	5
Other Helpful Information .....	6
Cooking Utensils.....	8
Feature Diagram .....	9
Operating Instructions .....	10
Care and Cleaning .....	15
Heating or Reheating Guide .....	16
Fresh Vegetable Chart.....	17
Troubleshooting.....	18
Amana Warranty .....	19

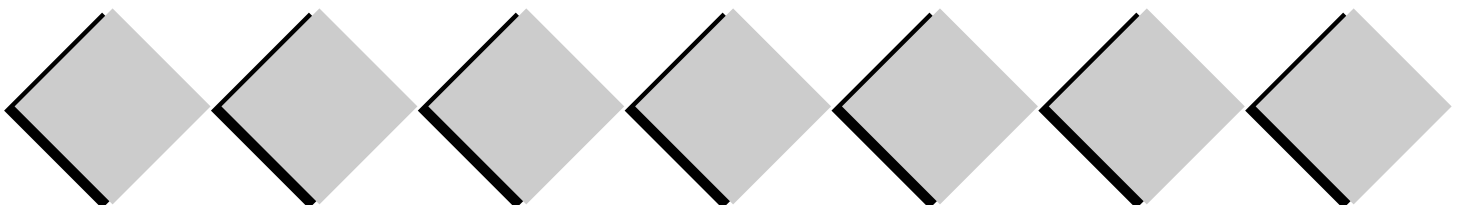

# Thank you for buying an Amana Microwave!

Please take the time to complete the registration card and return promptly. If the registration card is missing, call Amana Consumer Affairs Department. When contacting Amana, provide product information from serial plate:

Model Number \_\_\_\_\_  
Manufacturing (P) Number \_\_\_\_\_  
Serial Number (S/N) \_\_\_\_\_  
Purchase Date \_\_\_\_\_  
Dealer Name \_\_\_\_\_  
Dealer Address \_\_\_\_\_  
Dealer Phone \_\_\_\_\_

**Keep this manual and your sales receipt together in a safe place** for future reference or if warranty service is required.

For answers to questions or to locate an authorized servicer, call **1-800-NAT-LSVC(1-800-628-5782) inside USA or 319-622-5511 outside USA.** **Warranty service must be performed by an authorized servicer.** Amana Appliances also recommends contacting an authorized servicer if service is required after warranty expires.

*Questions on cooking, cleaning or usage?*

Refer to

Product Assistance at **www.amana.com**

or

call Consumer Affairs at **1-800-843-0304**

## Asure™ Extended Service Plan

Amana Appliances offers long-term service protection for this new microwave. Asure™ Extended Service Plan, covering functional parts, labor, and travel charges, is specially designed to supplement a strong warranty. Call 1-800-528-2682 for information.

## Parts and Accessories

Purchase replacement part and additional accessories by phone. To order accessories for your Amana product, call 1-800-843-0304 inside USA or 319-622-5511 outside USA.

## Save Time and Money

If something seems unusual, please check "Troubleshooting" section, which is designed to help you solve problems before calling service. If you have a question, call us at (800) 843-0304 or write us at:

Consumer Affairs Department  
Amana Appliances  
2800-220th Trail  
Amana, Iowa 52204

Remember to include model number of your appliance and your phone number.

## What You Need to Know About Safety Instructions

Warning and Important Safety Instructions appearing in this manual are not meant to cover all possible conditions and situations that may occur. Common sense, caution, and care must be exercised when installing, maintaining, or operating microwave.

Always contact your dealer, distributor, service agent, or manufacturer about problems or conditions you do not understand.

## Recognize Safety Symbols, Words, Labels

 **DANGER**

**DANGER** - Immediate hazards which WILL result in severe personal injury or death.

 **WARNING**

**WARNING** - Hazards or unsafe practices which COULD result in severe personal injury or death.

 **CAUTION**

**CAUTION** - Hazards or unsafe practices which COULD result in minor personal injury or product or property damage.

# IMPORTANT SAFETY INFORMATION

## CAUTION

To avoid risk of personal injury or property damage, observe the following:

1. Be certain to place the front surface of the door three inches away or more from the countertop edge to avoid accidental tipping of the appliance in normal usage.
2. For the most accurate programming of the electronic units, touch the center of each pad securely. Do not touch several pads at one time or touch between pads. A beep sound should be heard with each touch when a pad is touched correctly.
3. Do not hit or strike the control with objects such as silverware, utensils, etc. Breakage may occur.
4. Be careful when taking the cooking utensils out of the oven. Some dishes absorb heat from the cooked food and may be hot.
5. Do not rinse cooking utensils by immediately placing them into water just after cooking. This may cause breakage. Allow the turntable to cool.
6. Use only specific glass utensils. See cooking utensils section in this manual.
7. Do not operate the oven empty. Either food or water should always be in the oven during operation to absorb microwave energy.
8. Do not use your microwave oven to dry newspapers or clothes. They can catch fire.
9. Use only thermometers approved for microwave oven cooking.
10. Be certain the turntable is in place when you operate the oven.
11. Pierce the skin of potatoes, whole squash, apples, or any fruit or vegetable which has a skin covering before cooking.
12. Never use your microwave oven to cook eggs in the shell. Pressure can build up inside the shell, causing it to burst.
13. Do not pop popcorn, except in a microwave-safe container or commercial package designed especially for microwave ovens. Never try to pop popcorn in a paper bag not designed for microwave oven use. Overcooking may result in smoke and fire. Do not repop unpopped kernels. Do not reuse popcorn bags.

## PRECAUTIONS TO AVOID POSSIBLE EXPOSURE TO EXCESSIVE MICROWAVE ENERGY

- A. **DO NOT** attempt to operate this oven with door open since open door operation can result in harmful exposure to microwave energy. It is important not to defeat or tamper with safety interlocks.
- B. **DO NOT** place any object between oven front face and door to allow soil or cleaner residue to accumulate on sealing surfaces.
- C. **DO NOT** operate oven if it is damaged. It is particularly important that oven door close properly and that there is no damage to:
  1. Door (bent),
  2. Hinges and latches (broken or loosened),
  3. Door seals and sealing surfaces.
- D. Oven should not be adjusted or repaired by anyone except properly qualified service personnel.

## SAVE THESE INSTRUCTIONS

# IMPORTANT SAFETY INFORMATION

## Recognize this symbol as a SAFETY message

### WARNING

To reduce the risk of burns, electric shock, fire, injury to persons, or exposure to excessive microwave energy:

1. Read all instructions before using the appliance.
2. Read and follow the specific PRECAUTIONS TO AVOID POSSIBLE EXPOSURE TO EXCESSIVE MICROWAVE ENERGY found on page 3 of this manual.
3. This appliance must be grounded. Connect only to properly grounded outlet. See GROUNDING INSTRUCTIONS found on page 5 of this manual.
4. Install or locate this appliance only in accordance with the provided installation instructions.
5. Some products such as whole eggs and sealed containers – for example, closed glass jars – may explode and should not be heated in this oven.
6. Use this appliance only for its intended use as described in the manual. Do not use corrosive chemicals or vapors in this appliance. This type of oven is specifically designed to heat, cook, or dry food. It is not designed for industrial or laboratory use.
7. As with any appliance, close supervision is necessary when used by children.
8. Do not operate this appliance if it has a damaged cord or plug, if it is not working properly, or if it has been damaged or dropped.
9. This appliance should be serviced only by qualified service personnel. Contact the nearest authorized service facility for examination, repair, or adjustment.
10. Do not cover or block any openings on the appliance.
11. Do not store this appliance outdoors. Do not use this product near water - for example, near a kitchen sink, in a wet basement, or near a swimming pool, and the like.
12. Do not immerse cord or plug in water.
13. Keep cord away from heated surfaces.
14. Do not let cord hang over the edge of table or counter.
15. When cleaning surfaces of door and oven that comes together on closing the door, use only mild, non abrasive soaps or detergents applied with a sponge or soft cloth.
16. Do not heat any type of baby bottles or baby food. Uneven heating may occur and could cause personal injury.
17. Avoid heating small-necked containers such as syrup bottles.
18. Avoid using corrosive and vapors, such as sulfide and chloride.
19. Liquids heated in certain shaped containers (especially cylindrical-shaped containers) may become overheated. The liquid may splash out with a loud noise during or after heating or when adding ingredients (instant coffee, etc.), resulting in harm to the oven and possible injury. In all containers, for best results, stir the liquid several times before heating. Always stir liquid several times between reheatings.

### CAUTION

To reduce the risk of fire in the oven cavity:

- a. Do not overcook food. Carefully attend appliance if paper, plastic, or other combustible materials are placed inside the oven to facilitate cooking.
- b. Remove wire twist-ties from paper or plastic bags before placing bag in oven.
- c. If materials inside the oven should ignite, **KEEP OVEN DOOR CLOSED**, turn oven off, and disconnect the power cord or shut off power at the fuse or circuit breaker panel.
- d. Do not use the cavity for storage purposes. Do not leave paper products, cooking utensils, or food in the cavity when not in use.

## SAVE THESE INSTRUCTIONS

## **⚠ WARNING**

To avoid risk of electrical shock or death, this oven must be earthed.

## **⚠ WARNING**

To avoid risk of electrical shock or death, do not alter the plug.

## **A. GROUNDING INSTRUCTIONS**

This appliance must be grounded. In the event of an electrical short circuit, grounding reduces the risk of electric shock by providing an escape wire for the electric current. This appliance is equipped with a cord having a grounding wire with a grounding plug. The plug must be plugged into an outlet that is properly installed and grounded.

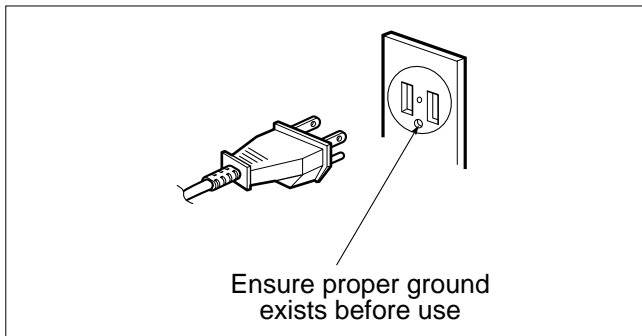

## **B. CIRCUITS**

For safety purposes this oven must be plugged into a 15 or 20 Amp circuit. No other electrical appliances or lighting circuits should be on this line. If in doubt, consult a licensed electrician.

## **C. VOLTAGE**

The voltage used at the wall receptacle must be the same as specified on the oven name plate located inside oven door. Use of a higher voltage is dangerous and may result in a fire or other type of accident causing oven damage. Low voltage will cause slow cooking. In case your microwave oven does not perform normally in spite of proper voltage, remove and reinsert the plug.

## **D. PLACEMENT OF THE OVEN**

Your microwave oven can be placed easily in your kitchen, family room, or anywhere else in your home. Place the oven on a flat surface such as a kitchen countertop or a specially designed microwave oven cart. Do not place oven above a gas or electric range. Free air flow around the oven is important.

## **E. DO NOT BLOCK AIR VENTS**

All air vents should be kept clear during cooking. If air vents are covered during oven operation the oven may overheat. In this case, a sensitive thermal safety device automatically turns the oven off. The oven will be inoperable until it has cooled sufficiently.

## **F. RADIO INTERFERENCE**

1. Microwave oven operation may interfere with TV or radio reception.
2. When there is interference, it may be reduced or eliminated by taking the following measures:
  - a. Clean the door and the sealing surfaces of the oven.
  - b. Reorient the receiving antenna of radio or television.
  - c. Relocate the microwave oven in relation to the TV or radio.
  - d. Move the microwave oven away from the receiver.
  - e. Plug the microwave oven into a different outlet so that microwave oven and receiver are on different branch circuits.

## **G. UNPACKING OVEN**

- Inspect oven for damage such as dents in door or inside oven cavity.
- Report any dents or breakage to source of purchase immediately.  
**Do not attempt to use oven if damaged.**
- Remove all materials from oven interior.
- If oven has been stored in extremely cold area, wait a few hours before connecting power.

# Other Helpful Information

---

## GETTING THE BEST RESULTS FROM YOUR MICROWAVE OVEN

**Keep an eye on things.** The instructions in this book have been formulated with great care, but your success in preparing food depends, of course, on how much attention you pay to the food as it cooks. Always watch your food while it cooks. Your microwave oven is equipped with a light that turns on automatically when the oven is in operation so that you can see inside and check the progress of your recipe. Directions given in recipes to elevate, stir, and the like should be thought of as the minimum steps recommended. If the food seems to be cooking unevenly, simply make the necessary adjustments you think appropriate to correct the problem.

**Factors affecting cooking times.** Many factors affect cooking times. The temperature of ingredients used in a recipe makes a big difference in cooking times. For example, a cake made with ice-cold butter, milk, and eggs will take considerably longer to bake than one made with ingredients that are at room temperature. All of the recipes in this book give a range of cooking times. In general, you will find that the food remains under-cooked at the lower end of the time range, and you may sometimes want to cook your food beyond the maximum time given, according to personal preference. The governing philosophy of this book is that it is best for a recipe to be conservative in giving cooking times. While undercooked food may always be cooked a bit more, overcooked food is ruined for good. Some of the recipes, particularly those for bread, cakes, and custard, recommend that food be removed from the oven when they are slightly undercooked. This is not a mistake. When allowed to stand, usually covered, these foods will continue to cook outside of the oven as the heat trapped within the outer portions of the foods gradually travels inward. If the foods are left in the oven until they are cooked all the way through, the outer portions will become overcooked or even burnt.

As you gain experience in using your microwave oven, you will become increasingly skillful in estimating both cooking and standing times for various foods.

## SPECIAL TECHNIQUES IN MICROWAVE COOKING

**Browning:** Meats and poultry that are cooked fifteen minutes or longer will brown lightly in their own fat. Foods that are cooked for a shorter period of time may be brushed with a browning sauce to achieve an appetizing color. The most commonly used browning sauces are Worcestershire sauce, soy sauce, and barbecue sauce. Since relatively small amounts of browning sauces are added to foods, the original flavor of recipes is not altered.

**Covering:** A cover traps heat and steam and causes food to cook more quickly. You may either use a lid or microwave cling-film with a corner folded back to prevent splitting.

**Covering with waxed paper:** Waxed paper effectively prevents spattering and helps food retain some heat. Since it makes a looser cover than a lid or cling-film, it allows the food to dry out slightly.

**Wrapping in waxed paper or paper towel:** Sandwiches and many other foods containing prebaked bread should be wrapped prior to microwaving to prevent drying out.

**Arranging and spacing:** Individual foods such as baked potatoes, small cakes, and hors d'oeuvres will heat more evenly if placed in the oven and equal distance apart, preferably in a circular pattern. Never stack foods on top of one another.

**Stirring:** Stirring is one of the most important of all microwaving techniques. In conventional cooking, foods are stirred for the purpose of blending. Microwaved foods, however, are stirred in order to spread and redistribute heat. Always stir from the outside towards the center as the outside food heats first.

**Turning over:** Large, tall foods such as roasts and whole chickens should be turned so that the top and bottom will cook evenly. It is also a good idea to turn cut-up chicken and chops.

**Placing thicker portions near the edge:** Since microwaves are attracted to the outside portion of foods, it makes sense to place thicker portions of meat, poultry and fish to the outer edge of the baking dish. This way, thicker portions will receive the most microwave energy and the foods will cook evenly.

# Other Helpful Information

---

**Elevating:** Thick or dense foods are often elevated so that microwaves can be absorbed by the underside and center of the foods.

**Piercing:** Foods enclosed in a shell, skin, or membrane are likely to burst in the oven unless they are pierced prior to cooking. Such foods include both yolks and whites of eggs, clams and oysters, and many whole vegetables and fruits.

**Testing if cooked:** Because foods cook so quickly in a microwave oven, it is necessary to test food frequently. Some foods are left in the microwave until completely cooked, but most foods, including meats and poultry, are removed from the oven while still slightly undercooked and allowed to finish cooking during standing time. The internal temperature of foods will rise between 5°F (3°C) and 15°F (8°C) during standing time.

**Standing time:** Foods are often allowed to stand for 3 to 10 minutes after being removed from the microwave oven. Usually the foods are covered during standing time to retain heat unless they are supposed to be dry in texture (some cakes and biscuits, for example). Standing allows foods to finish cooking and also helps flavors to blend and develop.

## HOW FOOD CHARACTERISTICS AFFECT MICROWAVE COOKING

**Density of foods:** Light, porous food like cakes and breads cook more quickly than heavy, dense foods such as roasts and casseroles. You must take care when microwaving porous foods that the outer edges do not become dry and brittle.

**Height of foods:** The upper portion of tall foods, particularly roasts, will cook more quickly than the lower portion. Therefore, it is wise to turn tall foods during cooking, sometimes several times.

**Moisture content of foods:** Since the heat generated from microwaves tends to evaporate moisture, relatively dry foods such as roasts and some vegetables should either be sprinkled with water prior to cooking or covered to retain moisture.

**Bone and fat content of foods:** Bones conduct heat and fat cooks more quickly than meat. Therefore, care must be taken when cooking bony or fatty cuts of meat that the meats do not cook unevenly and do not become overcooked.

**NOTE:** It is a common misconception that microwaves cook food from the inside out. This comes from heating filled pastries with a high sugar content, like jelly doughnuts. The pastry is cool but the filling is very hot! If you cook a chicken or a roast, you'll see the outside is cooked first.

**Shape of foods:** Microwaves penetrate only about 1 inch (2.5cm) into foods; the interior portion of thick foods is cooked as the heat generated on the outside travels inward. In other words, only the outer edge of any food is actually cooked by microwave energy; the rest is cooked by convection.

It follows then that the worst possible shape for a food that is to be microwaved is a thick cube. The corners will burn long before the center is even warm. Round, thin, and ring shaped foods cook most successfully in the microwave.

**Quantity of foods:** The number of microwaves in your oven remains constant regardless of how much food is being cooked. Therefore, the more food you place in the oven, the longer the cooking time. Remember to decrease cooking times by at least one-third when halving a recipe.

# Cooking Utensils

---

## CAUTION

To avoid risk of personal injury or property damage, do not use stoneware, aluminum foil, metal utensils, or metal trimmed utensils in the oven.

## MICROWAVE-SAFE UTENSILS

**Never use metal or metal-trimmed utensils in your microwave oven:** Microwaves cannot penetrate metal. They will bounce off any metal object in the oven and cause arcing, an alarming phenomenon that resembles lightning. Most heat-resistant non-metallic cooking utensils are safe for use in your microwave oven. However, some may contain materials that render them unsuitable as microwave cookware. If you have any doubts about a particular utensil, there is a simple way to find out if it can be used in your microwave oven.

**Testing utensils for microwave use:** Place the utensil in question next to a glass bowl filled with water in the microwave oven. Microwave at power HIGH for 1 minute. If the water heats up but the utensil remains cool to the touch, the utensil is microwave-safe. However, if the water does not change temperature but the utensil becomes warm, microwaves are being absorbed by the utensil and it is not safe for use in the microwave oven. You probably have many items on hand in your kitchen that can be used as cooking equipment in your microwave oven. Just read through the following checklist.

**1. Dinner plates:** Many kinds of dinner-ware are microwave-safe. If in doubt, consult the manufacturer's literature or perform the microwave test, above.

**2. Glassware:** Glassware that is heat-resistant is microwave-safe. This includes all brands of oven-tempered glass cookware. However, do not use delicate glassware, such as tumblers or wine glasses, as these might shatter as the food warms.

**3. Paper: Paper plates and containers are convenient and safe to use in your microwave oven, provided the cooking time is short and foods to be cooked are low in fat and moisture.** Paper towels are also very useful for wrapping foods and for lining baking trays in which greasy foods, such as bacon, are cooked. In general, avoid colored paper products as the color may run.

**4. Plastic storage containers:** These can be used to hold foods that are to be quickly reheated. However, they should not be used to hold foods that will need considerable time in the oven as hot foods will eventually warp or melt plastic containers.

**5. Plastic cooking bags:** These are microwave-safe provided they are specially made for cooking. However, **be sure to make a slit in the bag** so that steam can escape. Never use ordinary plastic bags for cooking in your microwave oven, as they will melt and rupture.

**6. Plastic microwave cookware:** A variety of shapes and sizes of microwave cookware is available. For the most part, you can probably cook with items you already have on hand rather than investing in new kitchen equipment.

**7. Pottery, stoneware, and ceramic:** Containers made of these materials are usually fine for use in your microwave oven, but they should be tested to be sure.



# Feature Diagram

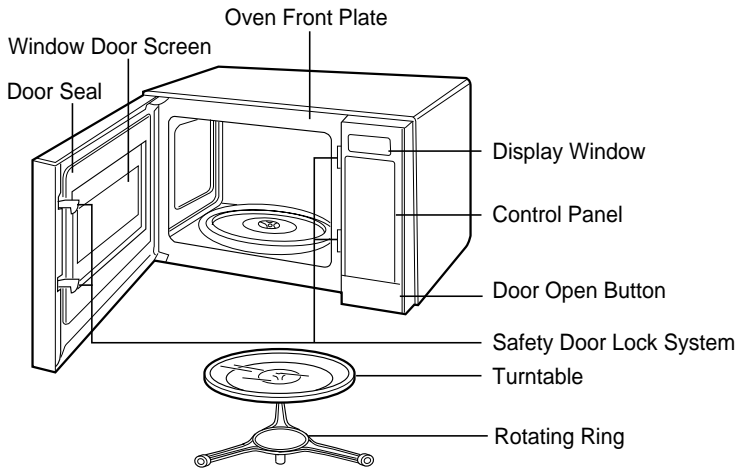

Your oven will be packed with the following materials:

- Glass Turntable ..... 1 each
- Owner's Manual & Cooking Guide..... 1 each
- Rotating Ring..... 1 each

This microwave oven is designed for household use only. It is not recommended for commercial purposes.

# Control Panel

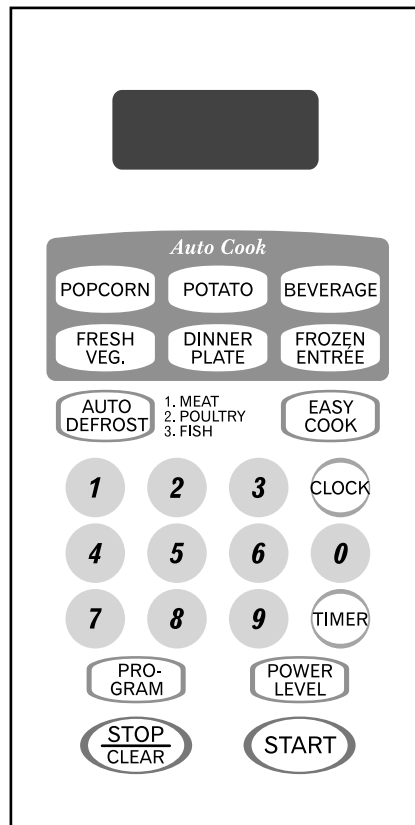

**NOTE:** A beep sounds when a pad on the control panel is touched to indicate setting has been entered.

# Operating Instructions

## SETTING CLOCK

This is a 12 hour clock. When your oven is plugged in for the first time or when power resumes after a power interruption, the numbers in the display reset to 0.

**Example: To set 11:11**

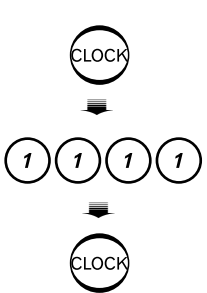

1. Touch **CLOCK**.
2. Enter the time by using the number key pads. [1], [1], [1], and [1].
3. Touch **CLOCK**. The clock starts counting.

## TIMER

You can use the **TIMER** of your oven for purposes other than food cooking.

**Example: To set the timer.**

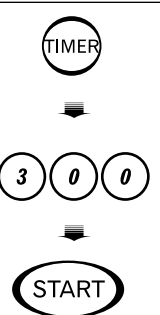

1. Touch **TIMER** pad.
2. Touch **3, 0, 0**.
3. Touch **START** pad.

## EASY COOK

A time-saving pad, this simplified control lets you quickly set and start microwave cooking without the need to touch **START**.

**Example: To set EASY COOK for 2 minutes.**



Touch **EASY COOK** 4 times. The oven begins cooking and display shows time counting down.

### NOTE:

If you touch **EASY COOK**, it will add 30 seconds up to 3 minutes; after 3 minutes, every touch will add 1 minute up to 99 min 99 seconds.

## TIME COOK

This function allows you to cook food for a desired time. And in order to give you the best results, there are 10 power level settings in addition to HI-POWER because many foods need slower cooking (at less than HI-POWER).

**Example: To cook food on 80% Power(Power8) for 5 minutes 30 seconds**

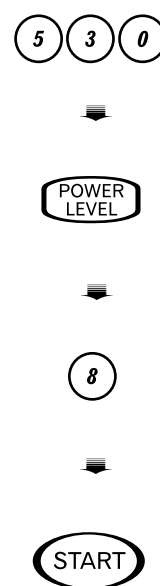

1. Enter 5 minutes 30 seconds by touching [5], [3], and [0].
2. Touch **POWER LEVEL**. P-HI appears in the display. This is to tell you that the oven is set on HI unless a different power setting is chosen.
3. Touch **8**. To select power level 80%. Display shows **P-80**.
4. Touch **START**.

When the cooking time is over, two short and one long tone sounds. The word **End** shows in the display window. Then the oven shuts itself off.

### NOTE :

If you do not select the power level, the oven will operate at power HIGH. To set HI-POWER cooking, skip steps 2 & 3 above.

# Operating Instructions

## MULTI-STAGE TIME COOK

For Multi-Stage cooking, touch PROGRAM and repeat Time Cook steps 1-3 on previous page before touching the START pad for additional Time and Power program you want to add. Auto Defrost can be programmed before the first stage to defrost first and then cook.

## MICROWAVE POWER LEVELS

Your microwave oven is equipped with eleven power levels to give you maximum flexibility and control over cooking. The table below will give you some idea of which foods are prepared at each of the various power levels.

### MICROWAVE POWER LEVEL CHART

Power Level	Use
High	*Boiling water. *Making candy. *Cooking poultry pieces, fish, & vegetables. *Cooking tender cuts of meat.
9	*Reheating rice, pasta, & vegetables.
8	*Reheating prepared foods quickly. *Reheating sandwiches.
7	*Cooking egg, milk and cheese dishes. *Cooking cakes, breads. *Melting chocolate.
6	*Cooking veal. *Cooking whole fish. *Cooking puddings and custard.
5	*Cooking ham, whole poultry, lamb. *Cooking rib roast, sirloin tip.
4	*Thawing meat, poultry and seafood.
3	*Cooking less tender cuts of meat. *Cooking pork chops, roast.
2	*Taking chill out of fruit. *Softening butter.
1	*Keeping casseroles and main dishes warm. *Softening butter and cream cheese.
	*Standing time. *Independent timer.

## CHILD LOCK

This is a unique safety feature that prevents unwanted oven operation such as used by children. Once the child lock is set, no cooking can take place. The Child Lock feature is also useful when cleaning the control panel. Child Lock prevents accidental programming when wiping the control panel.

### To set the child lock



1. Touch **STOP/CLEAR**.



2. Touch and hold **0** until “L” appears in the display and two beeps are heard. “L” remains in the display.

When child lock was already set, if you touch START or one touch cook pad, display shows “L”. Then you can cancel the child lock according to below procedure.

### To cancel the child lock



Touch and hold **0** until “L” disappears in the display. The time of day returns to the display window.

# Operating Instructions

## AUTO COOK

Auto Cook made easy! Your oven's menu has been preprogrammed to cook food automatically. Tell the oven what you want. Then let your microwave oven cook your selections.

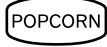
<b>Example: To cook popcorn(3.5 oz.), simply follow the step below</b>	
	<p>*Place popcorn in the oven and close the door.</p> <p>Touch <b>POPCORN</b> once.</p> <p>The oven begins the cooking you selected without the need to touch START. Be sure to close the door before selecting categories.</p>

## AUTO COOK CHART

Key	Touch	Serving size	Directions
<b>POPCORN</b>	one Time two Times three Times	3.5 oz. 3.0 oz. 1.75 oz.	<ul style="list-style-type: none"> <li>Follow package instructions.</li> <li>Use popcorn package which is made especially for microwave cooking.(Refer to 8 page)</li> <li>Do not try to pop unpopped kernels.</li> <li>Heat only 1 package at a time.</li> <li>Do not leave the microwave oven unattended while popping popcorn.</li> </ul>
<b>POTATO</b>	one Time two Times three Times four Times	1 2 3 4	<ul style="list-style-type: none"> <li>8-10 oz. per potato.</li> <li>Place in center of the turntable tray on paper towel.</li> <li>Pierce potato several times with fork.</li> <li>After cooking, let stand for 5 minutes.</li> <li>No cover.</li> </ul>
<b>BEVERAGE</b>	one Time two Times	1 cup 2 cups	<ul style="list-style-type: none"> <li>240ml per cup.</li> <li>Use mug or microwave-safe cup.</li> <li>Stir after reheating.</li> </ul>
<b>FRESH VEGETABLE</b>	one Time two Times three Times four Times	1 cup 2 cups 3 cups 4 cups	<ul style="list-style-type: none"> <li>Prepare vegetable(wash and cut into 1/2-inch pieces).</li> <li>Cover with plastic wrap and vent.</li> <li>Most vegetables need 2 to 3 minutes standing time to finish cooking.</li> <li>1 &amp; 2 cups - Add 2 tablespoon water.</li> <li>3 &amp; 4 cups - Add 4 tablespoon water.</li> </ul>
<b>DINNER PLATE</b>	one Time two Times	1 serving 2 servings	<ul style="list-style-type: none"> <li>Arrange food on turntable tray.</li> <li>Place meaty portions and bulky vegetable to the outside of the plate.</li> <li>Cover with plastic wrap and vent.</li> <li>After cooking, let stand for 2 minutes.</li> </ul>
<b>FROZEN ENTRÉE</b>	one Time	10 oz.	<ul style="list-style-type: none"> <li>Follow the package instructions.</li> <li>Example of one frozen entree is Lasagna with Meat Sauce, Chicken with Rice, Sliced Turkey Breast with Rice and Vegetable.</li> </ul>

# Operating Instructions

## AUTO DEFROST

Three defrost sequences are preset in the oven. The defrost feature provides you with the best defrosting method for frozen foods. The cooking guide will show you which defrost sequence is recommended for the food you are defrosting.

With the Auto Defrost feature, the oven automatically sets the defrosting time and power levels for you.

The oven automatically determines required defrosting times for each food item according to the weight you enter.

For added convenience, the Auto Defrost includes a built-in beep mechanism that reminds you check, turn over, separate, or rearrange.

Three different defrosting levels are provided.

- 1 **MEAT** (dEF 1 )
- 2 **POULTRY** (dEF 2)
- 3 **FISH** (dEF 3)

\*You can select the category by touching the key once (MEAT), twice (POULTRY), or three times (FISH).



\*Available weight is 0.1~6.0 lbs (0.045~2.72 kg).

**Example: To defrost 1.2 lbs of ground beef.**





1. Touch **AUTO DEFROST**.  
dEF 1 appears in the display.



2. Enter the weight by touching [1] and [2].  
1.2 appears in the display.





3. Touch **START**.  
Defrosting starts.

### NOTE:

When you touch the START pad, the display changes to defrost time count down. The oven will beep during the DEFROST cycle. At each beep, open the door and turn, separate, or rearrange the food.

Remove any portions that have thawed.

Return frozen portions to the oven and touch START to resume the defrost cycle. **The oven will not STOP during the BEEP unless the door is opened.**

\*For best results, remove fish, shellfish, meat, and poultry from its original closed paper or plastic package (wrapper). Otherwise, the wrap will hold steam and juice close to the foods, which can cause the outer surface of the foods to cook.

\*Place foods in a shallow glass baking dish or on a microwave roasting rack to catch drippings.

\*Food should still be somewhat icy in the center when removed from the oven.

### AUTO WEIGHT DEFROST SEQUENCE LIST

Sequence	Food
dEF 1 <b>MEAT</b>	<b>BEEF</b> Ground beef, Round steak, Cubes for stew, Tenderloin steak, Pot roast, Rib roast, Rump roast, Chuck roast, Hamburger patty. <b>LAMB</b> Chop(1 inch thick), Rolled roast <b>PORK</b> Chop(1/2 inch thick), Hot dogs, Spareribs, Country-style ribs. Rolled roast, Sausage. <b>VEAL</b> Cutlets(1 lbs, 1/2 inch thick)
dEF 2 <b>POULTRY</b>	<b>POULTRY</b> Whole(under 4 lbs), Cut up Breasts (boneless) <b>CORNISH HENS</b> Whole <b>TURKEY</b> Breast(under 6 lbs)
dEF 3 <b>FISH</b>	<b>FISH</b> Fillets, Whole Steaks <b>SHELLFISH</b> Crab meat, Lobster tails, Shrimp, Scallops

# Operating Instructions

## ⚠ CAUTION

To avoid risk of property damage do not use aluminum foil in microwave oven.

### MEAT

1. No special techniques are required. The roast should be prepared and seasoned (if desired) as for any other conventional method. Meat should be thoroughly defrosted before cooking.
2. Place the meat on a microwave roasting rack or ovenproof plate and place on the turntable.
3. Cook according to the cooking chart (below), using the longer time for large meats and the shorter time for smaller meats. For thicker chops, use the longer time.
4. Turn the meat once halfway through the cooking time.
5. STAND for 5-10 minutes wrapped in foil after cooking. The standing time is very important as it completes the cooking process.
6. Ensure meat, especially pork, is thoroughly cooked before eating.

#### MEAT COOKING CHART

Cut	Microwave power	Cooking time per pound
<b>BEEF</b>		
Standing/Rolled Rib		
-Rare	8	10~12 minutes
-Medium	8	10~13 minutes
-Well-done	8	13~15 minutes
Ground Beef (to brown for casserole)	HIGH	9~12 minutes
Hamburgers, Fresh or defrosted (4 oz. each)		
-2 patties	HIGH(100%)	3~5 minutes
-4 patties	HIGH(100%)	4~6 minutes
<b>PORK</b>		
Loin, Leg	8	14~17 minutes
Bacon		
-4 slices	HIGH	3~4 minutes
-6 slices	HIGH	4~5 minutes

#### NOTE:

The above times should be regarded only as a guide. Allow for difference in individual tastes and preferences. The times may vary due to the shape, cut, and composition of the meat.

### POULTRY

1. No special techniques are required. The poultry should be prepared as for any other conventional method. Season if desired.
2. Poultry should be thoroughly defrosted, ensuring giblets and any metal clamps are removed.
3. Prick the skin and brush lightly with vegetable oil unless self-basting.
4. All poultry should be placed on a microwave roasting rack or a microwave-proof plate and placed on the turntable.
5. Cook according to the instructions in the cooking chart (below), turning the bird over halfway through the cooking time. Poultry, because of its shape, has a tendency to cook unevenly, especially in very bony parts. Turning the bird during roasting helps to cook these areas evenly.
6. STAND for 5-10 minutes wrapped in foil after cooking before carving. The standing time is very important, as it completes the cooking process.
7. Ensure poultry is thoroughly cooked before eating. Whole poultry is completely cooked when the juices run clear from the inside thigh when it is pierced with a sharp knife. poultry portions should be pierced with a sharp knife through the thickest part to ensure that the juices are clear and the flesh is firm.

#### POULTRY COOKING CHART

Poultry	Microwave power	Cooking time per pound
<b>CHICKEN</b>		
Whole	8	13~15 minutes
Breast(boned)	8	12~15 minutes
Portions	8	12~17 minutes
<b>TURKEY</b>		
Whole	8	13~15 minutes

#### NOTE:

\*The above times should be regarded only as a guide. Allow for difference in individual tastes and preferences. The times may vary due to the shape, cut, and composition of the food.

\*If whole birds are stuffed, the weight of the stuffed bird should be used when calculating the cooking time.

# Operating Instructions

## FISH

1. Arrange fish in a large shallow non-metallic dish or casserole.
2. Cover with pierced microwave plastic film or casserole lid.
3. Place the dish on the turntable.
4. Cook according to the instructions in the cooking chart (below). Butter can be added to the fish if desired.
5. Let STAND as directed in the cooking chart before serving.
6. After standing time, check to see that the fish is thoroughly cooked. The fish should be opaque and flake easily.

### FRESH FISH COOKING CHART

Fish	Microwave power	Cooking Time per pound	Butter	Standing Time
Fish Fillets	HIGH	6~8 minutes	Add 15~30 ml (1~2 tbsp.)	2~3 minutes
Whole Mackerel, Cleaned and Prepared	HIGH	6~8 minute	—	3~4 minutes
Whole Trout, Cleaned and Prepared	HIGH	8~10 minutes	—	3~4 minutes
Salmon Steaks	HIGH	8~10 minutes	Add 15~30 ml (1~2 tbsp.)	3~4 minutes

## Care and Cleaning

### CAUTION

To avoid risk of property damage, unplug the microwave oven or disconnect power at source by removing fuse or throwing circuit breaker.

Before cleaning the oven, unplug the power supply cord of the oven. If impossible, open the oven door to prevent an accidental oven start.

### INSIDE OF THE OVEN

Use a damp cloth to wipe out crumbs and spillovers. It is important to keep the area between door and cavity front clean to assure a tight seal. Remove greasy spatters with a sudsy cloth, then rinse and dry. Do not use harsh detergent or abrasive cleaners.

### GLASS TRAY

The glass tray can be washed by hand or in the dishwasher.

### CONTROL PANEL

Wipe with a damp cloth followed immediately by a dry cloth. The Child Lock feature is also useful when cleaning the control panel. Child Lock prevents accidental programming when wiping the control panel.

### DOOR

If steam accumulates inside or around the outside of the oven door, wipe the panel with a soft cloth. This may occur when the microwave oven is operated under high humidity conditions and in no way indicates a malfunction of the unit.

### OUTSIDE OVEN SURFACE

Clean with damp cloth. To prevent damage to the operating parts inside the oven, the water should not be allowed to seep into the ventilation openings.

After cleaning the oven, be sure that the rotating ring and the glass tray are in the right position. Press the STOP/ CLEAR pad twice to reset any accidental key setting.

# Heating or Reheating Guide

To heat or reheat successfully in the microwave, it is important to follow several guidelines. Measure the amount of food in order to determine the time needed to reheat. Arrange the food in a circular pattern for best results. Room temperature food will heat faster than refrigerated food. Canned foods should be taken out of the can and placed in a microwavable container. The food will be heated more evenly if covered with a microwavable lid or plastic wrap, vented. Remove cover carefully to prevent steam burns. Use the following chart as a guide for reheating cooked food.

Items	Cook time (at HIGH)	Special Instructions
Sliced meat 3 slices (1/4-inch thick)	2~3 minutes	Place sliced meat on microwavable plate. Cover with plastic wrap and vent. *Note: Gravy or sauce helps to keep meat juicy.
Chicken pies 1 breast 1 leg and thigh	3~4 minutes 3 1/2~5 minutes	Place chicken pieces on microwavable plate. Cover with plastic wrap and vent.
Fish fillet (6~8 oz.)	2 1/2~5 minutes	Place fish on microwavable plate. Cover with plastic wrap and vent.
Lasagna 1 serving (10 1/2 oz.)	5 1/2~6 1/2 minutes	Place lasagna on microwavable plate. Cover with plastic wrap and vent.
Casserole 1 cup 4 cups	2 1/2~3 1/2 minutes 12~14 minutes	COOK covered in microwavable casserole. Stir once halfway through cooking.
Casserole cream or cheese 1 cup 4 cups	2 1/2~4 minutes 10~12 minutes	COOK covered in microwavable casserole. Stir once halfway through cooking.
Sloppy Joe or Barbecued beef 1 sandwich (1/2 cup meat filling) without bun	2~3 minutes	Reheat filling and bun separately. Cook filling covered in microwavable casserole. Stir once. Heat bun as directed in chart below.
Mashed potatoes 1 cup 4 cups	2 1/2~4 minutes 6 1/2~9 minutes	COOK covered in microwavable casserole. Stir once halfway through cooking.
Baked beans 1 cup	2 1/2~3 1/2 minutes	COOK covered in microwavable casserole. Stir once halfway through cooking.
Ravioli or pasta in sauce 1 cup 4 cups	3 1/2~5 minutes 9~12 minutes	COOK covered in microwavable casserole. Stir once halfway through cooking.
Rice 1 cup 4 cups	3~4 minutes 4 1/2~8 minutes	COOK covered in microwavable casserole. Stir once halfway through cooking.
Sandwich roll or bun 1 roll	20~40 seconds	Wrap in paper towel and place on glass microwavable rack.
Vegetables 1 cup 4 cups	2~4 minutes 8~10 minutes	COOK covered in microwavable casserole. Stir once halfway through cooking.
Soup 1 serving(8 oz.)	2~3 1/2 minutes	COOK covered in microwavable casserole. Stir once halfway through cooking.



# Fresh Vegetable Chart

Vegetable	Amount	Cook time at HIGH	Instructions	Standing Time
Artichokes (8oz. each)	2 medium 4 medium	8~10 12~15	Trim. Add 2 tsp water and 2 tsp lemon juice. Cover.	2-3 minutes
Asparagus, Fresh, Spears	1lb.	5 <sup>1</sup> / <sub>2</sub> ~8 <sup>1</sup> / <sub>2</sub>	Add <sup>1</sup> / <sub>2</sub> cup water. Cover.	2-3 minutes
Beans, Green & Wax	1 lb.	10~13	Add <sup>1</sup> / <sub>2</sub> cup water in 1- <sup>1</sup> / <sub>2</sub> qt. covered casserole. Stir halfway through cooking.	2-3 minutes
Beets, Fresh	1 lb.	16 <sup>1</sup> / <sub>2</sub> ~19 <sup>1</sup> / <sub>2</sub>	Add <sup>1</sup> / <sub>2</sub> cup water in 1- <sup>1</sup> / <sub>2</sub> qt. covered casserole. Rearrange halfway through cooking.	2-3 minutes
Broccoli, Fresh, Spears	1lb.	8~10	Place broccoli in baking dish. Add <sup>1</sup> / <sub>2</sub> cup water.	2-3 minutes
Cabbage, Fresh, Chopped	1lb.	8~11	Add <sup>1</sup> / <sub>2</sub> cup water in 1- <sup>1</sup> / <sub>2</sub> qt. covered casserole. Stir halfway through cooking.	2-3 minutes
Carrots, Fresh, Sliced	2 cups	4 <sup>1</sup> / <sub>2</sub> ~6 <sup>1</sup> / <sub>2</sub>	Add <sup>1</sup> / <sub>4</sub> cup water in 1 qt. covered casserole. Stir halfway through cooking.	2-3 minutes
Cauliflower, Fresh, Whole	1 lb.	9~11	Trim. Add <sup>1</sup> / <sub>4</sub> cup water in 1 qt. covered casserole. Stir halfway through cooking.	2-3 minutes
Fresh, Flowerettes Celery, Fresh, Sliced	2 cups 4 cups	4 <sup>1</sup> / <sub>2</sub> ~6 8~10 <sup>1</sup> / <sub>2</sub>	Slice. Add <sup>1</sup> / <sub>2</sub> cup water in 1- <sup>1</sup> / <sub>2</sub> qt. covered casserole. Stir halfway through cooking	2-3 minutes
Corn, Fresh	2 ears	7~10	Husk. Add 2 tbsps water in 1- <sup>1</sup> / <sub>2</sub> qt. baking dish. Cover.	2-3 minutes
Mushrooms, Fresh, Sliced	1/2 lb.	2 <sup>1</sup> / <sub>2</sub> ~4	Place mushrooms in 1- <sup>1</sup> / <sub>2</sub> qt. covered casserole. Stir halfway through cooking.	2-3 minutes
Parsnips, Fresh, Sliced	1lb.	6~9	Add <sup>1</sup> / <sub>2</sub> cup water in 1- <sup>1</sup> / <sub>2</sub> qt. covered casserole. Stir halfway through cooking.	2-3 minutes
Peas, Green, Fresh	4 cups	9~11	Add <sup>1</sup> / <sub>2</sub> cup water in 1- <sup>1</sup> / <sub>2</sub> qt. covered casserole. Stir halfway through cooking.	2-3minutes
Sweet Potatoes Whole Baking (6-8 oz. each)	2 medium 4 medium	7~11 9~14	Pierce potatoes several times with fork. Place on 2 paper towels. Turn over halfway through cooking.	2-3 minutes 2-3 minutes
White potatoes, Whole Baking (6-8 oz. each)	2 potatoes 4 potatoes	8~10 <sup>1</sup> / <sub>2</sub> 13 <sup>1</sup> / <sub>2</sub> ~16	Pierce potatoes several times with fork. Place on 2 paper towels. Turn over halfway through cooking	2-3 minutes 2-3 minutes
Spinach, Fresh, Leaf	1lb.	7~9	Add <sup>1</sup> / <sub>2</sub> cup water in 2 qt. covered casserole.	2-3 minutes
Squash, Acorn or Butternut, Fresh	1 medium	9~11	Cut squash in half. Remove seeds. Place in 8x8-inch baking dish. Cover.	2-3 minutes
Zucchini, Fresh, Sliced	1lb.	8~10	Add <sup>1</sup> / <sub>2</sub> cup water in 1- <sup>1</sup> / <sub>2</sub> qt. covered casserole. Stir halfway through cooking.	2-3 minutes
Zucchini, Fresh, Whole	1lb.	9~12	Pierce. Place on 2 paper towels. Turn zucchini over and rearrange halfway through cooking.	2-3 minutes

# Troubleshooting

## **WARNING**

To avoid risk of severe personal injury, electrical shock or death, do not remove outer case of at any time. Only an authorized servicer should remove outer case.

## BEFORE CALLING FOR SERVICE

Check the following list to be sure a service call is really necessary. A quick reference of this manual as well as reviewing additional information on items to check may prevent an unneeded service call.

Problem	Possible Causes
Oven will not start at all	<ul style="list-style-type: none"> <li>• Electrical cord for oven is not plugged in.                             <ul style="list-style-type: none"> <li>-Plug into the outlet.</li> </ul> </li> <li>• Door is open.                             <ul style="list-style-type: none"> <li>-Close the door, open, and try again.</li> </ul> </li> <li>• Wrong operation is set.                             <ul style="list-style-type: none"> <li>-Check operation instructions.</li> </ul> </li> </ul>
Arcing or sparking	<ul style="list-style-type: none"> <li>• Materials to be avoided in microwave oven are used.                             <ul style="list-style-type: none"> <li>-Use microwave-safe cookware only.</li> </ul> </li> <li>• The oven is operated when empty.                             <ul style="list-style-type: none"> <li>-Do not operate with oven empty.</li> </ul> </li> <li>• Food refuse remains in the cavity or inside the cavity is uncleaned.                             <ul style="list-style-type: none"> <li>-Clean cavity with wet towel.</li> </ul> </li> </ul>
Uneven cooking or poor defrosting	<ul style="list-style-type: none"> <li>• Materials to be avoided in microwave oven are used.                             <ul style="list-style-type: none"> <li>-Use microwave-safe cookware only.</li> </ul> </li> <li>• Cooking time/Cooking power level is not suitable.                             <ul style="list-style-type: none"> <li>-Use correct time/Cooking power level.</li> </ul> </li> <li>• Food is not turned or stirred.                             <ul style="list-style-type: none"> <li>-Turn or stir food.</li> </ul> </li> </ul>
Overcooked foods	<ul style="list-style-type: none"> <li>• Cooking time/Cooking power level is not suitable.                             <ul style="list-style-type: none"> <li>-Use correct time/cooking power level when you cook the same food.</li> </ul> </li> </ul>
Undercooked foods	<ul style="list-style-type: none"> <li>• Materials to be avoided in microwave oven are used.                             <ul style="list-style-type: none"> <li>-Use microwave-safe cookware only.</li> </ul> </li> <li>• Food is not defrosted completely.                             <ul style="list-style-type: none"> <li>-Completely defrost food.</li> </ul> </li> <li>• Oven ventilation ports are restricted.                             <ul style="list-style-type: none"> <li>-Check to see that oven ventilation ports are not restricted.</li> </ul> </li> <li>• Cooking time/Cooking power level is not suitable.                             <ul style="list-style-type: none"> <li>-Use correct time/Cooking power level when you cook the same food.</li> </ul> </li> </ul>

## ALL THESE THINGS ARE NORMAL

- Dull thumping sound during oven operation.
- Steam or vapor escaping from around the door.
- Light reflection around door or outer wrapper.
- Dimming oven light and change in blower sound during oven operation at power levels other than high.
- Some radio and TV interference might occur during operations. It is similar to the interference caused by other small appliances such as mixers, blow dryer, etc.

# Amana Warranty

## Full ONE Year Warranty

Amana Appliances will repair or replace, including related labor and travel, any part (f.o.b. Amana Iowa) which proves defective as to workmanship or materials.

## Limited Warranty

After one year from the date of original retail purchase, Amana will provide a free part, as listed below, to replace any part that fails due to a defect in materials or workmanship. The owner will be responsible for paying all other costs including labor, mileage, and transportation.

## Second through Fifth Year

Amana will repair or replace, including related labor, a magnetron tube (f.o.b. Amana Iowa) which proves defective as to workmanship or materials when carried into an authorized Amana servicer.

## What is not covered by these warranties

- Replacement of household fuses, resetting of circuit breakers, or correction to household wiring or plumbing.
- Normal product maintenance and cleaning, including light bulbs.
- Products with original serial numbers removed, altered, or not readily determined.
- Products purchased for commercial, industrial, rental, or leased use.
- Products located outside of the United States or Canada.
- Premium service charges, if the servicer is requested to perform service in addition to normal service or outside normal service hours or area.
- Adjustments after the first year.
- Repairs resulting from the following:
  - Improper installation, exhaust system, or maintenance.
  - Any modification, alteration, or adjustment not authorized by Amana.
  - Accident, misuse, abuse, fire, flood, or acts of nature.
  - Connections to improper electrical current, voltage supply, or gas supply.
  - Use of improper pans, containers, or accessories that cause damage to the product.

## To Receive Warranty Service

Service must be performed by an authorized Amana service representative. To schedule service, contact the Amana dealer where you purchased your appliance or contact Amana Appliances Factory Service.

### Amana Appliances Factory Service

1-800-628-5782 inside USA

### For more information, Amana Appliances Consumer Services

Amana Appliances  
2800 220th Trail  
Amana, Iowa 52204  
1-800-843-0304 inside USA  
(319) 622-5511 worldwide

When contacting Amana Appliances please include the following information:

- Your name, address, and telephone number.
- Model number and serial number of your appliance.
- The name and address of your dealer and the date of purchase.
- A clear description of the problem.
- Proof of purchase (sales receipt).

## IN NO EVENT SHALL AMANA BE LIABLE FOR INCIDENTAL OR CONSEQUENTIAL DAMAGES.

This warranty gives you specific legal rights, and you may have others which vary from state to state. For example, some states do not allow the exclusion or limitation of incidental or consequential damages, so this exclusion may not apply to you.

**Amana Appliances Online • <http://www.amana.com>**

Part No. 12401528  
Printed in China 03/01

2001 Amana Appliances  
Amana, Iowa 52204