



Use And Care

G U I D E



Table of Contents (complete).....	2
A Note to You	3
Microwave Oven Safety	4-6
Getting to Know Your Microwave Oven	7
Using Your Microwave Oven	24
Caring for Your Microwave Oven	43
Cooking Guide	48
Questions and Answers	52
Troubleshooting	53
Requesting Assistance or Service	55
Warranty	60

In the U.S.A. for assistance or service,
call the Consumer Assistance Center.

1-800-253-1301

In Canada for assistance
or service, see page 56.

MICROWAVE HOOD COMBINATION

MODELS MH6130XE YMH6130XE

Table of Contents

A Note to You	3	Using “QUICK TOUCH” COOK	28
Microwave Oven Safety	4-6	Using “QUICK TOUCH” DEFROST	29
Important safety instructions	4	Defrost chart	31
Precautions to avoid possible exposure to excessive microwave energy	5	Defrosting tips	34
Electrical requirements	6	Using WARM HOLD	35
Grounding instructions	6	Using “QUICK TOUCH” REHEAT	36
Getting to Know your Microwave Oven	7	Using VEGETABLE	37
How your microwave oven works	7	Using FROZEN ENTREE	38
For the best cooking results	9	Using BEVERAGE	39
Radio interference	9	Using BAKED POTATO	40
Testing your microwave oven	9	Using POPCORN	40
Testing your dinnerware or cookware	10	Using ADD MINUTE	42
Operating safety precautions	10	Adding or subtracting cook time	42
Electrical connection	12	Caring for Your Microwave Oven	43
Microwave oven features	13	Caring for the filters	44
Control panel features	14	Replacing the cooktop and oven lights	46
Using the fan	17	Cooking Guide	48
Using the cooktop/countertop light	18	Reheating chart	48
Setting the clock	20	Microwave cooking chart	49
Using the Minute Timer	22	Microwave cooking tips	50
Using Your Microwave Oven	24	Questions and Answers	52
Cooking at high cook power	24	Troubleshooting	53
Cooking at different cook powers	25	Requesting Assistance or Service	55
Cooking with more than one cook cycle	27	Warranty	60

A Note to You

Thank you for buying a WHIRLPOOL* appliance.

Because your life is getting busier and more complicated, WHIRLPOOL appliances are easy to use, save time, and help you manage your home better. To ensure that you enjoy years of trouble-free operation, we developed this Use and Care Guide. It is full of valuable information about how to operate and maintain your appliance properly and safely. Please read it carefully.

Also, please complete and mail in the **Product Registration Card** provided with your appliance. The card helps us notify you about any new information on your appliance.

Please record your model's information.

Whenever you call to request service for your appliance, you need to know your complete model number and serial number. You can find this information on the model and serial number label/plate (see diagram in the "Microwave oven features" section).

Please also record the purchase date of your appliance and your dealer's name, address, and telephone number.

Model Number _____

Serial Number _____

Purchase Date _____

Dealer Name _____

Dealer Address _____

Dealer Phone _____

Keep this book and the sales slip together in a safe place for future reference. It is important for you to save your sales receipt showing the date of purchase. Proof of purchase will assure you of in-warranty service.

In the U.S.A., call our Consumer Assistance Center toll free.

1-800-253-1301

To find detailed product information, the location of the nearest Whirlpool dealer or authorized servicer, to purchase an accessory item, or register your appliance on-line, please visit our Web site at www.whirlpool.com

In Canada, for assistance or service, see the "Requesting Assistance or Service" section.

In Canada visit our Web site at www.whirlpool.com

Microwave Oven Safety

Your safety and the safety of others is very important.

We have provided many important safety messages in this manual and on your appliance. Always read and obey all safety messages.



This is the safety alert symbol.

This symbol alerts you to hazards that can kill or hurt you and others.

All safety messages will be preceded by the safety alert symbol and the word "DANGER" or "WARNING." These words mean:

⚠ DANGER

You **will** be killed or seriously injured if you don't follow instructions.

⚠ WARNING

You **can** be killed or seriously injured if you don't follow instructions.

All safety messages will identify the hazard, tell you how to reduce the chance of injury, and tell you what can happen if the instructions are not followed.

IMPORTANT SAFETY INSTRUCTIONS

When using electrical appliances basic safety precautions should be followed, including the following:

WARNING: To reduce the risk of burns, electric shock, fire, injury to persons or exposure to excessive microwave energy:

- Read all instructions before using the microwave oven.
- Read and follow the specific "PRECAUTIONS TO AVOID POSSIBLE EXPOSURE TO EXCESSIVE MICROWAVE ENERGY" found in this section.
- The microwave oven must be grounded. Connect only to properly grounded outlet. See "GROUNDING INSTRUCTIONS" found at the end of this section.
- Install or locate the microwave oven only in accordance with the provided installation instructions.
- Some products such as whole eggs and sealed containers – for example, closed glass jars – may explode and should not be heated in the microwave oven.
- Use the microwave oven only for its intended use as described in this manual. Do not use corrosive chemicals or vapors in the microwave oven. This type of oven is specifically designed to heat, cook, or dry food. It is not designed for industrial or laboratory use.
- As with any appliance, close supervision is necessary when used by children.
- Do not operate the microwave oven if it has a damaged cord or plug, if it is not working properly, or if it has been damaged or dropped.
- The microwave oven should be serviced only by qualified service personnel. Call an authorized service company for examination, repair or adjustment.
- Do not cover or block any openings on the microwave oven.

– SAVE THESE INSTRUCTIONS –

IMPORTANT SAFETY INSTRUCTIONS

- Do not store the microwave oven out-doors. Do not use the microwave oven near water – for example, near a kitchen sink, in a wet basement, or near a swimming pool, and the like.
- Do not immerse cord or plug in water.
- Keep cord away from heated surfaces.
- Do not let cord hang over edge of table or counter.
- See door surface cleaning instructions in the “Caring for Your Microwave Oven” section.
- Do not mount over a sink.
- Do not store anything directly on top of the microwave oven when the microwave oven is in operation.
- To reduce the risk of fire in the oven cavity:
 - Do not overcook food. Carefully attend the microwave oven if paper, plastic, or other combustible materials are placed inside the oven to facilitate cooking.
 - Remove wire twist-ties from paper or plastic bags before placing bag in oven.
- If materials inside the oven should ignite, keep oven door closed, turn oven off, and disconnect the power cord, or shut off power at the fuse or circuit breaker panel.
- Do not use the cavity for storage purposes. Do not leave paper products, cooking utensils, or food in the cavity when not in use.
- Suitable for use above both gas and electric cooking equipment.
- Intended to be used above ranges with maximum width of 36 inches (91 cm).
- Clean Ventilating Hoods Frequently – Grease should not be allowed to accumulate on hood or filter.
- When flaming foods under the hood, turn the fan off. The fan, if operating, may spread the flame.
- Use care when cleaning the vent-hood filter. Corrosive cleaning agents, such as lye-based oven cleaners, may damage the filter.

– SAVE THESE INSTRUCTIONS –

PRECAUTIONS TO AVOID POSSIBLE EXPOSURE TO EXCESSIVE MICROWAVE ENERGY

- (a) Do not attempt to operate this oven with the door open since open-door operation can result in harmful exposure to microwave energy. It is important not to defeat or tamper with the safety interlocks.
- (b) Do not place any object between the oven front face and the door or allow soil or cleaner residue to accumulate on sealing surfaces.
- (c) Do not operate the oven if it is damaged. It is particularly important that the oven door close properly and that there is no damage to the:
 - (1) door (bent),
 - (2) hinges and latches (broken or loosened),
 - (3) door seals and sealing surfaces.
- (d) The oven should not be adjusted or repaired by anyone except properly qualified service personnel.

Electrical requirements

Observe all governing codes and ordinances. A 120 Volt, 60 Hz, AC only, 20 amp fused electrical supply is required. (A time-delay fuse is recommended.) It is recommended that a separate circuit serving only this appliance be provided.

⚠ WARNING



Electrical Shock Hazard

**Plug into a grounded 3 prong outlet.
Do not remove ground prong.
Do not use an adapter.
Do not use an extension cord.
Failure to follow these instructions
can result in death, fire,
or electrical shock.**

GROUNDING INSTRUCTIONS

For all cord connected appliances:
The microwave oven must be grounded. In the event of an electrical short circuit, grounding reduces the risk of electric shock by providing an escape wire for the electric current. The microwave oven is equipped with a cord having a grounding wire with a grounding plug. The plug must be plugged into an outlet that is properly installed and grounded.

WARNING – Improper use of the grounding can result in a risk of electric shock.

Consult a qualified electrician or serviceman if the grounding instructions are not

completely understood, or if doubt exists as to whether the microwave oven is properly grounded.

Do not use an extension cord. If the power supply cord is too short, have a qualified electrician or serviceman install an outlet near the microwave oven.

For a permanently connected appliance: The microwave oven must be connected to a grounded, metallic, permanent wiring system, or an equipment grounding conductor should be run with the circuit conductors and connected to the equipment grounding terminal or lead on the appliance.

Getting to Know Your Microwave Oven

This section discusses the concepts behind microwave cooking. It also shows you the basics you need to know to operate your microwave oven. Please read this information before you use your oven.



⚠️ WARNING

Explosion Hazard

Do not store flammable materials such as gasoline near the microwave oven.

Doing so can result in death, explosion, or fire.

How your microwave oven works

Microwave ovens are safe. Microwave energy is not hot. It causes food to make its own heat, and it's this heat that cooks the food.

Microwaves are like TV waves or light waves. You cannot see them, but you can see what they do.

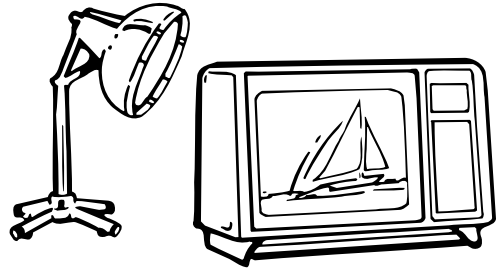

A magnetron in the microwave oven produces microwaves. The microwaves move into the oven where they contact food as it turns on the turntable.

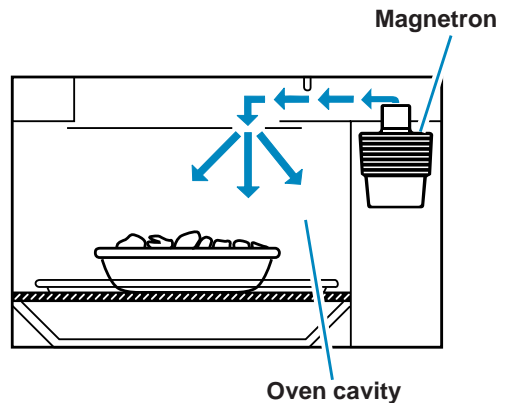

continued on next page

GETTING TO KNOW YOUR MICROWAVE OVEN

The **glass turntable** of your microwave oven lets microwaves pass through. Then they bounce off a metal floor, back through the glass turntable, and are absorbed by the food.

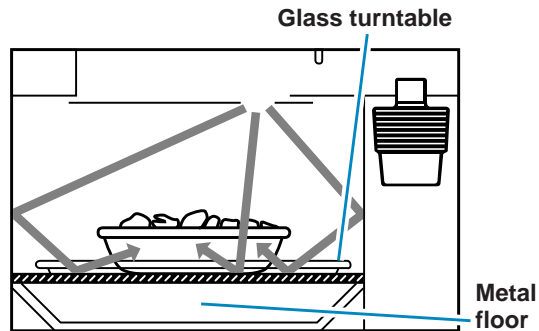

Microwaves pass through most glass, paper, and plastics without heating them so food absorbs the energy. Microwaves bounce off metal containers so food does not absorb the energy.

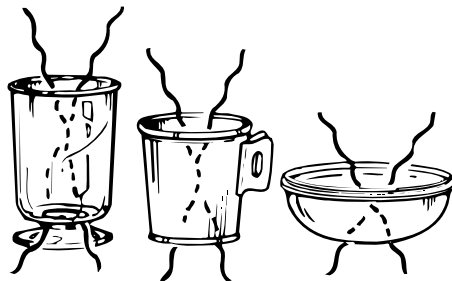

Microwaves may not reach the center of a roast. The heat spreads to the center from the outer, cooked areas just as in regular oven cooking. This is one of the reasons for letting some foods (for example, roasts or baked potatoes) stand for a while after cooking, or for stirring some foods during the cooking time.

The microwaves disturb water molecules in the food. As the molecules bounce around bumping into each other, heat is made, like rubbing your hands together. This is the heat that does the cooking.

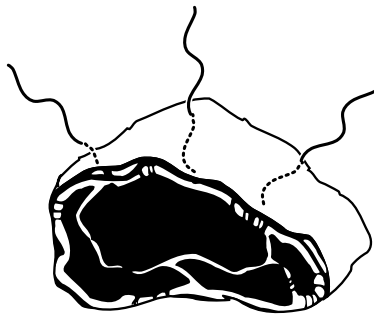

NOTE: Do not deep fry in the oven. Microwavable cookware is not suitable and it is difficult to maintain appropriate deep-frying temperatures.

For the best cooking results

- **Always cook food** for the shortest cooking time recommended. Check to see how the food is cooking. If needed, touch ADD MINUTE while the oven is operating or after the cooking cycle is over (see the “Using ADD MINUTE” section).
- **Stir, turn over, or rearrange** the food being cooked about halfway through the cooking time for all recipes. This will help make sure the food is evenly cooked.
- **If you do not have a cover** for a dish, use wax paper, or microwave-approved paper towels or plastic wrap. Remember to turn back a corner of the plastic wrap to vent steam during cooking.

Radio interference

Using your microwave oven may cause interference to your radio, TV, or similar equipment. When there is interference, you can reduce it or remove it by:

- **Cleaning** the door and sealing surfaces of the oven.
- **Adjusting** the receiving antenna of the radio or television.
- **Moving** the radio/TV away from the microwave oven.
- **Plugging** the microwave oven into a different outlet so that the microwave oven and radio/TV are on different branch circuits.

Testing your microwave oven

To test the oven put about 1 cup (250mL) of cold water in a glass container in the oven. Close the door. Make sure it latches. Follow the directions in the “Cooking at high cook power” section to set the oven to cook for 2 minutes. When the time is up, the water should be heated.



Testing your dinnerware or cookware

Test dinnerware or cookware before using.

To test a dish for safe use, put it into the oven with a cup of water beside it. Cook at 100% cook power for one minute. **If the dish gets hot and water stays cool, do not use it.**

Some dishes (melamine, some ceramic dinnerware, etc.) absorb microwave energy, becoming too hot to handle and slowing cooking times. Cooking in metal containers not designed for microwave use could damage the oven, as could containers with hidden metal (twist-ties, foil lining, staples, metallic glaze or trim).

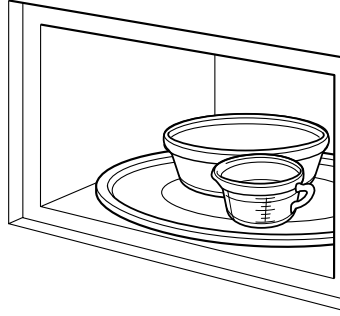

Operating safety precautions

Never cook or reheat a whole egg inside the shell. Steam buildup in whole eggs may cause them to burst and burn you, and possibly damage the oven. **Slice** hard-boiled eggs before heating. In rare cases, poached eggs have been known to explode. **Cover** poached eggs and **allow** a standing time of one minute before cutting into them.

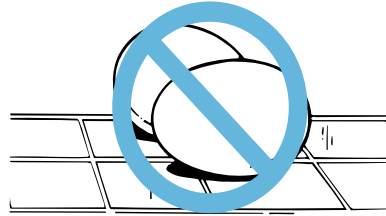

For best results, stir any liquid several times during heating or reheating. Liquids heated in certain containers (especially containers shaped like cylinders) may become overheated. The liquid may splash out with a loud noise during or after heating or when adding ingredients (coffee granules, tea bags, etc.). This can harm the oven and possibly injure someone.

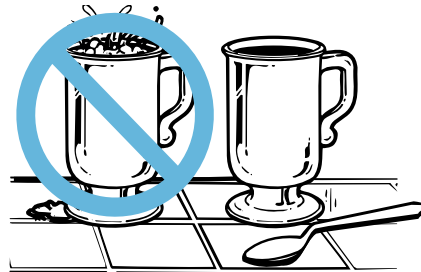

Stir during heating

Never lean on the door or allow a child to swing on it when the door is open. Injury could result.

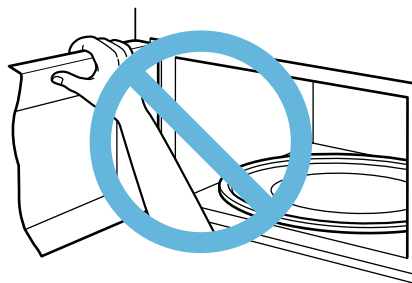

Use hot pads. Microwave energy does not heat containers, but heat from the food can make the container hot.

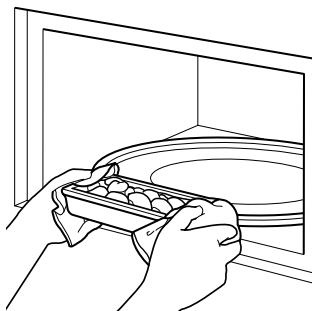

Do not overcook potatoes. Fire could result. At the end of the recommended cooking time, potatoes should be slightly firm because they will continue cooking during standing time.

After microwaving, wrap potatoes in foil and **set aside** for 5 minutes. They will finish cooking while standing.

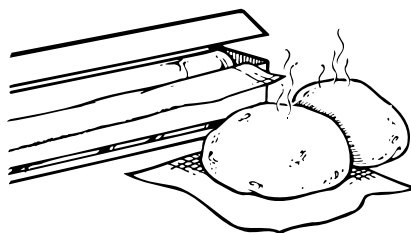

Do not start a microwave oven when it is empty. Product life may be shortened.

If you practice programming the oven, **put** a container of water in the oven.

It is normal for the oven door to look wavy after the oven has been running for a while.

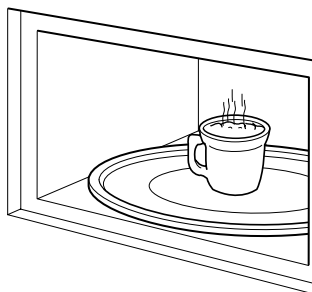

Do not use newspaper or other printed paper in the oven. Fire could result.

Do not dry flowers, fruit, herbs, wood, paper, gourds, or clothes in the oven. Fire could result.

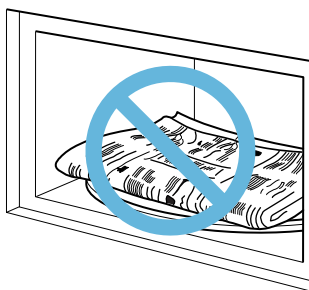

continued on next page

Do not try to melt paraffin wax in the oven. Paraffin wax will not melt in a microwave oven because it allows microwaves to pass through it.



Do not operate the microwave oven unless the glass turntable is securely in place and can rotate freely. The turntable can rotate in either direction.

Make sure the turntable is correct-side up in the oven. **Carefully place** the cookware on your turntable to avoid possibly breaking it.

Handle your turntable with care when removing it from the oven to avoid possibly breaking it. If your turntable cracks or breaks, contact your dealer for a replacement.

When you use a browning dish, the browning dish bottom must be at least $\frac{3}{16}$ inch (5 mm) above the turntable. Follow the directions supplied with the browning dish.

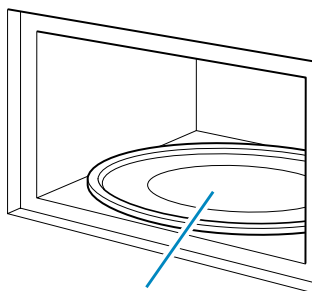

Glass turntable

Electrical connection

If your electric power line or outlet voltage is less than 110 volts, cooking times may be longer. Have a qualified electrician check your electrical system.

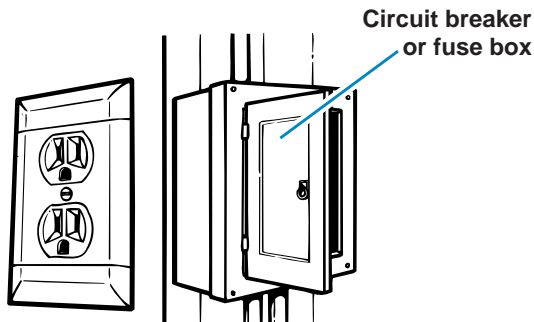

Microwave oven features

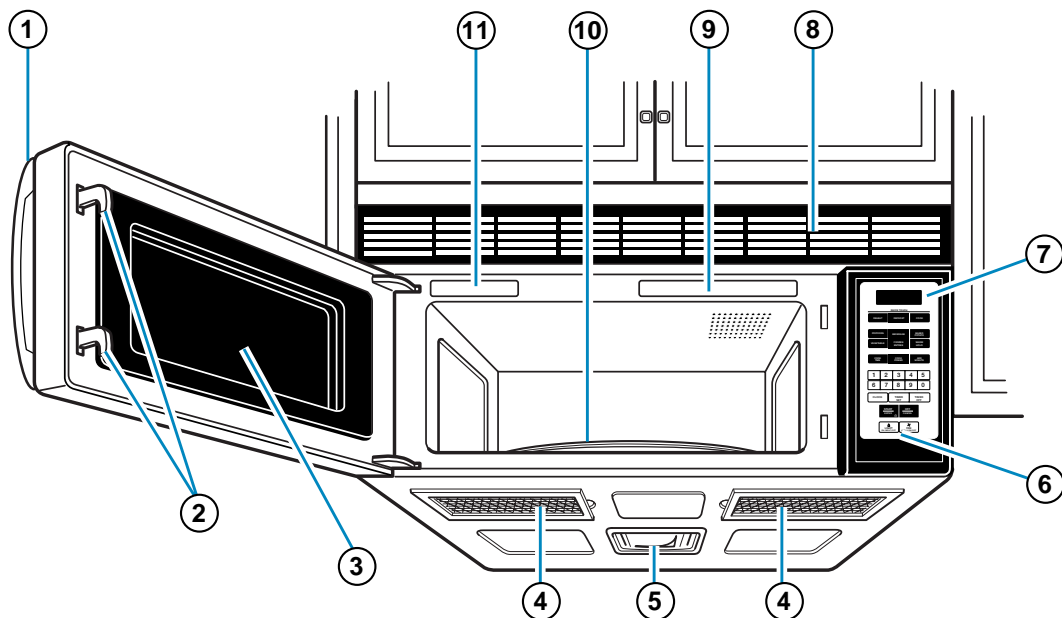

Your microwave oven is designed to make your cooking experience as enjoyable and productive as possible. To get you up and running quickly, the following is a list of the oven's basic features:

- 1. Door Handle.** Pull to open door.
- 2. Door Safety Lock System.** The oven will not operate unless the door is securely closed.
- 3. Window with Metal Shield.** Shield prevents microwaves from escaping. It is designed as a screen to allow you to view food as it cooks.
- 4. Filter.** See page 44 for cleaning information.
- 5. Cooktop/Countertop Light.** Turn on to light your cooktop or countertop or turn on as a night light. See page 18 for more information.
- 6. Fan and Cooktop Light Switches.** See pages 17 to 20 for more information.
- 7. Control Panel.** Touch the pads on this panel to perform all functions. See pages 14 to 16 for more information.
- 8. Vent Grille.**
- 9. Cooking Guide.** Use as a quick reference for Cook and Defrost settings.
- 10. Glass Turntable.** The turntable turns food as it cooks for more even cooking. It must be in the oven during operation for best cooking results. See pages 12, 43, 52, and 54 for more information.
- 11. Model and Serial Number Plate.**

Control panel features

Your microwave oven control panel lets you select the desired cooking function quickly and easily. All you have to do is touch the necessary Command pad. The following is a list of all the Command and Number pads located on the control panel. For more information, see pages 17 to 42.

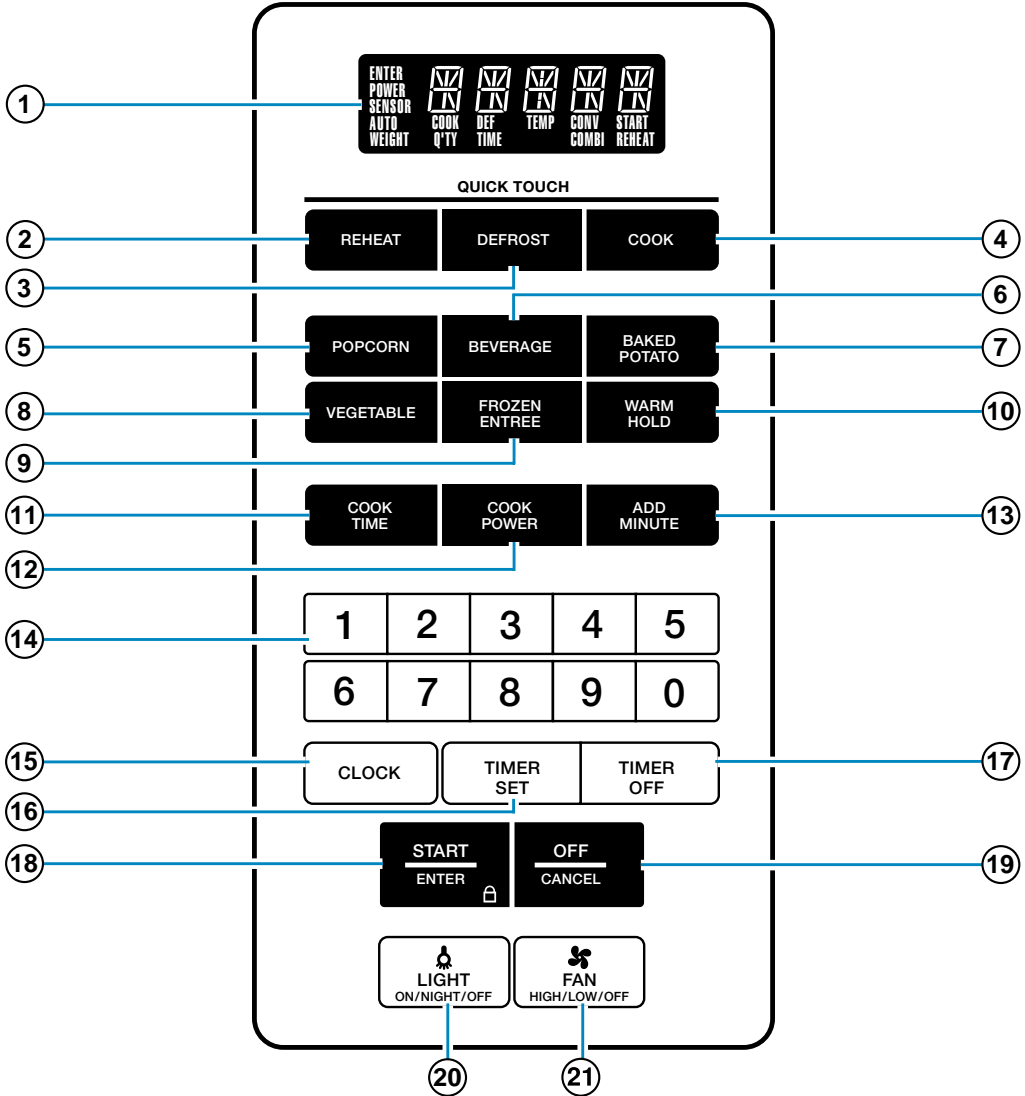

- 1. Display.** The display includes a clock and indicators to tell you time of day, cooking time settings, and cooking functions selected.
- 2. REHEAT.** Touch this pad to reheat food from 5 preset categories. See page 36 for more information.

- 3. DEFROST.** Touch this pad followed by Number pads to thaw frozen food by weight. See page 29 for more information.
- 4. COOK.** Touch this pad to cook common microwave-prepared foods without needing to program times and cook powers. See page 28 for more information.

5. **POPCORN.** Touch this pad when popping popcorn in your microwave oven. The oven will automatically heat for a preset time at a preset cook power, based on bag size. See page 40 for more information.
6. **BEVERAGE.** Touch this pad to reheat 8 or 16 oz of a beverage. The oven will automatically heat for a preset time at a preset cook power. See page 39 for more information.
7. **BAKED POTATO.** Touch this pad to cook 1 to 4 potatoes without needing to program times and cook powers. See page 40 for more information.
8. **VEGETABLE.** Touch this pad to cook vegetables by choosing a preset category and quantity. See page 37 for more information.
9. **FROZEN ENTREE.** Touch this pad to cook frozen entrees by choosing a preset weight. See page 38 for more information.
10. **WARM HOLD.** Touch this pad to keep hot, cooked foods safely warm in your oven for up to 99 minutes, 99 seconds. Use WARM HOLD by itself, or set it to automatically follow a cooking cycle. See page 35 for more information.
11. **COOK TIME.** Touch this pad followed by Number pads to set a cooking time. See pages 24, 26, and 27 for more information.
12. **COOK POWER.** Touch this pad after the cook time has been set, followed by a Number pad to set the amount of microwave energy released to cook the food. The higher the number, the higher the microwave power or “cooking speed.” See page 25 for more information. See the “Microwave cooking chart” on page 49 for specific cook powers to use for the foods you are cooking.
13. **ADD MINUTE.** Touch this pad to cook for 1 minute, at 100% cook power, or to add an extra minute, at the set cook power to your cooking cycle. See page 42 for more information.
14. **Number Pads.** Touch Number pads to enter cooking times, cook powers, temperatures, quantities, weights, or food categories.
15. **CLOCK.** Touch this pad to enter the correct time of day. See page 20 for more information.
16. **TIMER SET.** Touch this pad to set the Minute Timer. See page 22 for more information.
17. **TIMER OFF.** Touch this pad to cancel the Minute Timer. See page 23 for more information.
18. **START/ENTER.** Touch this pad to start a function. If you open the door after the oven begins to cook, touch START/ENTER again to restart oven. See page 16 for more information.
19. **OFF/CANCEL.** Touch this pad to erase an incorrect command, cancel a program during cooking, or to clear the display. See page 16 for more information.
20. **LIGHT.** Touch this pad to turn on the cooktop/countertop light. See page 18 for more information.
21. **FAN.** Touch this pad to turn the fan on or off. See page 17 for more information.

NOTES:

- **If you have entered** all settings for a function but do not touch START/ENTER within 5 seconds, the START indicator light will flash.
- **If you open** the door while the oven is on and then shut the door, the START indicator light will flash. Touch START/ENTER to restart the oven.
- **If you choose** a function but do not press another Command pad within 1 minute, the display returns to the time of day and you have to start over.

Audible signals

Audible signals are available to guide you when setting and using your oven:

- **A programming tone will sound** each time you touch a pad.
- **One long tone** signals the end of a Minute Timer countdown.
- **Four tones** signal the end of a cooking cycle.
- **Two tones** sound once every minute after an End-of-Cooking signal as a reminder if food has not been removed from oven.
- **Three tones** sound if you have made an incorrect entry.

To disable all audible signals:

- **Touch and hold** Number pad 1 for 4 seconds to disable all programming tones.

To turn all signals back on:

Repeat step under “To disable all audible signals” above.

NOTE: Three tones, followed by two tones, will sound when audible signals are turned on or off. The three tones will be omitted if all tones are disabled.

Interrupting cooking

You can stop the oven during a cycle by opening the door. The oven stops heating and the fan stops, but the light stays on.

To restart cooking, close the door and

TOUCH



If you do not want to continue cooking:

- **Close** the door and the light goes off.

OR

- **TOUCH**



Using the child lock

The Child Lock locks the control panel so children cannot use the microwave oven when you do not want them to.

To lock the control panel:

Touch and hold START/ENTER for 4 seconds. Three tones, followed by 2 tones, will sound and “LOC” will appear on the display.

To unlock the control panel:

Touch and hold START/ENTER for 4 seconds. Two tones will sound and “LOC” will be cleared from the display.

Using the demo/learning feature

You can see your microwave oven’s functions without turning the oven on.

NOTE: This feature can only be used when the microwave oven is first connected to power. You cannot use the demo/learning feature after a Command pad has been touched.

To set the demo/learning feature:

1. **Open** the door and **keep** it open.
2. **Touch and hold** Number pad 0 for 4 seconds. Three tones, followed by two tones, will sound.
3. **Release** Number pad 0.
4. **Shut** the door to start the demo/learning feature.

To cancel the demo/learning feature:

Touch OFF/CANCEL.

Using the fan

The pad on the bottom right of the control panel controls the 2-speed Fan.

1. Choose fan speed.

Press FAN once for HIGH, twice for LOW.

NOTE: If the temperature gets too hot around the microwave oven, the exhaust fan in the vent hood will automatically turn on at the LOW setting to protect the oven. It may stay on up to an hour to cool the oven. When this occurs, you can not turn the fan off manually.

TOUCH



(once for HIGH)

OR



(twice for LOW)

2. Turn fan off when desired.

TOUCH



(until off)

To set fan to run for a specific time:

1. Start fan.

TOUCH



(once or twice)

2. Touch TIMER SET.

NOTES:

- **Be sure** you have set a time of day with the CLOCK function before setting any Timer function.
- **If both** the fan and light are operating and TIMER is touched twice, both the fan and light will be controlled by the timer. The display will alternate between "FAN" and "LIGHT" one time before "HR:MN" is displayed.

TOUCH



(twice within 3 seconds)

YOU SEE



Then:



continued on next page

3. Set fan run time.

Example to run the fan for 1 hour and 30 minutes:

TOUCH



YOU SEE



4. Start timed fan function.

NOTE: The letter “F” indicates the timed fan feature has been selected. If both the timed fan and light feature have been selected, an “H” (Hood) will be displayed.

At end of time, the current time of day will show and no tones will sound.

TOUCH



OR



YOU SEE



To cancel the timed fan function:

NOTE: Touching TIMER OFF shuts off both the fan and timed function. Touching FAN shuts off just the fan.

TOUCH



Using the cooktop/countertop light

The pad on the bottom left of the control panel controls the cooktop/countertop light.

1. Turn on light.

Press LIGHT once for HIGH, twice for LOW (night).

TOUCH



(once for HIGH)

OR



(twice for LOW)

2. Turn light off when desired.

TOUCH



(until off)

To set light to be on for a specific time:

1. Turn on light.

TOUCH



(once or twice)

2. Touch TIMER SET.

NOTES:

- **Be sure** you have set a time of day with the Clock function before setting any Timer function.
- **If both** the fan and light are operating and TIMER is touched twice, both the fan and light will be controlled by the timer. The display will alternate between "FAN" and "LIGHT" one time before "HR:MN" is displayed.

TOUCH



(twice within 3 seconds)

YOU SEE



Then:



3. Set light on time.

Example to turn light on for 1 hour and 30 minutes:

TOUCH



YOU SEE



continued on next page

4. Start timed light function.

NOTE: The letter “L” indicates the timed light feature has been selected. If both the timed light and fan feature have been selected, an “H” (Hood) will be displayed.

At end of time, the current time of day will show and no tones will sound.

TOUCH



YOU SEE



OR



To cancel the timed light function:

NOTE: Touching TIMER OFF shuts off both the light and timed function. Touching LIGHT shuts off just the light.

TOUCH



Setting the clock

When your microwave oven is first plugged in or after a power failure, the display will show “88:88.” For the first 30 seconds after the power is on, you can set the clock time without touching CLOCK. After 30 seconds has gone by, you must follow the directions below to set the time. If a time of day is not set, “88:88” will show on the display until you touch CLOCK.

NOTES:

- **You can** only set the clock if the oven is not cooking food.
- **If you enter** an incorrect time and touch CLOCK, three tones will sound. Enter the correct time.
- **If you touch** OFF/CANCEL while setting the clock, the display will show the last time of day set or “:.” if no time of day has been set.

To set time:

1. Touch CLOCK.

TOUCH

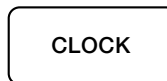

YOU SEE



(for 3 seconds)

2. Enter time of day.

Example for 12:00:

TOUCH

1

2

0

0

YOU SEE



Then:



3. Complete entry.

TOUCH



OR



YOU SEE



Using the Minute Timer

You can use your microwave oven as a minute timer. Use the Minute Timer for timing up to 99 minutes, 99 seconds.

NOTE: The oven can operate while the Minute Timer is in use. To see the Minute Timer while the oven is cooking, touch **TIMER SET**. To return the display to the cooking time countdown, touch **TIMER SET** again.

1. Touch **TIMER SET**.

TOUCH



YOU SEE



After 1 second:

Then:



2. Enter time to be counted down.

Example for 1 minute, 30 seconds:

NOTE: If you enter more than 4 digits, 3 tones will sound. Touch **START/ENTER** to count down the 3-digit time you have entered or touch **TIMER OFF** to clear the display. To start over, touch **TIMER SET** and re-enter desired time.

TOUCH



YOU SEE



3. Start countdown.

NOTE: If you do not do this step within 3 seconds of doing Step 2, "START" will flash. You then have 1 minute to touch START/ENTER or TIMER SET before the display returns to time of day.

TOUCH



OR



YOU SEE



At end of countdown:

YOU SEE



(one tone will sound)

To cancel Minute Timer:

During countdown:

TOUCH



YOU SEE



(time of day)

After countdown:



Using Your Microwave Oven

This section gives you instructions for operating each function. Please read these instructions carefully.

Cooking at high cook power

1. Put food in oven and close the door.

2. Set cooking time.

TOUCH



YOU SEE



Example for 1 minute, 30 seconds:

TOUCH



YOU SEE



3. Start oven.

TOUCH



YOU SEE



At end of cooking time:

YOU SEE



Changing instructions

You can change the cooking time after cooking starts by repeating Steps 2 and 3.

Cooking at different cook powers

For best results, some recipes call for different cook powers. The lower the cook power, the slower the cooking. Each Number pad also stands for a different percentage of cook power. Many microwave cookbook recipes tell you by number, percent, or name which cook power to use.

The following chart gives the percentage of cook power each Number pad stands for, and the cook power name usually used. It also tells you when to use each cook power. Follow recipe or food package instructions if available.

COOK POWER	NAME	WHEN TO USE IT
10=100% of full power	High	<ul style="list-style-type: none"> • Quick heating many convenience foods and foods with high water content, such as soups and beverages • Cooking small tender pieces of meat, ground meat, poultry pieces, fish fillets, and vegetables
9=90% of full power		<ul style="list-style-type: none"> • Heating cream soups
8=80% of full power		<ul style="list-style-type: none"> • Heating rice, pasta, or casseroles
7=70% of full power	Medium-High	<ul style="list-style-type: none"> • Cooking and heating foods that need a Cook Power lower than high (for example, whole fish and meat loaf) or when food is cooking too fast • Reheating a single serving of food
6=60% of full power		<ul style="list-style-type: none"> • Cooking requiring special care, such as cheese and egg dishes, pudding, and custards • Finishing cooking casseroles
5=50% of full power	Medium	<ul style="list-style-type: none"> • Cooking ham, whole poultry, and pot roasts • Melting chocolate
4=40% of full power		<ul style="list-style-type: none"> • Simmering stews • Heating pastries
3=30% of full power	Medium-Low, Defrost	<ul style="list-style-type: none"> • Defrosting foods, such as bread, fish, meats, poultry, and precooked foods
2=20% of full power		<ul style="list-style-type: none"> • Softening butter, cheese, and ice cream
1=10% of full power	Low	<ul style="list-style-type: none"> • Keeping food warm • Taking chill out of fruit

NOTE: Once cook time has been entered you can also use the COOK POWER pad as a second Minute Timer by entering “0” for the cook power. The oven will count down the cooking time you set without cooking.

1. Put food in oven and close the door.

2. Set cooking time.

TOUCH



YOU SEE



Example for 7 minutes, 30 seconds:

TOUCH



YOU SEE



3. Set cook power.

TOUCH



YOU SEE



Example for 50% cook power:

TOUCH



YOU SEE



4. Start oven.

TOUCH



YOU SEE



At end of cooking time:

YOU SEE



Changing instructions

You can change the cooking time or cook power after cooking starts by repeating Steps 2 and/or 3 and 4.

Cooking with more than one cook cycle

For best results, some recipes call for one cook power for a certain length of time, and another cook power for another length of time. Your oven can be set to change from one to another automatically, for up to two cycles.

1. Put food in oven and close the door.

2. Set cooking time for first cycle.

TOUCH



YOU SEE



Example for 7 minutes, 30 seconds:

TOUCH



YOU SEE

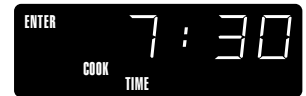

3. Set cook power for first cycle.

TOUCH



YOU SEE



Example for 50% cook power:

TOUCH



YOU SEE



4. Repeat Steps 2 and 3 to set cooking time and cook power for the second cycle.

continued on next page

5. Start oven.

After the first cycle is over, the next cycle will count down.

At end of cooking time:

TOUCH



YOU SEE



(first cycle)

YOU SEE



Changing instructions

You can change times or cook powers for a cycle any time after that cycle starts by repeating Steps 2 and/or 3 and 4.

Using "QUICK TOUCH" COOK

Cooking with "QUICK TOUCH" COOK lets you heat common microwave-prepared foods without needing to program times and cook powers. COOK has preset times and cook powers for 3 food categories: Casserole, Bacon, and Rice.

To use COOK:

1. **Touch** COOK once for Casserole, twice for Bacon, or three times for Rice.
2. **Wait** 4 seconds.
3. **Touch** COOK again to increase the number of cups/items.

1. Put food in oven and close the door.

Refer to the following chart for quantities:

CATEGORY	NUMBER OF CUPS/ITEMS
Casserole	1, 2, 3, 4 cups
Bacon	2, 4, 6, 8 slices
Rice	0.5, 1, 1.5, 2 cups

NOTE: See "Microwave cooking chart" in the "Cooking Guide" section for cooking with cook power and cooking time.

2. Choose COOK.

Example for Casserole:

After 4 seconds:

TOUCH



(once)

YOU SEE



YOU SEE



(for 3 seconds)

3. Increase quantity to 2 cups (within 3 seconds).

TOUCH



(once)

YOU SEE



Then:



(time may vary)

YOU SEE



At end of cooking time:

Using "QUICK TOUCH" DEFROST

Your microwave oven automatically defrosts a variety of common meats at preset cook powers for preset times. The 3-stage defrost cycle is programmed for meat, poultry, and fish.

To use DEFROST:

1. **Touch** DEFROST once for meat, twice for poultry, or three times for fish.
2. **Wait** 4 seconds.
3. **Enter** the weight using the Number pads.
4. **Touch** START/ENTER.

After approximately one-third and two-thirds of the defrost cycle, the oven will stop and prompt you to turn the food over.

1. **Put frozen food in oven and close the door.**

NOTES:

- **See** the "Defrost chart" later in the "Using Your Microwave Oven" section for defrosting directions for each food.
- **To defrost items not listed** in "Defrost chart" use 30% cook power. Refer to a reliable cookbook for defrosting information.

Refer to the following chart to choose a category:

CATEGORY	TOUCH DEFROST
Meat	once
Poultry	twice
Fish	three times

continued on next page

2. Choose DEFROST.

Example for meat:

TOUCH

DEFROST

(once)

YOU SEE



After 4 seconds:

YOU SEE



3. Enter food's weight (in pounds and tenths of a pound).

Example for 1.2 lbs (544 g):

NOTES:

- **For converting fractions** of a pound to decimals, see "Weight conversion chart" later in this section.
- **If you enter** an incorrect weight, touch DEFROST again and enter the correct weight.

TOUCH

1

2

YOU SEE

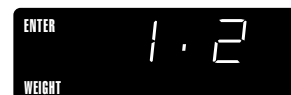

4. Start oven.

TOUCH

START
ENTER



YOU SEE



(time may vary)

5. After a third of the cook time is over, display will prompt you to turn over food.

Open door, turn over food, and shield any warm portions.

NOTE: If you do not open the door within 2 minutes, the display will resume the countdown.

YOU SEE



6. Close the door.

YOU SEE



(approximate time remaining)

7. Restart oven.

TOUCH



YOU SEE



(approximate time remaining)

8. After two-thirds of the cook time is over, display will prompt you to turn food over. Repeat steps 5, 6, and 7.

YOU SEE



(approximate time remaining)

At end of defrosting time:

YOU SEE



Defrost chart

Meat setting

FOOD	AT PAUSE	SPECIAL INSTRUCTIONS
Beef		Meat of irregular shape and large, fatty cuts of meat should have the narrow or fatty areas shielded with foil at the beginning of a defrost cycle.
Ground Beef, Bulk	Remove thawed portions with fork. Turn over. Return remainder to oven.	Do not defrost less than ¼ lb (113 g).
Ground Beef, Patties	Separate and rearrange.	Do not defrost less than two 4 oz (113 g) patties.

continued on next page

USING YOUR MICROWAVE OVEN

FOOD	AT PAUSE	SPECIAL INSTRUCTIONS
Beef (cont.)		
Round Steak	Turn over. Cover warm areas with aluminum foil.	Place on a microwavable roasting rack.
Tenderloin Steak	Turn over. Cover warm areas with aluminum foil.	Place on a microwavable roasting rack.
Stew Beef	Remove thawed portions with fork. Separate remainder. Return remainder to oven.	Place in a microwavable baking dish.
Pot Roast, Chuck Roast	Turn over. Cover warm areas with aluminum foil.	Place on a microwavable roasting rack.
Rib Roast	Turn over. Cover warm areas with aluminum foil.	Place on a microwavable roasting rack.
Rolled Rump Roast	Turn over. Cover warm areas with aluminum foil.	Place on a microwavable roasting rack.
Lamb		
Cubes for Stew	Remove thawed portions with fork. Return remainder to oven.	Place in a microwavable baking dish.
Chops (1 inch [2.54 cm] thick)	Separate and rearrange.	Place on a microwavable roasting rack.
Pork		
Chops (½ inch [1.27 cm] thick)	Separate and rearrange.	Place on a microwavable roasting rack.
Hot Dogs	Separate and rearrange.	Place on a microwavable roasting rack.
Spareribs, Country-Style Ribs	Turn over. Cover warm areas with aluminum foil.	Place on a microwavable roasting rack.
Sausage, Links	Separate and rearrange.	Place on a microwavable roasting rack.
Sausage, Bulk	Remove thawed portions with fork. Turn over. Return remainder to oven.	Place in a microwavable baking dish.
Loin Roast, Boneless	Turn over. Cover warm areas with aluminum foil.	Place on a microwavable roasting rack.

Fish setting

FOOD	AT PAUSE	SPECIAL INSTRUCTIONS
Fish		
Filletts	Turn over. Separate filletts when partially thawed.	Place in a microwavable baking dish. Carefully separate filletts under cold water.
Steaks	Separate and rearrange.	Place in a microwavable baking dish. Run cold water over to finish defrosting.
Whole	Turn over.	Place in a microwavable baking dish. Cover head and tail with foil; do not let foil touch sides of microwave oven. Finish defrosting by immersing in cold water.
Shellfish		
Crabmeat	Break apart. Turn over.	Place in a microwavable baking dish.
Lobster Tails	Turn over and rearrange.	Place in a microwavable baking dish.
Shrimp	Separate and rearrange.	Place in a microwavable baking dish.
Scallops	Separate and rearrange.	Place in a microwavable baking dish.

Poultry setting

FOOD	AT PAUSE	SPECIAL INSTRUCTIONS
Chicken		
Whole (up to 9½ lbs [4.3 kg])	Turn over (finish defrosting breast-side down). Cover warm areas with aluminum foil.	Place chicken breast-side up on a microwavable roasting rack. Finish defrosting by immersing in cold water. Remove giblets when chicken is partially defrosted.
Cut Up	Separate pieces and rearrange. Turn over. Cover warm areas with aluminum foil.	Place on a microwavable roasting rack. Finish defrosting by immersing in cold water.
Cornish Hens		
Whole	Turn over. Cover warm areas with aluminum foil.	Place on a microwavable roasting rack. Finish defrosting by immersing in cold water.
Turkey		
Breast (under 6 lbs [2.7 kg])	Turn over. Cover warm areas with aluminum foil.	Place on a microwavable roasting rack. Finish defrosting by immersing in cold water.

Weight conversion chart

You are probably used to food weights as being in pounds and ounces that are fractions of a pound (for example $\frac{1}{4}$ pound equals 4 ounces). However, in order to enter food weight in DEFROST, you must specify pounds and tenths of a pound.

If the weight on the food package is in fractions of a pound, you can use the following chart to convert the weight to decimals.

DECIMAL WEIGHT	EQUIVALENT OUNCE WEIGHT	EQUIVALENT GRAM WEIGHT
.10	1.6	45
.20	3.2	91
.25 One-Quarter Pound	4.0	113
.30	4.8	136
.40	6.4	181
.50 One-Half Pound	8.0	227
.60	9.6	272
.70	11.2	318
.75 Three-Quarters Pound	12.0	340
.80	12.8	363
.90	14.4	408
1.00 One Pound	16.0	454

Defrosting tips

- **When using DEFROST**, the weight to be entered is the net weight in pounds and tenths of pounds (the weight of the food minus the container).
- **Only use DEFROST** for raw food. DEFROST gives best results when food to be thawed is a minimum of 0°F (-18°C). If food has been stored in a refrigerator-freezer that does not maintain a temperature of 0°F (-18°C) or below, always program a lower food weight (for a shorter defrosting time) to prevent cooking the food.
- **If the food is kept outside** the freezer for up to 20 minutes, enter a lower food weight.
- **If the food is kept outside** the freezer for more than 20 minutes, and for defrosting ready-made food, defrost by time and power and let stand after defrosting.
- **The shape of the package** alters the defrosting time. Shallow rectangular packets defrost more quickly than a deep block.
- **Separate pieces** as they begin to defrost. Separated pieces defrost more evenly.
- **You can use small pieces** of aluminum foil to shield foods like chicken wings, leg tips, and fish tails, but the foil must not touch the side of the oven. Foil can damage the oven lining.
- **Shield areas of food** with small pieces of foil if they start to become warm. Make sure the foil does not touch the sides, top, or bottom of the oven.
- **For better results, a preset standing time** is included in the defrosting time. This may make the defrosting time seem longer than expected. (For more information on standing time, see “Microwave cooking tips” in the “Cooking Guide” section.)

Using WARM HOLD

You can safely keep hot, cooked food warm in your microwave oven for up to 99 minutes, 99 seconds (about 1 hour, 40 minutes). You can use WARM HOLD by itself, or to automatically follow a cooking cycle.

NOTES:

- **WARM HOLD** operates for up to 99 minutes, 99 seconds.
- **Opening** the oven door cancels WARM HOLD. Close the door and touch WARM HOLD, then touch START/ENTER if additional WARM HOLD time is desired.

- **Food cooked covered** should be covered during WARM HOLD.
- **Pastry items** (pies, turnovers, etc.) should be uncovered during WARM HOLD.
- **Complete meals** kept warm on a dinner plate should be covered during WARM HOLD.
- **Do not use** more than one complete WARM HOLD cycle (about 1 hour, 40 minutes). The quality of some foods will suffer with extended time.

1. Put hot, cooked food in oven and close the door.

2. Touch setting.

TOUCH



YOU SEE



3. Start oven (optional).

TOUCH



YOU SEE



To make WARM HOLD automatically follow another cycle:

- **While you are entering cooking instructions**, touch WARM HOLD before touching START/ENTER.
- **When the last cooking cycle is over**, you will hear two tones. "WARM" will come on while the oven continues to run.
- **You can set WARM HOLD to follow** DEFROST, COOK, or multi-cycle cooking.

Using "QUICK TOUCH" REHEAT

You can reheat food by choosing a category and quantity. REHEAT has preset times and cook powers for five categories: Pizza, Plate, Soup/Sauce, Casserole, and Baked Goods.

To use REHEAT:

1. **Touch** REHEAT once for Pizza, twice for Plate, three times for Soup/Sauce, four times for Casserole, and five times for Baked Goods.
2. **Wait** 4 seconds.
3. **Touch** REHEAT again to increase the number of servings or items.

1. **Put food in oven and close the door.**

Refer to the following chart for quantities:

CATEGORY	NUMBER OF CUPS/ITEMS
Pizza	1 to 3 slices, 5 oz each
Plate	1 to 2 servings
Soup/Sauce	1 to 4 cups
Casserole	1 to 4 cups
Baked Goods	1 to 4 items, 2 oz each (56 g)

NOTE: See the "Reheating chart" in the "Cooking Guide" section for reheating with cook power and cooking time.

2. Touch REHEAT.

Example for Plate:

TOUCH



(twice)

YOU SEE



After 4 seconds:

YOU SEE



(for 3 seconds)

3. Increase to 2 servings (within 3 seconds of step 2).

TOUCH



YOU SEE



Then:



(time may vary)

At end of heating time:

YOU SEE



Using VEGETABLE

You can cook vegetables by choosing a preset category and quantity. VEGETABLE has preset times and cook powers for 3 categories: Fresh, Frozen, and Canned.

To use VEGETABLE:

1. **Touch** VEGETABLE once for Fresh, twice for Frozen, or three times for Canned.
2. **Wait** 4 seconds.
3. **Touch** VEGETABLE again to increase the quantity. Each time you touch VEGETABLE, the quantity increases by 1 cup, up to a maximum of 4 cups.

1. Put vegetables in oven and close the door.

2. Touch VEGETABLE.

Example for Fresh:

TOUCH



(once)

YOU SEE



After 4 seconds:

YOU SEE



(for 3 seconds)

3. Increase quantity.

Example for 2 cups:

TOUCH



(twice)

YOU SEE



Then



(time may vary)

At end of cooking time:

YOU SEE



Using FROZEN ENTREE

You can cook frozen entrees by choosing a preset weight. FROZEN ENTREE has preset times and cook powers for two weights. To select weight, touch FROZEN ENTREE once for 10 oz (284 g) or twice for 20 oz (568 g). Your microwave oven does the rest.

1. Put frozen entree in oven and close the door.

2. Touch FROZEN ENTREE.

Example for 10 oz (284 g):

TOUCH

FROZEN
ENTREE

(once)

YOU SEE



After 3 seconds:

YOU SEE



(time remaining)
(time may vary)

After cooking time is finished:

YOU SEE



After 1 minute:

YOU SEE



Using BEVERAGE

BEVERAGE lets you heat a beverage by touching just one pad.

NOTE: If you want to change the heating time after choosing BEVERAGE, see the “Adding or subtracting cook time” section.

1. Place cup of beverage in oven and close the door.

2. Touch BEVERAGE.

To heat an 8 oz (227 mL) cup of a beverage:

TOUCH

BEVERAGE

(once)

YOU SEE



To heat a 16 oz (455 mL) cup of a beverage:

TOUCH

BEVERAGE

(twice)

YOU SEE

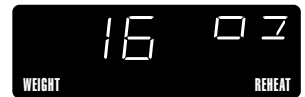

In 3 seconds, the display will start counting down.

Example for 8 oz (227 mL):

YOU SEE



(time may vary)

At end of heating time:

YOU SEE



Using BAKED POTATO

BAKED POTATO lets you cook potatoes (8 to 10 oz each [227 to 284 g]) by touching just one pad. With the preset times and cook powers, all you do is touch BAKED POTATO (1 to 4 times) to select the desired number of potatoes (1 to 4). Your microwave oven does the rest.

1. Place potatoes in oven and close the door.

2. Touch BAKED POTATO.

Example for 2 potatoes:

After 3 seconds:

At end of cooking time:

NOTES:

- **Before baking**, pierce potato with fork several times.
- **After baking**, wrap potato in foil and let stand for 5 minutes.

TOUCH



(twice)

YOU SEE



YOU SEE



(time may vary)

YOU SEE



Using POPCORN

You can pop commercially packaged microwave popcorn by touching just one pad. The number of times you touch this pad determines which size of popcorn your oven will pop.

For best results:

- **Pop** only one package at a time.
- **If you are using** a microwave popcorn popper, follow the manufacturer's instructions.
- **Cooking performance** may vary with brand and fat content. Try several brands to decide which gives best popping results.
- **Use** fresh bags of popcorn.

1. Place the bag in the center of the turntable and close the door.

To correctly set your microwave oven, follow this chart:

Bag Size – ounces	3.50 oz (100 g)	3.00 oz (85 g)	1.75 oz (50 g)
Touch POPCORN	once	twice	three times

NOTE: If you want to shorten or lengthen the cooking time after choosing POPCORN, see “Adding or subtracting cook time” at the end of the “Using Your Microwave Oven” section.

2. Touch POPCORN.

Example for 3.5 oz (100 g) regular bags:

After 3 seconds, oven starts popping popcorn:

Every 10 seconds the display will alternate between "POP-" and "CORN" and then show the time remaining.

At end of popping time:

TOUCH



(once)

YOU SEE



YOU SEE



(time counts down)
(time may vary)

YOU SEE



(time counts down)
(time may vary)

YOU SEE



Using ADD MINUTE

ADD MINUTE lets you cook food for 1 minute at 100% cook power or add an extra minute to your cook time cycle. You can also use it to extend cook time cycles in multiples of 1 minute, up to 99 minutes.

NOTES:

- **To extend** cook time cycles in multiples of 1 minute, touch ADD MINUTE repeatedly during cooking.

- **After closing the door**, you can enter ADD MINUTE after touching START/ENTER.
- **If you touch** ADD MINUTE during cooking, the oven will cook at the currently selected cook power. If you touch ADD MINUTE after cooking is over, the oven will cook at 100% cook power.
- **You can use** ADD MINUTE only for the cook time function.

1. Make sure food is in oven.

2. Touch ADD MINUTE.

Example for cooking for 1 minute:

TOUCH



YOU SEE



Adding or subtracting cook time

If a preset cook time is too long or too short, you can increase or decrease the cook time by 10% after choosing the function. You can only increase or decrease cook time before cooking starts.

To increase cook time by 10%:

TOUCH



YOU SEE



To decrease cook time by 10%:

TOUCH



YOU SEE



To reset to the original cook time:

TOUCH



YOU SEE



Caring for Your Microwave Oven

To make sure your microwave oven looks good and works well for a long time, you should maintain it properly. For proper care, please follow these instructions carefully.

For interior surfaces: Wash often with warm, sudsy water and a sponge or soft cloth. Use only mild, nonabrasive soaps or a mild detergent. **Be sure to keep the areas clean where the door and oven frame touch when closed.** Wipe well with clean water. Over time, stains can occur on the surfaces as the result of food particles spattering during cooking. This is normal.

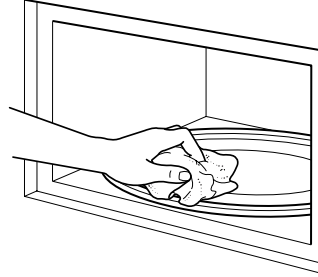

For stubborn soil, **boil** a cup of water in the oven for 2 or 3 minutes. Steam will soften the soil. To get rid of odors inside the oven, **boil** a cup of water with lemon juice or vinegar.

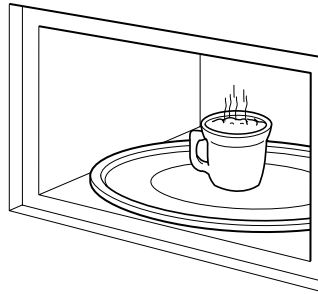

For exterior surfaces and control panel: Use a soft cloth with spray glass cleaner. Apply the spray glass cleaner to the soft cloth; do not spray directly on the oven.

NOTE: Abrasive cleansers, steel-wool pads, gritty wash cloths, some paper towels, etc., can damage the control panel and the interior and exterior oven surfaces.

To clean turntable and turntable support, wash in mild, sudsy water; for heavily soiled areas use a mild cleanser and scouring sponge. The turntable and turntable support are dishwasher safe.

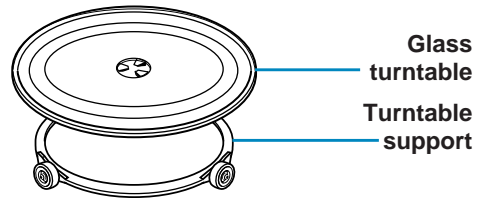

Caring for the filters

Do not allow grease and soil to build up in the grease filters. It will decrease the exhaust fan efficiency. Remove and clean grease filters at least once a month. When you have removed a grease filter or a charcoal filter remember to replace the filter before you operate the hood.

NOTE: If your microwave hood combination is installed to recirculate air, the charcoal filter (available from your authorized service company, Part No. 4359416) should be installed. The charcoal filter cannot be cleaned and should be replaced every 6 to 12 months.

⚠ WARNING



Electrical Shock Hazard

Disconnect power before removing vent cover.

Replace all panels before operating.

Failure to do so can result in death or electrical shock.

Before removing filters:

- **Unplug** microwave oven or disconnect power.

Grease filters:

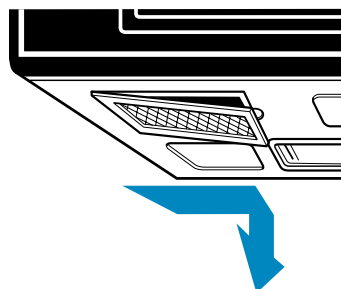

1. To remove grease filters, slide each filter to the side. Pull filters downward and push to the other side. The filter will drop out.

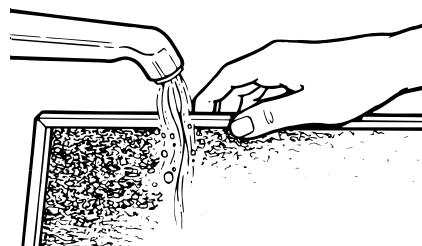

2. Soak grease filters in hot water and a mild detergent. Scrub and swish to remove embedded dirt and grease. Rinse well and shake to dry. Do not clean filters with ammonia, corrosive cleaning agents such as lye-based oven cleaners, or place them in a dishwasher. The filters will turn black or could be damaged.



3. To replace grease filters, slide filter in the frame slot on one side of the opening. Push filter upward and push to the other side to lock into place.

Charcoal filter:

To remove:

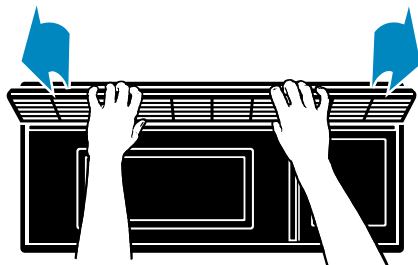

1. Remove the vent cover mounting screws.
2. Tip the cover forward, then lift out to remove.

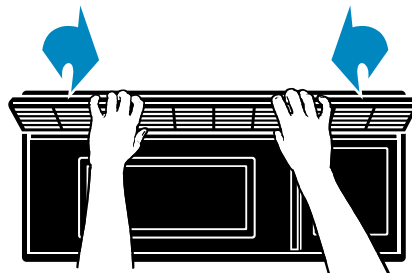

2. Slide the bottom of the vent cover into place. Push the top until it snaps into place. Replace the mounting screws.

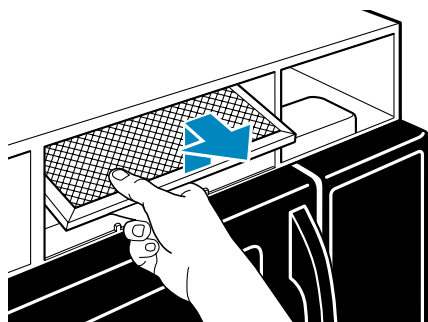

3. Lift the back of the charcoal filter. Slide the filter straight out.

To replace:

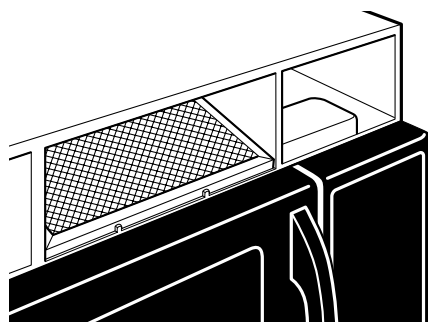

1. Slide a new charcoal filter into place. The filter should rest at the angle shown.

After replacing filters:

- Plug in microwave oven or reconnect power.

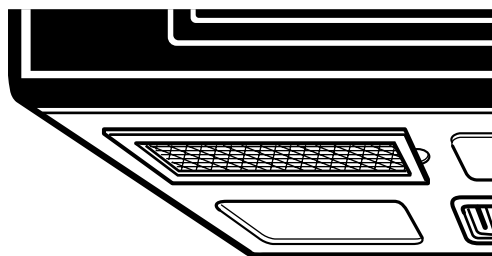

NOTE: Do not operate the hood without the filters in place.

Replacing the cooktop and oven lights

⚠ WARNING



Fire Hazard

Use only candelabra-base bulbs, 40-watt maximum.

Disconnect power before replacing light bulb.

Failure to do so can result in fire or electrical shock.

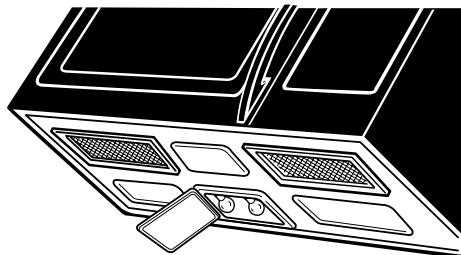

The cooktop light

1. Unplug microwave oven or disconnect power.

- 2. Remove** the bulb cover mounting screws.
- 3.** We recommend replacing bulb(s) with candelabra-base 40-watt bulb(s) available from your authorized service company, or by calling the Consumer Assistance Center at **1-800-253-1301** (U.S.A.) or **1-800-461-5681** (Canada). Make sure to have your model number when ordering.
- 4. Plug in** microwave oven or reconnect power.

The oven light

⚠️ WARNING



Electrical Shock Hazard

Disconnect power before removing vent cover.
 Replace all panels before operating.
 Failure to do so can result in death or electrical shock.

1. **Unplug** microwave oven or disconnect power.

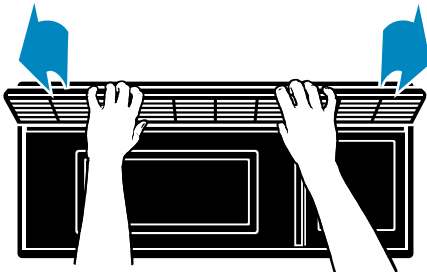

2. **Remove** the vent cover mounting screws.
3. **Tip** the cover forward, then **lift out** to remove.

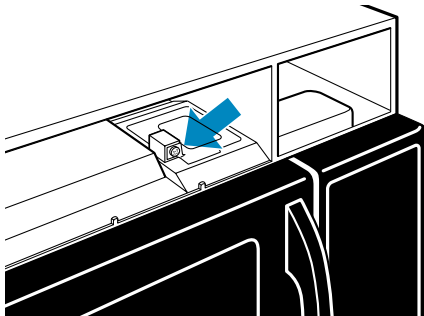

4. **Remove** bulb holder mounting screw.

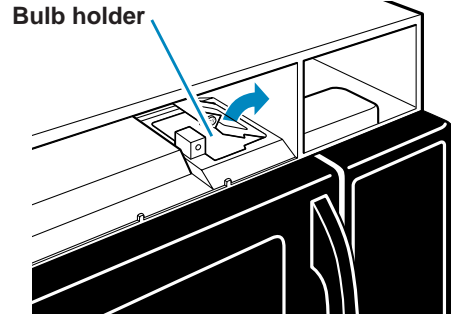

5. **Lift up** the bulb holder.
6. We recommend replacing the bulb with a candelabra-base 40-watt bulb available from your authorized service company, or by calling the Consumer Assistance Center at **1-800-253-1301** (U.S.A.) or **1-800-461-5681** (Canada). Make sure to have your model number when ordering.
7. **Replace** the bulb holder and mounting screw.

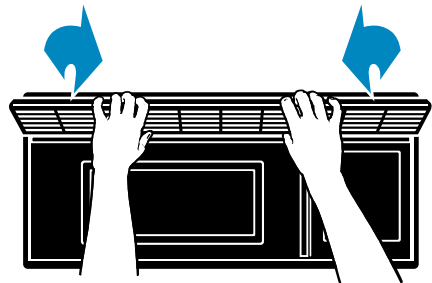

8. **Slide** the top of the vent cover into place. **Push** the bottom until it snaps into place. **Replace** the mounting screws.
9. **Plug in** microwave oven or reconnect power.

Cooking Guide

Reheating chart

Times are approximate and may need to be adjusted to individual taste.

NOTE: See the “Using ‘QUICK TOUCH’ REHEAT” in the “Using Your Microwave Oven” section for instructions on how to reheat by touching just one Command pad.

ITEM	STARTING TEMP	TIME/POWER	PROCEDURE
Meat (Chicken pieces, chops, hamburgers, meat loaf slices) 1 serving 2 servings	Refrigerated Refrigerated	1 to 2 min at 70% 2½ to 4½ min at 70%	Cover loosely.
Meat Slices (Beef, ham, pork, turkey) 1 or more servings	Room temp Refrigerated	45 sec to 1 min per serving at 50% 1 to 3 min per serving at 50%	Cover with gravy or wax paper. Check after 30 seconds per serving.
Stirrable Casseroles and Main Dishes 1 serving 2 servings 4 to 6 servings	Refrigerated Refrigerated Refrigerated	2 to 4 min at 100% 4 to 6 min at 100% 6 to 8 min at 100%	Cover. Stir after half the time.
Nonstirrable Casseroles and Main Dishes 1 serving 2 servings 4 to 6 servings	Refrigerated Refrigerated Refrigerated	5 to 8 min at 50% 9 to 12 min at 50% 13 to 16 min at 50%	Cover with wax paper.
Soup, Cream 1 cup 1 can (10¾ oz [305 g])	Refrigerated Room temp	3 to 4½ min at 50% 5 to 7 min at 50%	Cover. Stir after half the time.
Soup, Clear 1 cup 1 can (10¾ oz [305 g])	Refrigerated Room temp	2½ to 3½ min at 100% 4 to 5½ min at 100%	Cover. Stir after half the time.
Pizza 1 slice 1 slice 2 slices 2 slices	Room temp Refrigerated Room temp Refrigerated	15 to 25 sec at 100% 30 to 40 sec at 100% 30 to 40 sec at 100% 45 to 55 sec at 100%	Place on paper towel.
Vegetables 1 serving 2 servings	Refrigerated Refrigerated	¾ to 1½ min at 100% 1½ to 2½ min at 100%	Cover. Stir after half the time.
Baked Potato 1 2	Refrigerated Refrigerated	1 to 2 min at 50% 2 to 3 min at 50%	Cut potato lengthwise and then several times cross-wise. Cover with wax paper.
Breads (Dinner or breakfast roll) 1 roll 2 rolls 4 rolls	Room temp Room temp Room temp	8 to 12 sec at 50% 11 to 15 sec at 100% 18 to 22 sec at 100%	Wrap single roll, bagel, or muffin in paper towel. To reheat several, line plate with paper towel. Cover with another paper towel.
Pie Whole 1 slice	Refrigerated Refrigerated	5 to 7 min at 70% 30 sec at 100%	Cover with paper towel.

Microwave cooking chart

Times are approximate and may need to be adjusted to individual taste.

NOTE: See “Using ‘QUICK TOUCH’ COOK” in the “Using Your Microwave Oven” section for cooking without cook powers or cooking times.

MEATS, POULTRY, FISH, SEAFOOD Allow standing time after cooking.			VEGETABLES (continued) Cook at 100% cook power.		
FOOD	COOK POWER	TIME	FOOD	TIME	
Bacon (per slice)	100%	45 sec to 1 min 15 sec per slice	Cauliflower (medium head)	6 to 9 min	
Ground Beef for Casse-roles (1 lb)	100%	4 to 6 min	Corn on the Cob (2) (4)	4 to 9 min 6 to 16 min	
Hamburger Patties (2)	100%	1st side 2 min 2nd side 1½ to 2½ min	Potatoes, Baked (4 medium)	13 to 19 min	
Hamburger Patties (4)	100%	1st side 2½ min 2nd side 2 to 3 min	Squash, Summer (1 lb/454 g)	3 to 8 min	
Meat Loaf (1½ lbs/680 g)	100%	13 to 19 min	OTHER		
Chicken Pieces Internal temperature should be 185°F (85°C) after standing.	100%	6 to 9 min/lb	FOOD	COOK POWER	TIME
Turkey Breast Internal temperature should be 185°F (85°C) after standing.	100% then 70%	5 min 8 to 12 min/lb	Applesauce (4 servings)	100%	7 to 10 min
Fish Fillets (1 lb/454 g)	100%	5 to 6 min	Baked Apples (4)	100%	4 to 6 min
Scallops and Shrimp (1 lb/454 g)	100%	3½ to 5½ min	Chocolate (melt 1 square)	50%	1 to 2 min
VEGETABLES Cook at 100% cook power.			Eggs, Scrambled (2)	100%	1 min 15 sec to 1 min 45 sec
FOOD	TIME		(4)		2 to 3 min
Beans, Green or Yellow (1 lb/454 g)	6 to 12 min		Hot Cereals (1 serving) (4 servings)	100%	1½ to 5 min 4½ to 7 min
Broccoli (1 lb/454 g)	6 to 10 min		Nachos (large plate)	50%	1½ to 2½ min
Carrots (1 lb/454 g)	8 to 12 min		Water for Beverage (1 cup/227 mL) (2 cups/445 mL)	100%	2½ to 4 min 4½ to 6 min

Microwave cooking tips

Amount of food

- **If you increase or decrease** the amount of food you prepare, the time it takes to cook that food will also change. For example, if you double a recipe, add a little more than half the original cooking time. Check for doneness and, if necessary, add more time in small increments.

Starting temperature of food

- **The lower the temperature** of the food being put into the microwave oven, the longer it takes to cook. Food at room temperature will be reheated more quickly than food at refrigerator temperature.

Composition of food

- **Food with a lot of fat and sugar** will be heated faster than food containing a lot of water. Fat and sugar will also reach a higher temperature than water in the cooking process.
- **The more dense the food**, the longer it takes to heat. "Very dense" food like meat takes longer to reheat than lighter, more porous food like sponge cakes.

Size and shape

- **Smaller pieces of food** will cook faster than larger pieces and same-shaped pieces of food cook more evenly than irregularly shaped foods.
- **With unevenly shaped foods**, the thinner parts will cook faster than the thicker areas. **Place** the thinner parts of chicken wings and legs in the center of the dish.

Stirring, turning foods

- **Stirring and turning foods** distributes heat quickly to the center of the dish and avoids overcooking at the outer edges of the food.

Covering food

Cover food to:

- **Reduce** splattering
- **Shorten** cooking times
- **Retain** food moisture

All coverings that allow microwaves to pass through are suitable.

Releasing pressure in foods

- **Several foods** (for example: baked potatoes, sausages, egg yolks, and some fruits) are tightly covered by a skin or membrane. This can cause the food to burst from steam building up in them during cooking. To relieve the pressure and to prevent bursting, **pierce** these foods before cooking with a fork, cocktail pick, or toothpick.

Using standing time

- **Always allow food to stand** for a while after cooking. Standing time after defrosting, cooking, or reheating always improves the result since the temperature will then be evenly distributed throughout the food.
- **The length of the standing time** depends on the volume and density of the food. Sometimes it can be as short as the time it takes you to remove the food from the oven and take it to the serving table. However, with larger, denser food, the standing time may be as long as 10 minutes.

Arranging food

For best results, distribute food evenly on the plate. You can do this in several ways:

- **If you are cooking several items of the same food**, such as baked potatoes, **place** them in a ring pattern for uniform cooking.
- **When cooking foods of uneven shapes or thickness, such as chicken breasts**, **place** the smaller or thinner area of the food towards the center of the dish where it will be heated last.
- **Layer** thin slices of meat on top of each other.
- **When you cook or reheat whole fish**, **score** the skin – this prevents cracking. Shield the tail and head of whole fish with small pieces of foil to prevent overcooking and ensure the foil does not touch the sides of the oven.
- **Do not** let food or container touch the top or sides of the oven. This will prevent possible arcing.

Using aluminum foil

Metal containers should not be used in a microwave oven. There are, however, some exceptions. If you have purchased food which is prepackaged in an aluminum foil container, then refer to the instructions on the package. When using aluminum foil containers, cooking times may be longer because microwaves will only penetrate the top of the food.

If you use aluminum containers without package instructions, follow these guidelines:

- **Place** container in a glass bowl and add some water so that it covers the bottom of the container, not more than ¼ inch (6 mm) high. This ensures even heating of the container bottom.
- **Always remove** the lid to avoid damage to the oven.
- **Use only** undamaged containers.
- **Do not use** containers taller than ¾ inch (19 mm).
- **Container must be** half filled.
- **To avoid arcing**, there must be a minimum ¼ inch (6 mm) between the aluminum container and the walls of the oven and also between two aluminum containers.
- **Reheating food** in aluminum foil containers usually takes up to double the time compared to reheating in plastic, glass, china, or paper containers. The time when food is ready will vary a great deal.
- **Let food stand** for 2 to 3 minutes after heating so that heat is spread evenly throughout container.

Cooking you should not do in your microwave oven

- **Do not** do canning of foods in the oven. Closed glass jars may explode, resulting in damage to the oven or possible personal injury.
- **Do not** use the microwave oven to sterilize objects (baby bottles, etc.). It is difficult to maintain the high temperature required for safe sterilization.

Questions and Answers

QUESTIONS	ANSWERS
Can I operate my microwave oven without the turntable or turn the turntable over to hold a large dish?	No. If you remove or turn over the turntable, you will get poor cooking results. Dishes used in your oven must fit on the turntable.
Can I use a rack in my microwave oven so that I may reheat or cook on two levels at a time?	You can use a rack only if the rack is supplied with your microwave oven. Use of any rack not supplied with the microwave oven can result in poor cooking performance and/or arcing.
Can I use either metal or aluminum pans in my microwave oven?	Useable metal includes aluminum foil for shielding (use small, flat pieces), small skewers, and shallow foil trays (if tray is not taller than ¾ inch [19 mm] deep and at least half filled with food to absorb microwave energy). Never allow metal to touch walls or door. (For more information, see the “Microwave cooking tips” section.)
Is it normal for the turntable to turn in either direction?	Yes. The turntable rotates clockwise or counterclockwise, depending on the rotation of the motor when the cooking cycle begins.
Sometimes the door of my microwave oven appears wavy. Is this normal?	This appearance is normal and does not affect the operation of your oven.
What are the humming noises that I hear when my microwave oven is operating?	You hear the sound of the transformer when the magnetron tube cycles on.
Why does the dish become hot when I microwave food in it? I thought that this should not happen.	As the food becomes hot it will conduct the heat to the dish. Be prepared to use hot pads to remove food after cooking.
What does “standing time” mean?	“Standing time” means that food should be removed from the oven and covered for additional time to allow it to finish cooking. This frees the oven for other cooking.
Can I pop popcorn in my microwave oven? How do I get the best results?	Yes. Pop packaged microwave popcorn following manufacturer’s guidelines or use the preprogrammed POPCORN pad. Do not use regular paper bags. Use the “listening test” by stopping the oven as soon as the popping slows to a “pop” every 1 or 2 seconds. Do not repop unpopped kernels. You can also use special microwave poppers. When using a popper, be sure to follow manufacturer’s directions. Do not pop popcorn in glass cookware.
Why does steam come out of the air exhaust vent?	Steam is normally produced during cooking. The microwave oven has been designed to vent this steam out the top vent.

Troubleshooting

This section is designed to help you save the cost of a service call. This section outlines possible problems, their causes, and actions you can take to solve each problem.

Before calling for assistance ...

Performance problems often result from little things you can find and fix without tools of any kind. Please check the chart below for problems you can fix. It could save you the cost of a service call.

PROBLEM	POSSIBLE CAUSE	SOLUTION
Nothing will operate	<p>The unit is not wired into a live circuit with the proper voltage.</p> <p>A household fuse has blown or a circuit breaker has tripped.</p> <p>The electric company has experienced a power failure.</p>	<p>Contact a qualified service technician to wire unit into a live circuit with the proper voltage. (See Installation Instructions.)</p> <p>Replace household fuse or reset circuit breaker.</p> <p>Check electric company for a power failure.</p>
The microwave oven will not run	<p>You are using the oven as a timer.</p> <p>The door is not firmly closed and latched.</p> <p>You did not touch START/ENTER.</p> <p>You did not follow directions exactly.</p> <p>An operation that was programmed earlier is still running.</p>	<p>Touch TIMER OFF to cancel the Minute Timer.</p> <p>Firmly close and latch door.</p> <p>Touch START/ENTER.</p> <p>Check instructions for the function you are operating.</p> <p>Touch OFF/CANCEL to cancel previous programming.</p>
Microwave cooking times seem too long	<p>The electric supply to your home or wall outlets is low or lower than normal.</p> <p>The cook power is not at the recommended setting.</p> <p>Larger amounts of food need longer cooking times.</p>	<p>Your electric company can tell you if the line voltage is low. Your electrician or service technician can tell you if the outlet voltage is low.</p> <p>Check "Microwave cooking chart" on page 49.</p> <p>Allow for more time when cooking more food at one time.</p>

continued on next page

TROUBLESHOOTING

PROBLEM	POSSIBLE CAUSE	SOLUTION
The Display shows a time counting down but the oven is not cooking	The oven door is not closed completely. You have set the controls as a Minute Timer.	Completely close oven door. Touch TIMER OFF to cancel the Minute Timer.
The turntable will not turn	The turntable is not correctly in place. The support is not operating correctly.	Make sure the turntable is correct-side up and is sitting securely on center shaft. Remove turntable and restart oven. If turntable support does not move, call an authorized service technician for repair. Cooking without the turntable can give you poor results.
You do not hear the Programming Tone	The command is not correct.	Re-enter command.
The Display shows "88:88"	There has been a power interruption.	Reset the clock.

Requesting Assistance or Service

Before calling for assistance or service, please check the "Troubleshooting" section. It may save you the cost of a service call. If you still need help, follow the instructions below.

If you need assistance or service in the U.S.A.:

1. If the problem is not due to one of the items listed in "Troubleshooting"† ...

Call the Whirlpool Consumer Assistance Center telephone number. Dial toll-free from anywhere in the U.S.A.:



1-800-253-1301

and talk with one of our trained consultants. The consultant can instruct you in how to obtain satisfactory operation from your appliance or, if service is necessary, recommend a qualified service company in your area.

If you prefer, write to:

Whirlpool Brand Home Appliances
Consumer Assistance Center
c/o Correspondence Dept.
2000 North M-63
Benton Harbor, MI 49022-2692

Please include a daytime phone number in your correspondence.

2. If you need service† ...

Whirlpool has a nationwide network of authorized Whirlpool service companies. Whirlpool service technicians are trained to fulfill the product warranty and provide after-warranty service, anywhere in the United States. To locate the authorized Whirlpool service company in your area, call our Consumer Assistance Center telephone number (see Step 1) or look in your telephone directory Yellow Pages under:



• **APPLIANCE-HOUSEHOLD-MAJOR, SERVICE & REPAIR**

- See: Whirlpool Appliances or Authorized Whirlpool Service
(Example: XYZ Service Co.)

• **WASHING MACHINES & DRYERS, SERVICE & REPAIR**

- See: Whirlpool Appliances or Authorized Whirlpool Service
(Example: XYZ Service Co.)

† When asking for help or service: Please provide a detailed description of the problem, your appliance's complete model and serial numbers, and the purchase date. (See the "A Note to You" section.) This information will help us respond properly to your request.

If you need assistance or service in Canada:

1. If the problem is not due to one of the items listed in "Troubleshooting"† ...

Contact the dealer from whom you purchased your appliance, or call the Inglis Limited Consumer Assistance Centre toll free, **8:30 a.m. – 6 p.m. (EST), at 1-800-461-5681.**



2. If you need service† ...

Contact your nearest Inglis Limited Appliance Service branch or authorized servicing outlet to service your appliance. (See list below.)

† When asking for help or service: Please provide a detailed description of the problem, your appliance's complete model and serial numbers, and the purchase date. (See the "A Note to You" section.) This information will help us respond properly to your request.

Inglis Limited Appliance Service – Consumer Services

Direct service branches:

BRITISH COLUMBIA		1-800-665-6788
ALBERTA		1-800-661-6291
ONTARIO (except 807 area code)	Ottawa area Outside the Ottawa area	1-800-267-3456 1-800-807-6777
MANITOBA, SASKATCHEWAN and 807 area code in ONTARIO		1-800-665-1683
QUEBEC	Montreal (except South Shore) South Shore Montreal Quebec City Sherbrooke	1-800-361-3032 1-800-361-0950 1-800-463-1523 1-800-567-6966
ATLANTIC PROVINCES		1-800-565-1598

For further assistance

If you need further assistance, you can write to Inglis Limited with any questions or concerns at:

Consumer Relations Department
Inglis Limited
1901 Minnesota Court
Mississauga, Ontario L5N 3A7

Please include a daytime phone number in your correspondence.

WHIRLPOOL* (U.S.A.) Microwave Oven Warranty

LENGTH OF WARRANTY	WHIRLPOOL WILL PAY FOR
FULL ONE-YEAR WARRANTY FROM DATE OF PURCHASE	FSP* replacement parts and repair labor to correct defects in materials or workmanship. Service must be provided by an authorized Whirlpool service company.
LIMITED FOUR-YEAR WARRANTY SECOND THROUGH FIFTH YEAR FROM DATE OF PURCHASE	FSP replacement magnetron tube on microwave ovens if defective in materials or workmanship.
WHIRLPOOL WILL NOT PAY FOR	
<p>A. Service calls to:</p> <ol style="list-style-type: none"> 1. Correct the installation of your microwave oven. 2. Instruct you how to use your microwave oven. 3. Replace house fuses or correct house wiring. 4. Replace owner-accessible light bulbs. <p>B. Repairs when your microwave oven is used in other than normal, single-family household use.</p> <p>C. Pickup and delivery. Your microwave oven is designed to be repaired in the home.</p> <p>D. Damage to your microwave oven caused by accident, misuse, fire, flood, acts of God, or use of products not approved by Whirlpool.</p> <p>E. Any labor costs during limited warranty.</p> <p>F. Repairs to parts or systems resulting from unauthorized modifications made to the appliance.</p>	

9/97

WHIRLPOOL CORPORATION SHALL NOT BE LIABLE FOR INCIDENTAL OR CONSEQUENTIAL DAMAGES. Some states do not allow the exclusion or limitation of incidental or consequential damages, so this exclusion or limitation may not apply to you. This warranty gives you specific legal rights, and you may also have other rights which vary from state to state.

Outside the United States, a different warranty may apply. For details, please contact your authorized Whirlpool dealer.

If you need assistance or service, first see the "Troubleshooting" section of this book. After checking "Troubleshooting," additional help can be found by checking the "Requesting Assistance or Service" section. In the U.S.A., call the Whirlpool Consumer Assistance Center at **1-800-422-1230**.

For warranty information in Canada:

Please contact your authorized Whirlpool dealer or call the Consumer Assistance Centre at **1-800-461-5681** (toll free) between 8:30 a.m. and 6 p.m. EST from anywhere in Canada.

For service or assistance in Canada:

If you need assistance or service in Canada, first see the "Troubleshooting" section of this book. After checking "Troubleshooting," additional help can be found by checking the "Requesting Assistance or Service" section.

3828W5A0525/4359626

© 1997 Whirlpool Corporation

* Trademark of Whirlpool, U.S.A., Inglis Limited licensee in Canada

9/97

Printed in Korea