

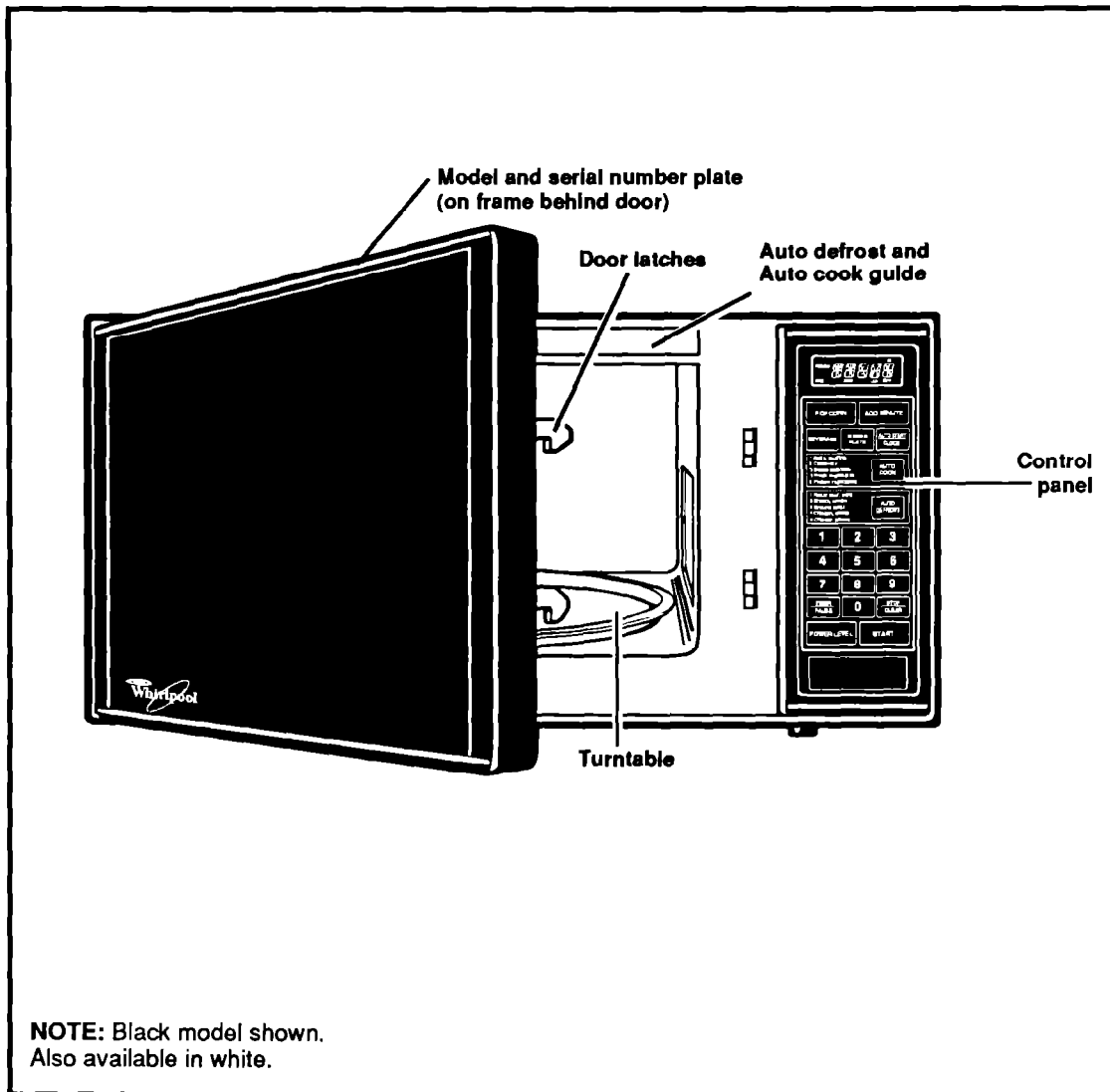

Use & Care Guide



NOTE: Black model shown.
Also available in white.

**MICROWAVE OVENS
MT6900XW MT6901XW**

Contents

	Page
Important Safety Instructions	3
Precautions To Avoid Possible Exposure To Excessive Microwave Energy	4
Getting Acquainted	5
Microwave oven features	5
Control panel features	6
Quick reference cooking guide	7
Using Your Microwave Oven	10
Microwave oven controls	10
Setting the clock	11
Using the Minute Timer	11
Using STOP/CLEAR	12
Cooking with your microwave oven	12
Cooking at high cook power	12
Cooking at lower cook powers	13
Using AUTO COOK	14
Auto cook chart	15
Defrosting	16
Auto defrost chart	17
Cooking with more than one cook cycle	18
One-Touch Cooking	20
Using ADD MINUTE	21
Using PAUSE	22
Using AUTO START	23
Installation Instructions	24
Installing your microwave oven	24
Grounding instructions	25
Caring For Your Microwave Oven	26
Cleaning the microwave oven	26
How Your Microwave Oven Works	27
Operating Safety Precautions	28
Cooking Guide	32
Reheating chart	32
Microwave cooking chart	33
Questions And Answers	34
If You Need Service Or Assistance	35
Whirlpool Microwave Oven Warranty	36

© 1991 Whirlpool Corporation

Thank you for buying a Whirlpool appliance. Please complete and mail the Owner Registration Card provided with this product. Then complete the form below. Have this information ready if you need service or call with a question.

- Copy model and serial numbers from plate (behind the microwave oven door on the frame) and purchase date from sales slip.
- Keep this book and the sales slip together in a handy place.

Model Number

Serial Number

Purchase Date

Service Company Phone Number

Fill out and return the Microwave Registration Card included with your microwave oven. If the card is missing, please send the model and serial number of your microwave oven, with your name and address to ...

Whirlpool Corporation
 Microwave Registration Department
 Administrative Center
 2000 M-63
 Benton Harbor, MI 49022

This information will help us reach you if there is ever a need to pass along information about your microwave oven.

IMPORTANT SAFETY INSTRUCTIONS

Microwave ovens have been thoroughly tested for safe and efficient operation. However, as with any appliance, there are special installation and safety precautions which must be followed to ensure safe and satisfactory operation and prevent damage to the unit.

⚠ WARNING

To reduce the risk of fire, electrical shock, injury to persons, or damage when using the microwave oven, follow basic precautions, including the following:

- Read all instructions before using the microwave oven.
- Read and follow the specific "PRECAUTIONS TO AVOID POSSIBLE EXPOSURE TO EXCESSIVE MICROWAVE ENERGY" found on page 4.
- This appliance must be grounded. Connect only to properly grounded outlet. See "GROUNDING INSTRUCTIONS" found on page 25.
- Install or locate this appliance only in accordance with the provided Installation Instructions found on page 24.
- Some products such as whole eggs and sealed containers—for example, closed glass jars—may explode and should not be heated in this oven.
- Use this appliance only for its intended use as described in this manual. Do not use corrosive chemicals or vapors in this appliance. This type of oven is specifically designed to heat, cook, or dry food. It is not designed for industrial or laboratory use.
- As with any appliance, close supervision is necessary when used by children.
- Do not operate this appliance if it has a damaged cord or plug, if it is not working properly, or if it has been damaged or dropped. Electrical shock, fire or other hazards may result.
- This appliance should be serviced only by qualified service personnel. Call an authorized WhirlpoolSM service company for examination, repair or adjustment.
- Do not cover or block any opening on the appliance. Fire may result.
- Do not store or use this appliance outdoors. Do not use this product near water—for example, near a kitchen sink, in a wet basement, or near a swimming pool, and the like.
- Do not immerse cord or plug in water. Electrical shock may result.
- Keep cord away from heated surfaces. Electrical shock may result.
- Do not let cord hang over edge of table or counter. Electrical shock may result.
- See door surface and interior cleaning instructions on page 26.
- To reduce the risk of fire in the oven cavity:
 - Do not overcook food. Carefully attend appliance if paper, plastic, or other combustible materials are placed inside the oven to facilitate cooking. Paper can char or burn, and some plastics can melt if used when heating foods.
 - Do not deep fry in oven.
 - **Test dinnerware or cookware before using.** See page 31. Some dishes (melamine, Centura[®], etc.) absorb microwave energy, becoming too hot to handle and slowing cooking times. Remove wire twist-ties from paper or plastic bags before placing bag in oven. Cooking in metal containers not designed for microwave use can damage the oven, as can containers with hidden metal (twist-ties, foil lining, staples, metallic glaze or trim.)
 - If materials inside the oven should ignite, keep oven door closed, turn oven off, and disconnect the power cord, or shut off power at the fuse or circuit breaker panel.
 - Do not use the cavity for storage purposes. Do not leave paper products, cooking utensils, or food in the cavity when not in use.
- Read and follow "Operating Safety Precautions" starting on page 28.
- 1. A short power-supply cord is provided to reduce the risks resulting from becoming entangled in or tripping over a longer cord.
- 2. Longer cord sets or extension cords are available and may be used if care is exercised in their use.
- 3. If a long cord or extension cord is used, (a) the marked electrical rating of the cord set or extension cord should be at least as great as the electrical rating of the appliance, (b) the extension cord must be a grounding-type, 3-wire cord, and (c) the longer cord should be arranged so that it will not drape over the countertop or tabletop where it can be pulled on by children or tripped over accidentally.

– SAVE THESE INSTRUCTIONS –

You are responsible for:

- Installing and leveling the oven on a surface strong enough to support its weight, and where it is protected from the elements.* The microwave oven should be at a temperature above 50°F (10°C) for proper operation.
- Properly connecting the oven to electrical supply and grounding it.*
- Making sure the oven is not used by anyone unable to operate it properly.
- Properly maintaining the oven.
- Using the microwave oven only for jobs expected of a home microwave oven.

*See the Installation Instructions on page 24.

PRECAUTIONS TO AVOID POSSIBLE EXPOSURE TO EXCESSIVE MICROWAVE ENERGY...

Do not attempt to operate this oven with the door open since open-door operation can result in harmful exposure to microwave energy. It is important not to defeat or tamper with the safety interlocks.

Do not place any object between the oven front face and the door or allow soil or cleaner residue to accumulate on sealing surfaces.

Do not operate the oven if it is damaged. It is particularly important that the oven door close properly and that there is no damage to the:

- (1) Door (bent),
- (2) Hinges and latches (broken or loosened),
- (3) Door seals and sealing surfaces.

Do not operate the microwave oven if the door window is broken.

The microwave oven should be checked for microwave leakage by qualified service personnel after a repair is made.

The oven should not be adjusted or repaired by anyone except properly qualified service personnel.

Do not operate the microwave oven with the outer cabinet removed.

Getting Acquainted

Microwave oven features

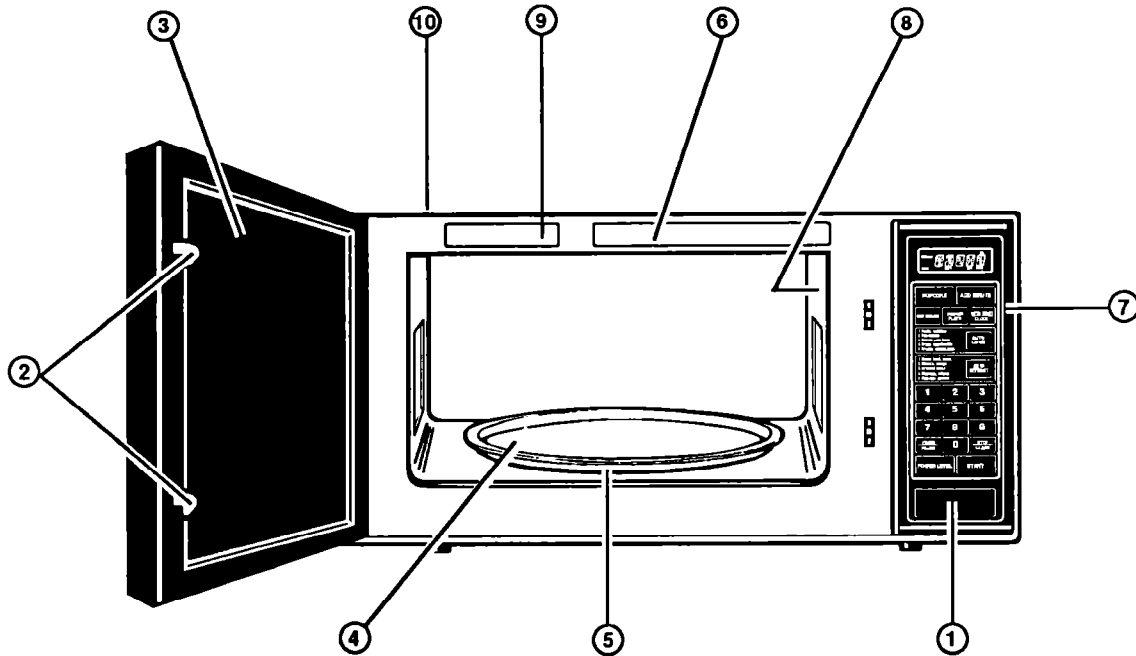

Your microwave oven is designed to make your cooking experience as enjoyable and productive as possible. To help get you up and running quickly, the following is a list of the oven's basic features:

- 1. One-Touch Door Open Button.** Push to open door.
- 2. Door Safety Lock System.** The oven will not operate unless the door is securely closed.
- 3. Window with Metal Shield.** Shield prevents microwaves from escaping. It is designed as a screen to allow you to view food as it cooks.
- 4. Glass Turntable.** This turntable turns food as it cooks for more even cooking. It must be in oven during operation for best cooking results. See page 30 for more details.
- 5. Removable Turntable Support** (under turntable).
- 6. Auto Defrost and Auto Cook Guide.**
- 7. Control Panel.** Touch pads on this panel to perform all functions. See page 6 for more details.
- 8. Light.** Automatically turns on when door is opened or when oven is operating.
- 9. Model and Serial Number Plate.**
- 10. External Oven Air Vents** (on back). See page 24 for more details.

Control panel features

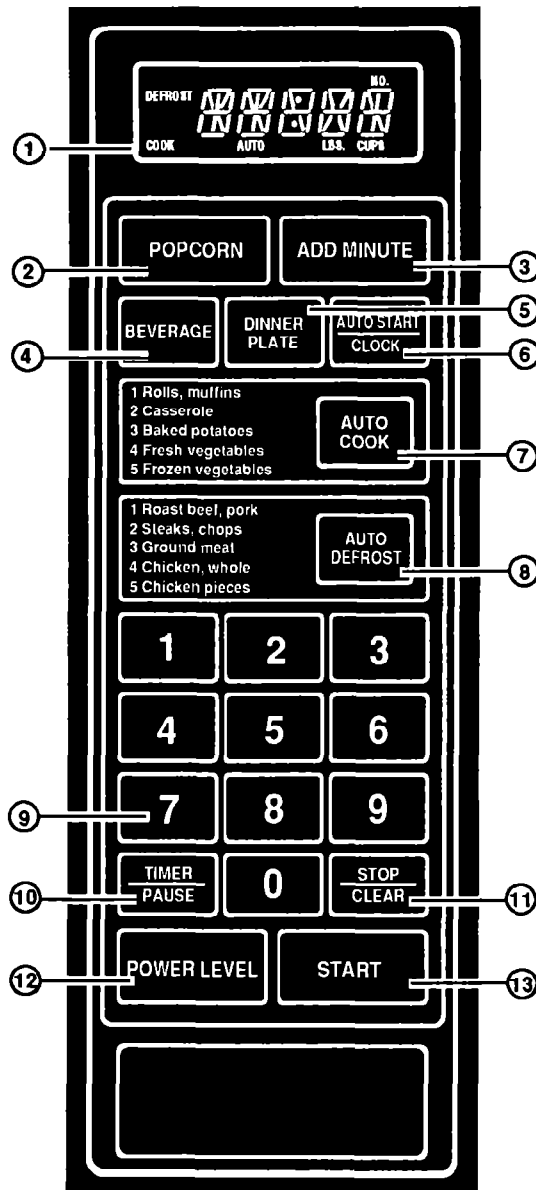

Your microwave oven control panel lets you select the desired cooking function quickly and easily. All you have to do is touch the necessary Command Pad. The following is a list of all the Command and Number Pads located on the control panel. For more information, see pages 10-23.

Audible signals are available to guide you when setting and using your oven. A programming tone will sound each time you touch a pad. A single, long tone signals the end of a cooking or Minute Timer function. If you do not hear a tone, it is because of incorrectly entered instructions.

- 1. Display.** This display includes clock and indicators to tell you time of day, cooking time settings and cooking functions selected. See page 10 for more information.
- 2. POPCORN.** Touch this pad when popping popcorn in your microwave oven. The oven will automatically heat for a preset time at a preset cook power. See page 20 for more information.
- 3. ADD MINUTE.** Touch this pad to add an extra minute, at 100% Cook Power, to your cooking cycle. See page 21 for more information.
- 4. BEVERAGE.** Touch this pad when heating a beverage in your microwave oven. The oven will automatically heat for a preset time at a preset cook power. See page 20 for more information.
- 5. DINNER PLATE.** Touch this pad when heating a plate of food in your microwave oven. The oven will automatically heat for a preset time at a preset cook power. See page 20 for more information.
- 6. AUTO START/CLOCK.** Touch this pad to enter the correct time of day or to program your oven to begin cooking automatically at a designated time later in the day. See pages 11 and 23 for more information.
- 7. AUTO COOK.** Touch this pad to cook common microwave-prepared foods without needing to program times or cook powers. See page 14 for more information.
- 8. AUTO DEFROST.** Touch this pad followed by Number Pads to thaw frozen food before cooking. See page 16 for more information.
- 9. Number Pads.** Touch Number Pads to enter cooking times, Cook Powers, quantities or weights.

10. **TIMER/PAUSE.** Touch this pad to set the Minute Timer or to stop the oven between cooking stages. See pages 11 and 22 for more information.
11. **STOP/CLEAR.** Touch this pad once to erase an incorrect command, cancel the Minute Timer or stop the oven temporarily during cooking. Touch it twice to cancel a program during cooking or to clear the Display. See page 12 for more information.
12. **POWER LEVEL.** Touch this pad followed by a Number Pad to set the amount of microwave energy released to cook the food. The higher the number, the higher the power or "heat." See page 13 for more information. See the "Microwave cooking chart" on page 33 for specific Cook Powers to use for the foods you are cooking.
13. **START.** Touch this pad after setting a function on the microwave oven to start the function. If you open the door before the oven begins to cook, retouch START.



Quick reference cooking guide







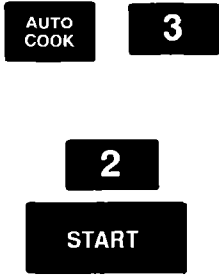
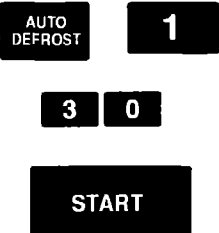
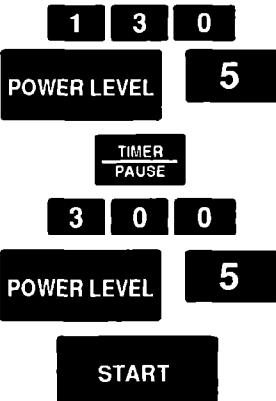







Your microwave oven gives you a wide range of cooking capabilities. The following chart can be used as a quick reference when cooking. For more in-depth information, see the corresponding sections in this Use and Care Guide.

If you want to ...	You ...	Example ...
<p>Set the clock Setting the clock to the correct time of day lets you set start times with the Auto Start feature. The microwave clock also provides an accurate source of time for your kitchen.</p>	<ol style="list-style-type: none"> 1. Touch STOP/CLEAR. 2. Touch AUTO START/CLOCK. 3. Enter the correct time of day by touching the necessary Number Pads. 4. Touch AUTO START/CLOCK again. 	
<p>Use the Minute Timer The Minute Timer lets you time any cooking activities in your kitchen.</p>	<ol style="list-style-type: none"> 1. Touch Number Pads to enter the desired time. 2. Touch TIMER/PAUSE. 3. To clear the Minute Timer, touch STOP/CLEAR. 	
<p>Cook at high power High power cooking is perfect for quick cooking of small items and separate portions.</p>	<ol style="list-style-type: none"> 1. Put food in the oven and close the door. 2. Touch Number Pads for the cooking time you want. 3. Touch START. 	
<p>Cook at lower powers Cooking at lower powers is necessary for efficient cooking of most foods. Failure to use the correct Cook Power may result in overcooking or undercooking.</p>	<ol style="list-style-type: none"> 1. Put food in the oven and close the door. 2. Touch Number Pads for the cooking time you want. 3. Touch POWER LEVEL. 4. Touch a Number Pad for the Cook Power you want. 5. Touch START. 	

continued on next page

**Getting Acquainted
Continued**

If you want to ...	You ...	Example ...
<p>Cook with Auto Cook Cooking with Auto Cook lets you cook common microwave-prepared foods without needing to program times and Cook Powers.</p>	<ol style="list-style-type: none"> Put food in the oven and close the door. Touch AUTO COOK. Select an Auto Cook setting. (See settings listed by the AUTO COOK Command Pad.) Touch the Number Pad that corresponds to the type of food being cooked. Touch a Number Pad to enter the quantity of food being cooked. See chart on page 15. Touch START. 	 <p>The diagram shows the following sequence of button presses: a rectangular button labeled 'AUTO COOK', a square button labeled '3', another square button labeled '2', and a larger rectangular button labeled 'START'.</p>
<p>Defrost Your microwave oven automatically defrosts a variety of common meats at preset Cook Powers for preset times.</p>	<ol style="list-style-type: none"> Put food in the oven and close the door. Touch AUTO DEFROST. Enter the desired Auto Defrost setting by touching the correct Number Pad. (See settings listed by the AUTO DEFROST Command Pad.) Touch Number Pads for the weight of the item to be defrosted. See chart on page 17. Touch START. 	 <p>The diagram shows the following sequence of button presses: a rectangular button labeled 'AUTO DEFROST', a square button labeled '1', two square buttons labeled '3' and '0', and a larger rectangular button labeled 'START'.</p>
<p>Cooking with more than one cook cycle Cooking with two or three cycles lets you cook at different Cook Powers, one after another. Using this function, you are able to fine-tune your cooking for better results.</p>	<ol style="list-style-type: none"> Put food in the oven and close the door. Touch Number Pads for the cooking time you want. Touch POWER LEVEL twice for 100% Cook Power, or POWER LEVEL followed by a Number Pad for a lower Cook Power in the first cycle. Touch TIMER/PAUSE if a pause is desired. Touch Number Pads for the cooking time you want in the second cycle. Touch POWER LEVEL and a Number Pad for the Cook Power you want in the second cycle. Touch START. 	 <p>The diagram shows the following sequence of button presses: three square buttons labeled '1', '3', and '0'; a rectangular button labeled 'POWER LEVEL' followed by a square button labeled '5'; a rectangular button labeled 'TIMER/PAUSE'; three square buttons labeled '3', '0', and '0'; another rectangular button labeled 'POWER LEVEL' followed by a square button labeled '5'; and finally a larger rectangular button labeled 'START'.</p>
<p>Operate One-Touch cooking One-Touch Cooking allows you to pop popcorn, heat a beverage or warm up a dinner plate by touching just one pad.</p>	<ol style="list-style-type: none"> Put food or beverage in the oven and close the door. Touch the One-Touch Cooking Command Pad of your choice. 	 <p>The diagram shows three rectangular buttons stacked vertically, labeled 'DINNER PLATE', 'POPCORN', and 'BEVERAGE'.</p>

If you want to ...	You ...	Example ...
<p>Add a minute to your cooking Touching ADD MINUTE lets you cook for a minute at 100% Cook Power.</p>	<p>1. Make sure food is in the oven and the door closed. 2. Touch ADD MINUTE.</p>	
<p>Pause during cooking Touching PAUSE allows you to stop the oven between cooking cycles to stir, turn food over or add ingredients during the cooking process.</p>	<p>1. Put food in oven and close the door. 2. Touch the desired Number Pads for the cooking time you want for the first cycle. 3. Touch POWER LEVEL twice for 100% Cook Power or once followed by a Number Pad for a lower Cook Power. 4. Touch TIMER/PAUSE. 5. Enter programming for the second cooking cycle. 6. Touch START.</p>	      
<p>Start cooking automatically at a later time The Auto Start feature is a handy way to start cooking a meal whenever you want, even when you are not there.</p>	<p>1. Put food in oven and close the door. 2. Touch Number Pads to enter the desired start time. 3. Touch AUTO START/CLOCK. 4. Touch Number Pads to enter the amount of cooking time you want. 5. Touch POWER LEVEL. 6. Touch the Number Pad for the Cook Power you want. 7. Touch START.</p>	     

Using Your Microwave Oven

Microwave oven controls

There are three parts in the control section:

- Display/Clock and Indicators
- Command Pads
- Number Pads

Instructions for each control are covered on the following pages. Read them carefully.

When you first plug in the oven, the Display will flash **88:88**. Touch **STOP/CLEAR** and “1:00” will appear. If, after you set the Clock (page 11), the Display again shows all 8's, it means your electricity was off for a while. Reset the Clock.

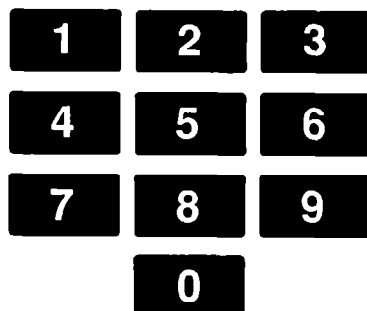
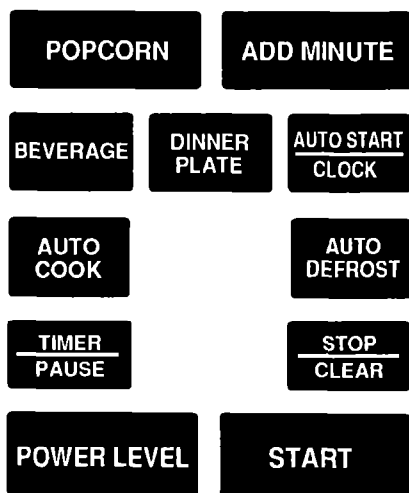

Display/clock and indicators

When you are not using the microwave oven, this is an accurate clock.

When you are using the microwave oven, it displays time settings, cook powers, and Indicators.

Command pads

- Touch Command Pads to tell the microwave oven what to do and in what order. A few examples:
 - **CLOCK** tells the oven you are going to set the clock.
 - **START** tells the oven to start.
- Each Command Pad (except **START**, **STOP/CLEAR**, **AUTO START/CLOCK** and **TIMER/PAUSE**) causes an Indicator to light when you touch the Command Pad. While the oven is running, an Indicator (or Indicators) will be on to show what the oven is doing.
- If you touch two instructions into the same cycle, the second set of instructions will cancel the first.

Number pads

Once you've touched a Command Pad to tell the oven what you want it to do, you'll touch Number Pads to tell it ...

- a time,
- a Cook Power.

Display messages

Messages will appear on the display to guide you with your cooking. If you attempt to enter unacceptable instructions, “**ERROR**” will appear in the Display. Touch **STOP/CLEAR** and re-enter the instructions.



AUTO START
CLOCK



3 2 5

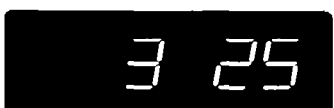

AUTO START
CLOCK



Setting the clock

When the oven is first plugged in, the Display flashes 88:88. If the electric power ever goes off, the Display will again flash all 8's when the power comes back on.

You can cook without setting the clock, but the Display will be blank after cooking.

1. Touch STOP/CLEAR, then touch AUTO START/CLOCK. The Display will show a "0".
2. Touch Number Pads for the correct time of day. The Display will show what numbers you touched **in the order you touched them**. This example shows 25 minutes after 3 o'clock.

3. Touch AUTO START/CLOCK. The Clock is set.

If you have touched in an incorrect time, such as 12:65, "ERROR" will show on the Display. Touch STOP/CLEAR, then touch AUTO START/CLOCK and start over.

NOTE: To **reset** the clock, touch AUTO START/CLOCK. The current time will show on the Display. Continue to set the clock as shown above.

Using the Minute Timer

Your microwave oven can be used as a kitchen timer. Use the Minute Timer for timing up to 99 minutes, 99 seconds.

1. Touch Number Pads for the minutes and seconds you want. The Display will show the numbers you touched **in the order you touched them**. This example shows 3 minutes.
2. Touch TIMER/PAUSE. The Display will count down to show you how much time is left. During the countdown the oven will be dark and the fan will be off.
3. When the set time ends, a long tone will sound. The Display will then show the time of day.

NOTE:

- To see the time of day while the Minute Timer is counting down, touch AUTO START/CLOCK.
- If you want to use other Command Pads while the Minute Timer is counting down, touch STOP/CLEAR to cancel the Minute Timer.

3 0 0

TIMER
PAUSE



Using STOP/CLEAR

Touch STOP/CLEAR once to:

- Erase instructions if you make a mistake during programming.
- Cancel the Minute Timer.
- Stop the oven temporarily during cooking.

Touch STOP/CLEAR twice to:

- Cancel a program during cooking.

NOTE: The oven may be stopped during a cycle by opening the door. Close the door and touch START to restart.

Cooking with your microwave oven

Although a new rating method* rates this oven at 800 watts, you may use a reliable cookbook and recipes developed for 650-700 watt microwave ovens.

Important things to remember to get the best cooking results:

- **ALWAYS** cook food for the minimum recommended cooking time. If necessary, add time in one or two minute periods, then check for doneness to avoid overcooking the food.
- Stir, turn over or rearrange the food being cooked about halfway through the cooking time for most even doneness with all recipes.
- If a glass cover is not available, use wax paper, paper towels or microwave-approved plastic wrap. Turn back a corner to vent steam during cooking.

*IEC-705 Test Procedure. The IEC-705 Test Procedure is an internationally recognized method of rating microwave wattage output and does not represent an actual change to output power or cooking performance.

Cooking at high cook power

Follow these steps to cook at **high power**:

1. Put food in the oven and close the door.
2. Touch Number Pads for the cooking time you want. The Display will show the numbers you touched **In the order you touched them**. The example shows 1 minute, 30 seconds.

NOTE: If programming more than one cycle, you must touch POWER LEVEL twice for 100% Cook Power. If programming only one cycle, you do not need to touch POWER LEVEL at all.

3. Touch START. The oven will automatically cook at high Cook Power. The COOK Indicator will come on to show that the oven is cooking. The Display counts down the time to show how much time is left in the cycle. When the cooking time ends, a long tone will sound. The Display will then show the time of day.



Cooking at lower cook powers

For best results, some recipes call for lower Cook Powers. The lower the Cook Power, the slower the cooking. Each Number Pad also stands for a different percentage of Cook Power. Many microwave cookbook recipes tell you by number, percent or name which Cook Power to use.

The following chart gives the percentage of Cook Power each Number Pad stands for, and Cook Power name usually used:

automatic 100% of full power HIGH

9 = 90% of full power

8 = 80% of full power

7 = 70% of full power MED-HIGH

6 = 60% of full power

5 = 50% of full power MED

4 = 40% of full power

3 = 30% of full power MED-LOW

2 = 20% of full power

1 = 10% of full power LOW

0 = 0% of full power (fan and light will be on)

1. Put food in the oven and close the door.
2. Touch Number Pads for the cooking time you want. The Display will show the numbers you touched in the order you touched them. This example shows 7 minutes, 30 seconds.



3. Touch POWER LEVEL. The Display will show "P-".
4. Touch a Number Pad for the Cook Power you want. The Display will show what you touched. This example shows you touched Number Pad 5 for 50% of full power.
5. Touch START. The COOK Indicator will come on to show that the oven is cooking. The Display counts down the time to show how much cooking time is left in the cycle. When the cooking time ends, a long tone will sound. The Display will then show the time of day.

Using AUTO COOK

Cooking with Auto Cook lets you cook common microwave-prepared foods without needing to program times and cook powers. Auto Cook has preset times and cook powers for five major food categories: Rolls, muffins; Casserole; Baked potatoes; Fresh vegetables and Frozen vegetables. All you do is touch the Number Pad assigned to the desired category and enter the number of items being heated. Your microwave oven does the rest.

1. Put the food in the oven and close the door.
2. Touch AUTO COOK. "FOOD" will flash on the Display.



3. Touch a Number Pad (1-5) to select an Auto Cook setting. See the chart next to the AUTO COOK Command Pad on the control panel. The Display will show "CC" (Computerized Cooking) for the setting you selected and the "NO." or "CUPS" Indicator will flash. This example shows an entry of "1" for Rolls, muffins.
4. Touch a Number Pad to enter the amount of items to be heated. The amount will appear on the Display. This example shows an entry of "2" for two items.
5. Touch START. The COOK Indicator will come on to show that the oven is cooking. When the cooking time ends, a long tone will sound. The Display will then show the time of day.

Auto cook chart

SETTING	AMOUNT	PROCEDURE
1 Rolls, muffins	1-6 pieces	Arrange on a double layer of paper towels; cover with another towel.
2 Casserole	1-4 cups	To reheat, flatten on plate or place in bowl. Cover with vented plastic wrap. Stir before serving, if possible.
3 Baked potatoes	1-6 med. size	Prick; place on paper towel directly on turntable. After cooking, remove from oven and let stand wrapped in foil 5 minutes.
4 Fresh vegetables	1-4 cups	Place in a microwave-safe container. For beans, carrots, corn, and peas, add 1 tablespoon water per cup. For broccoli, brussels sprouts, cabbage and cauliflower, cook immediately after washing with no additional water. If you like tender-crisp vegetables, set the Auto Cook quantity for half the amount of vegetables you are actually cooking. For example, when cooking 2 cups of vegetables, set Auto Cook for 1 cup. Cover with lid or plastic wrap. After cooking, remove from oven, stir, cover and let stand 3 to 5 minutes before serving.
5 Frozen vegetables	1-4 cups	Place in a microwave-safe container. Cover with lid or plastic wrap. After cooking remove from oven, stir, cover and let stand 3 minutes before serving.

NOTE:

- If you enter an amount not shown in the chart above, "ERROR" will appear. Auto Cook will only operate with the amounts shown.
- When cooking a 10 oz package of frozen vegetables (this equals about 1 ½ cups), touch "1" for 1 cup of "tender crisp" vegetables (you cannot enter ½ cup amounts) or touch "2" for two cups of vegetables more fully cooked.

Defrosting

Your microwave oven automatically defrosts a variety of common meats at preset cook powers for preset times. The 3-stage Auto Defrost Cycle is programmed for: Roast beef, pork; Steaks, chops; Ground meat; Chicken, whole; and Chicken pieces. All you do is touch the Number Pad assigned to the desired category and enter the weight of the items being heated. Your microwave oven does the rest.

1. Put frozen food in the oven and close the door.
2. Touch AUTO DEFROST. The DEFROST Indicator will come on and "FOOD" will flash on the Display.



3. Select an Auto Defrost setting by touching the appropriate Number Pad. The Display will show CD (Computerized Defrosting) for the setting you selected and the "LBS." Indicator will flash. This example shows an entry of "2" for Steaks, chops.

4. Touch Number Pads to enter the food's weight. The weight will appear on the Display. This example shows an entry of "2.0" for two pounds.

NOTE: If "ERROR" appears on the display, touch STOP/CLEAR and start over. See the "Auto defrost chart" on page 17 for weight ranges available for each food category.

5. Touch START. The COOK Indicator will come on to show that the oven is defrosting. The Display will count down the time to show how much defrosting time is left.

6. After the first stage is completed, the oven will stop, 4 tones will sound, and directions will appear on the Display. Open the door, turn meat over and shield any warm portions. (The Displays shown are just examples of directions you will see, depending on the type of meat being thawed.) Close the door. "PRESS START" will appear.

7. Touch START. The Display will continue to count down the second stage of the defrost cycle.

CHEK

COVER EDGE

PRESS START

START DEFROST 2.40 COOK

COVER STAND

8. After the second stage is completed, the oven will stop, 4 tones will sound, and directions will appear on the Display. Open the door, shield any warm portions and close the door. "PRESS START" will appear.

9. Touch START to complete defrosting.

10. After defrosting, the oven will stop and directions will appear on the Display. Open the door or touch STOP/CLEAR. The Display will then show the time of day.

Auto defrost chart

SETTING	AMOUNT	PROCEDURE
1 Roast beef, pork	2.5-6.0 lbs	After 1st stage, turn over and shield the warm portions with aluminum foil. After the 2nd stage, turn over and if there are warm portions, shield with aluminum foil. Stand, covered 30-60 minutes.
2 Steaks, chops, fish	0.5-4.0 lbs	After the 1st stage, turn over and shield the warm portions with aluminum foil. After the 2nd stage, if there are warm portions, shield with aluminum foil. Stand, 10-15 minutes.
3 Ground meat	0.5-3.0 lbs	Remove any thawed parts after each stage. Stand, 5-10 minutes.
4 Chicken, whole	2.5-6.0 lbs	Remove giblets before freezing poultry for more uniform defrosting. After the 1st stage, turn over and shield the warm portions with aluminum foil. After the 2nd stage, if there are warm portions, shield with aluminum foil. Stand, covered 30-55 minutes.
5 Chicken pieces	0.5-3.0 lbs	After the 1st stage, turn over and rearrange. After the 2nd stage, if there are warm or thawed portions, rearrange or remove. Stand, 10-15 minutes.

NOTE:

- If you enter an amount not shown in the chart above, "ERROR" will appear. Auto Defrost will only operate within the weight ranges shown in the chart. Round weights of food items to the nearest half pound.
- To defrost items not listed in Auto Defrost, use 30% Cook Power. See a reliable cookbook for defrosting information.



Cooking with more than one cook cycle

For best results, some recipes call for one Cook Power for a certain length of time, and another Cook Power for another length of time. Your oven can be set to change from one to another automatically.

1. Put food in the oven and close the door.
2. Touch Number Pads for the cooking time you want. The display will show the numbers you touched **in the order you touched them**. This example shows 7 minutes, 30 seconds.

3. Select a Cook Power.

- To cook at full (100%) power, touch POWER LEVEL twice. The display will show "P-HI". This shows the oven is programmed to cook at full power.

- To select another Cook Power, touch POWER LEVER once, followed by a Number Pad for the Cook Power you want in the first cycle. This example shows you touched Number Pad 5 for 50% of full power.

4. Touch Number Pads for the cooking time you want in the second cycle. The Display will show the numbers you touched in the order you touched them. This example shows 3 minutes, 25 seconds.

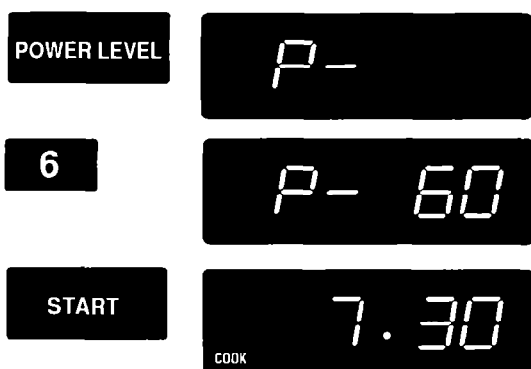

5. Select a Cook Power.

- To cook at full (100%) power, skip to Step 6.
- To cook at another Cook Power, touch POWER LEVEL once followed by a Number Pad for the Cook Power you want in the second cycle. This example shows you touched Number Pad 6 for 60% of full power.

6. Touch START. The Cook Indicator will come on and the Display counts down the time to show how much cooking time is left in each cycle. When the cooking time ends, a long tone will sound. The Display will then show the time of day.

Changing or adding instructions

You can change times, Cook Powers or add cycles any time before or after touching START:

- Touch STOP/CLEAR twice.
- Enter your new instructions.



One-Touch Cooking

One-Touch Cooking allows you to pop popcorn, heat a beverage or warm up a dinner plate by touching just one pad. Before using One-Touch Cooking, be sure the time of day is showing on the Display. If the time of day is not on the Display, touch STOP/CLEAR once or twice.

1. Put food in the oven and close the door.
2. Touch the desired One-Touch Cooking item Command Pad:
 - Touch DINNER PLATE to heat a plate of food. Place meat and bulky vegetables to the outside of plate. Cover with wax paper.
 - Touch POPCORN to pop popcorn. This setting works well with most 3.5 oz bags of microwave popcorn. Cooking performance may vary with brand. Try several brands to decide which gives best popping results. For best results, use fresh bags of popcorn. Do not try to repop unpopped kernels. Do not reuse popcorn bags.
NOTE: One-Touch Cooking is designed for commercially bagged microwave popcorn. If you are using a microwave popcorn popper, follow instructions with the popper for cooking time.
 - Touch BEVERAGE to heat a half-cup of a cooled beverage to a better drinking temperature. Stir after heating.
3. The Display will count down the cooking time and the COOK Indicator will appear on the Display. When the cooking time ends, a long tone will sound. The Display will then show the time of day.

NOTE: BEVERAGE is programmed to reheat a mug ½-full of beverage with One-Touch. To reheat a full cup, touch BEVERAGE twice within one second. You cannot cook double quantities with POPCORN or DINNER PLATE.

ADD MINUTE

Using ADD MINUTE

ADD MINUTE allows you to add an extra minute, at 100% Cook Power, to your cooking cycle. You can also use it to extend cooking time in multiples of one minute.

1. Make sure food is in the oven.
2. Touch ADD MINUTE.
3. To extend cooking time in multiples of one minute, touch ADD MINUTE repeatedly during cooking. When the cooking time ends, a long tone will sound. The Display will then show the time of day.

NOTE: ADD MINUTE can only be entered after closing the door, after touching STOP/CLEAR, during cooking or within one minute after cooking with another function.

ADD MINUTE cannot be used:

- with One-Touch Cooking, AUTO COOK or AUTO DEFROST.
- to start the oven if any program is on the Display.



Using PAUSE

PAUSE allows you to stop the oven between cooking cycles to stir, turn food over or add ingredients during the cooking process.

1. Put food in the oven and close the door.
2. Touch in instructions for the first cooking cycle. (See pages 12-13.) The POWER LEVEL Command pad must be touched between cycles.
 - Touch POWER LEVEL twice for full (100%) Cook Power.
 - If cooking at a lower Cook Power, touch POWER LEVEL, then a Number Pad for the Cook Power you want in the first cycle.
3. Touch TIMER/PAUSE.
4. Touch in instructions for the second cooking cycle. (See pages 12-13.)
5. Touch START. The Display will count down the time in the first cycle.
6. When the first cycle is over, 4 tones will sound and "PAUSE" will show in the Display. Open the door and stir the food. Close the door and touch START for the second cooking cycle. When the cooking time ends, a long tone will sound. The Display will then show the time of day.

Using AUTO START

AUTO START lets you program your oven to begin cooking automatically at a designated time of day. You can touch in up to 99 minutes, 99 seconds of delay.

1. Put in food and close the door.
2. Make sure the clock is set to the correct time of day.
3. Touch Number Pads to enter the desired start time. This example shows a 4:30 start time.
4. Touch AUTO START/CLOCK.
5. Touch Number Pads to enter the amount of cooking time you want.
6. Touch POWER LEVEL twice to cook at full (100%) power or touch POWER LEVEL once followed by a Number Pad for the Cook Power you want.
7. Touch START. The oven will start at the time you set and the Display will count down the cooking time you have selected.

8. When the cooking time ends, a long tone will sound. The Display will then show the time of day.

NOTE: If you hear the fan start when you touch START, you have not set the oven properly. Touch STOP/CLEAR twice and start over.

AUTO START cannot be used with ADD MINUTE, AUTO DEFROST or One-Touch Cooking.

4 3 0

AUTO START
CLOCK

2 0 0 0

POWER LEVEL

START

⚠ WARNING

To avoid sickness and food waste when using Auto Start:

- Do not use foods that will spoil while waiting for cooking to start, such as dishes with milk or eggs, cream soups, and cooked meats or fish. Any food that has to wait for cooking to start should be very cold or frozen before it is put in the oven. **MOST UNFROZEN FOODS SHOULD NEVER STAND MORE THAN TWO HOURS BEFORE COOKING STARTS.**
- Do not use foods containing baking powder or yeast when using Auto Start. They will not rise properly.
- Do not allow food to remain in oven for more than two hours after end of cooking cycle.

Installation Instructions

Before you begin operating the oven, carefully read the following instructions.

Installing your microwave oven

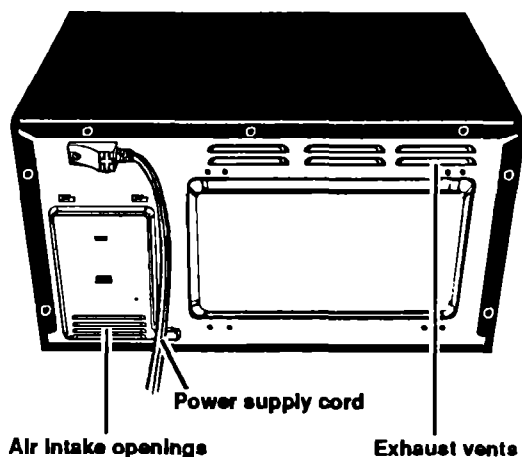
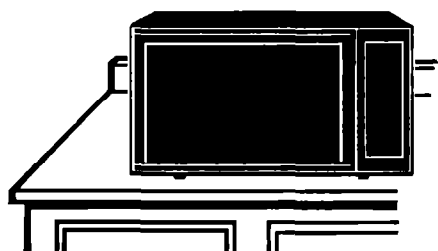
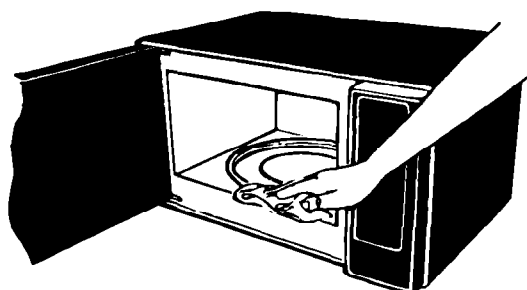

1. Empty the microwave oven and clean inside it with a soft, damp cloth. Check for damage such as misaligned door, damage around the door or dents inside the oven or on the exterior. If there is any damage, do not operate the unit until it has been checked by an authorized WhirlpoolSM service technician and any repairs made.

2. Put the oven on a cart, counter, table or shelf that is strong enough to hold the oven and the food and utensils you put in it. **(The control side of the unit is the heavy side. Use care when handling.)** The weight of the oven is approximately 35 lbs (15.75 kg).

3. Do not block the rear air intake openings or exhaust vents. Allow a few inches of air circulation at back of oven where intake openings and exhaust vents are located. Blocking the air intake openings and exhaust vents can cause damage to the oven and poor cooking results. Make sure the microwave oven legs are in place to ensure proper airflow.

CAUTION

Product Damage Hazard

Do not install the oven next to or over a heat source (for example, a cooktop or range) or in any area where excessive heat and steam are generated. This could damage the outside of the cabinet.

Built-in kit

You can build-in your oven by using one of the following kits:

-24" for MT6900XW (Kit No. 4313648)

-27" for MT6900XW (Kit No. 4313601)

-24" for MT6901XW (Kit No. 4313649)

-27" for MT6901XW (Kit No. 4313602)

These kits are available from your Whirlpool Dealer. If your dealer does not stock the kit it can be ordered by writing to:

Whirlpool Corporation
Attention: Customer Service Dept.
1900 Whirlpool Drive
LaPorte, IN 46350

4. Electrical requirements

Observe all governing codes and ordinances. A 120 Volt, 60 Hz, AC only, 15 or 20 amp fused electrical supply is required. (Time-delay fuse is

recommended.) It is recommended that a separate circuit serving only this appliance be provided.

5. GROUNDING INSTRUCTIONS

⚠ WARNING

Electrical Shock Hazard

Improper use of the grounding plug can result in a risk of electrical shock. DO NOT, UNDER ANY CIRCUMSTANCES, REMOVE THE POWER SUPPLY CORD GROUNDING PRONG.

6. For your personal safety, this appliance must be grounded. In the event of an electrical short circuit, grounding reduces the risk of electrical shock by providing an escape wire for the electric current. This appliance is equipped with a polarized 3-prong grounding plug. It must be plugged into a correctly polarized mating 3-prong grounding type wall receptacle, properly installed and grounded in accordance with the National Electrical Code and local codes and ordinances. If a mating wall receptacle is not available or if you are not sure if the wall receptacle is properly grounded and polarized, have it checked by a qualified electrician.

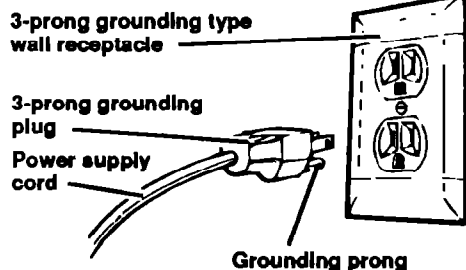

It is the personal responsibility and obligation of the customer to have a properly grounded and correctly polarized 3-prong wall receptacle installed by a qualified electrician.

Consult a qualified electrician if the grounding instructions are not completely understood, or if doubt exists as to whether the appliance is properly grounded.

It is not recommended to use an extension cord with your microwave oven, but if you find it necessary to do so temporarily (until a properly grounded and polarized 3-prong receptacle is installed), use only a heavy duty UL listed 3-wire grounding type extension cord containing three 16-gauge (minimum) copper wires. It must not be longer than 10 feet (cords longer than 10 feet may affect the cooking performance of your microwave oven). The plug on the extension cord must fit into a 3-prong grounding type wall receptacle (as shown on this page) and the receptacle end of the extension cord must accept the 3-prong grounding plug of the microwave oven.

7.  To test the oven, plug it into the proper electrical outlet. Put about one cup (250mL) of cold water in a glass container in the oven. Close the door. Make sure it latches. Follow the directions on page 12 to set the oven to cook for 2 minutes. When the time is up, the water should be heated.

8. **This microwave oven is designed for use in the household only and must not be used for commercial purposes.**

Do not remove the door, control panel or cabinet at any time. The unit is equipped with high voltage and should be serviced by an authorized WhirlpoolSM service technician.

- SAVE THESE INSTRUCTIONS -

Caring For Your Microwave Oven

Cleaning the microwave oven

Wipe often with warm, sudsy water and a soft cloth or sponge. The glass turntable may be removed for cleaning; however, this oven is designed to operate with the turntable in place. **Do not** operate the microwave oven when turntable is removed for cleaning. See page 30 for further information about the turntable.

For stubborn soil, boil a cup of water in the oven for 2 or 3 minutes. Steam will soften the soil.

Be sure to keep the areas clean where the door and oven frame touch when closed. Use only mild, nonabrasive soaps or detergents applied with a sponge or soft cloth when cleaning surfaces. Rinse well.

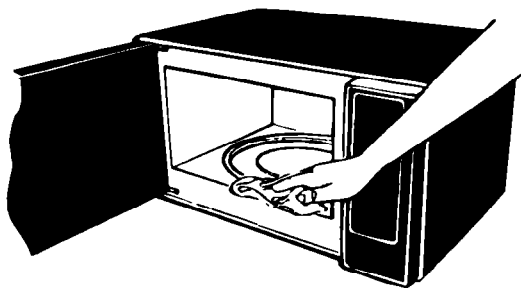
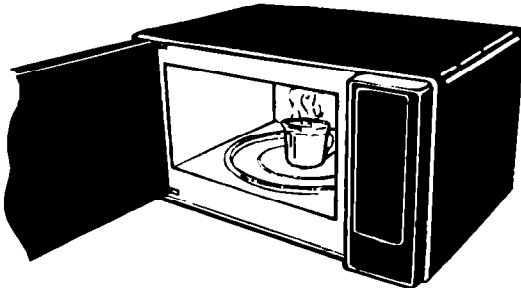
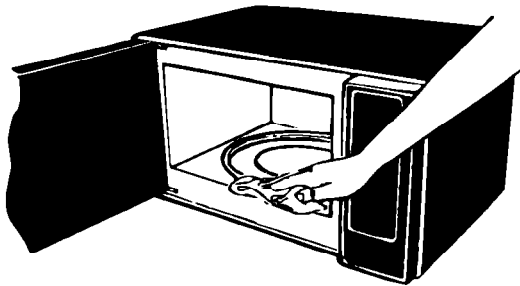

CAUTION

Product Damage Hazard

Abrasive cleansers, steel-wool pads, gritty wash cloths, etc., can damage the control panel, and the interior and exterior oven surfaces. Use a soft cloth or a sponge with a mild detergent or spray glass cleaner. Apply spray glass cleaner to cloth or sponge; do not spray directly on oven.

To clean turntable and turntable support, wash in mild, sudsy water; for heavily soiled areas use a mild cleanser and scouring sponge. The turntable and turntable support are dishwasher-safe.

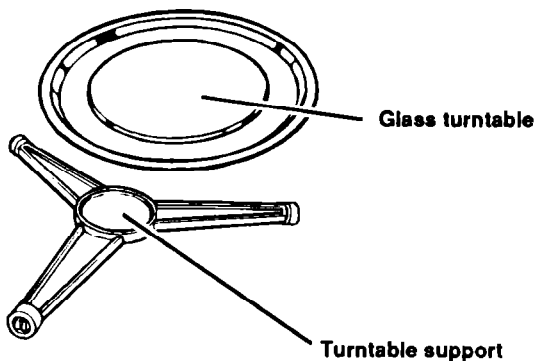

How Your Microwave Oven Works

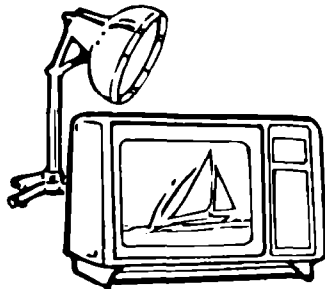

Microwave ovens are safe. Microwave energy is not hot. It causes food to make its own heat, and it's this heat that cooks the food.

Microwaves are like TV waves or light waves. You cannot see them, but you can see what they do.

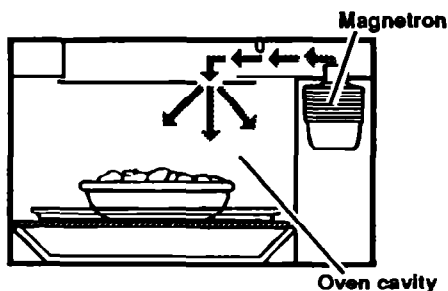

A magnetron in the microwave oven produces microwaves. The microwaves move into the oven where they contact food as it turns on the glass turntable.

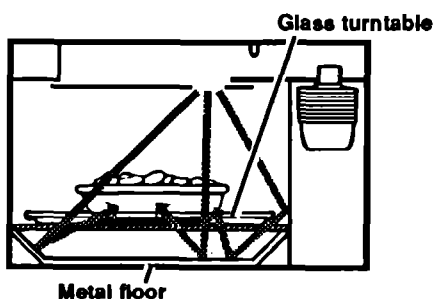

The glass turntable of your microwave oven lets microwaves pass through. Then they bounce off a metal floor, back through the glass turntable and are absorbed by the food.

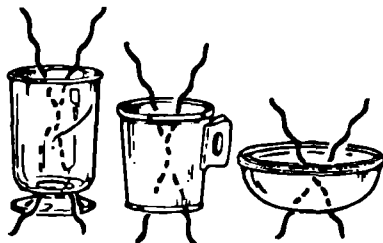

Microwaves pass through most glass, paper and plastics without heating them so food absorbs the energy. Microwaves bounce off metal pans so food does not absorb the energy.

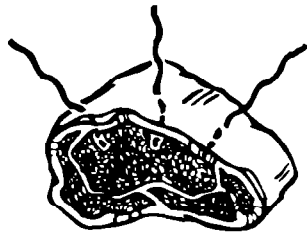

Microwaves may not reach the center of a roast. The heat around the outside is what cooks the roast all the way through. This is one of the reasons for letting some foods (roasts, baked potatoes) stand for a while after cooking, or for stirring some foods during the cooking time.

The microwaves disturb water molecules in the food. As the molecules bounce around bumping into each other, heat is made, like rubbing your hands together. This is the heat that does the cooking.

Operating Safety Precautions

⚠ WARNING

To reduce the risk of burns, fire, electrical shock, injury to persons, or damage when using the microwave oven, follow the precautions on pages 28-31.



Never cook or reheat a whole egg. Steam build-up in whole eggs may cause them to burst and burn you, and possibly damage the oven. Slice hard-boiled eggs before heating. In rare instances, poached eggs have been known to explode. Cover poached eggs and allow a standing time of one minute before cutting into them.



Stir before heating

Liquids heated in certain containers (especially cylindrical-shaped containers) may become overheated. The liquid may splash out with a loud noise during or after heating or when adding ingredients (coffee, etc.) resulting in harm to the oven and possible personal injury. For best results stir any liquid several times before heating or reheating.

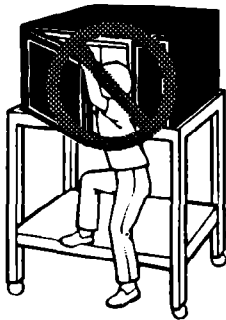

Never lean on the door or allow a child to swing on it when the door is open. Injury could result.

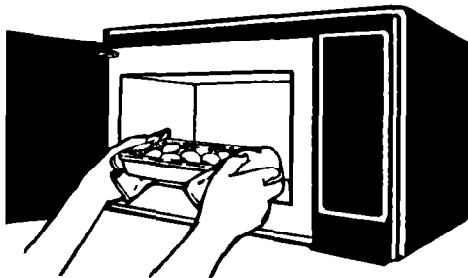

Use hot pads. Microwave energy does not heat containers, but the hot food does.

Do not do canning of foods in the oven. Closed glass jars may explode resulting in damage to the oven or possible personal injury.

Do not use the oven to sterilize objects (baby bottles, etc.). It is difficult to maintain the high temperature required for safe sterilization.

Do not deep fry in the oven. Microwavable utensils are not suitable and it is difficult to maintain appropriate deep frying temperatures.

Do not use the oven for storage. Do not leave paper products, books or cooking utensils in the oven when not in use. Fire may result if someone accidentally starts the oven.

Do not let food or container touch the top or sides of the oven.

Do not heat, store or use flammable materials in or near the oven. Fumes can create a fire hazard or explosion.

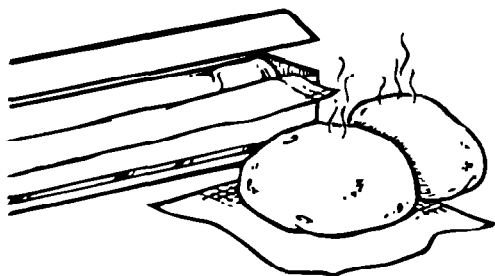
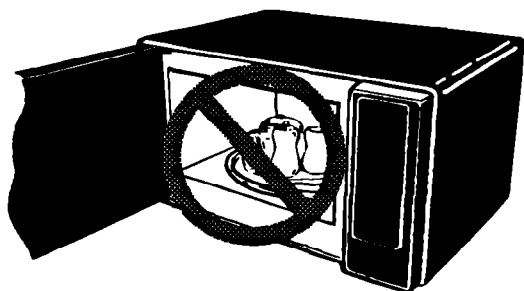

Do not overcook potatoes. Fire could result. At the end of the recommended cooking time potatoes should be slightly firm because they will continue cooking during standing time. After microwaving, wrap potatoes in foil and set aside for 5 minutes. They will finish cooking while standing.

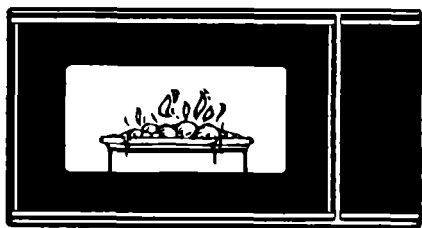

If a fire should start in the oven cavity:

- **Do not open the oven door.**
- **Touch STOP/CLEAR to turn oven off.**
- **Unplug the oven or turn off the power at the main power supply.**

**Operating Safety Precautions
Continued**

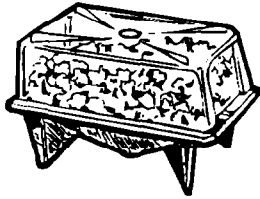

Do not pop popcorn, except in a microwave approved popcorn popper or commercial package designed especially for microwave ovens.

Never try to pop popcorn in a paper bag not designed for microwave oven use. Overcooking may result in smoke and fire. For microwaving bags of popcorn, see page 20 for instructions on using the Popcorn feature.

Do not repop unpopped kernels.

Do not reuse popcorn bags.

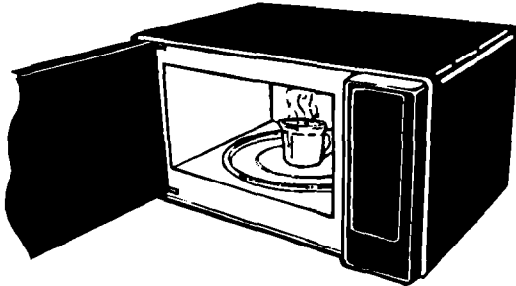

Starting a microwave oven when it is empty is not recommended. Product life may be shortened.

If you practice programming the oven, put a container of water in the oven.

It is normal for the oven door to look wavy after the oven has been running for a while.

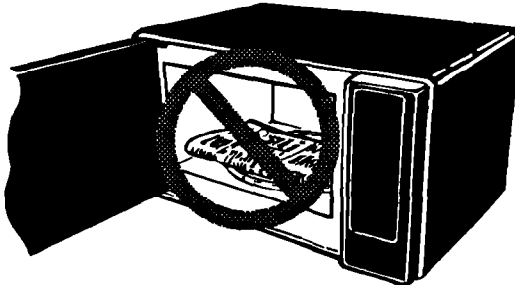

Do not use newspaper or other printed paper in the oven. Fire could result.

Do not dry flowers, fruit, herbs, wood, paper, gourds or clothes in the oven. Fire could result.

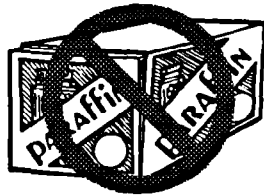

Do not try to melt paraffin wax in the oven. Paraffin wax will not melt in a microwave oven because it allows microwaves to pass through it.

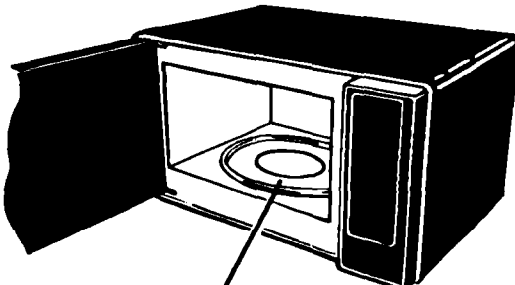

Glass turntable

Do not operate the microwave oven unless the glass turntable is securely in place and can rotate freely. The turntable can rotate in either direction.

Make sure the glass turntable is correct-side up in oven. Carefully place cookware on glass turntable to avoid possible breakage.

Handle glass turntable with care when removing from oven to avoid possible breakage. If glass turntable cracks or breaks, contact your Whirlpool dealer for a replacement.

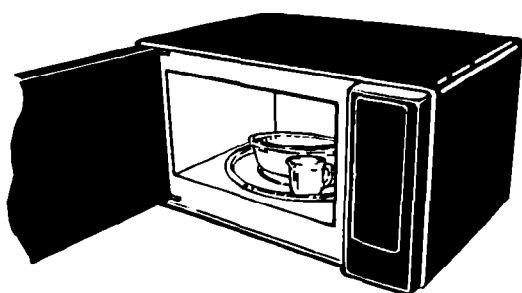
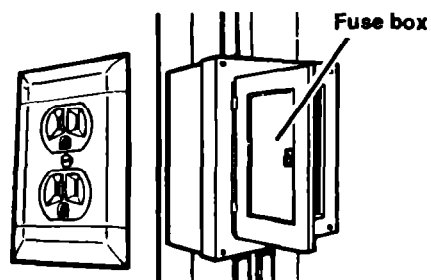

General information

If your electric power line or outlet voltage is less than the normal 120 volts, cooking times may be longer.

To test a dish for safe use, put it into the oven with a cup of water beside it. Cook on 100% Cook Power for one minute. If the dish gets hot and water stays cool, do not use it. Some dishes (melamine, Centura® etc.) absorb microwave energy, becoming too hot to handle and slowing cooking times.

⚠ CAUTION

Product Damage Hazard

Remove wire twist-ties from paper or plastic bags before placing bag in oven. Cooking in metal containers not designed for microwave use can damage the oven, as can containers with hidden metal (twist-ties, foil lining, staples, metallic glaze or trim).

Cooking Guide

Reheating chart

ITEM	STARTING TEMP	TIME/POWER	PROCEDURE
Meat (Chicken pieces, chops, hamburgers, meat loaf slices) 1 serving 2 servings	Refrigerated Refrigerated	1-2 min at 70% 2 1/2-4 1/2 min at 70%	Cover loosely.
Meat Slices (Beef, ham, pork, turkey) 1 or more servings	Room temp Refrigerated	45 sec-1 min per serving at 50% 1-3 min per serving at 50%	Cover with gravy or wax paper. Check after 30 sec per serving.
Stirrable Casseroles and Main Dishes 1 serving 2 servings 4-6 servings	Refrigerated Refrigerated Refrigerated	2-4 min at 100% 4-6 min at 100% 6-8 min at 100%	Cover. Stir after half the time.
Nonstirrable Casseroles and Main Dishes 1 serving 2 servings 4-6 servings	Refrigerated Refrigerated Refrigerated	5-8 min at 50% 9-12 min at 50% 13-16 min at 50%	Cover with wax paper.
Soup, Cream 1 cup 1 can (10 3/4 oz)	Refrigerated Room temp	3-4 1/2 min at 50% 5-7 min at 50%	Cover. Stir after half the time.
Soup, Clear 1 cup 1 can (10 3/4 oz)	Refrigerated Room temp	2 1/2-3 1/2 min at 100% 4-5 1/2 min at 100%	Cover. Stir after half the time.
Pizza 1 slice 1 slice 2 slices 2 slices	Room temp Refrigerated Room temp Refrigerated	15-25 sec at 100% 30-40 sec at 100% 30-40 sec at 100% 45-55 sec at 100%	Place on paper towel.
Vegetables 1 serving 2 servings	Refrigerated Refrigerated	3/4-1 1/2 min at 100% 1 1/2-2 1/2 min at 100%	Cover. Stir after half the time.
Baked Potato 1 2	Refrigerated Refrigerated	1-2 min at 100% 2-3 min at 100%	Cut potato lengthwise and then several times crosswise. Cover with wax paper.
Breads (Dinner or breakfast roll) 1 roll 2 rolls 4 rolls	Room temp Room temp Room temp	8-12 sec at 100% 11-15 sec at 100% 18-22 sec at 100%	Wrap single roll, bagel or muffin in paper towel. To reheat several, line plate with paper towel. Cover with another paper towel.
Pie Whole 1 slice	Refrigerated Refrigerated	5-7 min at 70% 30 sec at 100%	

Microwave cooking chart

MEATS, POULTRY, FISH, SEAFOOD Allow standing time after cooking.			REHEATING Food should be very hot (165°F). Stir before serving, if possible.		
FOOD	POWER LEVEL	TIME	FOOD	POWER LEVEL	TIME
Bacon	100%	3/4-1 1/4 min/slice	Meat slices	50%	1-3 min/serving
Ground beef for casseroles (1 lb)	100%	4-6 min	Non-stirrable casseroles (1 serving) (2 servings)	50%	5-8 min 9-12 min
Hamburger patties (2)	100%	1st side 2 min 2nd side 1 1/2 to 2 1/2 min	Pie (1 slice)	100%	20-40 seconds
Hamburger patties (4)	100%	1st side 2 1/2 min 2nd side 2-3 min	Soup (1 serving) (2 servings)	100%	2 1/2-3 1/2 min 4 1/2-5 1/2 min
Meat loaf (1 1/2 lbs)	100%	13-19 min	Vegetables (1 serving) (2 servings)	100%	3/4-1 1/2 min 1 1/2-2 1/2 min
Chicken pieces	100%	6-9 min/lb	OTHER		
Internal temperature should be 185°F after standing.			FOOD	POWER LEVEL	TIME
Turkey breast	100% then 70%	5 min 8-12 min/lb	Applesauce (4 servings)	100%	7-10 min
Internal temperature should be 185°F after standing.			Baked apples (4)	100%	4-6 min
Fish fillets (1 lb)	100%	5-6 min	Chocolate (melt 1 square)	50%	1-2 min
Scallops and shrimp (1 lb)	100%	3 1/2-5 1/2 min	Eggs, scrambled (2) (4)	100%	1 1/4-1 3/4 min 2-3 min
VEGETABLES Cook on 100% power level.			Hot cereals (1 serving) (4 servings)	100%	1 1/2-5 min 4 1/2-7 min
FOOD		TIME	Nachos (large plate)	50%	1 1/2-2 1/2 min
Beans, green or yellow (1 lb)		6-12 min	Water for beverage (1 cup) (2 cups)	100%	2 1/2-4 min 4 1/2-6 min
Broccoli (1 lb)		6-10 min			
Carrots (1 lb)		8-12 min			
Cauliflower (medium head)		6-9 min			
Corn on the cob (2) (4)		4-9 min 6-16 min			
Potatoes, baked (4 medium)		13-19 min			
Squash, summer (1 lb)		3-8 min			

Questions And Answers

QUESTIONS	ANSWERS
Can I operate my microwave oven without the turntable or turn the turntable over to accommodate a large dish?	No. If you remove or turn over the turntable, you will get poor cooking results. Dishes used in your oven must fit on the turntable.
Can I use a rack in my microwave oven so that I may reheat or cook on two levels at a time?	No. When you place a rack on the turntable, cooking results will be uneven and unpredictable.
Can I use either metal or aluminum pans in my microwave oven?	Useable metal includes aluminum foil for shielding, (use small, flat pieces), small skewers and shallow foil trays (if tray is 3/4 inch deep and filled with food to absorb microwave energy). Never allow metal to touch walls or door.
Is it normal for the turntable to turn in either direction?	Yes. The turntable rotates clockwise or counter-clockwise, depending on the rotation of the motor when the cooking cycle begins.
Sometimes the door of my microwave oven appears wavy. Is this normal?	This appearance is normal and does not affect the operation of your oven.
What are the humming noises that I hear when my microwave oven is operating?	You hear the sound of the magnetron tube cycling on and off when cooking at less than 100% power.
Why does the dish become hot when I microwave food in it? I thought that this should not happen.	As the food becomes hot it will conduct the heat to the dish. Be prepared to use hot pads to remove food after cooking.
What does "standing time" mean?	"Standing time" means that food should be taken out of the oven and covered for additional time after cooking. This process allows the cooking to finish, saves energy and frees the oven for another purpose.
Can I pop popcorn in my microwave oven? How do I get the best results?	Yes. Pop packaged microwave popcorn following manufacturer's guidelines or use the One-Touch Cooking pad. Do not use regular paper bags. Use the "listening test" by stopping the oven as soon as the popping slows to a "pop" every one or two seconds. Do not try to repop unpopped kernels. Use only special microwave poppers being sure to follow manufacturer's directions. Do not pop popcorn in glass utensils.

If You Need Service Or Assistance ...

We suggest you follow these steps:

1. Before calling for assistance ...

Performance problems often result from little things you can find and fix without tools of any kind.

If nothing operates:

- Is the power supply cord plugged into a live circuit with the proper voltage? (See Installation Instructions.)
- Have you checked your home's main fuses or circuit breaker box?
- Have you checked the electric company for a power failure?

If the microwave oven will not run:

- Is the oven being used as a timer?
- Is the door firmly closed and latched?
- Did you touch START?
- Did you follow the directions exactly?
- Did you touch STOP/CLEAR twice to cancel previous programming?

If the microwave cooking times seem too long:

- Is the electric supply to your home or wall outlets low or lower than normal? Your electric company can tell you if the line voltage is low. Your electrician or service technician can tell you if the outlet voltage is low.
- Is the Cook Power at the recommended setting?
- Are you allowing for more time when cooking more food at one time?

If the Display shows a time counting down but the oven is not cooking:

- Is the oven door closed completely?
- Have you set the controls as a kitchen timer?

If you do not hear the Programming Tone:

- Is the command correct?

If the fan seems to be running slower than usual:

- Has the oven been stored in a cold area? The fan will run slower until the oven warms up to normal room temperature.

If there has been a power interruption, the Display will flash 88:88. Reset the clock. (See page 11.)

2. If you need assistance*...

Call Whirlpool Consumer Assistance Center telephone number. Dial free from anywhere in the U.S.:

1-800-253-1301

and talk with one of our trained consultants. The consultant can instruct you in how to obtain

satisfactory operation from your appliance or, if service is necessary, recommend a qualified service company in your area.

If you prefer, write to:

Mr. Donald Skinner
Director of Consumer Relations
Whirlpool Corporation
2000 M-63
Benton Harbor, MI 49022

Please include a daytime phone number in your correspondence.

3. If you need service*...

 Whirlpool has a nationwide network of authorized WhirlpoolSM service companies. Whirlpool service technicians are trained to fulfill the product warranty and provide after-warranty service, anywhere in the United States. To locate the authorized Whirlpool service company in your area, call our Consumer Assistance Center telephone number (see Step 2) or look in your telephone directory Yellow Pages under:

APPLIANCES - HOUSEHOLD - MAJOR - SERVICE & REPAIR ELECTRICAL APPLIANCES - MAJOR - REPAIRING & PARTS
OR
WASHING MACHINES, DRYERS & IRONERS - SERVICING
WHIRLPOOL APPLIANCES AUTHORIZED WHIRLPOOL SERVICE
SERVICE COMPANIES
XYZ SERVICE CO
123 Maple.....900-9090

4. If you are not satisfied with how the problem was solved*...

- Contact the Major Appliance Consumer Action Panel (MACAP). MACAP is a group of independent consumer experts that voices consumer views at the highest levels of the major appliance industry.
- Contact MACAP only when the dealer, authorized servicer or Whirlpool have failed to resolve your problem.

Major Appliance Consumer Action Panel
20 North Wacker Drive
Chicago, IL 60606

- MACAP will in turn inform us of your action.

*When requesting assistance, please provide: model number, serial number, date of purchase, and a complete description of the problem. This information is needed in order to better respond to your request.

WHIRLPOOL® Microwave Oven Warranty

MW007

LENGTH OF WARRANTY	WHIRLPOOL WILL PAY FOR
FULL ONE-YEAR WARRANTY From Date of Purchase	FSP® replacement parts and repair labor to correct defects in materials or workmanship. Service must be provided by an authorized Whirlpool SM service company.
LIMITED FOUR-YEAR WARRANTY Second Through Fifth Year From Date of Purchase	FSP® replacement magnetron tube on microwave ovens if defective in materials or workmanship.
WHIRLPOOL WILL NOT PAY FOR	
<p>A. Service calls to:</p> <ol style="list-style-type: none"> 1. Correct the installation of the microwave oven. 2. Instruct you how to use the microwave oven. 3. Replace house fuses or correct house wiring. 4. Replace owner accessible light bulbs. <p>B. Repairs when microwave oven is used in other than normal, single-family household use.</p> <p>C. Pickup and delivery. This product is designed to be repaired in the home.</p> <p>D. Damage to microwave oven caused by accident, misuse, fire, flood, acts of God or use of products not approved by Whirlpool.</p> <p>E. Any labor costs during limited warranty.</p> <p>F. Repairs to parts or systems caused by unauthorized modifications made to the appliance.</p>	

WHIRLPOOL CORPORATION SHALL NOT BE LIABLE FOR INCIDENTAL OR CONSEQUENTIAL DAMAGES. Some states do not allow the exclusion or limitation of incidental or consequential damages, so this limitation or exclusion may not apply to you. This warranty gives you specific legal rights, and you may also have other rights which vary from state to state.

Outside the United States, a different warranty may apply. For details, please contact your authorized Whirlpool distributor or military exchange.

If you need service, first see the "Service and Assistance" section of this book. After checking "Service and Assistance," additional help can be found by calling our Consumer Assistance Center telephone number, 1-800-253-1301, from anywhere in the U.S.

® Registered Trademark / SM Service Mark of Whirlpool Corporation