



---

# MICROWAVE HOOD COMBINATION

## Use & Care Guide

For questions about features, operation/performance parts, accessories or service, call: **1-800-253-1301**.

or visit our website at...  
[www.whirlpool.com](http://www.whirlpool.com)

---

Table of Contents .....2

---

**Model GH9185XL**

---

# TABLE OF CONTENTS

<b>MICROWAVE OVEN SAFETY</b> .....	<b>3</b>
Electrical Requirements .....	5
<b>PARTS AND FEATURES</b> .....	<b>5</b>
Turntable .....	5
Designed Cooking Rack .....	6
<b>MICROWAVE OVEN CONTROL</b> .....	<b>6</b>
Display .....	6
Progress Bar.....	7
Number Codes.....	7
JET START™ Feature .....	7
JET COOK™ Feature.....	7
Off/Cancel .....	7
Clock .....	7
Tones.....	7
Timer.....	7
Control Lock.....	8
Vent Fan .....	8
Cooktop Light.....	8
Demo Learning Mode .....	8
<b>MICROWAVE OVEN USE</b> .....	<b>8</b>
Food Characteristics .....	9
Cooking Guidelines .....	9
Cookware and Dinnerware .....	9
Aluminum Foil and Metal .....	10
Inverter Microwave System .....	10
Cooking Power.....	10
Cooking .....	11
6th Sense™ System Cooking.....	11
Pre-Set Cooking.....	12
Beverage .....	12
Cooking in Stages.....	12
Reheating .....	13
Defrosting .....	13
Soften .....	14
Melt.....	14
Kids Menu .....	15
Simmer Cooking and Steaming.....	15
Warm Hold .....	16
<b>MICROWAVE OVEN CARE</b> .....	<b>16</b>
General Cleaning.....	16
Replacing Filters.....	17
Replacing Cooktop Light .....	17
Replacing Microwave Oven Light .....	18
<b>TROUBLESHOOTING</b> .....	<b>18</b>
<b>ASSISTANCE OR SERVICE</b> .....	<b>19</b>
<b>WARRANTY</b> .....	<b>20</b>



# MICROWAVE OVEN SAFETY

## Your safety and the safety of others are very important.

We have provided many important safety messages in this manual and on your appliance. Always read and obey all safety messages.



This is the safety alert symbol.

This symbol alerts you to potential hazards that can kill or hurt you and others.

All safety messages will follow the safety alert symbol and either the word "DANGER" or "WARNING." These words mean:

**! DANGER**

**You can be killed or seriously injured if you don't immediately follow instructions.**

**! WARNING**

**You can be killed or seriously injured if you don't follow instructions.**

All safety messages will tell you what the potential hazard is, tell you how to reduce the chance of injury, and tell you what can happen if the instructions are not followed.

## IMPORTANT SAFETY INSTRUCTIONS

When using electrical appliances basic safety precautions should be followed, including the following:

**WARNING:** To reduce the risk of burns, electric shock, fire, injury to persons, or exposure to excessive microwave energy:

- Read all instructions before using the microwave oven.
- Read and follow the specific "PRECAUTIONS TO AVOID POSSIBLE EXPOSURE TO EXCESSIVE MICROWAVE ENERGY" found in this section.
- The microwave oven must be grounded. Connect only to properly grounded outlet. See "GROUNDING INSTRUCTIONS" found in this section and in the provided Installation Instructions.
- Install or locate the microwave oven only in accordance with the provided Installation Instructions.
- Some products such as whole eggs in the shell and sealed containers – for example, closed glass jars – may explode and should not be heated in the microwave oven.
- Use the microwave oven only for its intended use as described in this manual. Do not use corrosive chemicals or vapors in the microwave oven. This type of oven is specifically designed to heat, cook, or dry food. It is not designed for industrial or laboratory use.
- As with any appliance, close supervision is necessary when used by children.
- Do not operate the microwave oven if it has a damaged cord or plug, if it is not working properly, or if it has been damaged or dropped.
- The microwave oven should be serviced only by qualified service personnel. Call an authorized service company for examination, repair, or adjustment.
- See door surface cleaning instructions in the "Microwave Oven Care" section.
- To reduce the risk of fire in the oven cavity:
  - Do not overcook food. Carefully attend the microwave oven if paper, plastic, or other combustible materials are placed inside the oven to facilitate cooking.
  - Remove wire twist-ties from paper or plastic bags before placing bags in oven.
  - If materials inside the oven should ignite, keep oven door closed, turn oven off, and disconnect the power cord, or shut off power at the fuse or circuit breaker panel.
  - Do not use the cavity for storage purposes. Do not leave paper products, cooking utensils, or food in the cavity when not in use.

**SAVE THESE INSTRUCTIONS**

## IMPORTANT SAFETY INSTRUCTIONS

- Suitable for use above both gas and electric cooking equipment.
- Intended to be used above ranges with maximum width of 36 inches.
- Clean Ventilating Hoods Frequently - Grease should not be allowed to accumulate on hood or filter.
- Oversized foods or oversized metal utensils should not be inserted in the microwave oven as they may create a fire or risk of electric shock.
- Do not clean with metal scouring pads. Pieces can burn off the pad and touch electrical parts involving a risk of electric shock.
- Do not use paper products when appliance is operated in the "PAN BROWN" mode (on models with this feature).
- Do not store any materials, other than manufacturer's recommended accessories, in this oven when not in use.
- Do not store anything directly on top of the microwave oven when the microwave oven is in operation.
- When flaming foods under the hood, turn the fan on.
- Use care when cleaning the vent-hood filter. Corrosive cleaning agents, such as lye-based oven cleaners, may damage the filter.
- Do not cover or block any openings on the microwave oven.
- Do not store this microwave oven outdoors. Do not use the microwave oven near water - for example, near a kitchen sink, in a wet basement, or near a swimming pool, and the like.
- Do not immerse cord or plug in water.
- Keep cord away from heated surfaces.
- Do not let cord hang over edge of table or counter.
- Do not mount over a sink.
- Do not cover racks or any other part of the oven with metal foil. This will cause overheating of the oven.

## SAVE THESE INSTRUCTIONS

## PRECAUTIONS TO AVOID POSSIBLE EXPOSURE TO EXCESSIVE MICROWAVE ENERGY...

- (a) Do not attempt to operate this oven with the door open since open-door operation can result in harmful exposure to microwave energy. It is important not to defeat or tamper with the safety interlocks.
- (b) Do not place any object between the oven front face and the door or allow soil or cleaner residue to accumulate on sealing surfaces.
- (c) Do not operate the oven if it is damaged. It is particularly important that the oven door close properly and that there is no damage to the:
  - (1) Door (bent),
  - (2) Hinges and latches (broken or loosened),
  - (3) Door seals and sealing surfaces.
- (d) The oven should not be adjusted or repaired by anyone except properly qualified service personnel.

## Electrical Requirements

### **⚠ WARNING**



#### Electrical Shock Hazard

Plug into a grounded 3 prong outlet.

Do not remove ground prong.

Do not use an adapter.

Do not use an extension cord.

Failure to follow these instructions can result in death, fire, or electrical shock.

Observe all governing codes and ordinances. A 120 Volt, 60 Hz, AC only, 15- or 20-amp fused electrical supply is required. (A time-delay fuse or circuit breaker is recommended.) It is recommended that a separate circuit serving only this appliance be provided.

### GROUNDING INSTRUCTIONS

#### ■ For all cord connected appliances:

The microwave oven must be grounded. In the event of an electrical short circuit, grounding reduces the risk of electric shock by providing an escape wire for the electric current. The microwave oven is equipped with a cord having a grounding wire with a grounding plug. The plug must be plugged into an outlet that is properly installed and grounded.

**WARNING:** Improper use of the grounding plug can result in a risk of electric shock. Consult a qualified electrician or serviceman if the grounding instructions are not completely understood, or if doubt exists as to whether the microwave oven is properly grounded.

Do not use an extension cord. If the power supply cord is too short, have a qualified electrician or serviceman install an outlet near the microwave oven.

#### ■ For a permanently connected appliance:

This appliance must be connected to a grounded, metallic, permanent wiring system, or an equipment grounding conductor should be run with the circuit conductors and connected to the equipment grounding terminal or lead on the appliance.

**SAVE THESE INSTRUCTIONS**

## PARTS AND FEATURES

This manual may cover several different models. The model you have purchased may have some or all of the features shown here. The appearance of your particular model may differ slightly from the illustrations in this manual.

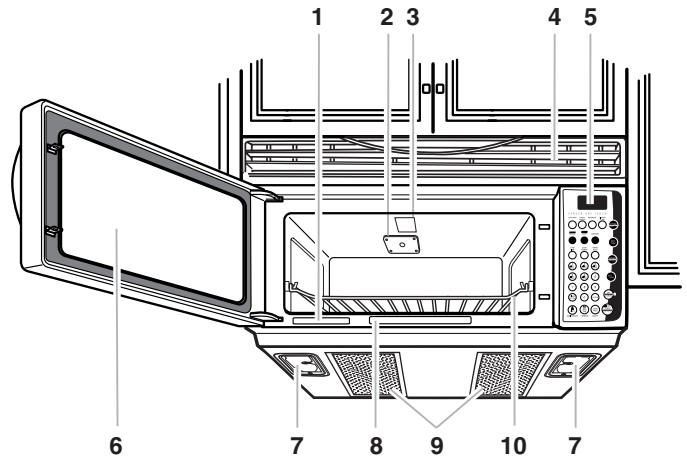

1. Model and Serial Number Plate

2. Microwave Inlet Cover

3. Microwave Light

4. Vent Grille

5. Control Panel

6. Metal Shielded Window

7. Cooktop Light

8. Cooking Guide Label

9. Charcoal and Grease Filters  
(shipped in oven cavity)

10. Cooking Rack

Parts and Features not shown:

Turntable

Tupperware® Microsteamer

### Turntable

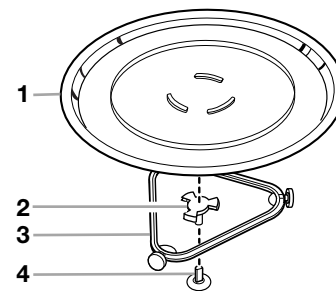

1. Turntable

2. Hub

3. Support

4. Shaft

The turntable rotates in both directions to help cook food more evenly. Do not operate the microwave oven without the turntable in place. See "Assistance or Service" to reorder any of the parts.

## To Install:

1. Remove tape from the hub.
2. Place the support on the oven cavity bottom.
3. Place the turntable on the support.

Fit the raised, curved lines in the center of the turntable bottom between the three spokes of the hub. The rollers on the support should fit inside the turntable bottom ridge.

## To Turn Off:

The turntable can be turned off (except during an auto function). This is helpful when cooking with plates that are larger than the turntable or when cooking with two 10 in. (25 cm) plates that are side-by-side.

1. Touch TURNTABLE ON/OFF.

A turntable-off icon will appear in the display, as well as a prompt to enter the cook time.

2. Touch number pads to enter length of time to cook.

3. Touch JET START.

For optimal results, halfway through cook time turn plate(s) so the food in the front is in the back.

4. Touch OFF/CANCEL (or CANCEL/OFF) or open the door to clear the display and/or stop reminder tones.

Turntable will automatically be turned back on, and the turntable-off icon will disappear.

## Designed Cooking Rack

The cooking rack is ideal for two-level cooking. It provides extra cavity space for cooking two or more containers at the same time. Insert the rack securely into the rack supports on the side walls of the oven. See "Assistance or Service" section to reorder rack.

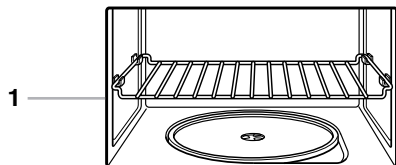

1. Proper use

- Rack will become hot. Always use oven mitts or pot holders when handling.
- Do not allow the rack to touch the inside cavity walls, ceiling or floor.
- Do not use metal cookware, utensils, or a browning dish with the rack.
- Do not let food container on rack touch the top or sides of the oven.
- Do not place popcorn bags on rack.
- The rack is designed specifically for this oven. Do not use it in any other oven.
- Do not cook food directly on the rack. Always use a microwave-safe container.
- Use the rack only when cooking on two levels. Do not store it in the oven. Damage to the oven could result if someone accidentally turns on the oven.

# MICROWAVE OVEN CONTROL

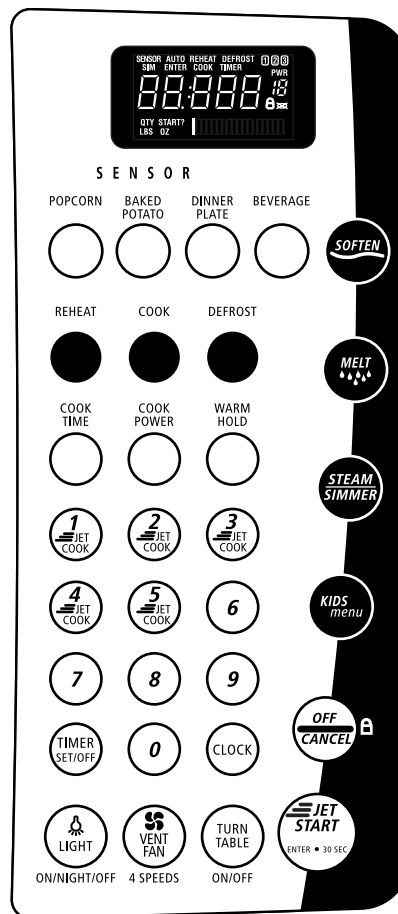

## Display

When power is first supplied to the microwave oven, a ":" will blink on the display. Touch OFF/CANCEL to stop the blinking.

Any other time a ":" blinks on the display, a power failure occurred. Touch OFF/CANCEL and reset the clock if needed.

When the microwave oven is in use, the display shows cooking power, quantities, weights and/or prompts.

If "RETRY" blinks on the display for one second, an invalid value was entered. Retry your entry.

When the microwave oven is not in use, the display shows the time of day or Timer countdown.

---

## Progress Bar



The progress bar is a visual picture of the estimated running time of a cooking cycle. It will appear during all cook cycles except Warm Hold. The lines in each of the segments will light from left to right as the time nears the end. When all fifteen lines (all three segments) are lit, the cooking cycle is completed.

---

## Number Codes

The microwave oven is preset with shortcut number codes. A number code includes one or more of the following: cooking power, cook time and food quantity or weight. See the code charts in the “Cooking” and “Reheating” sections for additional information.

---

## JET START™ Feature

The JET START™ control will start any function. If not touched within 5 seconds after touching a pad, “START?” will appear on the display as a reminder. If not touched within 5 minutes after touching a pad, the display will return to the time of day mode and the programmed function will be canceled.

If cooking is interrupted, touching the JET START™ control will resume the preset cycle.

The JET START™ control, touched by itself, will automatically start the microwave oven for a 30 second cook time at 100% cooking power.

The JET START™ control, touched while the microwave oven is operating in any cook function, will add 30 seconds of cook time at the cook power currently in use. Each touch of the JET START™ console pad will add 30 additional seconds of cook time.

---

## JET COOK™ Feature

The five JET COOK™ controls share function with the numerical pads 1-5. When one of the 5 JET COOK™ controls is touched (while no function is operating), the oven will begin cooking at high power for 1-5 minutes, depending on which pad is touched. After cooking begins, the JET COOK™ controls return to their normal numerical pad function.

---

## Off/Cancel

The OFF/CANCEL pad stops most functions except for the Timer, Control Lock and Demo Learning Mode.

The microwave oven will also turn off when the door is opened. Close the door and touch JET START to resume the cycle.

---

## Clock

This is a 12-hour clock and does not show a.m. or p.m.

### To Set:

Before setting, make sure the microwave oven and Timer are off.

1. Touch CLOCK.
2. Touch the number pads to set the time of day.
3. Touch CLOCK or JET START.

### To Remove:

1. Touch CLOCK.
2. Touch 0.
3. Touch CLOCK.

The time will disappear and “:” will appear on the display.

---

## Tones

Tones are audible signals, indicating the following:

### One tone

- Valid pad touch (short tone)
- End of Timer countdown (long tone)

### Two tones

- Reminder, repeat each minute after the end-of-cycle tones
- Function has been entered or exited

### Three tones

- Invalid pad touch

### Four tones

- End-of-cycle

### All Tones

All of the preceding tones are preset on. All except the end of Timer countdown can be turned off.

**To Turn Off/On:** Touch and hold the number pad [2] for five seconds until two tones sound. Repeat to turn tones back on.

### Valid Pad Touch Tones

The valid pad touch tones are preset on, but can be turned off.

**To Turn Off/On:** Touch and hold the number pad [1] for five seconds or until two tones sound. Repeat to turn tones back on.

---

## Timer

The Timer can be set in minutes and seconds, up to 99 minutes 99 seconds and counts down the set time. The Timer does not start or stop the microwave oven.

When the Timer is in use, the microwave oven can also operate. To see the time countdown for five seconds when the microwave oven is in use, touch TIMER SET/OFF.

## To Set:

1. Touch TIMER SET/OFF.

If no action is taken after one minute, the display will return to the time of day mode.

2. Touch the number pads to set the length of time.
3. Touch TIMER SET/OFF or JET START.

If not touched within five seconds, "START?" will appear on the display. If not touched within one minute, the display will return to the time of day mode and the programmed function will be canceled.

When the set time ends, "END" will appear on the display and one tone will sound.

If timer is active in the display, touch TIMER SET/OFF to cancel timer. If timer is not active in the display, touch TIMER SET/OFF to make timer active in the display, then touch TIMER SET/OFF again or OFF/CANCEL to cancel timer.

Remember, touching OFF/CANCEL while a cook function is active in the display will cancel the cook function, not the timer.

The time can be reset during the countdown by repeating the above steps.

---

## Control Lock

The Control Lock shuts down the control panel pads to prevent unintended use of the microwave oven.

When the control is locked, only the VENT FAN 4 SPEEDS and LIGHT ON/NIGHT/OFF pads will function. If any other pad is touched, "LOCK" will appear in the display and 3 short tones will sound.

The Control Lock is preset unlocked, but can be locked.

**To Lock/Unlock Control:** Before locking, make sure the microwave oven and Timer are off. Touch and hold OFF/CANCEL for five seconds until two tones sound and a picture of a lock appears on the display. Repeat to unlock and remove the lock picture from display.

---

## Vent Fan

The vent fan has four speeds ranging from 4 (fastest) to 1 (slowest). 0 is off.

To protect the microwave oven, if the temperature from the range or cooktop below the microwave oven gets too hot, the vent fan will automatically turn on at speed 4. It may stay on for up to one hour to cool the microwave oven. When this occurs, the VENT FAN 4 SPEEDS pad will not function.

**To Turn Vent Fan On/Off:** Repeatedly touch the VENT FAN 4 SPEEDS pad to cycle through the four speeds 4, 3, 2 and 1 and off, 0. "FAN" and the selected number will appear on the display for two seconds.

---

## Cooktop Light

The cooktop light has three options: on, night and off.

**To Turn On/Night/Off:** Repeatedly touch LIGHT ON/NIGHT/OFF to cycle through options.

---

## Demo Learning Mode

The demo learning mode is ideal for learning how to use the microwave oven. When set, functions can be entered without actually turning on the magnetron. The microwave oven light will come on, the fan will run and, if on, the turntable will rotate.

Before setting, make sure the microwave oven and Timer are off.

**To Turn On/Off:** Touch and hold TIMER OFF for five seconds until two tones sound and "d" appears on the display. Repeat to turn off and remove "d" from the display.

---

# MICROWAVE OVEN USE

A magnetron in the oven produces microwaves which reflect off the metal floor, walls and ceiling and pass through the turntable and appropriate cookware to the food. Microwaves are attracted to and absorbed by fat, sugar and water molecules in the food, causing them to move, producing friction and heat which cooks the food.

- Never lean on or allow children to swing on the oven door.
- Do not operate microwave oven when it is empty.
- Heated liquids can splash out during and after heating. Use of a wooden stir stick placed in the cup or bowl during heating may help to avoid this.
- The turntable must be in place and correct side up when oven is in use. Do not use if turntable is chipped or broken. See "Assistance or Service" section to reorder.
- Baby bottles and baby food jars should not be heated in the oven.
- Clothes, flowers, fruit, herbs, wood, gourds, paper, including brown paper bags and newspaper should not be dried in the oven.
- Do not use the microwave oven for canning, sterilizing or deep frying. The oven cannot maintain appropriate temperatures.
- Paraffin wax will not melt in the oven because it does not absorb microwaves.
- Use oven mitts or pot holders when removing containers from oven.
- Do not overcook potatoes. At the end of the recommended cook time, potatoes should be slightly firm. Let potatoes stand for five minutes. They will finish cooking while standing.
- Do not cook or reheat whole eggs or eggs inside the shell. Steam buildup in whole eggs may cause them to burst. Cover poached eggs and allow a standing time.



---

## Food Characteristics

When microwave cooking, the amount, size and shape, starting temperature, composition and density of the food affect cooking results.

### Amount of Food

The more food heated at once the longer the cook time. Check for doneness and add small increments of time if necessary.

### Size and Shape

Smaller pieces of food will cook more quickly than larger pieces and uniformly shaped foods cook more evenly than irregularly shaped food.

### Starting Temperature

Room temperature foods will heat faster than refrigerated foods and refrigerated foods will heat faster than frozen foods.

### Composition and Density

Foods high in fat and sugar will reach a higher temperature and heat faster than other foods. Heavy, dense foods, such as meat and potatoes, require a longer cook time than the same size of a light, porous food, such as cake.

---

## Cooking Guidelines

### Covering

Covering food helps retain moisture, shorten cook time and reduce spattering. Use the lid supplied with cookware. If lid is not available, wax paper, paper towels or plastic wrap approved for microwaves may be used. Plastic wrap should be turned back at one corner to provide an opening to vent steam.

### Stirring and Turning

Stirring and turning redistributes heat evenly to avoid overcooking the outer edges of food. Stir from outside to center. If possible, turn food over from bottom to top.

### Arranging

If heating irregularly shaped or different sized foods, the thinner parts and smaller sizes should be arranged toward the center. If cooking several items of the same size and shape, place them in a ring pattern, leaving the center of the ring empty.

### Piercing

Before heating, use a fork or small knife to pierce or prick foods that have a skin or membrane, such as potatoes, egg yolks, chicken livers, hot dogs, and sausage. Prick in several places to allow steam to vent.

### Shielding

Use small, flat pieces of aluminum foil to shield the thin pieces of irregularly shaped foods, bones and foods such as chicken wings, leg tips and fish tail. See "Aluminum Foil and Metal" first.

### Standing Time

Food will continue to cook by the natural conduction of heat even after the microwave cycle ends. The length of standing time depends on the volume and density of the food.

---

## Cookware and Dinnerware

Cookware and dinnerware must fit on the turntable. Always use oven mitts or pot holders when handling because any dish may become hot from heat transferred from the food. Do not use cookware and dinnerware with gold or silver trim. Use the following chart as a guide, then test before using.

MATERIAL	RECOMMENDATIONS
Aluminum Foil, Metal	See "Aluminum Foil and Metal" section.
Browning Dish	Bottom must be at least $\frac{3}{16}$ in. (5 mm) above the turntable. Follow manufacturer's recommendations.
Ceramic Glass, Glass	Acceptable for use.
China, Earthenware	Follow manufacturer's recommendations.
Melamine	Follow manufacturer's recommendations.
Paper Towels, Dinnerware, Napkins	Use non-recycled and those approved by the manufacturer for microwave oven use.
Plastic Wraps, Bags, Covers, Dinnerware, Containers	Use those approved by the manufacturer for microwave oven use.
Pottery and Clay	Follow manufacturer's recommendations.
Styrofoam®	Do not use in oven.
Straw, Wicker, Wooden Containers	Do not use in oven.
Wax Paper	Acceptable for use.

---

### To Test Cookware or Dinnerware for Microwave Use:

1. Put cookware or dinnerware in oven with 1 cup (250 mL) of water beside it.
2. Cook at 100% cooking power for 1 minute.

Do not use cookware or dinnerware if it becomes hot and the water stays cool.

## Aluminum Foil and Metal

Always use oven mitts or pot holders when removing dishes from the microwave oven.

Aluminum foil and some metal can be used in the oven. If not used properly, arcing (a blue flash of light) can occur and cause damage to the oven.

### OK for Use

Racks and bakeware supplied with the oven, aluminum foil for shielding, and approved meat thermometers may be used with the following guidelines:

- Never allow aluminum foil or metal to touch the inside cavity walls, ceiling or floor.
- Always use the turntable.
- Never allow contact with another metal object during cooking.

### Do Not Use

Metal cookware and bakeware, gold, silver, pewter, non-approved meat thermometers, skewers, twist ties, foil liners such as sandwich wrappers, staples and objects with gold or silver trim or a metallic glaze should not be used in the oven.

## Inverter Microwave System

The Inverter Microwave System is proven technology that delivers a constant stream of microwave power – true high, medium and low power.

Typically, microwave ovens operate on HIGH power only. For example, to achieve a 50% power level (“medium”) in a typical microwave oven, the oven operates 50% of the time at HIGH power and 50% of the time OFF.

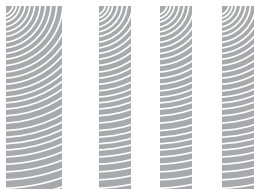

In contrast, microwave ovens utilizing the Inverter Microwave System deliver the selected power level continuously. This constant stream of microwave power helps to minimize overcooking of foods and messy food spatters.

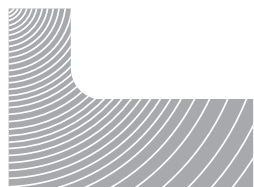

## Sensor Cooking

The Inverter Microwave System features the 6th Sense™ cooking system. A humidity sensor in the oven cavity detects moisture and humidity emitted from food as it heats. The sensor adjusts cooking times to various types and amounts of food. Sensor cooking takes the guesswork out of microwave cooking.

## Cooking Power

Many recipes for microwave cooking specify which cooking power to use by percent, name or number. For example, 70%=7=Medium-High.

Use the following chart as a general guide for the suggested cooking power of specific foods.

PERCENT/ NAME	NUMBER	USE
100%, High (default setting)	10	Quick heating convenience foods and foods with high water content, such as soups, beverages and most vegetables.
90%	9	Cooking small tender pieces of meat, ground meat and poultry pieces. Heating cream soups.
80%	8	Heating rice, pasta or casseroles. Cooking and heating foods that need a cook power lower than high, such as meat loaf.
70%, Medium-High	7	Reheating a single serving of food. Cooking fish fillets.
60%	6	Cooking sensitive foods such as cheese and egg dishes, pudding and custards. Cooking non-stirrable casseroles, such as lasagna.
50%, Medium	5	Cooking ham, whole poultry, whole fish and pot roasts. Simmering stews.
40%	4	Heating bread, rolls and pastries.
30%, Medium-Low, Defrost	3	Defrosting bread, fish, meats, poultry and precooked foods.
20%	2	Melting chocolate, butter and marshmallows. Softening ice cream.
10%, Low	1	Taking chill out of fruit. Softening butter and cheese.

### To Set a Cooking Power other than 100%:

1. Touch COOK TIME.
2. Touch the number pads to set a length of time to cook.
3. Touch COOK POWER.
4. Touch the number pad using the Cooking Power chart.
5. Touch JET START.

The display will count down the cook time.

When the cycle ends, "END" will appear in the display, 4 end-of-cycle tones will sound, and then reminder tones will sound every minute.

6. Touch OFF/CANCEL or open the door to clear the display and/or stop reminder tones.

---

## Cooking

### To Use:

1. Touch COOK TIME.
2. Touch the number pads to set a length of time to cook.  
Touch COOK POWER to set a cooking power other than 100%. Touch the number pad(s) using the Cooking Power chart.

3. Touch JET START.

The display will count down the cook time.

When the cycle ends, "END" will appear in the display, 4 end-of-cycle tones will sound, and then reminder tones will sound every minute.

4. Touch OFF/CANCEL or open the door to clear the display and/or stop reminder tones.

The cook time and cooking power can be changed at any time after touching JET START by repeating the above steps.

---

## 6th Sense™ System Cooking

A sensor in the microwave oven detects humidity released from the food and automatically sets a cooking time based on the selected pad.

Use the following chart as a guide for the 3 SENSOR pads.

FOOD	SERVING SIZE	INSTRUCTIONS
*Popcorn	3.5 oz (100 g) 3 oz (85 g) 1.75 oz (50 g)	Pop only one package at a time.
Baked Potatoes	1 to 4 medium, 10 to 13 oz (264 to 369 g) each	Pierce each one several times with a fork. Place on turntable around edges, at least 1 in. (2.5 cm) apart. At the end of cooking, let stand 5 minutes.
Dinner Plate	1 serving (1 plate), 8 to 16 oz (.2 to .45 kg)	Place food on plate, cover with plastic wrap and vent.

\*Do not use regular paper bags or glass utensils. Listen for popping to slow to 1 pop every 1 or 2 seconds. Do not try to pop unpopped kernels. Use fresh bags of popcorn for optimal results. Cooking results may vary by brand and fat content. If using a microwave popcorn popper, follow manufacturer's instructions.

---

### To Use the 6th Sense™ System:

Before using, make sure the microwave oven has been plugged in for at least 2½ minutes, the room temperature is not above 95°F (35°C) and the outside of the container and microwave oven cavity are dry.

1. Touch one of the SENSOR pads.

The microwave oven will automatically turn on when POPCORN, BAKED POTATOES or DINNER PLATE is touched. The Progress Bar will show the approximate time remaining.

When the cycle ends, "END" will appear in the display, 4 end-of-cycle tones will sound, and then reminder tones will sound every minute.

2. Touch OFF/CANCEL or open the door to clear the display and/or stop reminder tones.

The cook time (except for POPCORN) can be changed for twenty seconds after touching a pad.

**To Change Cook Time:** Touch COOK POWER repeatedly to scroll through "MORE," "LESS" or "NORML" time.

---

## Pre-Set Cooking

Times and cooking power have been preset for seven microwavable foods. Use the following chart as a guide.

FOOD	CODE	QUANTITY/ INSTRUCTION
Canned Vegetables	1	1, 2, 3 or 4 cups (250, 500 or 750 mL, or 1 L)
*Fresh Vegetables (sensor)	2	1 to 4 cups (250 mL to 1 L)/ Add 1 tbsp water per cup veg. Cover with plastic and ventilate.
*Frozen Vegetables (sensor)	3	1 to 4 cups (250 mL to 1 L)/ Add 1 tbsp water per cup veg. Cover with plastic and ventilate.
*Rice (sensor)	4	.5 to 2 cups (125 mL to 500 mL)
French Toast, frozen	5	1, 2, 3 or 4 pieces
**Bacon	6	1, 2, 3, 4, 5 or 6 pieces, average thickness
*Frozen Entrée (sensor)	7	10 to 20 oz (285 to 570 g)/ Loosen, but do not remove plastic.

\*Make sure the microwave oven has been plugged in for at least 2½ minutes. No quantity needs to be entered. The amount listed is the amount to cook.

\*\*Differences in the amount of fat, meat, thickness, and curing process affect results. Average is 16 slices per pound.

### To Use Pre-Set Cooking:

1. Touch COOK.
2. Touch number pad from chart  
or  
Touch COOK repeatedly to scroll through foods.
3. Touch number pads to enter quantity (for Canned Vegetables, French Toast and Bacon only).  
The sensor will determine quantities and cook times for Fresh Vegetables, Frozen Vegetables, Rice and Frozen Entrée.  
Doneness may be adjusted at this time by touching COOK POWER.
4. Touch JET START.  
The display will count down the cook time.  
When the cycle ends, "END" will appear in the display, 4 end-of-cycle tones will sound, and then reminder tones will sound every minute.
5. Touch OFF/CANCEL or open the door to clear the display and/or stop reminder tones.

---

## Beverage

Beverages may be heated in the microwave oven by touching the BEVERAGE pad. One or two 8-oz. (250 mL) cups can be heated automatically using this function.

### To Use BEVERAGE:

1. Touch BEVERAGE.  
The display will show the setting for heating 1 cup.
2. Touch BEVERAGE a second time to heat 2 cups.  
The microwave oven will start 5 seconds after the appropriate number of cups to be heated is selected. The display will count down the cook time.  
If more or less time is required, touch COOK POWER before the oven starts cooking.  
When the cycle ends, "END" will appear in the display, 4 end-of-cycle tones will sound, and then reminder tones will sound every minute.
3. Touch OFF/CANCEL or open the door to clear the display and/or stop reminder tones.

---

## Cooking in Stages

The oven can be set to cook at different cooking powers for various lengths of time, up to three stages. Cook settings can be used in any order, except defrosting, which must be the first stage.

Sensor cooking cannot be done in stages.

### To Cook in Stages:

1. Touch COOK TIME.
  2. Touch number pads to enter length of time to cook during the first stage.
  3. Touch COOK POWER.
  4. Touch the number pad(s) using the Cooking Power chart to set the cooking power for the first cycle.
  5. Repeat steps 1-4 for the second and third cycles.
  6. Touch JET START.  
The display will count down each of the cook times. A "1," "2" or "3" will appear on the display during their respective stages.  
When the cycle ends, "END" will appear in the display, 4 end-of-cycle tones will sound, and then reminder tones will sound every minute.
  7. Touch OFF/CANCEL or open the door to clear the display and/or stop reminder tones.  
The cook time and cooking power of the cycling stage can be changed after touching JET START without interrupting cooking.
- To Change Cook Time:** Touch COOK TIME. Use the number pads to enter the new cook time. Touch JET START.
- To Change Cooking Power:** Touch COOK POWER. Use the number pads to enter the new cooking power or repeatedly touch COOK POWER. Touch JET START.

## Reheating

Times and cooking power have been preset for reheating five specific foods. Use the following chart as a guide.

FOOD	CODE	QUANTITY/ INSTRUCTION
*Pizza Slice (sensor)	1	1 to 3 slices, 5 oz (142 g) each
Casserole	2	1, 2, 3 or 4 cups (250, 500 or 750 mL, or 1 L)
*Soup (sensor)	3	1 to 4 cups (250 mL to 1 L)/ Cover with plastic and ventilate.
*Sauce (sensor)	4	1 to 4 cups (250 mL to 1 L)/ Cover with plastic and ventilate.
Baked Goods (example: medium muffin or bagel)	5	1, 2, 3, 4, 5 or 6 pieces, 2 oz (57 g) each

\*Make sure the microwave oven has been plugged in for at least 2½ minutes.

### To Use Reheat:

1. Touch REHEAT.
2. Touch number pad from chart  
or  
Touch REHEAT repeatedly to scroll through foods.
3. Touch number pads to enter quantity for Casserole and Baked Goods only.  
The sensor will determine quantities for Pizza Slice, Soup and Sauce.  
Reheat time may be adjusted at this time by touching COOK POWER.
4. Touch JET START.  
The display will count down the reheat time.  
When the cycle ends, "END" will appear in the display, 4 end-of-cycle tones will sound, and then reminder tones will sound every minute.
5. Touch OFF/CANCEL or open the door to clear the display and/or stop reminder tones.

## Defrosting

The automatic Defrost control can be used or the microwave oven can be manually set to defrost.

- Food should be 0°F (-18°C) or colder at defrosting for optimal results.
- Unwrap foods and remove lids (from fruit juice) before defrosting.
- Shallow packages will defrost more quickly than deep blocks.
- Separate food pieces as soon as possible during or at the end-of-cycle for more even defrosting.
- Use small pieces of aluminum foil to shield parts of food such as chicken wings, leg tips and fish tails. See "Aluminum Foil and Metal" first.

The automatic Defrost control has three categories: Meat, Poultry and Fish. It should not be used for food left outside the freezer more than 20 minutes and frozen ready-made food. Use the following chart as a guide.

### MEAT

<i>Beef:</i> ground, steaks, roast, stew	The narrow or fatty areas of irregular shaped cuts should be shielded with foil before defrosting.
<i>Lamb:</i> stew and chops	Do not defrost less than ¼ lb (113 g) or two 4 oz (113 g) patties.
<i>Pork:</i> chops, ribs, roasts, sausage	Place all meats in microwavable baking dish.

### POULTRY

<i>Chicken:</i> whole and cut up	Place in microwavable baking dish, chicken breast-side up.
<i>Cornish hens</i>	Remove giblets from whole chicken.
<i>Turkey:</i> breast	

### FISH

<i>Fillets, Steaks, Whole, Shellfish</i>	Place in microwavable baking dish.
--	------------------------------------

### To use the Defrost control:

1. Touch DEFROST.
2. Touch the number pad 1 for Meat, 2 for Poultry or 3 for Fish  
or  
Touch DEFROST repeatedly to scroll through foods.
3. Touch the number pads to enter the weight.  
Meats and Poultry can be set from .2 to 6.6 lb (91 g to 3 kg).  
Fish can be set from .2 to 4.4 lb (91 g to 2 kg).  
Defrost time may be adjusted at this time by touching COOK POWER.
4. Touch JET START.  
The display will count down the defrost time.  
When the cycle ends, "END" will appear in the display, 4 end-of-cycle tones will sound, and then reminder tones will sound every minute.
5. Touch OFF/CANCEL or open the door to clear the display and/or stop reminder tones.

### To Defrost manually:

1. Touch the number pads to set a length of time to defrost.
2. Touch COOK POWER.
3. Touch 3.
4. Touch JET START.

The display will count down the defrost time.

When the cycle ends, "END" will appear in the display, 4 end-of-cycle tones will sound, and then reminder tones will sound every minute.

5. Touch OFF/CANCEL or open the door to clear the display and/or stop reminder tones.

## Soften

The microwave oven uses low power to soften certain foods. Butter and cream cheese will be room temperature so they will be ready to use in a recipe. Ice cream will be softened enough to make scooping easier. Use the following chart as a guide.

FOOD	CODE	SOFTEN PAD	QUANTITY
Butter	1	1 time	1, 2 or 3 sticks
Ice cream	2	2 times	16, 32 or 64 oz
Cream cheese	3	3 times	3 oz or 8 oz

### To Soften:

1. Touch SOFTEN.  
The display will alternate between showing "SOFTN" and "PAD".
2. Touch SOFTEN repeatedly to scroll through the Soften menu items  
or  
Touch number pad to select Soften menu item.
3. Enter quantity of food items using the prompts on the display or the quantities from the chart above. Only pads valid for the selected food class will give a response.  
Doneness may be adjusted at this time by touching COOK POWER.
4. Touch JET START.  
The display will count down the soften time.  
When the cycle ends, "END" will appear on the display, 4 end-of-cycle tones will sound, and then reminder tones will sound every minute for 15 minutes.

## Melt

The microwave oven uses low power to melt certain foods. The foods may not be completely melted when the program ends, but stirring the food will complete the melting. Use the following chart as a guide.

FOOD	CODE	MELT PAD	QUANTITY
Butter	1	1 time	1, 2 or 3 sticks
Chocolate (chips or baking squares)	2	2 times	4 oz or 8 oz
Cheese (processed cheese food)	3	3 times	8 oz or 16 oz
Marshmallows (large or small)	4	4 times	5 oz or 10 oz

### To Melt:

1. Touch MELT.  
The display will alternate between showing "MELT" and "PAD".
2. Touch MELT repeatedly to scroll through the Melt menu items  
or  
Touch number pad to select Melt menu item.
3. Enter quantity of food items using the prompts on the display or the quantities from the chart above. Only pads valid for the selected food class will give a response.  
Doneness may be adjusted at this time by touching COOK POWER.
4. Touch JET START.  
The display will count down the melt time.  
When the cycle ends, "END" will appear on the display, 4 end-of-cycle tones will sound, and then reminder tones will sound every minute for 15 minutes.

## Kids Menu

The Kids Menu function is preset with cooking times and cook powers for several typical children's menu items that are cooked in the microwave oven. Use the following chart as a guide.

FOOD	CODE	KIDS MENU PAD	QUANTITY/ INSTRUCTION
*Canned pasta	1	1 time	1, 2, 3 or 4 servings/ Follow food label instructions.
Frozen Pizza	2	2 times	5-7 oz/ Follow food label instructions.
Frozen Meal	3	3 times	8, 10 or 12 oz/ Follow food label instructions.
Hot Dogs	4	4 times	1, 2, 3 or 4 pieces/ Use paper plate. Cook without bun.
Hot Cereal (oatmeal)	5	5 times	1 or 2 servings/ Follow food label instructions.
Chicken Nuggets	6	6 times	1 or 2 servings/ Place nuggets on paper plate covered with paper towel.

\* This function is not intended for meal-in-a-cup products.

### To Use Kids Menu:

- Touch KIDS MENU.  
The display will show "PAD -".
- Touch KIDS MENU repeatedly to scroll through the Kids Menu items  
or  
Touch number pad to select Kids Menu item.  
The display will show the name of the selected menu item for 2-3 seconds, and then prompt for the quantity of food to be entered.
- Enter quantity of food items using the prompts on the display or the quantities from the chart above. Only pads valid for the selected food class will give a response.  
Doneness may be adjusted at this time by touching COOK POWER.
- Touch JET START.  
The display will count down the cook time.  
When the cycle ends, "END" will appear on the display, 4 end-of-cycle tones will sound, and then reminder tones will sound every minute for 15 minutes.

## Simmer Cooking and Steaming

Use the Simmer Cook function for foods such as soups, casseroles, stews and other liquid food. It can also be used to cook pasta.

### To Simmer:

Before using, make sure the microwave oven has been plugged in for at least 2½ minutes. Add ¼ to ½ cup (60 to 125 mL) of water to vegetables and cover dish with its lid, not plastic wrap.

- Touch STEAM/SIMMER.
- Touch the number pads to set a length of time to simmer.
- Touch JET START.  
"BOIL" will appear on the display. When water begins to boil, the display will count down the simmer time.  
When the cycle ends, "END" will appear in the display, 4 end-of-cycle tones will sound, and then reminder tones will sound every minute.
- Touch OFF/CANCEL or open the door to clear the display and/or stop reminder tones.

### Simmering Pasta

Use a container large enough to cover food completely with water. Add 1 tablespoon (15 mL) oil to water. Put container and water in the microwave oven and follow the above steps, setting a simmer time of one second. When time ends place food in the water. Cover, then follow the above steps setting the desired simmer time.

### Tupperware® Microsteamer

Use the Tupperware Microsteamer, (provided with the microwave oven) with the Steam Cook feature to steam foods.

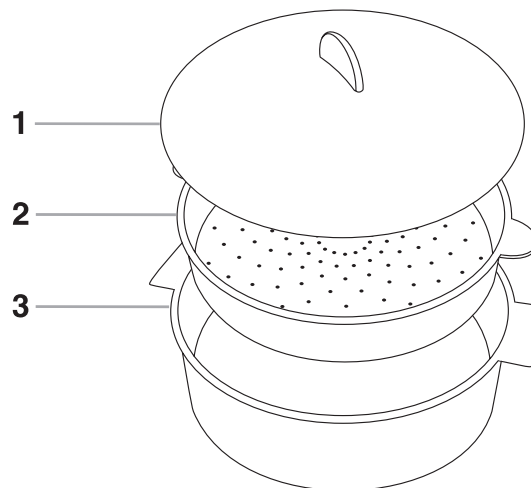

1. Cooking cover  
2. Colander  
3. Dish

See "General Cleaning" section for additional information.

- The Tupperware Microsteamer will become hot. Always use oven mitts or pot holders when handling.
- Do not use in a conventional or combination-type oven, with "Crisp" or "Grill" functions or on electric or gas burners.
- To avoid scratching, use plastic utensils.
- Do not overfill. One-half full is recommended.

**Cooking Cover:** Always use when cooking. Place directly over the colander and dish or just the dish.

**Colander:** Use for foods such as fish, vegetables and potatoes. Do not use with foods such as rice, pasta and white beans. When using, place directly over the dish.

**Dish:** Use for foods such as rice and pasta.

### To Steam:

Before using, make sure the microwave oven has been plugged in for 2½ minutes and fill the dish with at least ¼ cup (60 mL) of water when using the colander. More water may be needed when not using the colander. Place Microsteamer on center of turntable.

1. Touch STEAM/SIMMER.
2. Touch number pads to enter length of time to steam.
3. Touch JET START.  
“BOIL” will appear on the display. When water begins to boil the display will count down the steam time.  
When the cycle ends, “END” will appear in the display, 4 end-of-cycle tones will sound, and then reminder tones will sound every minute.
4. Touch OFF/CANCEL or open the door to clear the display and/or stop reminder tones.

## Warm Hold

### **WARNING**

#### Food Poisoning Hazard

**Do not let food sit in oven more than one hour before or after cooking.**

**Doing so can result in food poisoning or sickness.**

Hot cooked food can be kept warm in the microwave oven. Warm Hold can be used by itself or can be programmed to follow a cooking cycle. Opening the door during Warm Hold will cancel the function.

### To Use:

Put hot cooked food in the oven. Cover plates of food and foods that were cooked covered. Pastries, pies, turnovers, etc. should remain uncovered.

1. Touch WARM HOLD.
2. Touch JET START.  
“WARM” will appear on the display during the entire cycle.  
When the cycle ends, “END” will appear in the display, 4 end-of-cycle tones will sound, and then reminder tones will sound every minute.
3. Touch OFF/CANCEL or open the door to clear the display and/or stop reminder tones.

**To Set at end of cycle:** Touch WARM HOLD while setting a cooking cycle before touching JET START, or during cooking.

# MICROWAVE OVEN CARE

## General Cleaning

**IMPORTANT:** Before cleaning, make sure all controls are off and the oven is cool. Always follow label instructions on cleaning products.

Soap, water and a soft cloth or sponge are suggested first unless otherwise noted.

### GREASE FILTERS

Do not operate the microwave oven without the grease filters in place.

Soak grease filters in hot water and mild detergent. Scrub and swish to remove embedded dirt. Rinse well and shake dry.

- Do not use ammonia or oven cleaner.
- Do not place in dishwasher.

### OVEN CAVITY

Do not use soap-filled scouring pads, abrasive cleaners, steel-wool pads, gritty wash cloths or some paper towels. Damage may occur.

The area where the oven door and frame touch when closed should be kept clean.

#### Average soil

- Mild, non-abrasive soaps and detergents:  
Rinse with clean water and dry with soft, lint-free cloth.

#### Heavy soil

- Mild, non-abrasive soaps and detergents:  
Heat 1 cup (250 mL) of water for 2 to 5 minutes in oven. Steam will soften soil. Rinse with clean water and dry with soft, lint-free cloth.

#### Odors

- Lemon juice or vinegar:  
Heat 1 cup (250 mL) of water with 1 tablespoon (15 mL) of either lemon juice or vinegar for 2 to 5 minutes in oven.

### OVEN DOOR EXTERIOR

- Glass cleaner and paper towels or non-abrasive plastic scrubbing pad:  
Apply glass cleaner to soft cloth or sponge, not directly on panel.



---

## THE TUPPERWARE® MICROSTEAMER

---

- Soft brush, if necessary, to clean holes.
- Dishwasher:  
The Tupperware Microsteamer is dishwasher safe.

### Stubborn Stains

To remove stains such as tomato sauce, use a nonabrasive cleanser, a no-scratch pad, or a solution of dishwasher detergent and water (¼ cup detergent to 1 cup warm water).

---

## TURNTABLE

---

- Do not operate the microwave without the turntable in place.
- Mild cleanser and scouring pad
  - Dishwasher

## Replacing Filters

The grease filters should be removed and cleaned at least once a month. The charcoal filter cannot be washed and should be replaced every six to twelve months. Do not operate the microwave oven without the filters in place. See “Assistance or Service” to reorder filters. See “General Cleaning” for cleaning instructions.

## ⚠ WARNING



### Electrical Shock Hazard

**Disconnect power before removing filters.**

**Replace all panels before operating.**

**Failure to do so can result in death or electrical shock.**

### To Remove:

1. Unplug microwave oven or disconnect power.
2. Remove each of the grease filters by pushing the back of the filter up, grasping the tab, and sliding the filter to the back. Pull tab down until the filter drops out.

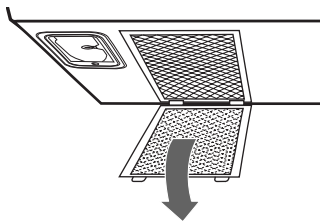

3. Remove charcoal filters by pushing the filter to the right until the left side of the filter slides off the left lower lip. Swing the left side of the filter down and slide out.

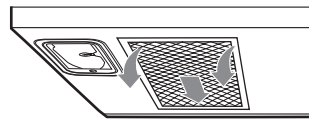

### To Replace:

1. Replace charcoal filters by positioning the filter at the left of the opening, between the upper and lower lips. Swing the filter up against the upper lip. Slide filter to the right while pushing it up against the upper lip. The filter will now be held in position between the lips.
2. Replace grease filters by inserting the end without the tab into the frame. Swing other side up and slide into position.
3. Plug in microwave oven or reconnect power.

## Replacing Cooktop Light

The cooktop light is a 10W low-voltage halogen capsule bulb. See “Assistance or Service” section to reorder.

### To Replace:

1. Unplug microwave oven or disconnect power.
2. Remove bulb cover mounting screw, and carefully remove cover.

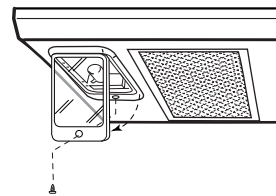

3. Remove the burnt-out bulb.
4. Replace bulb, using a tissue to handle the bulb, or wearing cotton gloves. Do not touch bulb with bare fingers.
5. Replace bulb cover and mounting screw.
6. Plug in microwave oven or reconnect power.

---

## Replacing Microwave Oven Light

The microwave oven light is a candelabra base 30-watt bulb. It will automatically come on when the door is opened and when the microwave oven is operating. See “Assistance or Service” section to reorder.

### To Replace:

1. Unplug microwave or disconnect power.
2. Pull the vent grille out of the snaps fitting.

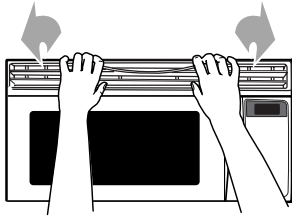

3. Lift up the bulb cover.

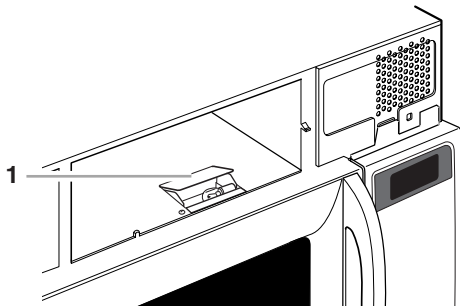

1. Bulb cover

4. Replace light. Close bulb cover.
5. Slide the bottom of the vent grille into place. Push the top until it snaps into place.

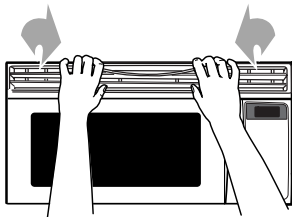

6. Plug in microwave oven or reconnect power.

---

## TROUBLESHOOTING

Try the solutions suggested here first in order to avoid the cost of an unnecessary service call.

---

### Nothing will operate

- **Has a household fuse been blown or has the circuit breaker been tripped?**  
Replace the fuse or reset the circuit.
- **Is the appliance wired properly?**  
See Installation Instructions.

---

### Oven will not operate

- **Is the door completely closed?**  
Firmly close door.
- **Is the electronic oven control set correctly?**  
See “Microwave Oven Control” section.
- **On some models, is the Control Lock set?**  
See “Control Lock” section.
- **Is the magnetron working properly?**  
Heat 1 cup (250 mL) of cold water for 2 minutes at 100% cooking power. If water does not heat, call for service. See “Assistance or Service” section.

---

### Oven makes humming noise

- This is normal and occurs when the power supply switches the magnetron on and off.

---

### Oven door looks wavy

- This is normal and will not affect performance.

---

### Turntable will not operate

- **Is the turntable properly in place?**  
Make sure turntable is correct-side up and is sitting securely on the turntable support.
- **Is the turntable support operating properly?**  
Remove turntable. Remove and replace turntable support. Replace turntable. Put in 1 cup (250 mL) of water, then restart oven. If still not working, call for service. See “Assistance or Service” section. Do not operate the oven without turntable and turntable support working properly.

---

### Turntable rotates both directions

- This is normal and depends on motor rotation at beginning of cycle.

---

### Display shows messages

- **Is the display showing “:”?**  
There has been a power failure or the clock time has been turned off. See “Display” section to clear display. See “Clock” section to reset the clock or to turn it on.
- **Is the display showing a letter followed by a number?**  
See “Display” section to clear. If it reappears, call for service. See “Assistance or Service” section.

---

### Display shows time countdown, but is not operating

---

- **Is the Timer in use?**  
See “Timer” section.
- **On some models, is the Demo Learning Mode in use?**  
See “Demo Learning Mode” section.

---

### Tones are not sounding

---

- **Are tones turned off?**  
See “Tones” section.

---

### Steam is coming from the vent grille

---

- Some steam is normal.

---

### Fan running slower than usual

---

- The oven has been stored in a cold area. The fan will run slower until the oven warms up to normal room temperature.

---

### Cooking times seem too long

---

- **Is the cooking power set properly?**  
See “Cooking Power” section.
- **Are large amounts of food being heated?**  
Larger amounts of food need longer cooking times.
- **Is the incoming voltage less than specified in “Microwave Oven Safety”?**  
Have a qualified electrician check the electrical system in the home.

---

### Radio or TV Interference

---

- **Is the microwave oven plugged into the same outlet?**  
Try a different outlet.
- **Is the radio or TV receiver near the microwave oven?**  
Move the receiver away from the microwave oven, or adjust the radio or TV antenna.
- **Is the microwave oven door and sealing surfaces clean?**  
Make sure these areas are clean.

---

## ASSISTANCE OR SERVICE

Before calling for assistance or service, please check “Troubleshooting.” It may save you the cost of a service call. If you still need help, follow the instructions below.

When calling, please know the purchase date and the complete model and serial number of your appliance. This information will help us to better respond to your request.

### If you need replacement parts

If you need to order replacement parts, we recommend that you only use FSP® replacement parts. FSP® replacement parts will fit right and work right because they are made with the same precision used to build every new WHIRLPOOL® appliance.

To locate FSP® replacement parts in your area, call our Customer Interaction Center telephone number or your nearest Whirlpool designated service center.

---

## In the U.S.A.

Call the Whirlpool Customer Interaction Center toll free: **1-800-253-1301**.

### Our consultants provide assistance with:

- Features and specifications on our full line of appliances.
- Installation information.
- Use and maintenance procedures.
- Accessory and repair parts sales.
- Specialized customer assistance (Spanish speaking, hearing impaired, limited vision, etc.).
- Referrals to local dealers, repair parts distributors, and service companies. Whirlpool designated service technicians are trained to fulfill the product warranty and provide after-warranty service, anywhere in the United States.

To locate the Whirlpool designated service company in your area, you can also look in your telephone directory Yellow Pages.

### For further assistance

If you need further assistance, you can write to Whirlpool Corporation with any questions or concerns at:

Whirlpool Brand Home Appliances  
Customer Interaction Center  
553 Benson Road  
Benton Harbor, MI 49022-2692

Please include a daytime phone number in your correspondence.

### Replacement Parts

Turntable  
Part No. 4393751  
Turntable Support  
Part No. 8181402  
Turntable Rollers  
Part No. 4393861  
Turntable Hub  
Part No. 8183749  
Cooking Rack  
Part No. 8184052  
Grease Filters  
Part No. 8184001  
Charcoal Filters  
Part No. 8184002  
Microwave Light Bulb  
Part No. 8183993  
Cooktop Halogen Bulb  
Part No. 8169418

---

# WHIRLPOOL® MICROWAVE HOOD COMBINATION WARRANTY

---

## ONE-YEAR FULL WARRANTY

For one year from the date of purchase, when this appliance is operated and maintained according to instructions attached to or furnished with the product, Whirlpool Corporation will pay for FSP® replacement parts and repair labor to correct defects in materials or workmanship. Service must be provided by a Whirlpool designated service company.

---

## SECOND THROUGH FIFTH YEAR LIMITED WARRANTY ON MAGNETRON TUBE

From the second through fifth year from the date of purchase, when this appliance is operated and maintained according to instructions attached to or furnished with the product, Whirlpool Corporation will pay for FSP® replacement parts for the microwave magnetron tube if defective in materials or workmanship.

---

### Whirlpool Corporation will not pay for:

1. Service calls to correct the installation of your appliance, to instruct you how to use your appliance, to replace house fuses or correct house wiring, or to replace owner-accessible light bulbs and filters.
  2. Repairs when your appliance is used in other than normal, single-family household use.
  3. Pickup and delivery. Your appliance is designed to be repaired in the home.
  4. Damage resulting from accident, alteration, misuse, abuse, fire, flood, improper installation, acts of God or use of products not approved by Whirlpool Corporation.
  5. Repairs to parts or systems resulting from unauthorized modifications made to the appliance.
  6. Replacement parts or repair labor costs for units operated outside the United States.
  7. Any labor costs during the limited warranty period.
- 

### WHIRLPOOL CORPORATION SHALL NOT BE LIABLE FOR INCIDENTAL OR CONSEQUENTIAL DAMAGES.

Some states do not allow the exclusion or limitation of incidental or consequential damages, so this exclusion or limitation may not apply to you. This warranty gives you specific legal rights and you may also have other rights which may vary from state to state.

**Outside the 50 United States, this warranty does not apply. Contact your authorized Whirlpool dealer to determine if another warranty applies.**

If you need service, first see the "Troubleshooting" section of this book. After checking "Troubleshooting," additional help can be found by checking the "Assistance or Service" section or by calling the Whirlpool Customer Interaction Center, **1-800-253-1301** (toll-free), from anywhere in the U.S.A.

5/00

---

**Keep this book and your sales slip together for future reference. You must provide proof of purchase or installation date for in-warranty service.**

Write down the following information about your appliance to better help you obtain assistance or service if you ever need it. You will need to know your complete model number and serial number. You can find this information on the model and serial number label/plate, located on your appliance as shown in the "Parts and Features" section.

Dealer name \_\_\_\_\_

Address \_\_\_\_\_

Phone number \_\_\_\_\_

Model number \_\_\_\_\_

Serial number \_\_\_\_\_

Purchase date \_\_\_\_\_

