



MICROWAVE HOOD COMBINATION

Use And Care

G U I D E



- A Note to You**2
- Microwave Oven Safety**3
- Getting to Know Your Microwave Oven**...6
 - How your microwave oven works6
 - Radio interference6
 - For the best cooking results6
 - Testing your dinnerware or cookware.....7
 - Operating tips7
 - Electrical connections7
 - Microwave oven features8
 - Control panel features9
 - Audible signals11
 - Interrupting cooking.....11
- Microwave Oven Use**.....11
 - Using the safety lock11
 - Using the HELP feature11
 - Using the fan12
 - Using the cooktop/countertop light12
 - Using the bi-level cooking rack12
 - Setting the clock13
 - Using the Minute Timer.....13
 - Cooking at high cook power13
 - Cooking at different cook powers14
 - Cooking with more than one cook cycle ..15
 - Using AUTO DEFROST16
 - Defrosting tips17
 - Using WARM HOLD17
 - Using PERSONAL CHOICE18
 - Sensor cooking guide18
 - Using SENSOR COOK19
 - Using SENSOR REHEAT19
 - Using SENSOR BAKED POTATO20
 - Using SENSOR POPCORN20
 - Using SENSOR PIZZA REHEAT20
 - Using SENSOR VEGETABLE21
 - Using ADD MINUTE21
 - Adding or subtracting cook time21
- Cooking Guide**22
- Microwave Oven Care**23
 - Caring for the filters24
 - Replacing the cooktop and oven lights ..25
- Questions and Answers**.....27
- Troubleshooting**.....28
- Assistance or Service**29
- Warranty**32

1-800-253-1301

Call our Customer Interaction Center
with questions or comments.

A Note to You

Thank you for buying a WHIRLPOOL® appliance.

The Whirlpool Brand is committed to designing quality products that consistently perform for you to make your life easier. To ensure that you enjoy years of trouble-free operation, we developed this Use and Care Guide. It is full of valuable information about how to operate and maintain your appliance properly. Please read it carefully.

Also, complete and mail the Product Registration Card provided with your appliance. The card helps us notify you about any new information on your appliance.

Please record your model's information.

Whenever you call to request service for your appliance, you need to know your complete model number and serial number. You can find this information on the model and serial number label/plate (see the diagram in the "Getting to Know Your Microwave Oven" section).

Please also record the purchase date of your appliance and your dealer's name, address, and telephone number.

Model Number _____

Serial Number _____

Purchase Date _____

Dealer Name _____

Dealer Address _____

Dealer Phone _____

Keep this book and the sales slip together in a safe place for future reference. It is important for you to save your sales receipt showing the date of purchase. Proof of purchase will assure you of in-warranty service.

**Our Customer Interaction Center
number is toll free.**

1-800-253-1301

To find detailed product information, the location of the nearest Whirlpool dealer or designated servicer, to purchase an accessory item, or register your appliance on-line, please visit our Web site at www.whirlpool.com

Microwave Oven Safety

Your safety and the safety of others are very important.

We have provided many important safety messages in this manual and on your appliance. Always read and obey all safety messages.



This is the safety alert symbol.

This symbol alerts you to potential hazards that can kill or hurt you and others.

All safety messages will follow the safety alert symbol and either the word "DANGER" or "WARNING." These words mean:

 **DANGER**

You can be killed or seriously injured if you don't immediately follow instructions.

 **WARNING**

You can be killed or seriously injured if you don't follow instructions.

All safety messages will tell you what the potential hazard is, tell you how to reduce the chance of injury, and tell you what can happen if the instructions are not followed.

IMPORTANT SAFETY INSTRUCTIONS

When using electrical appliances basic safety precautions should be followed, including the following:

WARNING: To reduce the risk of burns, electric shock, fire, injury to persons, or exposure to excessive microwave energy:

- Read all instructions before using the microwave oven.
- Read and follow the specific "PRECAUTIONS TO AVOID POSSIBLE EXPOSURE TO EXCESSIVE MICROWAVE ENERGY" found in this section.
- The microwave oven must be grounded. Connect only to properly grounded outlet. See "GROUNDING INSTRUCTIONS" found at the end of this section.
- Install or locate the microwave oven only in accordance with the provided installation instructions.
- Some products such as whole eggs in the shell and sealed containers – for example, closed glass jars – may explode and should not be heated in the microwave oven.
- Use the microwave oven only for its intended use as described in this manual. Do not use corrosive chemicals or vapors in the microwave oven. This type of oven is specifically designed to heat, cook, or dry food. It is not designed for industrial or laboratory use.
- As with any appliance, close supervision is necessary when used by children.
- Do not operate the microwave oven if it has a damaged cord or plug, if it is not working properly, or if it has been damaged or dropped.

SAVE THESE INSTRUCTIONS

IMPORTANT SAFETY INSTRUCTIONS

- The microwave oven should be serviced only by qualified service personnel. Call an authorized service company for examination, repair, or adjustment.
- See door surface cleaning instructions in the “Microwave Oven Care” section.
- To reduce the risk of fire in the oven cavity:
 - Do not overcook food. Carefully attend the microwave oven if paper, plastic, or other combustible materials are placed inside the oven to facilitate cooking.
 - Remove wire twist-ties from paper or plastic bags before placing bags in oven.
 - If materials inside the oven should ignite, keep oven door closed, turn oven off, and disconnect the power cord, or shut off power at the fuse or circuit breaker panel.
- Do not use the cavity for storage purposes. Do not leave paper products, cooking utensils, or food in the cavity when not in use.
- Suitable for use above both gas and electric cooking equipment.
- Intended to be used above ranges with maximum width of 36 inches (91 cm).
- Clean Ventilating Hoods Frequently - Grease should not be allowed to accumulate on hood or filter.
- When flaming foods under the hood, turn the fan on.
- Use care when cleaning the vent-hood filter. Corrosive cleaning agents, such as lye-based oven cleaners, may damage the filter.

SAVE THESE INSTRUCTIONS

PRECAUTIONS TO AVOID POSSIBLE EXPOSURE TO EXCESSIVE MICROWAVE ENERGY

- (a)** Do not attempt to operate this oven with the door open since open-door operation can result in harmful exposure to microwave energy. It is important not to defeat or tamper with the safety interlocks.
- (b)** Do not place any object between the oven front face and the door or allow soil or cleaner residue to accumulate on sealing surfaces.
- (c)** Do not operate the oven if it is damaged. It is particularly important that the oven door close properly and that there is no damage to the:
 - (1) Door (bent),
 - (2) Hinges and latches (broken or loosened),
 - (3) Door seals and sealing surfaces.
- (d)** The oven should not be adjusted or repaired by anyone except properly qualified service personnel.

Electrical requirements

Observe all governing codes and ordinances. A 120 Volt, 60 Hz, AC only, 15 or 20 amp fused electrical supply is required. (A time-delay fuse is recommended.) It is recommended that a separate circuit serving only this appliance be provided.

⚠ WARNING



Electrical Shock Hazard

Plug into a grounded 3 prong outlet.

Do not remove ground prong.

Do not use an adapter.

Do not use an extension cord.

Failure to follow these instructions can result in death, fire, or electrical shock.

GROUNDING INSTRUCTIONS

- **For all cord connected appliances:** The microwave oven must be grounded. In the event of an electrical short circuit, grounding reduces the risk of electric shock by providing an escape wire for the electric current. The microwave oven is equipped with a cord having a grounding wire with a grounding plug. The plug must be plugged into an outlet that is properly installed and grounded.

WARNING: Improper use of the grounding plug can result in a risk of electric shock.

Consult a qualified electrician or serviceman if the grounding instructions are not completely understood, or if doubt exists as to whether the microwave oven is properly grounded.

Do not use an extension cord. If the power supply cord is too short, have a qualified electrician or serviceman install an outlet near the microwave oven.

- **For a permanently connected appliance:** The microwave oven must be connected to a grounded, metallic, permanent wiring system, or an equipment grounding conductor should be run with the circuit conductors and connected to the equipment grounding terminal or lead on the microwave oven.

SAVE THESE INSTRUCTIONS

Getting to Know Your Microwave Oven

This section discusses the concepts behind microwave cooking. It also shows you the basics you need to know to operate your microwave oven. Please read this information before you use your oven.

How your microwave oven works

Microwave energy is not hot. It causes food to make its own heat, and it's this heat that cooks the food.

Microwaves are like TV waves, radio waves, or light waves. You cannot see them, but you can see what they do.

A magnetron in the microwave oven produces microwaves. The microwaves move into the oven where they contact food as it turns on the turntable.

The glass turntable of your microwave oven lets microwaves pass through. Then they bounce off a metal floor, back through the glass turntable, and are absorbed by the food.

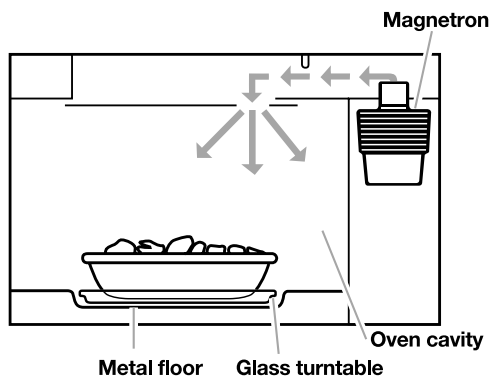

Microwaves pass through most glass, paper, and plastics without heating them so food absorbs the energy. Microwaves bounce off metal containers so food does not absorb the energy.

Radio interference

Using your microwave oven may cause interference to your radio, TV, or similar equipment. When there is interference, you can reduce it or remove it by:

- Cleaning the door and sealing surfaces of the oven.
- Adjusting the receiving antenna of the radio or television.
- Moving the receiver away from the microwave oven.
- Plugging the microwave oven into a different outlet so that the microwave oven and receiver are on different branch circuits.

For the best cooking results

- Always cook food for the shortest cooking time recommended. Check to see how the food is cooking. If needed, touch ADD MINUTE while the oven is operating or after the cooking cycle is over (see the "Using ADD MINUTE" section).
- Stir, turn over, or rearrange the food being cooked about halfway through the cooking time for all recipes. This will help make sure the food is evenly cooked.
- If you do not have a cover for a dish, use wax paper, or microwave-approved paper towels or plastic wrap. Remember to turn back a corner of the plastic wrap to vent steam during cooking.

Testing your dinnerware or cookware

Test dinnerware or cookware before using. To test a dish for use, put it into the oven with a cup of water beside it. Cook at 100% cook power for one minute. If the dish gets hot and water stays cool, do not use it. Some dishes (melamine, some ceramic dinnerware, etc.) absorb microwave energy and may become too hot to handle and slow cooking times. Cooking in metal containers not designed for microwave use could damage the oven, as could containers with hidden metal (twist-ties, foil lining, staples, metallic glaze or trim).

Operating tips

- Never lean on the door or allow a child to swing on it when the door is open.
- Use oven mitts or pot holders when removing containers from oven.
- Do not use newspaper or other printed paper in the oven.
- Do not dry flowers, fruit, herbs, wood, paper, gourds, or clothes in the oven.
- Do not start a microwave oven when it is empty. Product life may be shortened. If you practice programming the oven, put a container of water in the oven. It is normal for the oven door to look wavy after the oven has been running for a while.
- Do not try to melt paraffin wax in the oven. Paraffin wax will not melt in a microwave oven because it allows microwaves to pass through it.
- Do not operate the microwave oven unless the glass turntable is securely in place and can rotate freely. The turntable can rotate in either direction. Make sure the turntable is correct-side up in the oven. Handle your turntable with care when removing it from the oven to avoid possibly breaking it. If your turntable cracks or breaks, contact your dealer for a replacement.
- When you use a browning dish, the browning dish bottom must be at least $\frac{3}{16}$ in. above the turntable. Follow the directions supplied with the browning dish.
- Do not cook or reheat whole eggs or eggs inside the shell. Steam build-up in whole eggs may cause them to burst and damage the oven. Cover poached eggs and allow a standing time.
- Heated liquids can splash out during and after heating. Use of a wooden stir stick placed in the cup or bowl during heating may help to avoid this.
- Microwaves may not reach the center of a roast. The heat spreads to the center from the outer, cooked areas just as in regular oven cooking. This is one of the reasons for letting some foods (for example, roasts or baked potatoes) stand for a while after cooking, or for stirring some foods during the cooking time.
- Do not deep fry in the oven. Microwavable utensils are not suitable and it is difficult to maintain appropriate deep-frying temperatures.
- Do not overcook potatoes. At the end of the recommended cooking time, potatoes should be slightly firm because they will continue cooking during standing time. After microwaving, let potatoes stand for 5 minutes. They will finish cooking while standing.

Electrical connection

If your electric power line or outlet voltage is less than 110 volts, cooking times may be longer. Have a qualified electrician check your electrical system.

Microwave oven features

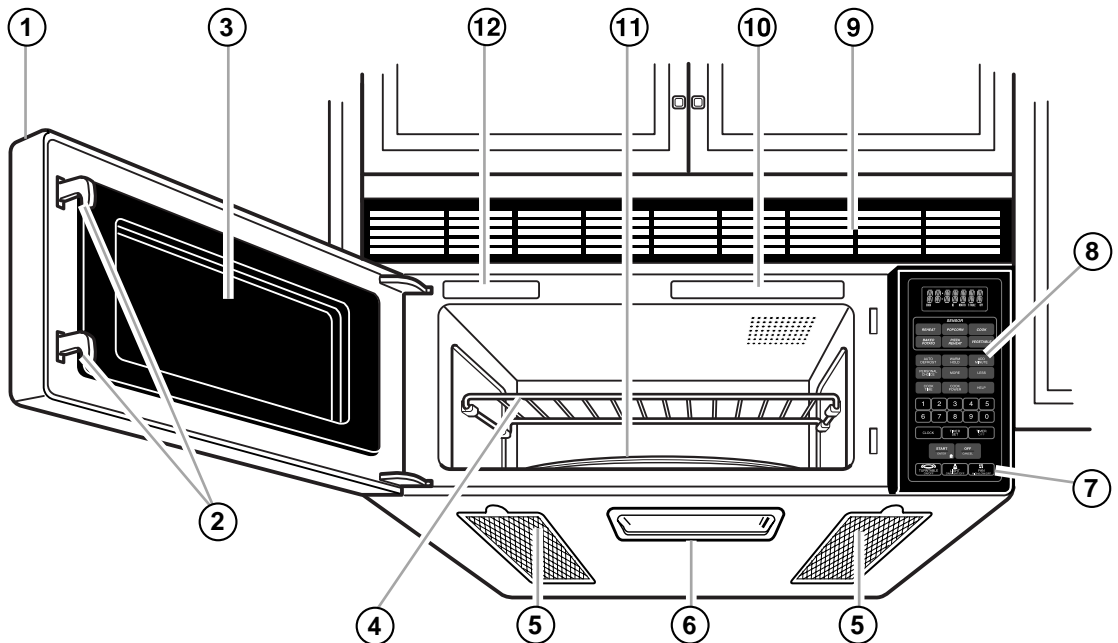

Your microwave oven is designed to make your cooking experience as enjoyable and productive as possible. To get you up and running quickly, the following is a list of the oven's basic features:

1. **Door Handle.** Pull to open door.
2. **Door Safety Lock System.** The oven will not operate unless the door is securely closed.
3. **Window with Metal Shield.** The shield prevents microwaves from escaping. It is designed as a screen to allow you to view food as it cooks.
4. **Two-Position Bi-Level Cooking Rack.** Use for extra space when cooking in more than one container at the same time.
5. **Filter.** See "Caring for the filters" section.
6. **Cooktop/Countertop Light.** Turn on to light your cooktop or countertop or to use as a night light.

7. **Turntable, Fan, and Cooktop Light Switches.**

8. **Control Panel.** Touch the pads on this panel to perform all functions.

9. **Vent Grille.**

10. **Cooking Guide.** Use as a quick reference for Auto Defrost and Sensor Cook settings.

11. **Glass Turntable.** The turntable turns food as it cooks for more even cooking. It must be in the oven during operation for best cooking results.

12. **Model and Serial Number Plate.**

Control panel features

Your microwave oven control panel lets you select the desired cooking function quickly and easily. All you have to do is touch the necessary Command Pad. The following is a list of all the Command and Number Pads located on the control panel. For more information on these features, see “Microwave Oven Use” section.

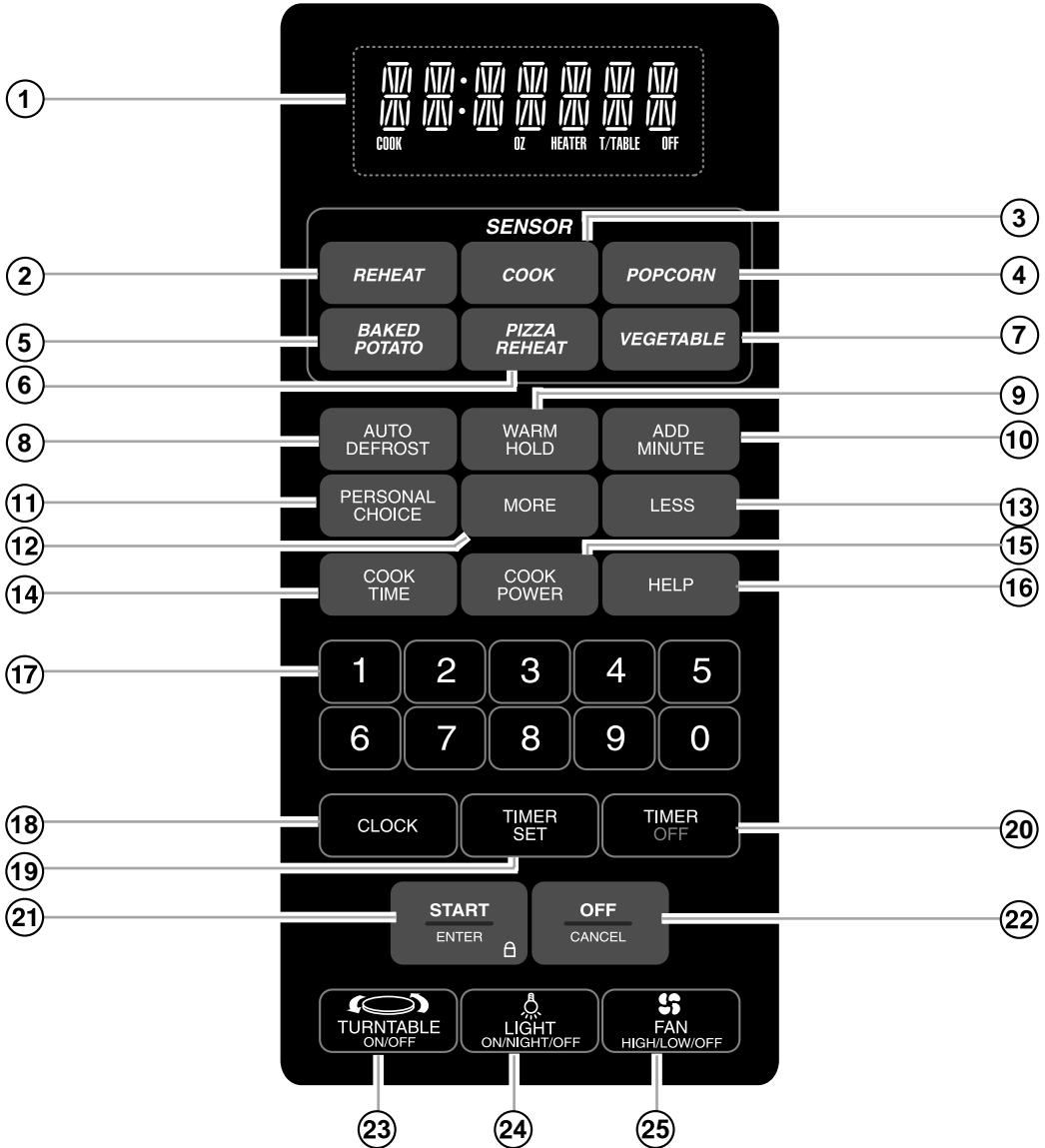

1. DISPLAY. The display includes a clock and indicators to tell you time of day, cooking time settings, cook powers, quantities, weights and cooking functions selected.

2. REHEAT. Touch this pad to reheat food with the SENSOR feature.

3. COOK. Touch this pad to cook common microwave-prepared foods with the SENSOR feature.

GETTING TO KNOW YOUR MICROWAVE OVEN

4. **POPCORN.** Touch this pad to pop popcorn with the SENSOR feature.
 5. **BAKED POTATO.** Touch this pad to cook potatoes with the SENSOR feature.
 6. **PIZZA REHEAT.** Touch this pad to reheat one or several slices of pizza with the SENSOR feature.
 7. **VEGETABLE.** Touch this pad to cook vegetables with the SENSOR feature.
 8. **AUTO DEFROST.** Touch this pad followed by Number Pads to thaw frozen meat by weight.
 9. **WARM HOLD.** Touch this pad to keep hot, cooked foods warm in your oven. WARM HOLD can be used by itself, or it can automatically follow a cooking cycle.
 10. **ADD MINUTE.** Touch this pad to cook for 1 minute, at 100% cook power, or to add an extra minute, at the set cook power to your cooking cycle.
 11. **PERSONAL CHOICE.** Touch this pad to change the pre-set operation of the tones, clock, display speed, defrost weight and demo features.
 12. **MORE.** Touch this pad to add 10 seconds of cook time each time you press it.
 13. **LESS.** Touch this pad to subtract 10 seconds of cook time each time you press it.
 14. **COOK TIME.** Touch this pad followed by Number Pads to set a cooking time.
 15. **COOK POWER.** Touch this pad after the cook time has been set, followed by a Number Pad to set the amount of microwave energy released to cook the food. The higher the number, the higher the microwave power or “cooking speed.”
 16. **HELP.** Touch this pad to learn how to use each oven function.
 17. **Number Pads.** Touch Number Pads to enter cooking times, cook powers, quantities, weights, or food categories.
 18. **CLOCK.** Touch this pad to enter the correct time of day.
 19. **TIMER SET.** Touch this pad to set the Minute Timer.
 20. **TIMER OFF.** Touch this pad to cancel the Minute Timer.
 21. **START/ENTER.** Touch this pad to start a function. If you open the door after the oven begins to cook, retouch START/ENTER.
 22. **OFF/CANCEL.** Touch this pad to erase an incorrect command, cancel a program during cooking, or to clear the Display.
 23. **TURNTABLE ON/OFF.** Touch this pad to stop the turntable only during the Warm Hold and cook time functions. Stop the turntable only if the dish you are using is too long to turn inside the oven.
To stop the turntable, touch TURNTABLE ON/OFF before or after touching START/ENTER. The word OFF will scroll across the display and T/TABLE OFF will appear during cooking. If you do not program a function within 1 minute of pressing TURNTABLE ON/OFF, the turntable will automatically turn back on.
To turn the turntable back on, touch TURNTABLE ON/OFF at any time during the programmed cycle.
 24. **LIGHT.** Touch this pad to turn on the cooktop/countertop light.
 25. **FAN.** Touch this pad to turn the fan on or off.
- NOTE:** If you try to enter incorrect instructions, you will not hear any tones. Touch CANCEL/OFF and re-enter the instructions.

Audible signals

Audible signals are available to guide you when setting and using your oven:

- A programming tone will sound each time you touch a pad.
- Seven tones signal the end of a Minute Timer countdown.
- Four tones signal the end of a cooking cycle.
- Three tones sound once every minute after an End-of-Cooking signal as a reminder if food has not been removed from oven.

Interrupting cooking

You can stop the oven during a cycle by opening the door. The oven stops heating and the fan stops, but the light stays on. To restart cooking, close the door and Touch START/ENTER.

If you do not want to continue cooking:

- Close the door and the light goes off.
- OR
- Touch OFF/CANCEL.

Microwave Oven Use

This section gives you instructions for operating each function. Please read these instructions carefully.

Using the safety lock

The safety lock prevents unwanted use of the microwave oven by disabling the control panel Command Pads.

To lock or deactivate the control panel:

Touch and hold START/ENTER for 4 seconds. Two tones will sound and LOCKED will appear on the display.

To cancel the safety lock:

Touch and hold START/ENTER for 4 seconds. Two tones will sound and LOCKED will be cleared from the display.

Using the HELP feature

Touch the HELP keypad to display feature information and useful hints.

1. Touch HELP.

TOUCH THIS KEYPAD THEN THE DESIRED FEATURE scrolls across display.

2. Touch a function keypad.

(Example: POPCORN)

TOUCH THIS KEYPAD TO POP MICROWAVE POPCORN

THE DISPLAY WILL SHOW SENSING UNTIL THE REMAINING COOK TIME HAS BEEN CALCULATED scrolls across display.

Using the fan

The Fan pad on the bottom right of the control panel controls the 2-speed Fan.

1. Touch FAN

(once for High, twice for Low)

NOTE: If the temperature gets too hot around the microwave oven, the fan in the vent hood will automatically turn on at the LOW setting to protect the oven. It may stay on up to an hour to cool the oven. When this occurs, the FAN pad will not turn the fan off.

2. Turn off fan when desired.

Touch FAN

(twice if on HIGH, once if on LOW)

Using the cooktop/countertop light

The pad on the bottom center of the control panel controls the cooktop/countertop light.

1. Touch LIGHT.

(once for high, twice for low [night light])

2. Turn off light when desired.

Touch LIGHT.

(twice if on high, once if on low)

Using the bi-level cooking rack

The Bi-Level Cooking Rack gives you extra space when cooking in more than one container at the same time. The metal rack can be turned upside-down to help fit taller containers on the bottom of the oven.

If you need a replacement rack, you can order one from your Whirlpool designated service company, or by calling the Customer Interaction Center at 1-800-253-1301. Make sure to have your model number when ordering.

Inserting the rack

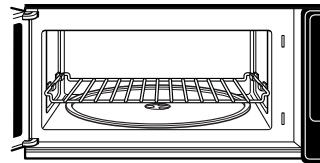

First position: Insert the rack securely into the rack supports on the side walls of the oven.

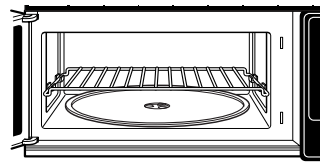

Second position: Turn rack upside-down when using a taller container on the bottom of the oven.

NOTES:

- Rack will become hot. Always use oven mitts or pot holders when handling.
- Do not allow the rack to touch the inside cavity walls, ceiling or floor.
- Do not use metal cookware, utensils, or a browning dish with the rack.
- Do not let food container on rack touch the top or sides of the oven.
- Do not place popcorn bags on rack.
- The rack is designed specifically for this oven. Do not use it in any other oven.

- Do not cook food directly on the rack. Always use a microwave-safe container.
- Use the rack only when cooking on two levels. Do not store it in the oven. Damage to the oven could result if someone accidentally turns on the oven.

Setting the clock

When your microwave oven is first plugged in or after a power failure, the Display will show "PLEASE TOUCH TIME OF DAY." If a time of day is not set, ":" will show on the Display until you touch CLOCK.

NOTES:

- If you enter in an incorrect time and touch CLOCK, you cannot set time of day. Enter the correct time.
- If you touch OFF/CANCEL while setting the clock, the Display will show the last time of day set or ":" if no time of day has been set.

To set time:

1. Touch CLOCK.

(once for a.m., twice for p.m.)

2. Enter time of day.

Example for 3:25: Touch "3 2 5." Then touch CLOCK or START/ENTER.

Using the Minute Timer

You can use your microwave oven as a minute timer. Use the Minute Timer for timing up to 99 minutes, 99 seconds.

NOTES:

- The oven can operate while the Minute Timer is in use. To see the Minute Timer while the oven is cooking, touch TIMER SET. The Display will return to the cooking time countdown while touching.

- To see the time of day while the timer is counting down, touch clock.
- If you want to use other command pads while the timer is counting down, touch TIMER OFF to cancel the Minute Timer.

1. Touch TIMER SET.

2. Enter time to be counted down.

Example for 3 minutes: Touch "3 0 0."

3. Touch START/ENTER

(display counts down set time)

At the end of countdown, "END" will be displayed and seven tones will sound. To restore time of day, touch OFF/CANCEL.

Cooking at high cook power

1. Put food in oven and close the door.

2. Touch COOK TIME

ENTER COOKING TIME scrolls across display.

Example for 1 minute, 30 seconds: Touch "1 3 0."

TOUCH START OR POWER scrolls across display.

3. Touch START/ENTER.

(display counts down cooking time)

At end of cooking time, "END" will be displayed and four tones will sound. The display will show the time of day after you open the door or touch OFF/CANCEL.

Cooking at different cook powers

For best results, some recipes call for different cook powers. The lower the cook power, the slower the cooking. Each number from 1 to 10 stands for a different percentage of cook power.

The following chart gives the percentage of cook power each number pad stands for, and the cook power name usually used.

It also tells you when to use each cook power. Follow recipe or food package instructions if available.

NOTE: Refer to a reliable cookbook for cooking times based on the 1000 Watt cook power of your microwave oven.

COOK POWER	NAME	WHEN TO USE IT
100% of full power (automatic)	High	<ul style="list-style-type: none"> ● Quick heating many convenience foods and foods with high water content, such as soups and beverages
9 = 90% of full power		<ul style="list-style-type: none"> ● Cooking small tender pieces of meat, ground meat, poultry pieces, and fish fillets and most vegetables ● Heating cream soups
8 = 80% of full power		<ul style="list-style-type: none"> ● Heating rice, pasta, or stirrable casseroles ● Cooking and heating foods that need a cook power lower than high (for example, whole fish and meat loaf)
7 = 70% of full power	Medium-High	<ul style="list-style-type: none"> ● Reheating a single serving of food
6 = 60% of full power		<ul style="list-style-type: none"> ● Cooking sensitive foods such as cheese and egg dishes, pudding, and custards ● Cooking non-stirrable casseroles, such as lasagna
5 = 50% of full power	Medium	<ul style="list-style-type: none"> ● Cooking ham, whole poultry, and pot roasts ● Simmering stews
4 = 40% of full power		<ul style="list-style-type: none"> ● Melting chocolate ● Heating pastries
3 = 30% of full power	Medium-Low, Defrost	<ul style="list-style-type: none"> ● Defrosting foods, such as bread, fish, meats, poultry, and precooked foods
2 = 20% of full power		<ul style="list-style-type: none"> ● Softening butter, cheese, and ice cream
1 = 10% of full power	Low	<ul style="list-style-type: none"> ● Keeping food warm ● Taking chill out of fruit

NOTE: Once cook time has been entered, you can also use the Cook Power pad as a second Minute Timer by entering "0" for the Cook Power. The oven will count down the cooking time you set without cooking.

Cooking at different cook powers (cont.)

1. Put food in oven and close the door.

2. Touch COOK TIME.

ENTER COOKING TIME scrolls across display.

Example for 7 minutes, 30 seconds:
Touch "7 3 0."

3. Touch COOK POWER.

ENTER POWER LEVEL 1 TO 10 scrolls across display.

Example for 50% cook power: Touch "5."

P-50 TOUCH START scrolls across display.

4. Touch START/ENTER.

(display counts down cooking time)

At end of cooking time, "END" will be displayed and four tones will sound. The display will show the time of day after you open the door or touch OFF/CANCEL.

Cooking with more than one cook cycle

For best results, some recipes call for one Cook Power for a certain length of time, and another Cook Power for another length of time. Your oven can be set to change from one to another automatically, for up to four cycles (including Auto Defrost and Warm Hold).

1. Put food in oven and close the door.

2. Set cooking time for first cycle.

Touch COOK TIME.

Example for 7 minutes, 30 seconds:
Touch "7 3 0."

3. Set cook power for first cycle.

Touch COOK POWER.

Example for 50% cook power: Touch "5."
P-50 TOUCH START scrolls across display.

4. Repeat Steps 2 and 3 to set the cook time and cook power for the second cycle.

5. Touch START/ENTER.

After the first cycle is over, 2 tones will sound and the next cycle(s) will count down.

At end of the cooking time, "END" will be displayed and four tones will sound. The display will show the time of day after you open the door or touch OFF/CANCEL.

Using AUTO DEFROST

You can defrost food by choosing a category and setting a weight. AUTO DEFROST has preset times and cook powers for 3 categories: Meat, Poultry, and Fish.

NOTES:

- To defrost items not listed in the “Auto defrost chart,” use 30% cook power. Refer to a reliable cookbook for defrosting information.
- During defrosting, the display will ask you to turn food over. After you do so, close the door and touch START to continue defrosting.

To use AUTO DEFROST, follow the steps below:

1. Touch AUTO DEFROST.

MEAT TOUCH 1, POULTRY TOUCH 2, FISH TOUCH 3, scrolls across display.

2. Touch Number pad for type of food.

ENTER WEIGHT scrolls across display.

3. Touch Number pad(s) to enter the weight.

(1=.1 lb, 11=1.1 lb, etc.)

4. START/ENTER.

At end of the defrosting time, “END” will be displayed and four tones will sound.

The display will show the time of day after you open the door or touch OFF/CANCEL.

This chart shows you how to choose a type of food and the weights you can set for each type. For best results, loosen or remove covering on food.

FOOD	TOUCH DEFROST, THEN TOUCH	WEIGHTS YOU CAN SET (tenths of a pound)
Meat	1	.1 to 6.0
Poultry	2	.1 to 6.0
Fish	3	.1 to 6.0

Weight conversion chart

You are probably used to food weights as being in pounds and ounces that are fractions of a pound (for example, 4 ounces equals ¼ pound). However, in order to enter food weight in AUTO DEFROST, you must specify pounds and tenths of a pound. If the weight on the food package is in fractions of a pound, you can use the following chart to convert the weight to decimals.

Equivalent Weight		
OUNCES	DECIMAL WEIGHT	
1.6	.10	
3.2	.20	
4.0	.25	One-Quarter Pound
4.8	.30	
6.4	.40	
8.0	.50	One-Half Pound
9.6	.60	
11.2	.70	
12.0	.75	Three-Quarters Pound
12.8	.80	
14.4	.90	
16.0	1.00	One Pound

Defrosting tips

- When using AUTO DEFROST, the weight to be entered is the net weight in pounds and tenths of pounds (the weight of the food minus the container).
- Before starting, make sure you have removed any of the metal twist-ties which often come with frozen food bags, and replace them with strings or elastic bands.
- Open containers such as cartons before they are placed in the oven.
- Always slit or pierce plastic pouches or packaging.
- If food is foil wrapped, remove foil and place it in a suitable container.
- Slit the skins, if any, of frozen food such as sausage.
- Bend plastic pouches of food to ensure even defrosting.
- Always underestimate defrosting time. If defrosted food is still icy in the center, return it to the microwave oven for more defrosting.
- The length of defrosting time varies according to how solidly the food is frozen.
- The shape of the package affects how quickly food will defrost. Shallow packages will defrost more quickly than a deep block.
- As food begins to defrost, separate the pieces. Separated pieces defrost more easily.
- Use small pieces of aluminum foil to shield parts of food such as chicken wings, leg tips, fish tails, or areas that start to get warm. Make sure the foil does not touch the sides, top, or bottom of the oven. The foil can damage the oven lining.
- For better results, let food stand after defrosting. (For more information on standing time, see “Microwave cooking tips” in the “Cooking Guide” section.)
- Turn over food during defrosting or standing time. Break apart and remove food as required.

Using WARM HOLD

WARNING

Food Poisoning Hazard

Do not let food sit in oven more than one hour before or after cooking.

Doing so can result in food poisoning or sickness.

Hot cooked food can be kept warm in the microwave oven. Warm Hold can be used by itself or after an automatic cooking cycle. Opening the door before the cycle ends will cancel the function.

1. Put hot, cooked food in oven and close the door.

2. Touch WARM HOLD.

WARM HOLD TOUCH START scrolls across display.

3. Touch START/ENTER.

At end of the warm hold, “END” will be displayed and four tones will sound.

The display will show the time of day after you open the door or touch OFF/CANCEL.

To make WARM HOLD automatically follow another cycle:

- While you are touching in cooking instructions, touch WARM HOLD before touching START/ENTER.
- When the last cooking cycle is over, you will hear two tones. “WARM” will come on while the oven continues to run.
- You can set WARM HOLD to follow AUTO DEFROST, COOK, or multi-cycle cooking.

Using WARM HOLD (cont.)

NOTES:

- Opening the oven door cancels WARM HOLD. Close the door and touch WARM HOLD, then touch START/ENTER if additional WARM HOLD time is desired.
- Food cooked covered should be covered during WARM HOLD.
- Pastry items (pies, turnovers, etc.) should be uncovered during WARM HOLD.
- Complete meals kept warm on a dinner plate should be covered during WARM HOLD.
- Do not use more than one complete WARM HOLD cycle. The quality of some foods will suffer with extended time.

Using PERSONAL CHOICE

You can change the preset values for tones, clock, display scrolling speed, defrost weight and demonstration features.

1. Touch PERSONAL CHOICE.

SOUND ON/OFF TOUCH 1,
CLOCK ON/OFF TOUCH 2,
SCROLL SPEED TOUCH 3,
LBS/KG CHOICE TOUCH 4,
DEMO ON/OFF TOUCH 5,
scrolls across display.

2. Touch function number.

Example for changing defrost weight:
Touch "4."

3. Follow display prompts.

Example for changing weight from lb. to kg.: Touch "2."

Sensor cooking guide

Sensor Cook allows you to cook many of your favorite foods without selecting cooking times and power levels. The display will show SENSING during the initial cook time. The oven automatically determines the required cooking time for each food item.

When the internal sensor detects a certain amount of humidity coming from the food, it tells the oven how much longer to heat. The display shows the remaining cook time. For best results from cooking by Sensor, follow these recommendations:

1. Turntable and outside of food container should be dry for best results.

2. Foods should always be covered loosely with microwavable plastic wrap, waxed paper, or a lid.

3. Do not open the door or touch OFF/CANCEL during the sensing times.

When sensing time is over, the oven beeps twice and the remaining cook times appears on the display. At this time, you can open the door to stir, turn or rearrange the food.

NOTES:

- Always use microwavable containers and cover them with lids or vented plastic wrap.
- Never use tight-sealing plastic covers. They can prevent steam from escaping and cause food to overcook.
- Match the amount to the size of the container. Fill containers at least half full for best results.
- Be sure the outside of the cooking container and the inside of the microwave oven are dry before placing food in the oven. Beads of moisture turning into steam can mislead the sensor.

Using SENSOR COOK

Using COOK lets you heat common microwave-prepared foods without needing to program times and Cook Powers. COOK has preset Cook Powers for 3 food categories: Number 1 for Frozen Entree, Number 2 for Casserole, or Number 3 for Rice.

1. Put food in oven and close the door.

2. Touch COOK.

SELECT MENU 1 TO 3 -- SEE COOKING GUIDE BEHIND DOOR scrolls across display.

Example for casserole: Touch "2."

Four seconds after you complete your selection, the oven will start.

When sensor detects a certain amount of humidity from food, cooking time is displayed. The display will show SENSING and the remaining cooking time.

At end of cooking time, "END" will be displayed and four tones will sound. The display will show the time of day after you open the door or touch OFF/CANCEL.

Using SENSOR REHEAT

REHEAT lets you heat foods without needing to program times and Cook Powers. REHEAT has preset Cook Powers for 3 categories: Number 1 for Casserole, Number 2 for Dinner Plate, or Number 3 for Soup/Sauce.

1. Put food in oven and close the door.

2. Touch REHEAT.

SELECT MENU 1 TO 3 -- SEE COOKING GUIDE BEHIND DOOR scrolls across display.

Example for reheating soup/sauce: Touch "3."

Four seconds after you complete your selection, the oven will start.

When sensor detects a certain amount of humidity from food, cooking time is displayed. The display will show SENSING and the remaining heating time.

At end of reheating time, "END" will be displayed and four tones will sound. The display will show the time of day after you open the door or touch OFF/CANCEL.

Using SENSOR BAKED POTATO

Cooking with BAKED POTATO lets you bake one or several potatoes by touching one pad.

NOTES:

- Before baking, pierce potato with fork several times. Do not cover.
- After baking, let stand for 5 minutes.

1. Put potato in oven and close the door.

2. Touch BAKED POTATO.

Four seconds later the oven will start.

When sensor detects a certain amount of humidity from potato, cooking time is displayed. The display will show SENSING and the remaining cooking time.

At end of cooking time, "END" will be displayed and four tones will sound. The display will show the time of day after you open the door or touch OFF/CANCEL.

Using SENSOR POPCORN

POPCORN lets you pop commercially packaged microwave popcorn by touching just one pad.

Pop only one package at a time. If you are using a microwave popcorn popper, follow manufacturer's instructions.

Cooking performance may vary with brand and fat content. Try several brands to decide which gives best popping results. For best results, use fresh bags of popcorn.

1. Place bag in oven and close the door.

2. Touch POPCORN.

Four seconds later, the oven will start.

When sensor detects a certain amount of humidity from popcorn, popping time is displayed. The display will show SENSING and the remaining cooking time.

At end of cooking time, "END" will be displayed and four tones will sound. The display will show the time of day after you open the door or touch OFF/CANCEL.

Using SENSOR PIZZA REHEAT

Reheating pizza with PIZZA REHEAT lets you reheat one or several slices of pizza by touching one pad.

1. Place pizza in oven and close door.

2. Touch PIZZA REHEAT.

Four seconds later the oven will start heating.

When sensor detects a certain amount of humidity from pizza, heating time is displayed.

At end of heating time, "END" will be displayed and four tones will sound. The display will show the time of day after you open the door or touch OFF/CANCEL.

Using SENSOR VEGETABLE

Cooking with VEGETABLE lets you heat common microwave-prepared vegetables without needing to program times and Cook Powers. VEGETABLE has preset cook powers for 3 food categories: Number 1 to select Fresh, Number 2 for Frozen, or Number 3 for Canned.

1. Place vegetables in oven and close door.

2. Touch VEGETABLE.

FRESH TOUCH 1, FROZEN TOUCH 2, CANNED TOUCH 3 scrolls across display.

Example for frozen vegetables: Touch “2.”

Four seconds after you complete your selection, the oven will start.

When sensor detects a certain amount of humidity from vegetables, cooking time is displayed. The display will show SENSING and the remaining cooking time.

At end of cooking time, “END” will be displayed and four tones will sound. The display will show the time of day after you open the door or touch OFF/CANCEL.

Using ADD MINUTE

ADD MINUTE lets you cook food for 1 minute at 100% Cook Power or add an extra minute to your cooking cycle. You can also use it to extend cooking time in multiples of 1 minute, up to 99 minutes.

NOTES:

- To extend cooking time in multiples of 1 minute, touch ADD MINUTE repeatedly during cooking.
 - You can enter ADD MINUTE only after closing the door, after touching OFF/CANCEL, or during cooking.
 - If you touch ADD MINUTE during cooking, the oven will cook at the currently selected Cook Power. If you touch ADD MINUTE after cooking is over, the oven will cook at 100% Cook Power.
 - You can only use ADD MINUTE with non-sensor functions.
-

1. Put food in oven and close door.

2. Touch ADD MINUTE.

Example for cooking for 3 minutes: Touch ADD MINUTE three times.

At end of cooking time, “END” will be displayed and four tones will sound. The display will show the time of day after you open the door or touch OFF/CANCEL.

Adding or subtracting cook time

If the Sensor function is too long or too short, you can increase or decrease the cook time by 10% after choosing the function. You can only increase or decrease cook time before cooking starts.

To increase cook time by 10%: Touch “9.”

To decrease cook time by 10%: Touch “7.”

To reset to the normal cook time: Touch “8.”

Cooking Guide

Microwave cooking tips

Amount of food

- If you increase or decrease the amount of food you prepare, the time it takes to cook that food will also change. For example, if you double a recipe, add a little more than half the original cooking time. Check for doneness and, if necessary, add more time in small increments.

Starting temperature of food

- The lower the temperature of the food being put into the microwave oven, the longer it takes to cook. Food at room temperature will be reheated more quickly than food at refrigerator temperature.

Composition of food

- Food with a lot of fat and sugar will be heated faster than food containing a lot of water. Fat and sugar will also reach a higher temperature than water in the cooking process.
- The more dense the food, the longer it takes to heat. “Very dense” food like meat takes longer to reheat than lighter, more porous food like sponge cakes.

Size and shape

- Smaller pieces of food will cook faster than larger pieces. Also, same-shaped pieces cook more evenly than different-shaped pieces.
- With foods that have different thicknesses, the thinner parts will cook faster than the thicker parts. Place the thinner parts of chicken wings and legs in the center of the dish.

Stirring, turning foods

- Stirring and turning foods spreads heat quickly to the center of the dish and avoids overcooking at the outer edges of the food.

Covering food

Cover food to:

- Reduce splattering

- Shorten cooking times
- Keep food moist

You can use any covering that lets microwaves pass through.

Releasing pressure in foods

- Several foods (for example: baked potatoes, sausages, egg yolks, and some fruits) are tightly covered by a skin or membrane. Steam can build up under the membrane during cooking, causing the food to burst. To relieve the pressure and to prevent bursting, pierce these foods before cooking with a fork, cocktail pick, or toothpick.

Using standing time

- Always allow food to stand after cooking. Standing time after defrosting and cooking allows the temperature to evenly spread throughout the food, improving the cooking results.
- The length of the standing time depends on how much food you are cooking and how dense it is. Sometimes it can be as short as the time it takes you to remove the food from the oven and take it to the serving table. However, with larger, denser food, the standing time may be as long as 10 minutes.

Arranging food

For best results, place food evenly on the plate. You can do this in several ways:

- If you are cooking several items of the same food, such as baked potatoes, place them in a ring pattern for uniform cooking.
- When cooking foods of uneven shapes or thickness, such as chicken breasts, place the smaller or thinner area of the food toward the center of the dish where it will be heated last.
- Layer thin slices of meat on top of each other.
- When you cook or reheat whole fish, score the skin – this prevents cracking.
- Do not let food or a container touch the top or sides of the oven. This will prevent possible arcing.

Using aluminum foil

Metal containers should not be used in a microwave oven. There are, however, some exceptions. If you have purchased food which is prepackaged in an aluminum foil container, refer to the instructions on the package. When using aluminum foil containers, cooking times may be longer because microwaves will only penetrate the top of the food.

If you use aluminum containers without package instructions, follow these guidelines:

- Place the container in a glass bowl and add some water so that it covers the bottom of the container, not more than $\frac{1}{4}$ in. (6 mm) high. This ensures even heating of the container bottom.
- Always remove the lid to avoid damage to the oven.
- Use only undamaged containers.
- Do not use containers taller than $\frac{3}{4}$ in. (19 mm).
- Container must be at least half filled.
- To avoid arcing, there must be a minimum $\frac{1}{4}$ in. (6 mm) between the aluminum container and the walls of the oven and also between two aluminum containers.
- Always place the container on the turntable.
- Reheating food in aluminum foil containers usually takes up to double the time compared to reheating in plastic, glass, china, or paper containers. The time when food is ready will vary depending upon the type of container you use.
- Let food stand for 2 to 3 minutes after heating so that heat is spread evenly throughout container.

Cooking you should not do in your microwave oven

- Do not do canning of foods in the oven. Closed glass jars may explode, resulting in damage to the oven.
- Do not use the microwave oven to sterilize objects (baby bottles, etc.). It is difficult to keep the oven at the high temperature needed for sterilization.

Microwave Oven Care

To make sure your microwave oven looks good and works well for a long time, you should maintain it properly. For proper care, please follow these instructions carefully.

For interior surfaces: Wash often with warm, sudsy water and a sponge or soft cloth. Use only mild, nonabrasive soaps or a mild detergent. Be sure to keep the areas clean where the door and oven frame touch when closed. Wipe well with clean water. Over time, stains can occur on the surfaces as the result of food particles spattering during cooking. This is normal.

For stubborn soil, heat 1 cup (250 mL) of water for 2 to 5 minutes in oven. Steam will soften soil. Rinse with clean water and dry with soft, lint-free cloth. To get rid of odors inside the oven, heat 1 cup (250 mL) of water with 1 tablespoon (15 mL) of either lemon juice or vinegar for 2 to 5 minutes in oven.

For exterior surfaces and control panel: Use a soft cloth with spray glass cleaner. Apply the spray glass cleaner to the soft cloth; do not spray directly on the oven.

NOTE: Abrasive cleansers, steel-wool pads, gritty wash cloths, some paper towels, etc., can damage the control panel and the interior and exterior oven surfaces.

To clean turntable and turntable support, wash in mild, sudsy water; for heavily soiled areas use a mild cleanser and scouring sponge. The turntable and turntable support are dishwasher-safe.

Caring for the filters

The grease filters should be removed and cleaned often, at least once a month.

NOTE: If your microwave hood combination is installed to recirculate air, the charcoal filter (available from your designated service company, Part No. 4359416) should be installed. The charcoal filter cannot be cleaned and should be replaced every 6 to 12 months.

Grease filters:

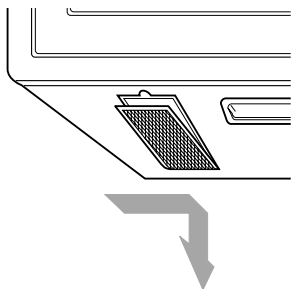

1. Unplug microwave oven or disconnect power.
2. To remove grease filters, slide each filter to the side. Pull filters downward and push to the other side. The filter will drop out.

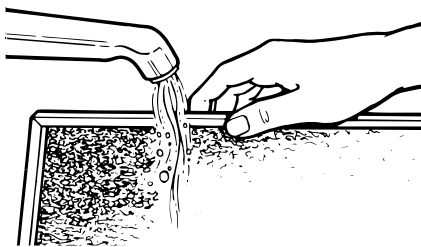

3. Soak grease filters in hot water and a mild detergent. Scrub and swish to remove embedded dirt and grease. Rinse well and shake to dry. Do not clean filters with ammonia, corrosive cleaning agents such as lye-based oven cleaners, or place them in a dishwasher. The filters will turn black or could be damaged.

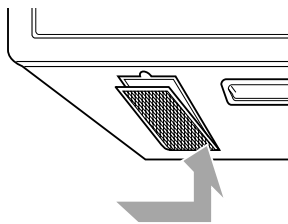

4. To replace grease filters, slide filter in the frame slot on one side of the opening. Push filter upward and push to the other side to lock into place.
5. Plug in microwave oven or reconnect power.

Charcoal filter:

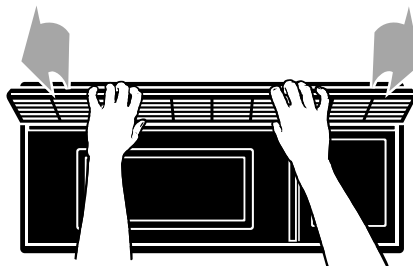

1. Unplug microwave oven or disconnect power.
2. Remove the vent grille mounting screws.
3. Tip the grille forward, then lift out to remove.

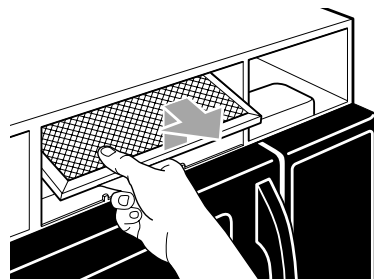

4. Lift the back of the charcoal filter. Slide the filter straight out.

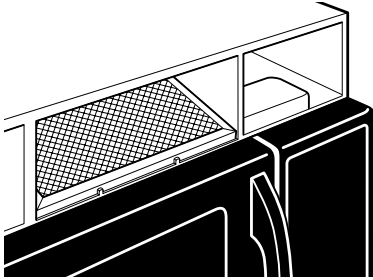

- Slide a new charcoal filter into place. The filter should rest at the angle shown.

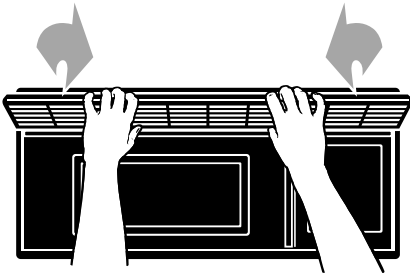

- Slide the bottom of the vent grille into place. Push the top until it snaps into place. Replace the mounting screws.
- Plug in microwave oven or reconnect power.

NOTE: Do not operate the hood without the grease filters in place.

Replacing the cooktop and oven lights

The cooktop light

- Unplug microwave oven or disconnect power.

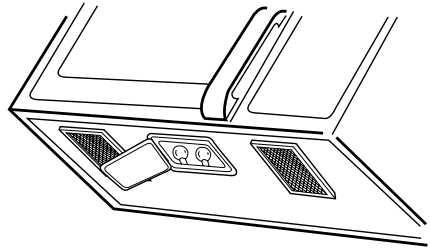

- Remove the bulb cover mounting screws.
- We recommend replacing bulb(s) with candelabra-base 30-watt bulb(s) available from your designated service company, or by calling the Customer Interaction Center at 1-800-253-1301. Make sure to have your model number when ordering.
- Plug in microwave oven or reconnect power.

The oven light

- Unplug microwave oven or disconnect power.

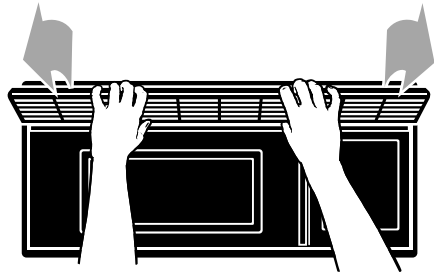

- Remove the vent grille mounting screws.
- Tip the grille forward, then lift out to remove.

MICROWAVE OVEN CARE

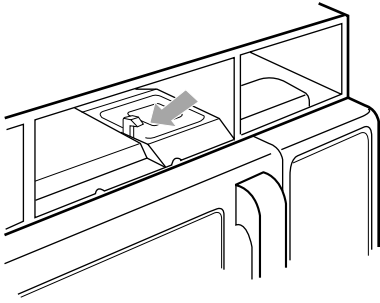

4. Lift up the bulb holder.

Bulb holder

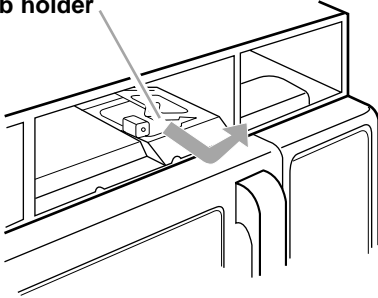

5. Replace the bulb.
6. We recommend replacing the bulb with a candelabra-base 30-watt bulb available from your designated service company, or by calling the Customer Interaction Center at 1-800-253-1301. Make sure to have your model number when ordering.
7. Replace the bulb holder, if damaged.

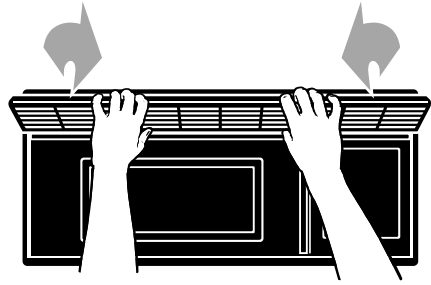

8. Slide the top of the vent grille into place. Push the bottom until it snaps into place. Replace the mounting screws.
9. Plug in microwave oven or reconnect power.

Questions and Answers

QUESTIONS	ANSWERS
Can I operate my microwave oven without the turntable or turn the turntable over to hold a large dish?	No. If you remove or turn over the turntable, you will get poor cooking results. Dishes used in your oven must fit on the turntable.
Can I use a rack in my microwave oven so that I may reheat or cook on two levels at a time?	You can use a rack only if the rack is supplied with your microwave oven. If you use a rack not supplied with the microwave oven, you can get poor cooking performance and/or arcing.
Can I use either metal or aluminum pans in my microwave oven?	You can use aluminum foil for shielding (use small, flat pieces), small skewers, and shallow foil trays (if tray is not taller than $\frac{3}{4}$ in. [19 mm] deep and half filled with food to absorb microwave energy). Never allow metal to touch walls or door.
Is it normal for the turntable to turn in either direction?	Yes. The turntable rotates clockwise or counterclockwise, depending on the rotation of the motor when the cooking cycle begins.
Sometimes the door of my microwave oven appears wavy. Is this normal?	This appearance is normal and does not affect the operation of your oven.
What are the humming noises that I hear when my microwave oven is operating?	You may hear the sound of the transformer when the magnetron tube cycles on.
Why does the dish become hot when I microwave food in it? I thought that this should not happen.	As the food becomes hot it will conduct the heat to the dish. Be prepared to use hot pads to remove food after cooking.
What does “standing time” mean?	“Standing time” means that food should be removed from the oven and covered for additional time to allow it to finish cooking. This frees the oven for other cooking.
Why does steam come out of the air exhaust vent?	Steam is normally produced during cooking. The microwave oven has been designed to vent this steam out the vents.
Can I pop popcorn in my microwave oven? How do I get the best results?	Yes. Pop packaged microwave popcorn following manufacturer’s guidelines or use the preset POPCORN pad. Do not use regular paper bags. Use the “listening test” by stopping the oven as soon as the popping slows to a “pop” every 1 or 2 seconds. Do not repop unpopped kernels. Do not pop popcorn in glass cookware.

Troubleshooting

Most cooking problems often are caused by little things you can find and fix without tools of any kind. Check the lists below before calling for assistance or service. If you still need help, see the “Requesting Assistance or Service” section.

If microwave does not operate, first check the following:

- Is the microwave oven plugged into a grounded 3 prong outlet?
- Have you blown a household fuse or tripped a circuit breaker?
- Has the electric company experienced a power failure?

Other possible problems and their causes:

Problem	Cause
The microwave oven will not run.	<ul style="list-style-type: none">● The door is not firmly closed and latched.● You did not touch START/ENTER.● You did not follow directions exactly.● An operation that was programmed earlier is still running.● You have not entered numbers after touching COOK TIME.
Microwave cooking times seem too long.	<ul style="list-style-type: none">● The electric supply to your home or wall outlets is low or lower than normal. Your electric company can tell you if the line voltage is low. Your electrician or service technician can tell you if the outlet voltage is low.● The cook power is not at the recommended setting.● Larger amounts of food need longer cooking times.
The turntable will not turn.	<ul style="list-style-type: none">● The turntable is not correctly in place. Make sure the turntable is correct-side up and is sitting securely on center shaft.● The support is not operating correctly. Remove turntable, check that the turntable support is properly in place, and restart oven. If turntable support does not move, call a designated service technician for repair. Cooking without the turntable can give you poor results.
The display shows a time counting down but the oven is not cooking.	<ul style="list-style-type: none">● The oven door is not closed completely.● You have set the controls as a kitchen timer. Touch OFF/CANCEL to cancel the Minute Timer.
You do not hear the Programming Tone.	<ul style="list-style-type: none">● The command is not correct.
The fan seems to be running slower than usual.	<ul style="list-style-type: none">● The oven has been stored in a cold area. The fan will run slower until the oven warms up to normal room temperature.
The display is showing “:”.	<ul style="list-style-type: none">● There has been a power interruption. Reset the clock.

If none of these items is causing your problem, see the “Assistance or Service” section.

Assistance or Service

To avoid unnecessary service calls, please check the “Troubleshooting” section. It may save you the cost of a service call. If you still need help, follow the instructions below.

If you need assistance or service

Call the Whirlpool Customer Interaction Center toll free at 1-800-253-1301. Our consultants are available to assist you.



When calling:

Please know the purchase date, and the complete model and serial number of your appliance (see the “A Note to You” section). This information will help us better respond to your request.

Our consultants provide assistance with:

- Features and specifications on our full line of appliances
- Installation information

- Use and maintenance procedures
- Accessory and repair parts sales
- Specialized customer assistance (Spanish speaking, hearing impaired, limited vision, etc.)
- Referrals to local dealers, service companies, and repair parts distributors

Whirlpool designated service technicians are trained to fulfill the product warranty and provide after-warranty service, anywhere in the United States.

To locate the Whirlpool designated service company in your area, you can also look in your telephone directory Yellow Pages.

For further assistance

If you need further assistance, you can write to Whirlpool with any questions or concerns at:

Whirlpool Brand Home Appliances
Customer Interaction Center
553 Benson Road
Benton Harbor, MI 49022-2692

Please include a daytime phone number in your correspondence.

WHIRLPOOL® Microwave Hood Combination Warranty

LENGTH OF WARRANTY	WHIRLPOOL CORPORATION WILL PAY FOR:
FULL ONE-YEAR WARRANTY FROM DATE OF PURCHASE	FSP® replacement parts and repair labor to correct defects in materials or workmanship. Service must be provided by a Whirlpool designated service company.
SECOND THROUGH FIFTH YEAR LIMITED WARRANTY	FSP® replacement magnetron tube on microwave hood combinations if defective in materials or workmanship.
WHIRLPOOL CORPORATION WILL NOT PAY FOR:	
<p>A. Service calls to:</p> <ol style="list-style-type: none"> 1. Correct the installation of your appliance. 2. Instruct you how to use your appliance. 3. Replace house fuses or correct house wiring. 4. Replace owner-accessible light bulbs and filters. <p>B. Repairs when your appliance is used in other than normal, single-family household use.</p> <p>C. Pickup and delivery. Your appliance is designed to be repaired in the home.</p> <p>D. Damage to your microwave oven resulting from accident, alteration, misuse, abuse, fire, flood, improper installation, acts of God or use of products not approved by Whirlpool Corporation.</p> <p>E. Repairs to parts or systems resulting from unauthorized modifications made to the appliance.</p> <p>F. Replacement parts or repair labor costs for units operated outside the United States.</p> <p>G. Any labor costs during limited warranty period.</p>	

10/01

WHIRLPOOL CORPORATION SHALL NOT BE LIABLE FOR INCIDENTAL OR CONSEQUENTIAL DAMAGES. Some states do not allow the exclusion or limitation of incidental or consequential damages, so this exclusion or limitation may not apply to you. This warranty gives you specific legal rights, and you may also have other rights which vary from state to state.

Outside the 50 United States, this warranty does not apply. Contact your authorized Whirlpool dealer to determine if another warranty applies.

If you need service, first see the “Troubleshooting” section of this book. After checking “Troubleshooting,” additional help can be found by checking the “Assistance or Service” section or by calling our Whirlpool Customer Interaction Center telephone number, 1-800-253-1301 (toll free), from anywhere in the U.S.A.