

West Bend™

MICROWAVE OVEN Instruction Manual



Important Safeguards.....	3
Setting Up Your Oven.....	7
Operation.....	9
Troubleshooting.....	20
One Year Limited Warranty.....	21

SAVE THIS INSTRUCTION MANUAL FOR FUTURE REFERENCE

PRECAUTIONS TO AVOID POSSIBLE EXPOSURE TO EXCESSIVE MICROWAVE ENERGY

- (a) Do not attempt to operate this oven with the door open as this can result in harmful exposure to microwave energy. It is important not to tamper with the safety interlocks.
- (b) Do not place any object between the oven front face and the door or allow soil or cleaner residue to accumulate on sealing surfaces.
- (c) Do not operate the oven if it is damaged. It is particularly important that the oven door closes properly and that there is no damage to the:
 - (1) DOOR (bent)
 - (2) HINGES AND LATCHES (broken or loosened)
 - (3) DOOR SEALS AND SEALING SURFACE
- (d) The oven should not be adjusted or repaired by anyone except properly qualified service personnel.

Specifications

Model:	AG028PLV
Rated Voltage:	120V~ 60Hz
Rated Input Power(Microwave):	1500W
Rated Output Power(Microwave):	1000W
Rated Input Power(Grill):	1150W
Rated Output Power(Grill):	1100W
Rated Input Power(Pizza):	1400W
Rated Output Power(Pizza):	1000W
Oven Capacity:	1.1 Cu.ft
Turntable Diameter:	Ø12.4 inch(315mm)
External Dimensions:	20.3×16.1×17.7 inch(516×408×450mm)
Net Weight:	Approx. 49.6Lbs(22.5Kg)

IMPORTANT SAFEGUARDS



CAUTION

WARNING

To reduce the risk of burns, electric shock, fire, injury to persons or exposure to excessive microwave oven energy when using your appliance, follow basic safety precautions, including the following:

- Read all instructions before using the appliance.
- Read and follow the specific: "PRECAUTIONS TO AVOID POSSIBLE EXPOSURE TO EXCESSIVE MICROWAVE ENERGY" found on page 2.
- As with most cooking appliances, close supervision is necessary to reduce the risk of a fire in the oven cavity.
- To reduce the risk of fire in the oven cavity:
 - i). Do not overcook food. Carefully attend the appliance when paper, plastic, or other combustible materials are placed inside the oven to facilitate cooking.
 - ii). Remove wire twist-ties and metal handles from paper or plastic containers/bags before placing them in the oven.
 - iii). If materials inside the oven ignite, keep the oven door closed. Turn the oven off, and unplug the appliance. Disconnect the power cord, shut off power at the fuse or circuit breaker panel.
 - iv). Do not use the oven cavity for storage purposes. Do not leave paper products, cooking utensils, or food in the cavity when not in use.
- This oven must be grounded. Connect only to properly grounded outlet. See "GROUNDING INSTRUCTIONS" found on page 4.
- Install or locate this oven only in accordance with the installation instructions provided.
- Some products such as whole eggs, sealed containers, or closed glass jars may explode and should not be heated in the oven.
- Use this appliance only for its intended uses as described in this manual. Do not use corrosive chemicals or vapors in this appliance. This oven is specifically designed to heat, cook or dry food. It is not designed for industrial or laboratory use.
- As with any appliance, close supervision is necessary when used by children.
- Do not operate this oven if it has a damaged cord or plug, if it is not working properly or if it has been damaged or dropped.
- This appliance should be serviced only by qualified service technicians.
- Contact the nearest authorized service facility for examination, repair or adjustment.
- Do not cover or block any openings on the oven.
- Do not store or use this appliance outdoors.
- Do not use this oven near water, for example, near a kitchen sink, in a wet basement, near a swimming pool, or similar locations.
- Do not immerse cord or plug in water.
- Keep cord away from heated surfaces.

- Do not let cord hang over edge of table or counter.
- When cleaning interior or exterior surfaces, used only mild, nonabrasive, soaps or detergents applied with a sponge or soft cloth.
- Liquids, such as water, coffee, or tea may overheat beyond the boiling point without appearing to be boiling. Visible bubbling or boiling when the container is removed from the microwave oven is not always present.

THIS COULD RESULT IN VERY HOT LIQUIDS SUDDENLY BOILING OVER WHEN THE CONTAINER IS DISTURBED, OR A SPOON OR OTHER UTENSIL IS INSERTED INTO THE LIQUID.

- i) Do not overheat the liquid.
- ii) Stir the liquid both before and halfway through heating it.
- iii) Do not use straight-sided containers with narrow necks.
- iv) After heating, allow the container to stand in the microwave oven for a short time before removing the container.
- v) Use extreme care when inserting a spoon or other utensil into the container.

GROUNDING INSTRUCTIONS

DANGER

Electric Shock Hazard

Touching some of the internal components can cause serious personal injury or death. Do not disassemble this appliance.

WARNING

Electric Shock Hazard

Improper use of the grounding can result in electric shock. Do not plug into an outlet until appliance is properly installed and grounded.

Three-pronged (grounding) plug

This appliance must be grounded. In the event of an electrical short circuit, grounding reduces the risk of electric shock by providing an escape wire for the electric current. This appliance is equipped with a cord having grounding wire with a grounding plug.

The plug must be plugged into an outlet that is properly installed and grounded.

Consult a qualified electrician or serviceman if the grounding instructions are not completely understood or if doubt exists as to whether the appliance is properly grounded. If it is necessary to use an extension cord, use only a 3-wire extension cord that has a 3-pronged grounding plug, and a 3-slot receptacle that will accept the plug on the appliance. The marked rating of the extension cord shall be equal to or greater than the electrical rating of the appliance.

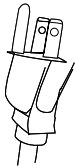

1. A short power-supply cord is provided to reduce the risks resulting from becoming entangled in or tripping over a longer cord.
2. Longer cord sets or extension cords are available and may be used if care is exercised in their use.
3. If a long cord set or extension cord is used:
 - 1) The marked electrical rating of the cord set or extension cord should be at least as great as the electrical rating of the appliance.
 - 2) The extension cord must be a grounding-type 3-wire cord
 - 3) The longer cord should be arranged so that it will not drape over the countertop or tabletop where it can be pulled on by children or tripped over unintentionally.

SAVE THESE INSTRUCTIONS

Radio Interference

1. Operation of the microwave oven may cause interference to your radio, TV, or similar equipment.
2. When there is interference, it may be reduced or eliminated by taking the following measures:
 - 1) Clean door and sealing surface of the oven
 - 2) Reorient the receiving antenna of radio or television.
 - 3) Relocate the microwave oven with respect to the receiver.
 - 4) Move the microwave oven away from the receiver.
 - 5) Plug the microwave oven into a different outlet so that microwave oven and receiver are on different branch circuits.

CONTAINERS

See the instructions on "Materials you can use in microwave oven or to be avoided in microwave oven." There may be certain non-metallic utensils that are not safe to use for microwaving. If in doubt, you can test the container in question following the procedure below. Container Test:

1. Fill a microwave-safe container with 1 cup of cold water (250ml) along with the container in question.
2. Cook on maximum power for 1 minute.
3. Carefully feel the container. If the empty container is warm, do not use it for microwave cooking.
4. Do not exceed 1 minute cooking time.

CAUTION

Personal Injury Hazard.

Tightly-closed containers could explode. Closed containers should be opened and plastic pouches should be pierced before cooking.

Materials you can use in microwave oven

Materials	Comments
Aluminum foil	Shielding only. Small smooth pieces can be used to cover thin parts of meat or poultry to prevent overcooking. Arcing can occur if foil is too close to oven walls. The foil should be at least 1 inch (2.5cm) away from oven walls.
Browning dish	Follow manufacturer's instructions. The bottom of browning dish must be at least 3/16 inch (5mm) above the turntable. Incorrect usage may cause the turntable to break.
Dinnerware	Microwave-safe only. Follow manufacturer's instructions. Do not use cracked or chipped dishes.
Glass jars	Always remove lid. Use only to heat food until just warm. Most glass jars are not heat resistant and may break.
Glassware	Heat-resistant oven glassware only. Make sure there is no metallic trim. Do not use cracked or chipped dishes.
Oven cooking bags	Follow manufacturer's instructions. Do not close with metal tie. Make slits to allow steam to escape.
Paper plates and cups	Use for short term cooking/warming only. Do not leave oven unattended while cooking.
Paper towels	Use to cover food for reheating and absorbing fat. Use with supervision for a short-term cooking only.
Parchment paper	Use as a cover to prevent splattering or a wrap for steaming.
Plastic	Microwave-safe only. Follow the manufacturer's instructions. Should be labeled "Microwave Safe". Some plastic containers soften as the food inside gets hot. "Boiling bags" and tightly closed plastic bags should be slit, pierced or vented as directed by package.
Plastic wrap	Microwave-safe only. Use to cover food during cooking to retain moisture. Do not allow plastic wrap to touch food.
Thermometers	Microwave-safe only (meat and candy thermometers).
Wax paper	Use as a cover to prevent splattering and retain moisture.

Materials to be avoided in microwave oven

Materials	Comments
Aluminum tray	May cause arcing. Transfer food into microwave-safe dish.
Food carton with metal handle	May cause arcing. Transfer food into microwave-safe dish.
Metal or metalrimmed utensils	Metal shields the food from microwave energy. Metal trim may cause arcing.
Metal twist ties	May cause arcing and could cause a fire in the oven.
Paper bags	May cause a fire in the oven.
Plastic foam	Plastic foam may melt or contaminate the liquid inside when exposed to high temperature.
Wood	Wood will dry out when used in the microwave oven and may split or crack.

SETTING UP YOUR OVEN

Names of Oven Parts and Accessories

Remove the oven and all materials from the carton and oven chamber.
Your oven comes with the following accessories:

Glass tray	1
Turntable ring assembly	1
Instruction Manual	1
Pizza Baking Tray	1
Grill rack	1

- A. Pizza Oven Door
- B. Pizza Baking Tray
- C. Door
- D. Control Panel
- E. Door Button

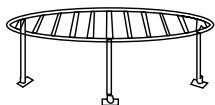
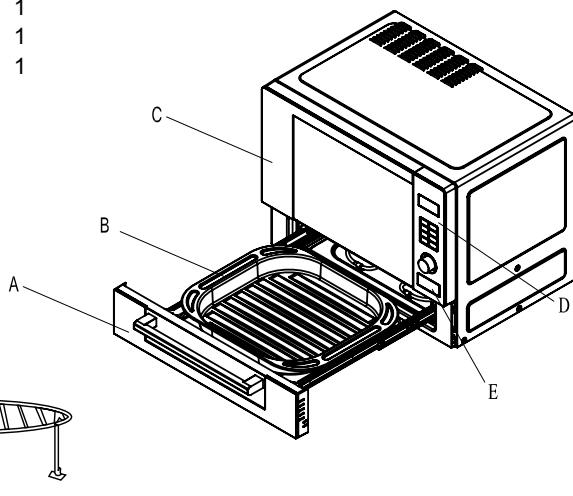

Grill Rack(Only for Grill series)

Turntable Installation

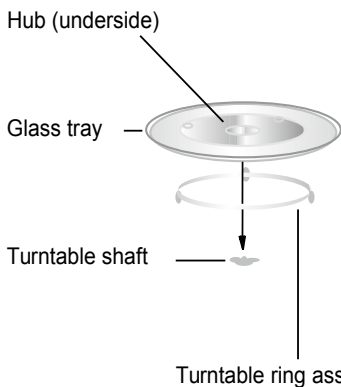

- a. Never place the glass tray upside down. The glass tray should never be restricted.
- b. Both glass tray and turntable ring assembly must always be used during cooking.
- c. All food and containers of food are always placed on the glass tray for cooking.

Before Installation

Remove all packing material and accessories. Examine the oven for any damage such as dents or broken door. Do not install if oven is damaged.

Cabinet: Remove any protective film found on the microwave oven cabinet surface.

Do not remove the light brown Mica cover that is attached to the oven cavity to protect the magnetron.

Installation

1. Select a level surface that provide enough open space for the intake and/or outlet vents.

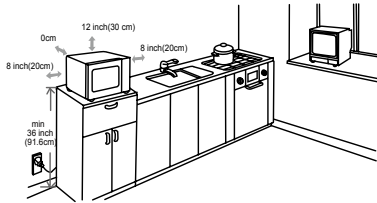

A minimum clearance of 8.0 inches(20cm) is required between the oven and any adjacent walls. One side must be open.

- (1) The minimum installation height is 36 inches (91.6cm); Leave a minimum clearance of 12 inches (30cm) above the oven.
- (2) Do not remove the legs from the bottom of the oven.
- (3) Blocking the intake and/or outlet openings can damage the oven.

- (4) Place the oven as far away from radios and TV as possible. Operation of microwave oven may cause interference to your radio or TV reception.

2. Plug your oven into a standard household outlet. Be sure the voltage and the frequency is the same as the voltage and the frequency on the rating label.

WARNING: Do not install oven over a range cooktop or other heat-producing appliance. If installed near or over a heat source, the oven could be damaged and the warranty would be void.

The accessible surface may be hot during operation.



OPERATION

Control Panel and Features

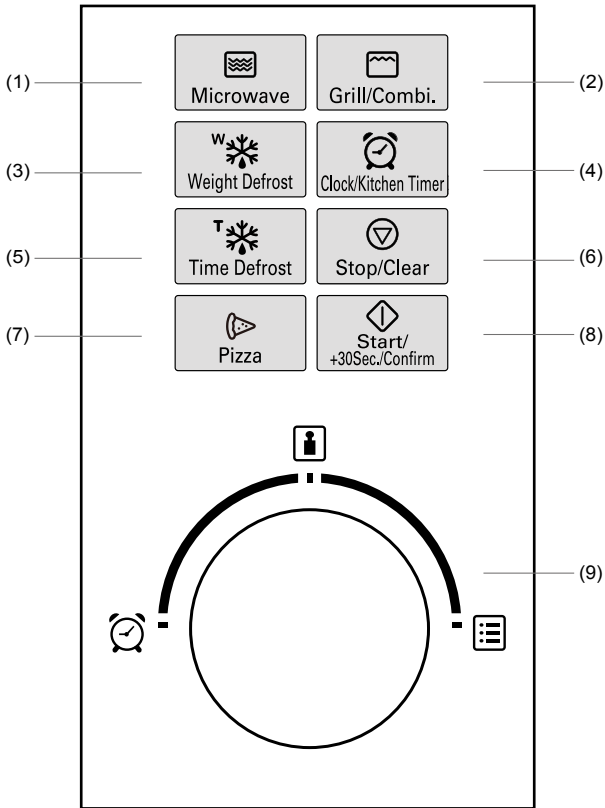

- (1) Microwave
- (2) Grill/Combi.
- (3) Weight Defrost
- (4) Clock/Kitchen Timer
- (5) Time Defrost
- (6) Stop/Clear
- (7) Pizza
- (8) Start/+30Sec./Confirm
- (9) Clock/Weight/Auto Menu Knob

OPERATION

1. Clock Setting

When the microwave oven is plugged in, the LED will display "0:00", buzzer will beep once.

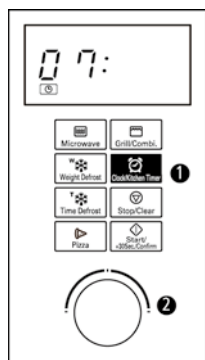

Press "**Clock/Kitchen Timer**" once to select clock function, the hour figures will flash, and "07:" will appear. Turn "0" to adjust the hour.

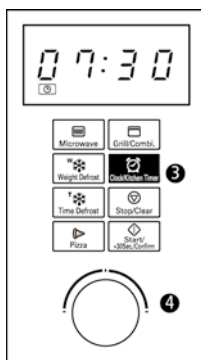

Press "**Clock/Kitchen Timer**", the minute figures will flash. Turn "0" to adjust the minutes.

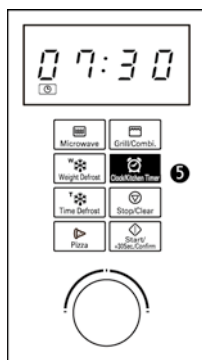

Press "**Clock/Kitchen Timer**" to finish clock setting.

Note: During the process of clock setting, if you press "**Stop/Clear**", the oven will go back to the previous time automatically.

2. Microwave Cooking

Press "**Microwave**" the LED will display "P100". Press "**Microwave**" or turn "0" to choose the power level you want. "P100", "P80", "P50", "P30" or "P10". Then press "**Start/+30Sec./Confirm**" to confirm, and turn "0" to set cooking time from 0:05 to 95:00. Press "**Start/+30Sec./Confirm**" again to start cooking.

Example: If you want to use 80% microwave power to cook for 20 minutes, you can operate the oven as the following steps.

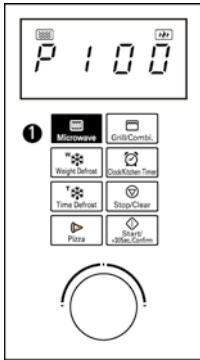

Press "**Microwave**" once, the screen display "P100".

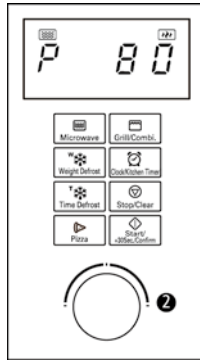

Press "**Microwave**" once again or turn "0" to choose 80% microwave power.

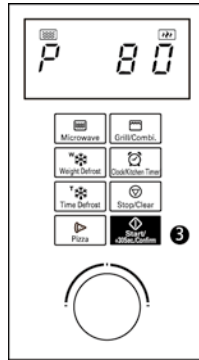

Press "**Start/+30Sec./Confirm**" to confirm, and the screen displays "P 80".

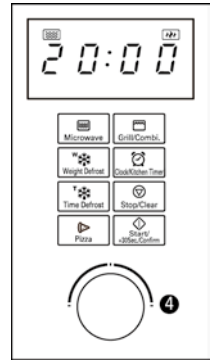

Turn "0" to adjust the cooking time until the oven displays "20:00".

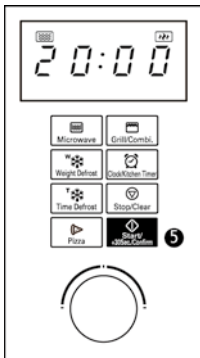

Press "**Start/+30Sec./Confirm**" to start cooking .

Power Levels

Display	=	Microwave Power
P100	=	100%
P80	=	80%
P50	=	50%
P30	=	30%
P10	=	10%

Time adjustments are in increments shown below.

Cook Time	Increments
0---1 min	5 seconds
1---5 min	10 seconds
5---10 min	30 seconds
10---30min	1 minute
30---95 min	5 minutes

3.Grill or Combi. Cooking

Press "Grill/Combi " the LED will display"G",and press "Grill/Combi" or turn the "◉" to choose the power you want, and "G","C-1" or "C-2" will display.Then press "Start/+30Sec./Confirm"to confirm, and turn "◉"to set cooking time from 0:05 to 95:00. Press "Start/+30Sec./Confirm" again to start cooking.

Example: If you want to use 55% microwave power and 45% grill power(C-1) to cook for 10 minutes, you can operate the oven as the following steps.

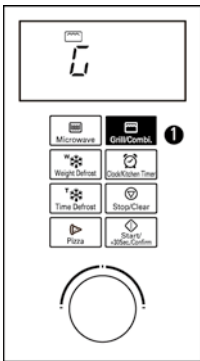

Press"Grill Combi" once, the screen display "G".

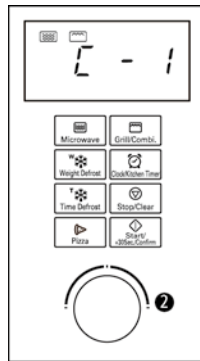

Press"Grill Combi" once again or turn "◉" to choose combi. 1 mode.

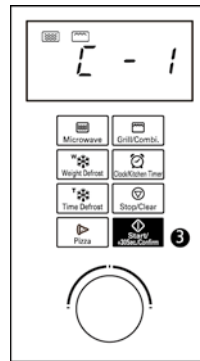

Press"Start/+30Sec./Confirm"to confirm, and the screen displays "C-1".

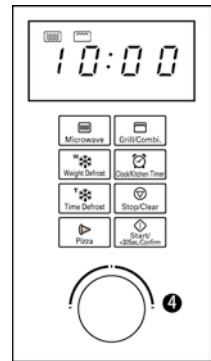

Turn "◉" to adjust the cooking time until the oven displays"10:00".

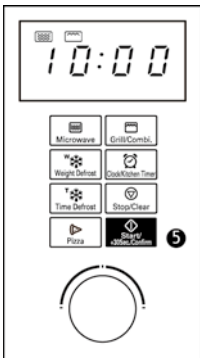

Press"Start/+30Sec./Confirm" to start cooking .

"Grill/Combi" Power levels

Number	Displays As	Microwave Power	Grill Power
1	G	0%	100%
2	C-1	55%	45%
3	C-2	36%	64%

Note:

There will be a beep when half the grill time has elapsed. For best results, turn the food over. Press"Start/+30 Sec./Confirm " to continue cooking.

Warning:

Only use the grill rack provided.Grill rack and glass tray will be hot.

4. Quick Start

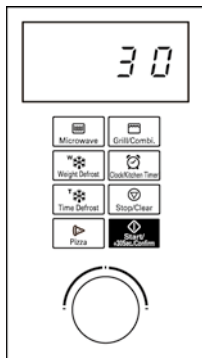

Press **"Start/+30Sec./Confirm"**. Oven will start cooking at 100% power for 30 seconds. Each added press will increase 30 seconds cooking time up to 95 minutes. **To cancel, press "Stop/Clear" twice.**

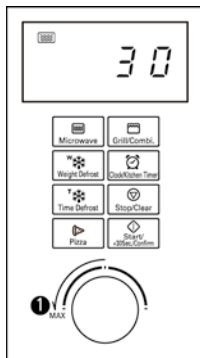

Or turn "**○**" left to set cooking time with 100% microwave power, then press **"Start/+30Sec./Confirm"** to start cooking.

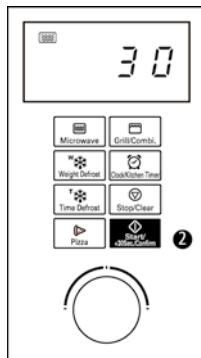

Microwave, Grill, Combi or Time Defrost, each press of **"Start/+30Sec./Confirm"** will increase 30 seconds of cooking time.

5. Defrost By Weight

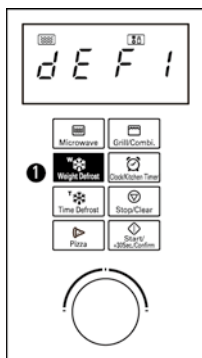

Press **"Weight Defrost"** once, the oven will display "dEF1".

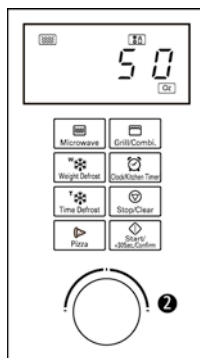

Turn "**○**" to select the weight of food from 4 to 100 Oz.

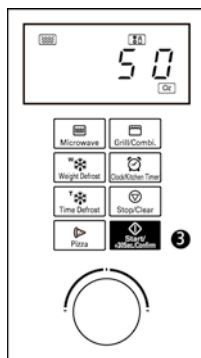

Press **"Start/+30Sec./Confirm"** to start defrosting.

6. Defrost By Time

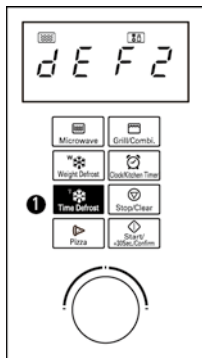

Press **"Time Defrost"** once, the oven will display "dEF2".

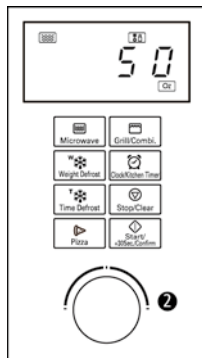

Turn "○" to select the defrost time. The MAX time is 95 minutes.

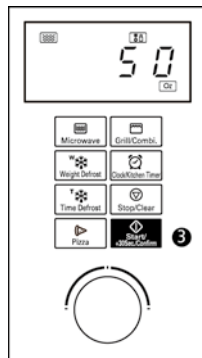

Press **"Start/30Sec./Confirm"** to start defrosting. The defrost power is P30, and it cannot be changed.

7. Kitchen Timer

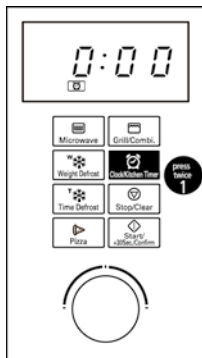

Press **"Clock/Kitchen Timer"** twice, LED will display 0:00, "Cl" will light.

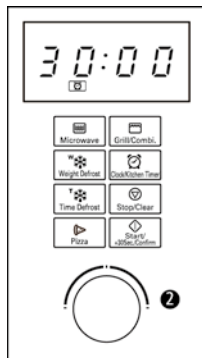

Turn "○" to enter the correct time. (The maximum cooking time is 95 minutes.)

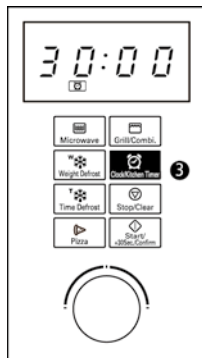

Press **"Clock/Kitchen Timer"** to confirm setting, "Cl" will flash.

Note: When the kitchen time is reached, "Cl" will go out. The buzzer will ring 5 times. If the clock is set, the LED will display the current time. The Kitchen Timer is different from the clock, Kitchen Timer is a timer.

8. Auto Menu

- 1) Turn "0" right to choose the menu, and "A-1" to "A-6" will display.
- 2) Press **"Start/+30Sec./Confirm"** to confirm.
- 3) Turn "0" to choose the default weight as the menu chart.
- 4) Press **"Start/+30Sec./Confirm"** to start cooking.

Example: If you want to use "Auto Menu" to cook 8.0 oz Frozen Vegetables.

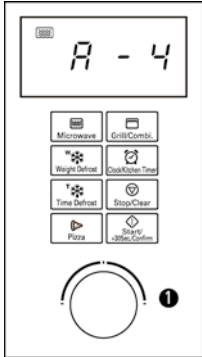

Turn "0" clockwise till "A-4" display.

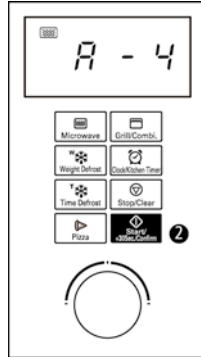

Press **"Start/+30Sec./Confirm"** to confirm.

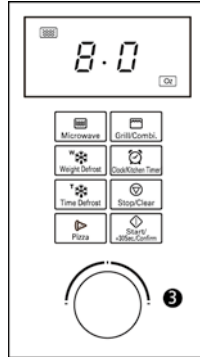

Turn "0" to select the weight until "8.0" is displayed.

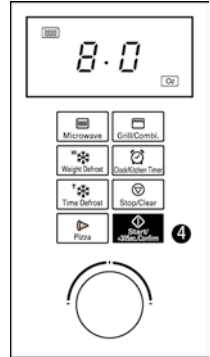

Press **"Start/30Sec./Confirm"** to start cooking.

The menu chart:

Auto Menu	Weight(Oz)	Display	Time
A-1 Popcorn	1.75	1.75	1:30
	3.0	3.0	2:10
	3.5	3.5	2:20
A-2 Potato(8Oz/pc)	1pc	1	5:00
	2pcs	2	7:30
	3pcs	3	10:00
A-3 Pizza Reheat Only	4.0	4.0	0:40
	8.0	8.0	1:10
	14.0	14.0	2:00
A-4 Frozen Vegetable	4.0	4.0	3:20
	8.0	8.0	5:10
	16.0	16.0	8:00
A-5 Beverage(120ml/cup)	1cup	1	1:00
	2cups	2	1:50
	3cups	3	2:40
A-6 Dinner Plate	9.0	9.0	2:40
	12.0	12.0	4:00
	18.0	18.0	6:30

9. Multi-Function Cooking

At most 2 functions can be set for cooking in multi-function cooking.

Note: If defrosting, it will automatically be placed as the first function.

Example: If you want to defrost food for 5 minutes and then cook with 80% microwave power for 7 minutes, operate it as the following:

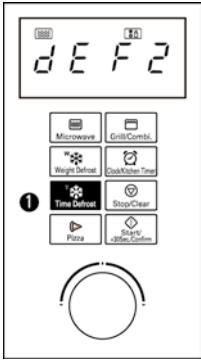

Press "Time Defrost" once, and the oven will display "dEF2".

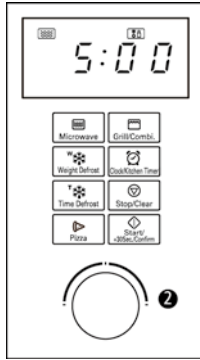

Turn "Start/30Sec Confirm" to select the defrost time till "5:00" display.

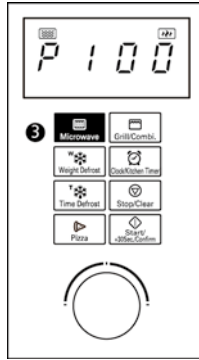

Press "Microwave" once, the screen display "P100".

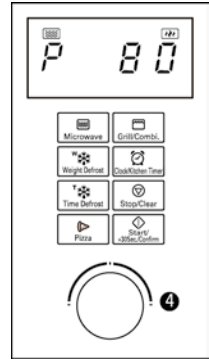

Press "Microwave" once again or turn "Start/30Sec Confirm" to choose 80% microwave power.

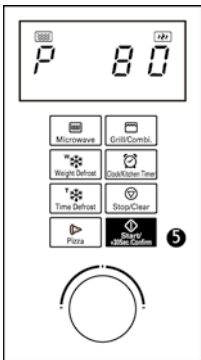

Press "Start/30Sec Confirm" to confirm, and the screen displays "P 80".

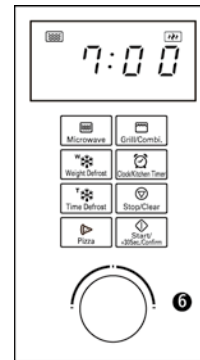

Turn "Start/30Sec Confirm" to adjust the cooking time till the oven displays "7:00".

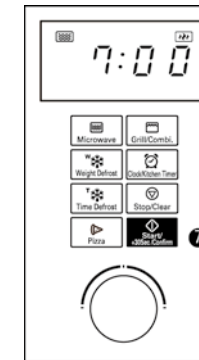

Press "Start/30Sec Confirm" to start cooking, and buzzer will sound once for the first section, defrosting time counts down; buzzer will sound once again entering the second cooking. When cooking has finished, buzzer will sound five times.

10. Pizza function

Open the pizza oven door, put the pizza on the baking tray, then close the door.

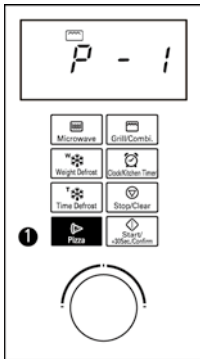

Press "Pizza" once, "P-1" will light and the oven display "P-1".

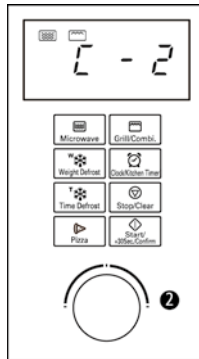

Press "Pizza" three times or turn "C" to select different menu, "C-1", "C-2", "C-3" or "P-1".

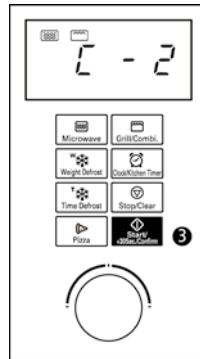

Press "Start+30Sec./Confirm" to confirm.

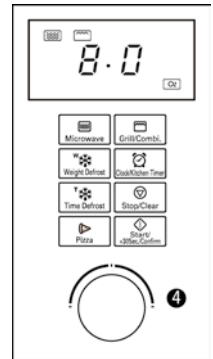

Turn "C" to choose the weight if "C-1" or "C-2" has been chosen; to choose diameter if P-1 has been chosen. Turn "C" to choose the cooking time if "C-3" has been chosen.

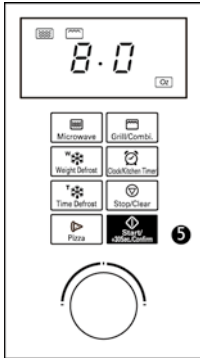

Press "Start+30Sec./Confirm", the oven will beep once and start cooking. The cooking time counts down.

Note:

During cooking, the remaining time can be increased by pressing "Start+30Sec./Confirm", the Max. cooking time is 95 minutes.

Menu chart:

Program/Display	Weight	The preset cooking time
Pizza/ P-1	8 inch	13:00mins
	9 inch	15:00mins
Chicken Wings/C-1	8 Oz	20:00mins
	16 Oz	25:00mins
Chicken Nuggets/C-2	8 Oz	20:00mins
	16 Oz	25:00mins
Custom time/C-3	Enter the time by "0"Max.cooking time is 95 minutes.	

Note: If door is opened,baking and timer stop.Press "Start/+30Sec./Confirm" to resume.

- 1) Pizza function can not work with the microwave or grill at the same time.
- 2) In programs C-1 and C-2,an alarm will sound at the half way point.Turn the food over for best results.
- 3) For a 12 inch pizza, use setting C-3 and enter desired cook time.

11. Inquiring Functions

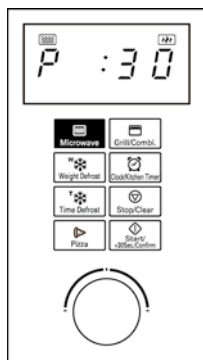

When microwave cooking, press "**Microwave**", the power level will be displayed for 3 seconds.

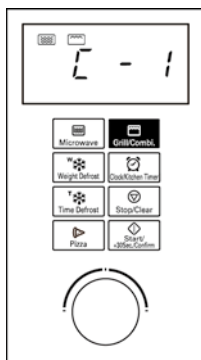

When grilling or combination cooking, press "**Grill/Combi**", the cooking mode will be displayed for 3 seconds.

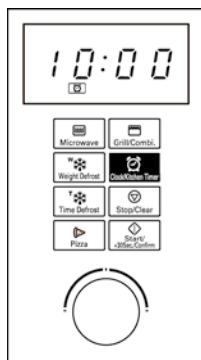

Press "**Start/+30Sec./Confirm**" to confirm.

12. Lock-out Function for Children

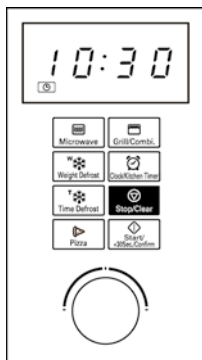

Lock: Press "**Stop/Clear**" for 3 seconds, there will be a long "beep" denoting entering the child-lock state . The lock icon will light.

Lock Cancel: Press "**Stop/Clear**" for 3 seconds, there will be a long "beep" denoting that the lock is released.

Troubleshooting

Check your problem by using the chart below and try the solutions for each problem. If the microwave oven still does not work properly, contact the nearest authorized service center.

TROUBLE	POSSIBLE CAUSE	POSSIBLE REMEDY
Oven will not start	<ul style="list-style-type: none"> a. Electrical cord for oven is not plugged in. b. Door is open. c. Wrong operation is set or not confirmed. 	<ul style="list-style-type: none"> a. Plug into the outlet. b. Close the door and try again. c. Press "Start/+30Sec./Confirm" or check instructions.
Arcing or sparking	<ul style="list-style-type: none"> a. Materials to be avoided in microwave oven were used. b. The oven is operated when empty. c. Spilled food remains in the cavity. 	<ul style="list-style-type: none"> a. Use microwave-safe cookware only. b. Do not operate with oven empty. c. Clean cavity with wet towel.
Unevenly cooked foods	<ul style="list-style-type: none"> a. Materials to be avoided in microwave oven were used. b. Food is not defrosted completely. c. Cooking time, power level is not suitable. d. Food is not turned or stirred. 	<ul style="list-style-type: none"> a. Use microwave-safe cookware only. b. Completely defrost food. c. Use correct cooking time, power level. d. Turn or stir food.
Overcooked foods	Cooking time, power level is not suitable.	Use correct cooking time, power level.
Undercooked foods	<ul style="list-style-type: none"> a. Materials to be avoided in microwave oven were used. b. Food is not defrosted completely. c. Oven ventilation ports are restricted. d. Cooking time, power level is not suitable. 	<ul style="list-style-type: none"> a. Use microwave-safe cookware only. b. Completely defrost food. c. Check to see that oven ventilation ports are not restricted. d. Use correct cooking time, power level.
Improper defrosting	<ul style="list-style-type: none"> a. Materials to be avoided in microwave oven were used. b. Cooking time, power level is not suitable. c. Food is not turned or stirred. 	<ul style="list-style-type: none"> a. Use microwave-safe cookware only. b. Use correct cooking time, power level. c. Turn or stir food.

ONE YEAR LIMITED WARRANTY

This product carries a warranty that it will be free from defects in material and workmanship for a period of one year from the date of purchase. This warranty is valid for the original retail purchaser from the date of initial retail purchase and is not transferable. Keep your original sales receipt.

IMPORTANT: This warranty does not cover damages resulting from accident, misuse or abuse, lack of reasonable care, the affixing of any attachments not provided with the product, loss of parts, or subjecting the appliance to any but the specified voltage. (Read directions carefully.)

If service is required during the warranty period, properly pack your unit. We recommend using the original carton and packing materials. Please call our customer service number below to get the exact shipping address before sending out the unit.

800-842-1289
Midea America Corp
4 Campus drive 1st floor South
Parsippany NJ 07054

Midea America Corp expressly disclaims all responsibility for consequential damages or incidental losses caused by use of the appliance. Some states do not allow this exclusion or limitation of incidental or consequential losses so the foregoing disclaimer may not apply to you. This warranty gives you specific legal rights, and you may also have other rights which may vary from state to state.

The serial number can be found on the back cabinet. We suggest that you record the serial number of your unit in the space below for future reference.

Model Number: _____

Serial Number: _____

SAVE THIS MANUAL AND YOUR ORIGINAL RECEIPT FOR YOUR RECORDS

West Bend™

Made in China
PN: 261800313062