

Microwave SMW 800 A1

61

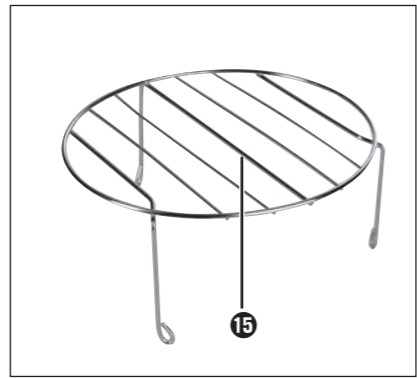

- Ⓜ **Microwave**
- Ⓜ **Operating instructions**



INDEX

PAGE

Intended Usage	2
Safety instructions	2
Items supplied	5
Technical Data	5
Before you begin	6
Basic principles of microwave cookery	6
Use suitable cookware	6
Description of the appliance	7
Commissioning	7
Installation of the appliance	7
Preparing the appliance	7
Inserting accessories	8
Operation	8
Setting the Clock	8
Setting the kitchen timer	8
Child protection system	9
Query functions	9
Heating and cooking	9
Microwave operation	9
Grill operation	10
Combination cooking processes	10
Auto menu	11
Starting the Auto-menu	11
Programmes in detail	12
Defrosting	14
Presetting the start time	14
Cleaning and Care	15
Troubleshooting	15
Disposal	16
Warranty and Service	16
Importer	16

Read these operating instructions carefully before using the appliance for the first time and preserve this booklet for later reference. Pass this booklet on to whoever might acquire the appliance at a future date.

MICROWAVE

Intended Usage

This appliance is intended for the heating up and preparation of foodstuffs according to the described procedures.

Any modifications to the appliance shall be deemed to be improper use and implies substantial risk of accidents. The manufacturer declines to accept responsibility for damage(s) arising out of usage contrary to the instructions specified below.

This appliance is not intended for commercial use.

Safety instructions

Important!

Warnings regarding damage to the appliance.

Danger! / **Risk of injury!**

Warning about physical injuries and electric shock!

Risk of fire!

Warning about risks of fire.

Notice!

Note – Hints and tips for using the microwave.

Safety precautions for the avoidance of excessive contact with microwave energy

- Do not try to operate the appliance while the door is open, as this can lead to you coming into contact with a potentially harmful dose of microwave radiation. It is also important not to break open or manipulate the safety locks .

- Do not jam anything between the front of the appliance and the door, and make sure that there is no residual food or cleaning agent on the seals.

Risk of injury!

- *If the door or the door seal is damaged, under no circumstances may you continue to use the appliance. Arrange for it to be repaired as soon as possible by qualified specialists.*
- *Never attempt to repair the appliance yourself. Removal of the appliance housing could cause the release of microwave energy. Arrange for the repair to be carried out only by qualified specialists.*
- *This appliance is not intended for use by individuals (including children) with restricted physical, physiological or intellectual abilities or deficiencies in experience and/or knowledge unless they are supervised by a person responsible for their safety or receive from this person instruction in how the appliance is to be used. Children should be supervised to ensure that they do not play with the appliance.*
- *Children may only be allowed to use the appliance without supervision if appropriate instructions have been given that have provided the child with the knowledge to use the cooker in a safe manner and to understand the risks of improper use.*
- *Only use this appliance for its intended purpose as described in this manual. Do not use any caustic chemicals or vapours in this appliance. This microwave oven is especially designed for heating, cooking, grilling, or drying foodstuffs. It is not intended for use in industrial applications or laboratories.*
- *Do not operate the microwave oven if the power cable or plug are damaged. To avoid injury, arrange for damaged power cables or plugs to be exchanged by qualified specialists before re-using the appliance.*
- *Keep children well away from the microwave oven when it is in use. Risk of Burns!*

- Under no circumstances should you remove the microwave oven housing.
- Should the lamp in the interior of the microwave oven need replacing, arrange for this to be done by a qualified specialist.
- Never touch the microwave oven door, housing, ventilation openings, accessories or the dinnerware directly after the grill, combi or automatic menu process. The parts will be very hot. Allow them to cool down before cleaning them.
- Ensure that the plug is at all times easily accessible, so that it can be quickly removed in the event of an emergency.
- People fitted with a heart pacemaker should consult their doctor about the possible risks of using a microwave oven before taking one into use.
- Do not allow the power cable to hang from a table or work surface. Children could pull on it.
- After they have been warmed up, always open containers, popcorn-bags etc. with the opening pointing away from your body. Escaping steam could lead to scalds.
- Never stand directly against the microwave oven when opening the door. Escaping steam could lead to scalds.
- Do not fry in the microwave. Hot oil can damage parts of the appliance and utensils and even cause skin burns.
- Always shake-up or stir warmed up baby glasses or bottles! The contents could have heated up unevenly and the baby could be burned/scalded by them. At all events, check their temperature before feeding them to the baby!
- Do not modify the microwave oven.
- Microwave radiation is dangerous! Maintenance and repairs requiring the removal of access covers, which are intended for protection against contact with microwave radiation, are to be carried out by trained specialists only.

- Before consumption, check the temperature, so as to avoid a potentially life-threatening scalding for babies.
Cooking utensils may become hot from the heat emitted by the food, so that you may require oven gloves to touch them. In this case, a check should also be made to ensure that the cooking utensils are suitable for use with the microwave oven.



Attention! Hot surfaces!



Risk of fire

- Never leave the microwave oven unattended if you are heating foodstuffs packed in plastics or paper.
- Never place flammable materials close to the microwave oven or the ventilation openings.
- Remove ALL metallic closures from the packaging of the foodstuff that you intend to warm up.
Risk of fire!
- When making popcorn, use only popcorn-bags suitable for microwave ovens.
- Do not use the microwave oven to warm up cushions filled with kernels, cherry stones or gels.
Risk of fire!
- Do not use the microwave oven for storing foodstuffs or other objects.
- Do not exceed the cooking times detailed by the manufacturer.
- Do not place any objects on the microwave oven when it is in use. The ventilation openings would be blocked!
- Do not place the microwave oven adjacent to other appliances discharging heat, for example, an oven.

- Clean the microwave oven thoroughly after warming up greasy foods, especially if they were not covered. Allow the appliance to cool down completely before cleaning it. Residues such as fat or grease cannot be allowed to collect on the heating elements of the grill. They could possibly ignite.
- Do not thaw frozen fat or oil in the microwave oven. The fat or oil could ignite.
- Do not use an external timing switch or a separate remote control system to operate the appliance.

⚠ Important! Appliance Damage!

- Do not use the microwave oven when it is empty. The only exception is for the initial commissioning (see chapter "Commissioning").
- Never insert foreign objects into the ventilation openings or the door safety locks.
- Do not use metallic utensils which reflect microwaves and lead to sparking. Do not place tins in the microwave oven.
- Do not place plastic containers in the microwave oven immediately after a grill, combi or automatic menu process. The plastic could melt.
- This microwave oven may not be located in areas with high humidity or where moisture could collect.
- Liquids and other foods must not be heated in airtight containers, as these may explode and damage the appliance.
- Do not lean on the microwave oven door.
- Insufficient cleanliness of the appliance could lead to the destruction of the upper surfaces, which themselves influence its useful lifespan and could possibly also lead to dangerous situations.

⚠ Danger

- Never submerge the appliance, the power cable or the plug in water or other fluids.
- Keep the power cable away from hot surfaces. Do not lead it in front of the microwave oven door. The heat could damage the cable.
- Never pour fluids into the ventilation openings or the safety locks. Should fluids ever enter them, immediately switch the microwave oven off and remove the plug from the mains power socket. Arrange for the appliance to be checked by qualified specialists.

Safety tips

- To minimize the risk of fire in the microwave: When heating food in plastic or paper containers, always keep an eye on the microwave when it is in operation, as these materials can catch fire.
- When heating drinks in the microwave, bubbling may be delayed when the drink boils. Therefore, be careful when handling the container. To avoid sudden simmering:
 - If possible, place a glass rod in the fluid for as long as it is being heated.
 - To avoid an unexpected reboiling, leave the fluid to stand in the microwave oven for ca. 20 seconds after being warmed up.
- Puncture the skins of potatoes, sausages or similar. Otherwise, they could explode.
- Proceed with caution when warming up fluids. Use only open containers, so that any air bubbles produced can escape.
- Should you notice smoke, switch the appliance off or remove the plug from the socket and keep the door closed to suffocate any possible flames.

- Eggs in their shells and hard-boiled eggs should not be heated in the microwave oven as they could explode, even on completion of the heating process. Food with thick skins, such as potatoes, whole pumpkins, apples and chestnuts must be pricked before cooking.
- Do not transport the microwave oven when it is in use.

Earthing information/correct installation

This appliance must be earthed. This appliance is to be connected only to a correctly earthed power socket. An individual circuit, solely for the connection of the microwave oven, is recommended.

 **Danger:** Improper use of the earthing connector could increase the risk of an electric shock.

 **Note:** Should you have any questions about earthing or about the instructions on the use of this electrical appliance given here, please consult an electrician or a maintenance technician.

Neither the manufacturer nor the dealer can accept liability for damage to the microwave oven or injury to persons resulting from failure to comply with the instructions for electrical connection.

Interference with other appliances

The operation of the microwave may cause interference on your radio, television or similar appliances.

If such interference should occur, they may be reduced or corrected by the following remedial measures:

- Clean the door and the seal of the microwave.
- Re-align the receiver antenna of your radio or television.
- Position the microwave in a different place to the receiver.
- Move the microwave away from the receiver.

- Plug the microwave into another wall socket. The microwave and the receiver should be connected to different circuits.

Items supplied

Microwave
Glass plate
Grill stand
Star rotator
Operating instructions
Concise instruction sheet

Technical Data

Power rating:	230 - 240 V ~ 50 Hz
Maximum power consumption:	1200 W
Maximum power output	
Microwave:	800 W
Maximum power consumption	
Grill:	1000 W
Microwave frequency:	2450 MHz

Before you begin

Basic principles of microwave cookery

- Arrange the food with consideration.
- The thickest parts near the edges.
- Pay attention to the cooking time. Select the shortest possible stated cooking time and increase as required. Food that is cooked too long can begin to smoke or catch fire.
- Cover the food during cooking with a lid suitable for microwave cookery. The lid prevents splashing and helps in the even cooking of the food.
- While cooking, turn the food in the microwave once so that items such as chicken or hamburgers are cooked more quickly.
- Large pieces of food, such as joints of meat, must be turned at least once.
- Completely re-arrange foods such as meatballs after half the cooking time. Turn them and move the meatballs from the middle of the cookware to the edge.

Use suitable cookware

- The ideal material for a microwave oven is microwave-permeable, allowing the energy to penetrate the container to heat the food. Microwaves cannot permeate metal. Therefore, metal containers and cookware should not be used.
Microwaves cannot permeate metal. For this reason metal containers and cookware should not be used.
- When using the microwave for heating do not use products made of recycled paper. These can contain minute fragments of metal, which can generate sparks and/or fires.









- We recommend the use of round/oval cookware instead of square or oblong containers, as food in corner areas tends to overcook.
The following list provides general hints to assist you in selecting the correct cookware.

Cookware	Micro-wave oven	Grill	Combi-nation
Heat-resistant glass	Yes	Yes	Yes
Non-heat-resistant glass	No	No	No
Heat-resistant ceramics	Yes	Yes	Yes
Plastic crockery suitable for microwave	Yes	No	No
Kitchen roll	Yes	No	No
Metal tray/plate	No	Yes	No
Grill stand	No	Yes	No
Alufoil & Foil containers	No	Yes	No

Warning:

Never use the grill stand or other metallic objects when you are using the appliance in the microwave mode or in the combination cooking process. Metals reflect the microwave radiation and it leads to the generation of sparks. This could cause a fire and irreparably damage the appliance!

Description of the appliance

- 1 Display
- 2 Door opener button
- 3 Glass plate
- 4 Star rotator
- 5 Cold air intake
- 6 Grill Button 
- 7 Weight/Amount Button 
- 8 Defrosting button 
- 9 Time Button 
- 10 Stop button 
- 11 Control dial/Start/Quickstart 
- 12 Kitchen timer button 
- 13 Combination Button **COMB.**
- 14 Operation button 
- 15 Grill stand

- Ensure that the electrical plug is accessible without problem, so that in case of danger it can be easily reached and removed.
- Do not remove the pads underneath the microwave oven.
- Do not block the ventilation slots 5. If you do, it could damage the appliance.
- Install the appliance as far away as possible from radios and televisions. The operation of the microwave oven can cause malfunctions to radio and television reception.

Warning:

Do not install the microwave above a cooker or any other appliance generating heat. Installation in such a location could cause damage to the appliance and lead to a subsequent cancellation of the warranty provisions.

Commissioning

Installation of the appliance

Warning:

This microwave oven is not suitable for installation in a kitchen cabinet. In closed cabinets sufficient ventilation for the appliance cannot be assured. The appliance could be damaged and there would be the additional risk of a fire!

- Select an even surface offering sufficient space for the adequate ventilation of the appliance: Ensure that you maintain a minimum distance of 10 cm from neighbouring walls/surfaces. Ensure that the door of the microwave oven can be opened easily. Maintain a gap of at least 20 cm above the microwave oven.

Preparing the appliance

- Remove all packaging materials and any protective film on the surface of the housing.





Note:

Do not remove the light grey flimmer cover plate, which is mounted in the cooking area to protect the magnetron.

- Insert the plug into a power socket. Use a 230 - 240 V, 50Hz, mains power socket with a 16A fuse. It is recommended that the microwave oven is powered from its own ring main. If you are unsure about how to connect the microwave oven, consult a specialist.

Before the first regular usage of the microwave oven the appliance must be heated up to remove any remaining production residues.

Without foodstuffs or accessories (glass plate **3**, star roller **4** and grill stand **15**), switch the appliance on in the mode Grill:

- Press the button Grill once **6** . With this you select the Grill operation. In the display **1** appears the symbol  and the symbol  blinks. This indicates readiness to start.
- Adjust the control dial **11** to a cooking time of 10 minutes.
- Press the button Start/Quick start **11**  to start the grilling process.

Note:

On the first usage, the generation of light smoke and a slight smell can occur, this is due to the production residues. This is unharmed. Provide for sufficient ventilation. For example, open a window.

- After 10 minutes, the appliance switches itself off automatically. Signal tones sound. Open the door. Wait until it has cooled down completely.
- Remove the plug from the mains power socket then, after cleaning the appliance with a moist cloth, dry it carefully.







Inserting accessories

- Place the star rotator **4** centrally on the drive shaft in the cooking area. Ensure that it slides completely onto the axle and is firmly seated.
- Place the glass plate **3** centrally on the star rotator. The three rollers must be seated on the leading edge on the glass plate **3**.

Operation

Setting the Clock



When you take the microwave oven into use for the first time, or there has been a power cut, the display **1** indicates "1 : 0 1".

1. Press the button Clock **9** . "Hr 12" appears in the display **1**. Press the button Clock **9**  once again should you wish to switch to the 24-hour mode.
2. By turning the control dial **11** programme in the current hour. The clock symbol  in the display **1** blinks.
3. Press the button Clock **9** . The minute indicator appears.
4. By turning the control dial **11**, programme in the current minute.
5. When the correct time is programmed in, press the button Clock **9** . The clock symbol  in the display **1** glows continuously and the colon indicates, by blinking, that the clock is running.

To read off the current time when the microwave oven is in operation, press the button Clock **9** ; the time will then be indicated in the display **1** for approx. 4 seconds.



Setting the kitchen timer

The microwave oven is provided with a kitchen timer which you can use independently of the microwave operation.

1. Press the button Kitchen timer **12**  when the appliance is in standby mode. In the display appears **1** "00:10".
2. Now set the desired time using the control dial **11**. You can select any time range from 10 seconds to 95 minutes.
3. Press button Start/Quick Start **11** . The appliance emits an acoustic signal. The count down begins. After approx. 3 seconds the current time is shown once again.

The cooking timer progresses further in the background. If you wish to check the progress of the kitchen timer, press the kitchentimer button **12** . It appears for a brief period in the kitchen timer. As soon as the set time has expired you will hear 3 signal tones.





Take note:

To stop the countdown of the kitchen timer, press the button Kitchen timer **12**  so that the remaining time of the kitchen appears in the display. Press, during the period that the remaining time of the kitchen timer is being shown in the display **1**, the Stop **10**  button. The kitchen timer will then be cancelled and the current time appears in the display **1**.

Child protection system

Engage this setting to prevent accidental activation by children and other persons not familiar with the operation of the appliance.

The symbol for Child safety  appears in the display **1** and, for as long as this function is activated, the appliance cannot be put into operation.

- Press and hold the button Stop **10**  until a signal tone sounds and the symbol for Child Safety  appears in the display **1**. The buttons and the control dial now no longer have a function.
- To deactivate Child Safety, press and hold the Stop button **10**  until a signal tone sounds and the symbol for Child Safety  extinguishes.

Query functions

Query the time during operation

During the cooking process press the button Clock **9** .

The time appears in the display **1** for approx. 4 seconds.

Query the power level operation

During the cooking process press the button Operation **14** .

In the display **1** the activated operational level appears for approx. 3 seconds.

Heating and cooking

Microwave operation

Notice

During the cooking process, drops of water can form on the oven door or on the housing. This is normal and is not an indication of a malfunction. When the appliance has cooled down, wipe the moisture off with a dry cloth.

Warning:

Never use the grill stand **15** or other metallic objects when you are using the appliance in the microwave mode. Metals reflect the microwave radiation and it leads to the generation of sparks. This could cause a fire and irreparably damage the appliance!

Selecting the operation level

- Press the button Operation **14**  the appropriate number of times to set the required power level.
- **1x** for 800 Watts of power (P800).
- **2x** for 700 Watts of power (P700).
- **3x** for 600 Watts of power (P600).
- **4x** for 500 Watts of power (P500).
- **5x** for 400 Watts of power (P400).
- **6x** for 300 Watts of power (P300).
- **7x** for 200 Watts of power (P200).
- **8x** for 100 Watts of power (P100).

The power setting level is indicated in the display **1** (e.g. P800 at 800 Watts of power).

Programming the cooking time

After you have selected the power level, programme in the desired cooking time:

- Turn the control dial **11**, until the desired cooking time has been programmed in.





The increments for setting the time with the control dial ① are as follows:

- from 10 sec. to 5 min: in 10 second increments
- from 5 to 10 min: in 30 second increments
- from 10 to 30 min: in 1 minute increments
- from 30 to 95 min: in 5 minute increments



Aborting/stopping an input process

Press the button Stop ⑩  once to cancel or end input of data. The appliance reverts to standby mode.

Starting the cooking process

When you have programmed in the power level and the cooking time, and the symbol  blinks in the display ①, you can start the cooking process: To start the cooking process, press button Start/Quickstart ⑪ . In the display ① the symbols for microwave operation  and cooking  or  appear. The programmed time counts backwards.

Interrupting the cooking process

Press the button Stop ⑩  once to interrupt a cooking process. The appliance interrupts the cooking process and stops the remaining time. Press the button Start/Quick start ⑪  to continue the cooking process.

Abort the cooking process



Press the button Stop ⑩  twice to stop the cooking process. The appliance reverts to standby mode.

Cooking process is finished

When a cooking process is complete, "End" appears in the display ① and 4 signal tones sound. If the door of the microwave is not opened, the signal tones sound again after about 2 minutes.

Quick start

With this function you can immediately begin cooking at 800W power for 30 seconds (or longer, up to 12 minutes).



- Press the button Start/Quick Start ⑪  once. In the display ① appear the symbols for microwave operation  and cooking , as well as ":30". The microwave starts the cooking process for 30 seconds. The count down begins.

Should you wish to cook for a longer period, repeatedly press the button Start/Quickstart ⑪  until the desired time is reached.

Grill operation

You can use the grill function for thin slices of meat, steaks, hamburgers, sausage or chicken pieces. It is also excellent for use in making topped sandwiches and gratins. Always use the grill stand ⑮ for grilling. To achieve an optimal grilling result.

Always place the Grill stand ⑮ on the Glass plate ③.

1. Press the button Grill ⑥  to activate the grill function. In the display ① appears the symbol for the grill function  and „:10“.
2. Using the control knob ⑪, set the required cooking time. The maximum possible cooking time setting is 95 minutes.
3. To start the grilling function press the button Start/Quick start ⑪ .
4. Turn the meat after about half of the cooking time.

Combination cooking processes

This function combines the grill function and the normal microwave operation. In combined mode, the microwave automatically cooks for a certain amount of time and grills for the remaining time. You may notice a quiet clicking noise when the oven is switching between modes.

Warning:

Never use the grill stand **15**, or other metallic objects, when you are using the appliance in the combination cooking process. Metals reflect the microwave radiation and it leads to the generation of sparks. This could cause a fire and irreparably damage the appliance!

Combination 1

In Combination 1 the microwave element amounts to 30% and the grill element amounts to 70% of the cooking time. This is suitable for, for example, fish, potatoes or gratins.

1. Press the button Combination **13** **COMB**, once to activate combination 1. In the display **1** appears **COMB1** as well as „:10“.
2. Using the control dial **11** set the required cooking time. The maximum possible cooking time setting is 95 minutes.
3. To start, press the button Start/Quick start **11** .

Combination 2

In Combination 2 the microwave element amounts to 55% and the grill element amounts to 45% of the cooking time. This is suitable for, for example, puddings, omelettes, poultry dishes or lasagne.

1. Press the button Combination **13** **COMB**, twice to activate combination 2. In the display **1** appears **COMB2** as well as „:10“.
2. Using the control dial **11** set the required cooking time. The maximum possible cooking time setting is 95 minutes.
3. To start, press the button Start/Quick start **11** .

Auto menu









For foods that are intended to be prepared in the Auto Menu modus it is not necessary to programme in the period of the cooking process and the power level. It is quite sufficient to enter which type of food is to be cooked/boiled, and its weight.







Notice

The microwave calculates the time/operational level for **fresh** foods. Frozen foods will not be cooked with the times programmed into the microwave. If needs be, defrost frozen foods with the defrost programme beforehand (see section "Defrosting").

Starting the Auto-menu



1. Turn the Control dial **11** slowly to the left. In the display **1** appears a number (e.g. "3" for Auto Programme 3 (fish)), the Symbol "Fish" and **AUTO**. Select the appropriate Auto-menu for your foodstuff (1 to 9).

Nr.	Symbol	Foodstuff	Weight (Portions)
1		Beverages	1 - 3
2		Noodles	100 - 300g
3		Fish	100 - 1000g
4		Rice	100 - 1000g
5		Chicken	800 - 1400g
6		Warming	100 - 1000g
7		Potatoes	150 - 600g
8		Roasting	300 - 1300g
9		Kebabs	100 - 700g

2. Press, repeatedly if need be, the button Weight/Amount   until the required weight resp. required number of portions appears in the display . The symbol  blinks.
3. Press the button Start/Quick start   to start the cooking process.

Note

In order to achieve an even cooking or warming, in the programmes 5, 8 and 9 the food should be turned over after about two thirds of the cooking time. The microwave automatically interrupts the programme after this time: "turn" appears in the display  and signal tones sound to remind you of the requirement for turning the food.

- Open the door and turn the food over. Proceed cautiously with the possibly already hot food.
- Press the button Start/Quickstart   to continue the cooking process.

Take note:

If you wish to dispense with turning, simply wait for the signal tones to finish. The microwave continues your programme automatically after approx. 30 seconds.

Notice

Should the meal not be properly cooked on completion of the auto-menu, continue cooking for a couple of minutes with the Quick start programme. For programmes that continue with utilisation of the grill function (Programme numbers 5, 8 and 9), the food can be cooked further with the grill function. Extended cooking with the grill function also increases the browning level of the food.

Important

When using the programmes with incorporated grill function, under no circumstances should you use any form of covering or cookware that is not heat resistant, as these could melt or ignite themselves!

Risk of injury!

After a cooking process, the Glass plate  is very hot! You should therefore always use an oven cloth or heat resistant oven gloves when removing it from the cooking area.

Note:

Take note that size, shape and the type of foodstuff determines the result of the cooking process.

Programmes in detail

Programme 1: Beverages

This programme runs only with utilisation of microwave power. Subject to the number of portions, the programme runs for between 1:30 and 3:50 minutes.

- Place the beverage that you wish to heat up on the Glass plate  in the cooking area. If you wish to place several glasses or cups in the microwave oven, ensure that the receptacles do not touch each other.

Notice

To avoid sudden simmering:

- If possible, place a glass rod in the fluid for as long as it is being heated.
- To avoid an unexpected reboiling, leave the fluid to stand in the microwave oven for ca. 20 seconds after being warmed up.

Programme 2: Noodles

This programme runs only with utilisation of microwave power.

Subject to the weight programmed in, this programme runs for between 25 and 35 minutes.

- When cooking noodles use a tall container, as there is a great risk of it boiling over.
- Use as much water as you would in conventional cooking. The noodles should "swim" in the water.
- First bring the the water to the boil: Set the microwave to its highest performance level (P800) and then start it. For a liter of water you need about 10 minutes to bring the water to the boil.

- Then add the noodles. After this, you can start the auto-menu for noodles.
- Finally, allow the noodles to stand for approx. 3 minutes.

Programme 3: Fish

This programme runs only with utilisation of microwave power.

Subject to the weight programmed in, this programme runs for between approx 3:30 and 16 minutes.

- Lay the pieces of fish on a plate suitable for microwave ovens, add a little butter or an other fat, add flavouring to taste and then start the auto-menu for fish.

Programme 4: Rice

This programme runs only with utilisation of microwave power.

Subject to the weight programmed in, this programme runs for between 16 and 36 minutes.

- When cooking rice use a tall container, as there is a great risk of it boiling over. Use 400 ml water for, for example, 200 gr of rice. Use the weight adjustment "200g" despite the water. It is always the weight of the rice that is to be set.
- Place the rice in the container, fill it with the required volume of liquids and then allow the rice to swell for approx 3 minutes.
- Cover the container. Ensure that it is not sealed airtight. After this, you can start the auto-menu for rice.

Programme 5: Chicken

This programme runs over several cooking stages, using microwave power and the grill function.

Subject to the weight programmed in, this programme runs for between 39 and 50 minutes.

- Place the chicken on a plate suitable for microwave ovens.
- Season to taste and then start the auto-menu for chicken.

- A whole chicken must be turned, otherwise the side facing upwards could dry out. For this reason the microwave oven automatically interrupts the programme after about 2/3 of the time has elapsed and a signal tone sounds.
Turn the chicken and then press the button Start/Quick start **1**  once again to continue the programme.

Programme 6: Warming

This programme runs only with utilisation of microwave power.

Subject to the weight programmed in, this programme runs for between approx 1:00 and 6:20 minutes.

- Place the receptacle with the foodstuff that you wish to warm up on the glass plate **3** in the cooking area and then start the auto-menu for warming.

Programme 7: Potatoes

This programme runs only with utilisation of microwave power.

Subject to the weight programmed in, this programme runs for between 3:50 and 11 minutes.

Tip!

Use unpeeled potatoes for the cooking process. Prick the skins a couple of times.

- Place the unpeeled potatoes onto a plate suitable for microwave ovens or into a receptacle. As far as possible, use potatoes of the same size. If possible, the potatoes should not touch each other.

Programme 8: Roasting

This programme runs over several cooking stages, using microwave power and the grill function.

Subject to the weight programmed in, this programme runs for between 16 and 60 minutes.

- Place the roast on a plate suitable for microwave ovens. Season to taste and then start the auto-menu for roasting.

- A whole roast must be used, otherwise the side facing upwards could dry out. For this reason the microwave oven automatically interrupts the programme after about 2/3 of the time has elapsed and a signal tone sounds. Turn the roast and then press the button Start/Quick start **1**  once again to continue the programme.

Programme 9: Kebabs

This programme runs over several cooking stages, using microwave power and the grill function. Subject to the weight programmed in, this programme runs for between 9 and 27 minutes.

- Place the kebabs on a plate suitable for microwave ovens. Season to taste and then start the auto-menu for kebabs.
- The kebabs must be turned to ensure even cooking. For this reason the microwave oven automatically interrupts the programme after about 2/3 of the time has elapsed and a signal tone sounds. Turn the kebabs and then press the button Start/Quick start **1**  once again to continue the programme.

Defrosting

This function enables you to defrost meat, poultry and fish with ease. The defrosting time and the power level are calculated and set automatically once you have entered the weight.

1. Press button Defrosting **8** . In the display **1** appears **AUTO** and . The symbol  blinks.
2. Using the control dial **1** enter in the weight of the foodstuff to be defrosted. You can enter in a weight of between 100 g and 1800 g.
3. Press button Start/Quick Start **1** .

The appliance calculates the defrosting time automatically. It appears in the display **1** and starts to countdown.

The microwave oven automatically interrupts the defrosting after about 1/2 of the time and a signal tone sounds. Turn the food that is being defrosted and then press the button Start/Quick start **1**  once again to continue the programme.

Note:



If you wish to dispense with turning, simply wait for the signal tones to finish. The microwave continues your programme automatically after approx. 30 seconds.





Presetting the start time

With this programme you can preset a specific start time for the cooking or grilling of the foodstuff. If the programming is carried out correctly, the appliance starts automatically at the programmed time.



Take note:

The clock must be correctly set to be able to select the function " Presetting the start time".

1. Programme in the required microwave function (cooking, grilling or automatic-menu (except auto-programme 6):
For microwave operation: Press the button Operation **14**  the appropriate number of times to set the required power level. Programme the cooking time with the rotary switch **1**.
For grill operation: Press the button Grill **6**  to activate the grill function.
Set the desired grilling time using the rotary switch **1**.
For automatic-menu: Using the control dial **1** select the appropriate programme for your foodstuff (excluding auto-programme 6). Press the button Weight/Amount **7**  as required until the desired measure appears in the display **1**.

2. Press the button Clock **9**  . In the display **1** „01: “ blinks and the hour-glass symbol  appears.
3. Turn the control knob **11** to programme the hours.
4. Press the clock button **9**  , now the minute figures appear.
5. Turn the control knob **11** to programme the minutes.
6. Press the button Start/Quick start **11**  . The hour-glass symbol  blinks. The start time is shown. The microwave oven automatically starts the cooking process at the programmed time.
A signal tone sounds when it starts.

Take note:

To erase the saved start time and thus cancel the saved procedure, press the Stop **10**  button. The hourglass symbol  disappears and the time is displayed.

Cleaning and Care

Risk of personal injury!

Before cleaning, switch the microwave oven off and remove the plug from the mains power socket.

-  Under no circumstances should you immerse the appliance in water or other liquids. This could result in you receiving a fatal electric shock and the appliance could be damaged.

- Always keep the interior of the microwave oven clean.
- If splashes of food or spilt liquids stick to the walls of the microwave, wipe them off with a damp cloth.
- Use a mild detergent if the microwave is more heavily soiled.
- Avoid using cleaning sprays and other aggressive cleaning agents, as they can cause stains, stripes or a blurring of the door surface.
- Clean the external walls with a damp cloth.

- To avoid damage to the functional components in the interior of the microwave, do not let liquids seep in through the ventilation slits **5**.
- Regularly remove splashes or contaminants. Clean the door, both sides of the viewing window, the door seals and adjacent components with a damp cloth. Do not use abrasive cleaning agents.
- If steam should collect on or around the outside of the appliance door, wipe it off with a soft towel. This can happen if the microwave is operated in extremely humid conditions.
- Clean the Glass plate **3** regularly. Clean the plate in warm soapy water or in the dishwasher.
- Clean the grill stand **15** in warm dishwater and dry it well.
- Regularly eliminate odours. Put a deep microwave bowl with a cup of water, juice and peel of a lemon into the microwave. Heat for 5 minutes. Wipe off thoroughly and rub dry with a cloth.
- Should replacement of the bulb in the microwave be necessary, arrange for it to be exchanged by a dealer or consult our Service Department.

Troubleshooting

The display **1** indicates nothing.

- The plug is not inserted into a power socket. Check the plug.
- The mains power socket is defective. Try another mains power socket.
- The display **1** is defective. Contact our Customer Services Department.

The appliance does not respond to pressing the buttons.

- The Child safety facility is activated. Deactivate the Child safety facility (see chapter "Operation").

The appliance does not start the cooking/warming process.

- The door is not properly closed. Close the door correctly.

The Glass plate ③ generates loud noise when revolving.

- The Glass plate ③ is not correctly positioned on the star rotator ④. Insert the Glass plate ③ correctly into the cooking area.
- The star rotator ④ and/or the floor of the cooking area are unclean. Clean the star rotator ④ and the floor of the cooking area.

Disposal



Do not dispose of this appliance in your normal domestic waste. This product is subject to the provisions of European Directive 2002/96/EC.

Dispose of the appliance through an approved disposal centre or at your community waste facility.

Observe the currently applicable regulations.

In case of doubt, please contact your waste disposal centre.



Dispose of all packaging materials in an environmentally friendly manner.

Warranty and Service

The warranty for this appliance is for 3 years from the date of purchase. The appliance has been manufactured with care and meticulously examined before delivery. Please retain your receipt as proof of purchase. In the event of a warranty claim, please make contact by telephone with our Service Department. Only in this way can a post-free despatch for your goods be assured.

The warranty covers only claims for material and manufacturing defects, but not for transport damage, for wearing parts or for damage to fragile components, e.g. buttons or batteries. This product is for private use only and is not intended for commercial use. The warranty is void in the case of abusive and improper handling, use of force and internal tampering not carried out by our authorized service branch. Your statutory rights are not restricted in any way by this warranty.

The warranty period will not be extended by repairs made under warranty. This applies also to replaced and repaired parts. Any damage and defects extant on purchase must be reported immediately after unpacking the appliance, at the latest, two days after the purchase date. Repairs made after the expiration of the warranty period are subject to payment.

DES UK LTD

Tel.: 0871 5000 700 (£ 0.10 / minute)

e-mail: support.uk@kompernass.com

Kompernass Service Ireland

Tel: 1850 930 412 (0,082 EUR/Min.)

Standard call rates apply. Mobile operators may vary.

e-mail: support.ie@kompernass.com

Importer

KOMPERNASS GMBH
BURGSTRASSE 21
44867 BOCHUM, GERMANY

www.kompernass.com