

# SHARP

**Important**

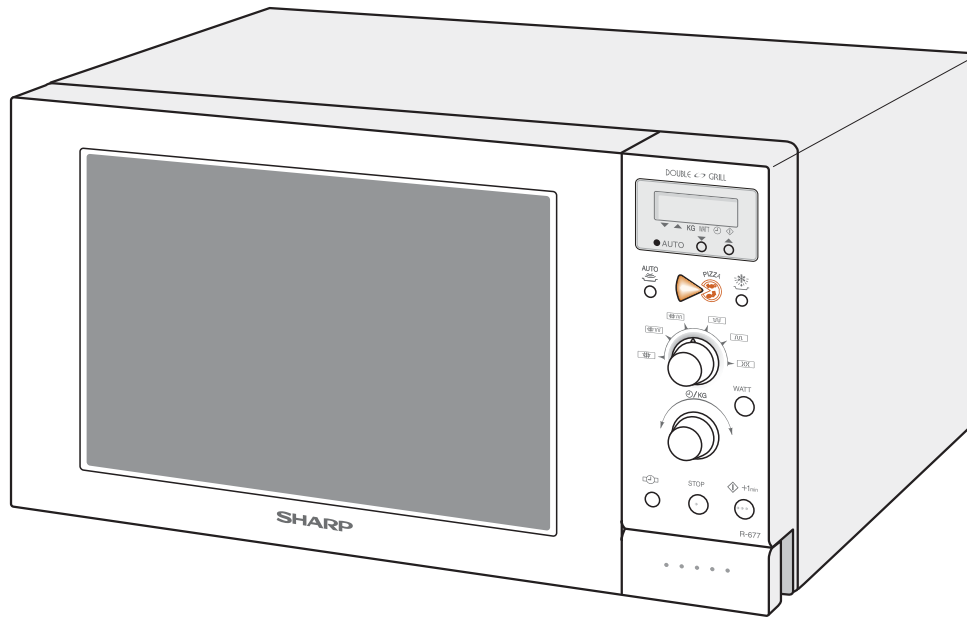

## **R-677 / R-677F MICROWAVE OVEN WITH TOP AND BOTTOM GRILL**

### **OPERATION MANUAL WITH COOKBOOK**

#### **OPERATION MANUAL**

This operation manual contains important information which you should read carefully before using your microwave oven.

**IMPORTANT:** There may be a serious risk to health if this operation manual is not followed or if the oven is modified so that it operates with the door open.

### **800 W (IEC 60705)**

ENGLISH

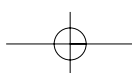
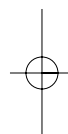
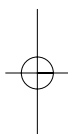
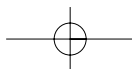



# CONTENTS



OVEN AND ACCESSORIES .....	2
CONTROL PANEL .....	3
IMPORTANT SAFETY INSTRUCTIONS .....	4-6
INSTALLATION .....	6
BEFORE OPERATION .....	7
SETTING THE CLOCK .....	7
ENERGY SAVE MODE .....	8
MICROWAVE POWER LEVELS .....	9
MICROWAVE COOKING .....	10
GRILL COOKING .....	11
DUAL COOKING .....	12
OTHER CONVENIENT FUNCTIONS .....	13-14
AUTOMATIC OPERATION .....	15-16
PIZZA CHART .....	16
AUTO COOK CHART .....	17
AUTO DEFROST CHART .....	18
RECIPES FOR AUTOCOOK AC-5 .....	19
CARE AND CLEANING .....	20
SERVICE CALL CHECK .....	21
SERVICE ADDRESSES .....	22-27
SPECIFICATIONS .....	28

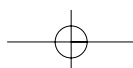
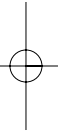
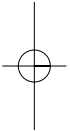

## OVEN AND ACCESSORIES

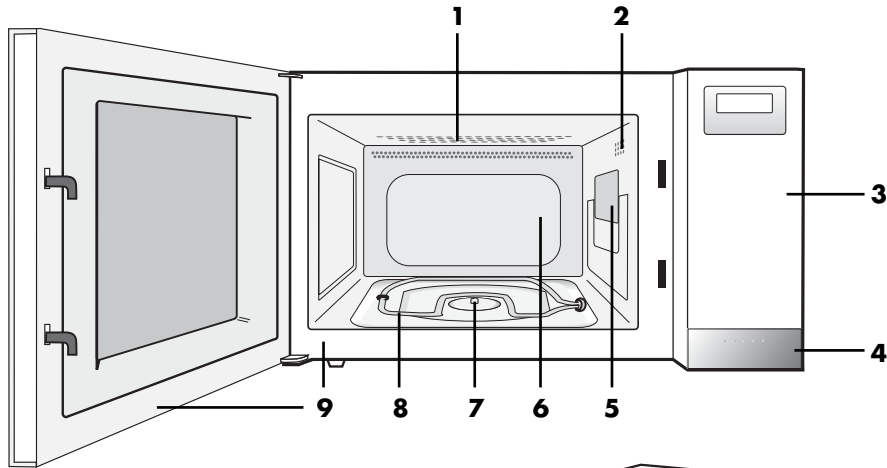

1. Grill heating element (top grill)
2. Oven lamp
3. Control panel
4. Door opening button
5. Waveguide cover
6. Oven cavity
7. Turntable motor shaft
8. Grill heating element (bottom grill)
9. Door seals and sealing surfaces

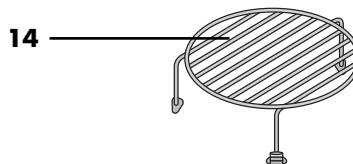
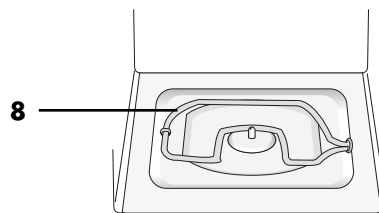
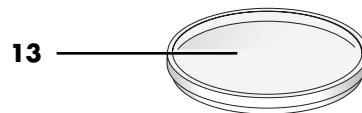
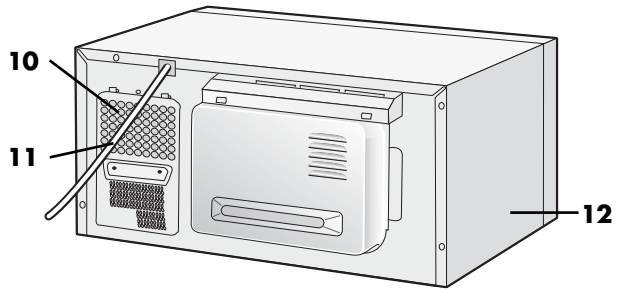

### ACCESSORIES:

Check to make sure the following accessories are provided:

13. Turntable
14. Rack

Place the turntable over the turntable motor shaft on the floor of the cavity.

Before first using the turntable and the rack, clean with mild soapy water.

Do not cut or scratch the turntable.

### WARNING:

**The accessories (e.g. turntable) will become very hot during Grill, Dual and Automatic operation (except Auto Defrost) modes. Always use thick oven gloves when removing the food or turntable from the oven to prevent burns.**

### NOTE:

When you order accessories, please mention the part name and model name to your dealer or SHARP authorised service agent.

## CONTROL PANEL

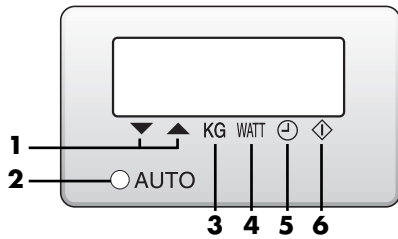

### Digital Display and Indicators

- 1 **LESS/MORE** indicator
- 2 **AUTO** indicator - will light during automatic operation
- 3 **WEIGHT (KG)** indicator
- 4 **MICROWAVE (WATT)** indicator
- 5 **CLOCK SET/TIMER** indicator
- 6 **COOKING IN PROGRESS** indicator

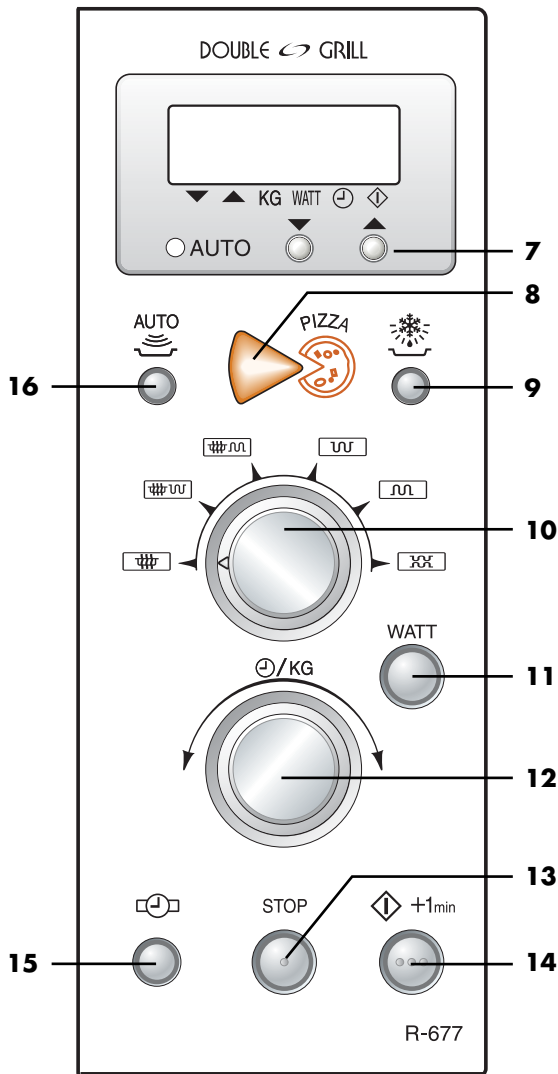

### Operating buttons

- 7 **LESS/MORE** buttons
- 8 **PIZZA** button
- 9 **AUTO DEFROST** button
- 10 **COOKING MODE** dial  
Rotate the dial so that indicator points to appropriate symbol:
  - Microwave
  - Microwave and Top Grill
  - Microwave and Bottom Grill
  - Top Grill
  - Bottom Grill
  - Top and Bottom Grills
- 11 **WATT** button
- 12 **TIME/WEIGHT** dial
- 13 **STOP** button
- 14 **(START) +1 min** button
- 15 **CLOCK** button
- 16 **AUTO COOK** button



## IMPORTANT SAFETY INSTRUCTIONS

### IMPORTANT SAFETY INSTRUCTIONS: READ CAREFULLY AND KEEP FOR FUTURE REFERENCE

#### To avoid the danger of fire

**The microwave oven should not be left unattended during operation. Power levels that are too high or cooking times that are too long may overheat foods resulting in a fire.**

This oven is not designed to fit into a kitchen unit. The electrical outlet must be readily accessible so that the unit can be unplugged easily in an emergency.

The AC power supply must be 230 V, 50 Hz, with a minimum 16 A distribution line fuse, or a minimum 16 A distribution circuit breaker.

It is recommended that a separate circuit serving only this appliance be provided.

Do not place the oven in areas where heat is generated. For example, close to a conventional oven.

Do not install the oven in an area of high humidity or where moisture may collect.

Do not store or use the oven outdoors.

**If food being heated begins to smoke, DO NOT OPEN THE DOOR. Turn off and unplug the oven and wait until the food has stopped smoking. Opening the door while food is smoking may cause a fire.**

**Use only microwave-safe containers and utensils. See Page X.**

**Do not leave the oven unattended when using disposable plastic, paper or other combustible food containers.**

**Clean the waveguide cover, the oven cavity and the turntable after use. After cooking fatty foods without a lid, always clean the cavity and especially the grill heating elements thoroughly. These must be dry and free from grease. Built-up grease may overheat and begin to smoke or catch fire.**

Do not place flammable materials near the oven or ventilation openings. Do not block the ventilation openings.

Remove all metallic seals, wire twists, etc., from food and food packages. Arcing on metallic surfaces may cause a fire.

Do not use the microwave oven to heat oil for deep frying. The temperature cannot be controlled and the oil may catch fire.

To make popcorn, use only special microwave popcorn makers.

Do not store food or any other items inside the oven.

Check the settings after you start the oven to ensure the oven is operating as desired.

See the corresponding hints in the cookery book section.

#### To avoid the possibility of injury

##### WARNING:

Do not operate the oven if it is damaged or malfunctioning. Check the following before use:

- a) The door; make sure the door closes properly and ensure it is not misaligned or warped.
- b) The hinges and safety door latches; check to make sure they are not broken or loose.
- c) The door seals and sealing surfaces; ensure that they have not been damaged.
- d) Inside the oven cavity or on the door; make sure there are no dents.
- e) The power supply cord and plug; ensure that they are not damaged.

**Never adjust, repair or modify the oven yourself. It is hazardous for anyone other than a competent person to carry out any service or repair operation which involves the removal of a cover which gives protection against exposure to microwave energy.**

Do not operate the oven with the door open or alter the door safety latches in any way.

Do not operate the oven if there is an object between the door seals and sealing surfaces.

**Do not allow grease or dirt to build up on the door seals and adjacent parts. Follow instructions for "Care and Cleaning", Page 20.**

Individuals with PACEMAKERS should check with their doctor or the manufacturer of the pacemaker for precautions regarding microwave ovens.

#### To avoid the possibility of electric shock

Under no circumstances should you remove the outer cabinet.

Never spill or insert any objects into the door lock openings or ventilation openings. In the event of a spill, turn off and unplug the oven immediately, and call an authorised SHARP service agent.

## IMPORTANT SAFETY INSTRUCTIONS



Do not immerse the power supply cord or plug in water or any other liquid.

Do not let the power supply cord hang over the edge of a table or work surface.

Keep the power supply cord away from heated surfaces, including the rear of the oven.

Do not attempt to replace the oven lamp yourself or allow anyone who is not an electrician authorised by SHARP to do so. If the oven lamp fails, please consult your dealer or an authorised SHARP service agent.

If the power supply cord of this appliance is damaged, it must be replaced by an authorised SHARP service agent.

### To avoid the possibility of explosion and sudden boiling:

**WARNING: Liquids and other foods must not be heated in sealed containers since they are liable to explode.**

Never use sealed containers. Remove seals and lids before use. Sealed containers can explode due to a build up of pressure even after the oven has been turned off.

Take care when microwaving liquids. Use a wide-mouthed container to allow bubbles to escape.

**Microwave heating of beverages can result in delayed eruptive boiling, therefore care has to be taken when handling the container.**

To prevent sudden eruption of boiling liquid and possible scalding:

1. Stir liquid prior to heating/reheating.
2. It is advisable to insert a glass rod or similar utensil into the liquid whilst reheating.
3. Let liquid stand for at least 20 seconds in the oven at the end of cooking time to prevent delayed eruptive boiling.

**Do not cook eggs in their shells, and whole hard boiled eggs should not be heated in microwave ovens since they may explode even after microwave cooking has ended. To cook or reheat eggs which have not been scrambled or mixed, pierce the yolks and the whites, or the eggs may explode. Shell and slice hard boiled eggs before reheating them in the microwave oven.**

Pierce the skin of such foods as potatoes, sausages and fruit before cooking, or they may explode.

### To avoid the possibility of burns

Use pot holders or oven gloves when removing food from the oven to prevent burns.

Always open containers, popcorn makers, oven cooking bags, etc., away from the face and hands to avoid steam burns.

**To avoid burns, always test food temperature and stir before serving and pay special attention to the temperature of food and drink given to babies, children or the elderly.**

Temperature of the container is not a true indication of the temperature of the food or drink; always check the food temperature.

Always stand back from the oven door when opening it, to avoid burns from escaping steam and heat.

Slice stuffed baked foods after heating to release steam and avoid burns.

Keep children away from the door to prevent them burning themselves.

Do not touch the oven door, outer cabinet, rear cabinet, oven cavity, ventilation openings, bottom grill, accessories and dishes during **GRILL, DUAL** and **AUTOMATIC** operation (except **AUTO DEFROST**) as they will become hot. Before cleaning make sure they are not hot.

### To avoid misuse by children

**WARNING: Only allow children to use the oven without supervision when adequate instructions have been given so that the child is able to use the oven in a safe way and understands the hazards of improper use.**

Do not lean or swing on the oven door. Do not play with the oven or use it as a toy.

Children should be taught all important safety instructions: use of pot holders, careful removal of food coverings; paying special attention to packaging (e.g. self-heating materials) designed to make food crisp, as they may be extra hot.

### Other warnings

Never modify the oven in any way.

Do not move the oven while it is in operation.

This oven is for home food preparation only and may only be used for cooking food. It is not suitable for commercial or laboratory use.



## IMPORTANT SAFETY INSTRUCTIONS

### To promote trouble-free use of your oven and avoid damage.

Never operate the oven when it is empty except where recommended in the operation manual, see Page 11. Doing so may damage the oven.

When using a browning dish or self-heating material, always place a heat-resistant insulator such as a porcelain plate under it to prevent damage to the turntable due to heat stress. The preheating time specified in the dish's instructions must not be exceeded.

Do not use metal utensils, which reflect microwaves and may cause electrical arcing. Do not put cans in the oven.

Use only the turntable designed for this oven.

Do not place anything on the outer cabinet during operation.

Do not use plastic containers for microwaving if the oven is still hot from using the **GRILL, DUAL** and **AUTOMATIC** operation (except **AUTO DEFROST**), because they may melt. Plastic containers must not be used during above modes unless the container manufacturer says they are suitable.

#### NOTE:

If you are unsure how to connect your oven, please consult an authorised, qualified electrician.

Neither the manufacturer nor the dealer can accept any liability for damage to the oven or personal injury resulting from failure to observe the correct electrical connection procedure.

Water vapour or drops may occasionally form on the oven walls or around the door seals and sealing surfaces. This is a normal occurrence and is not an indication of microwave leakage or a malfunction.



## INSTALLATION

1. Remove all packing materials from the inside of the oven cavity. Discard the loose polythene sheet from between the door and cavity. Remove the feature sticker, if attached, from the outside of the door.

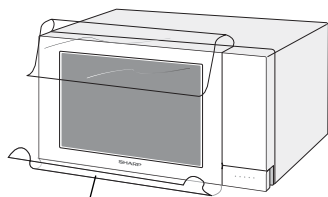

✓ Remove this film

2. Check the oven carefully for any signs of damage.
3. Place the oven on a flat, level surface strong enough to support the oven's weight plus the heaviest item likely to be cooked.

4. **The oven door may become hot during cooking. Place or mount the oven so that the bottom of the oven is 85 cm or more above the floor. Keep children away from the door to prevent them burning themselves.**

5. **Do not allow the power supply cord to run over any hot or sharp surfaces, such as the hot air vent area at the top rear of the oven.**

6. Ensure there is a minimum of free space above the oven of 20 cm.

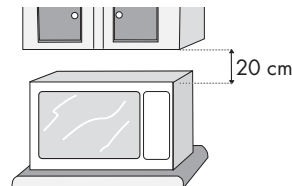

7. Securely connect the plug of the oven to a standard earthed (grounded) household electrical outlet.



## BEFORE OPERATION



Your oven comes pre-set for Energy Save Mode so when you first plug it in nothing will appear on the digital display.

### To operate the oven in Energy Save Mode:

1. Plug in the oven. Nothing will appear on the display at this time.
2. Open the door.  
The oven display will show “.0”.
3. Close the door.
4. Heat the oven without food (See page 11).

### NOTE:

You can change to Clock Set Mode if you prefer, see page 8 of the operation manual. If you decide to set the clock, Energy Save Mode does not work.

In Energy Save Mode, if you do not operate the oven for 2 minutes or more (i.e. closing the door, pressing the **STOP** key, or at the end of cooking), you will not be able to operate the oven until you open and close the oven door.

## ENERGY SAVE MODE



Your oven has two operating modes, Energy Save Mode and Clock Set Mode.

The difference between them is that when you are not using the oven, in Energy save Mode nothing will appear on the digital display and in Clock Set Mode the time will be shown.

In Energy Save Mode, if you do not operate the oven for 2 minutes or more (i.e. closing the door, pressing the **STOP** key, or at the end of cooking), you will not be able to operate the oven.

To restore power on, open the door.

### If you set the clock, energy save mode will be cancelled.

To start energy save mode manually, follow the instructions below.

### Example:

To start the energy save mode, (the current time is 23:35):

1. Make sure the correct time appears on the display.
2. Press the **CLOCK** button once.
3. Adjust the display to 0 by rotating the **TIME/WEIGHT** dial.
4. Press **START** +1 min button. The power will be off and the display will show nothing.

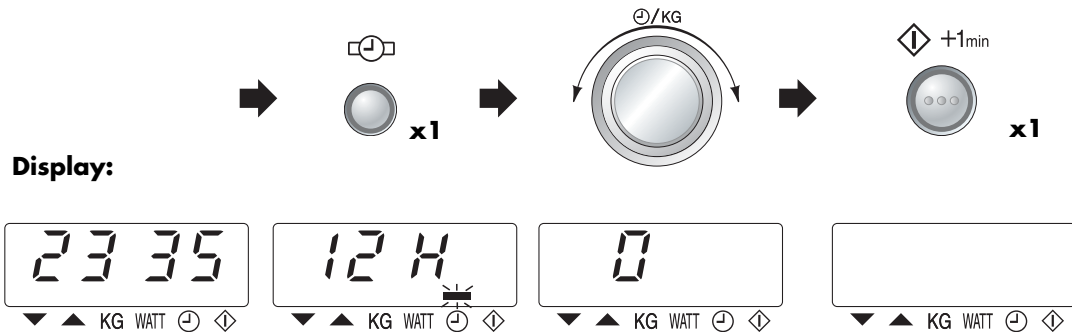



## SETTING THE CLOCK

There are two setting modes: 12 hour clock and 24 hour clock.

- 1.** To set the 12 hour clock, press the **CLOCK** button once, as shown:

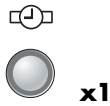

- 2.** To set the 24 hour clock, press the **CLOCK** button twice, as shown:

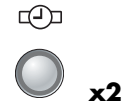

### Example:

To set the 24 hour clock to 23:35:

- 1.** Choose the 24 hour clock by pressing the **CLOCK** button twice.

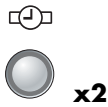

- 2.** Set the hours. Rotate the **TIME/WEIGHT** dial clockwise until the correct hour is displayed.

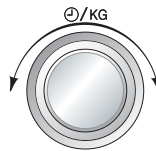

- 3.** Change from hours to minutes by pressing the **CLOCK** button once.

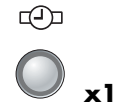

- 4.** Set the minutes.

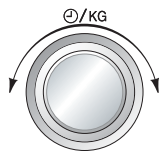

- 5.** Start the clock.

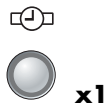

### Check the display.



### NOTES:

- You can rotate the **TIME/WEIGHT** dial clockwise or counter clockwise.
- Press the **STOP** button if you make a mistake during programming.
- If the oven is in cooking mode and you wish to know the time of day, touch the **CLOCK** button. As long as your finger is touching the button, the time of day will be displayed.
- If the electrical power supply to your microwave oven is interrupted, plug in the oven again, then open and close the door. The display will show: ".0".

- If this occurs during cooking, the programme will be erased. The time of day will also be erased.
- When you want to reset the time of day, follow the above example again.
- If you do not set the clock, press the **STOP** button once. ".0" will appear on the display. When the operation of the oven is finished, ".0" will reappear on the display instead of the time of day.
- If you set the clock, energy save mode does not work.



## USING THE STOP BUTTON

STOP



Use the **STOP** button to:

- Erase a mistake during programming.
- Stop the oven temporarily during cooking.
- Cancel a programme during cooking, press the **STOP** button twice.

## MICROWAVE POWER LEVELS



Your oven has 5 power levels. To choose the power level for cooking, follow the advice given in the recipe section. Generally the following recommendations apply:

**800 WATT (800 P) 100 %** used for fast cooking or reheating e.g. soup, casseroles, canned food, hot beverages, vegetables, fish, etc.

**560 WATT (560 P) 70 %** used for longer cooking of dense foods such as roast joints, meat loaf and plated meals, also for sensitive dishes such as cheese sauce and sponge cakes. At this reduced setting, the sauce will not boil over and food will cook evenly without over cooking at the sides.

### P = POWER

- To select Microwaving, rotate the **COOKING MODE** dial to the  MICROWAVE setting.
- Select the desired microwave power setting by pressing the **WATT** button.
- If the **WATT** button is pressed once, 800P (100 %) will be displayed.  
If you miss your desired level, continue pressing the **WATT** button until you reach the level again.
- **If the level is not selected, the level 800P (100 %) is automatically set.**

**400 WATT (400 P) 50 %** for dense foods which require a long cooking time when cooked conventionally, e.g. beef dishes, it is advisable to use this power setting to ensure the meat will be tender.

**240 WATT (240 P) 30 %** (Defrost setting) to defrost, select this power setting, to ensure that the dish defrosts evenly. This setting is also ideal for simmering rice, pasta, dumplings and cooking egg custard.

**80 WATT (80 P) 10 %** For gentle defrosting, eg. cream gateaux or pastry.



## MICROWAVE COOKING

Your oven can be programmed for up to 90 minutes. (90.00). The input unit of cooking (defrosting) time varies from 10 seconds to five minutes. It depends on the total length of the cooking (defrosting) time as shown on the table opposite:

Cooking Time:	Increasing unit:
0-5 minutes	10 seconds
5-10 seconds	30 seconds
10-30 minutes	1 minute
30-90 minutes	5 minutes

### Example:

Suppose you want to heat soup for 2 minutes and 30 seconds on 560 W microwave power.

1. Rotate the **COOKING MODE** dial to the MICROWAVE setting.
2. Press the **WATT** button twice for 560 W microwave power.
3. Enter desired cooking time by rotating the **TIME/WEIGHT** dial clockwise.
4. Press the (**START**) +1 min button once to start cooking.

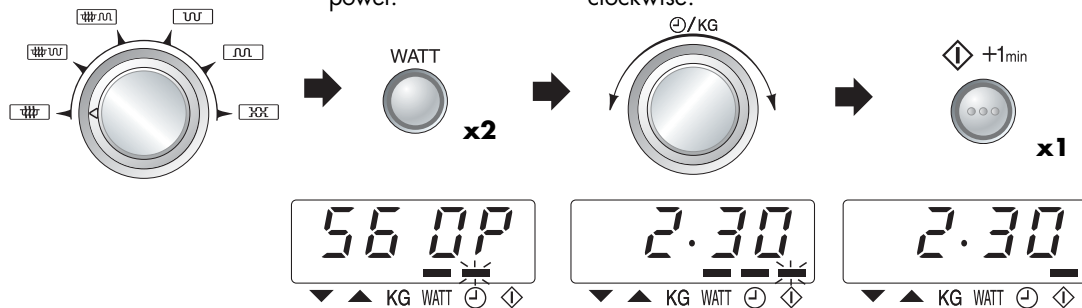

### NOTES:

1. When the door is opened during the cooking process, the cooking time on the digital display stops automatically. The cooking time starts to count down again when the door is closed and the (**START**) +1 min button is pressed.
2. If you wish to know the power level during cooking, press the **WATT** button.
3. As long as your finger is pressing the **WATT** button, the power level will be displayed.
4. You can rotate the **TIME/WEIGHT** dial clockwise or counter-clockwise. If you rotate the dial counter-clockwise, the cooking time will decrease from 90 minutes by degrees.
5. If you have not used the oven for over 2 minutes, open and shut the door before programming.



## GRILL COOKING

Your oven has 2 grill heating elements, and a combination of 3 grill cooking modes.

Select the desired grill mode by rotating the **COOKING MODE** dial to the desired setting.

COOKING MODE DIAL	GRILL HEATING ELEMENT IN USE
	Top Grill
	Bottom Grill
	Top and Bottom Grill together

## GRILL COOKING



### Example:

Suppose you want to cook cheese on toast for 5 minutes using the top grill only: (Place toast on the rack.)

1. Rotate the **COOKING MODE** dial to the **TOP GRILL** setting.
2. Enter the desired cooking time by rotating the **TIME/WEIGHT** dial clockwise.
3. Press the **(START) +1min** button to start cooking.

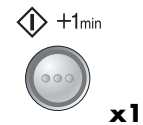
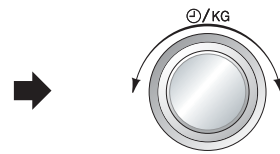
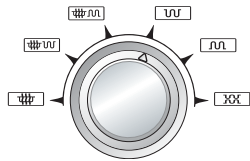

Display:

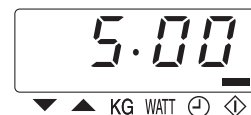
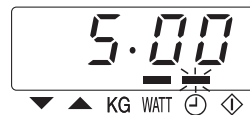

1. The rack is recommended when grilling.
2. You may detect smoke or a burning smell when using the grill for the first time, this is normal and not a sign that the oven is out of order. (Please see heating without food below.)
3. After cooking using TOP GRILL and BOTTOM GRILL **Hot** the display may show 'Hot'.

**WARNING: The oven cavity, door, outer cabinet, turntable, rack, dishes and especially the bottom grill will become very hot, always use thick oven gloves when removing the food or turntable from the oven to prevent burns.**

## HEATING WITHOUT FOOD



You may detect smoke or a burning smell when using the grill(s) or dual grill for the first time. This is normal and not a sign that the oven is out of order.

To avoid this problem, when first using the oven, operate both top and bottom grills without food for 20 minutes.

**IMPORTANT:** During grill operation, to allow smoke or smells to disperse open a window or switch the kitchen ventilation on. Make sure there is no food in the oven.

1. Rotate the **COOKING MODE** dial to the **TOP & BOTTOM GRILL** setting.
2. Enter the required heating time. (20 min.)
3. Start cooking by pressing the **(START) +1min** button.
4. The oven will count down. When the oven has finished cooking, open the door to cool the oven cavity.

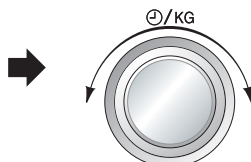
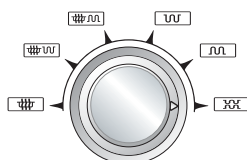

**WARNING: The oven door, outer cabinet & oven cavity will become hot. Take care to avoid burns when cooling the oven down after operation.**



## DUAL COOKING

Your oven has 2 **DUAL** cooking modes to combine the Microwave with the Grill(s). To select the **DUAL** cooking mode, rotate the **COOKING MODE** dial to the desired setting. Generally, dual cooking time shortens the total cooking time.

Setting	COOKING MODE dial	Initial Microwave power	Grill heating element
DUAL 1 		240 W	Top grill
DUAL 2 		240 W	Bottom grill

\* If you want to adjust the microwave power, press the **WATT** button. You can select up to 800 W power.

### Example:

Suppose you want to cook for 20 minutes on DUAL 1, combining 80 W (10 %) with the TOP GRILL:

1. Rotate the **COOKING MODE** dial to the setting, combining microwaving with the TOP GRILL.
2. Press the **WATT** button twice for 80 W microwave power.
3. Enter the desired cooking time by rotating the **TIME/WEIGHT** dial clockwise.
4. Press the (**START**) +1 min button to start cooking.

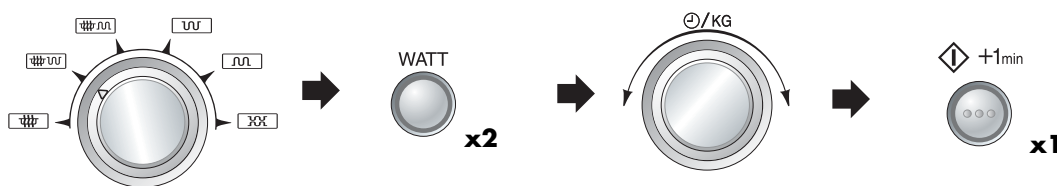

### Display:



**NOTE:** After cooking, the display may show "Hot".

**WARNING:** The oven cavity, door, outer cabinet, turntable, rack, dishes and especially the bottom grill will become very hot, always use thick oven gloves when removing the food or turntable from the oven to prevent burns.

## OTHER CONVENIENT FUNCTIONS



### 1. LESS / MORE button.

The **LESS** (▼) and **MORE** (▲) buttons allow you to easily decrease or increase programmed setting times, (for a less well or more well cooked result), used in automatic operations or cooking time while in operation.

#### a) Changing the pre-programmed time setting.

##### Example:

Suppose you want to cook 0.9 kg Grilled Chicken using the **AUTO COOK** button and **MORE** (▲) button.

1. Select **AUTO COOK** (Grill Chicken) by pressing the **AUTO COOK** button 4 times. The **AUTO** indicator light will come on.
2. Enter the amount by rotating the **TIME/WEIGHT** dial clockwise.
3. Choose the desired result (well cooked) by pressing the **MORE** (▲) button once.
4. Press the **START** +1min button to start cooking.

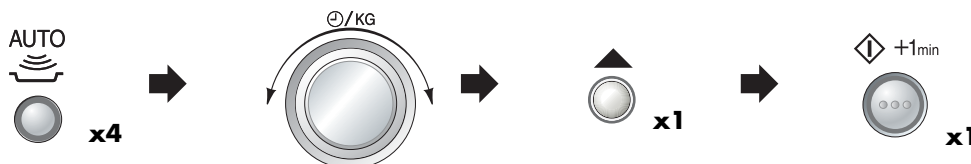

##### Display:

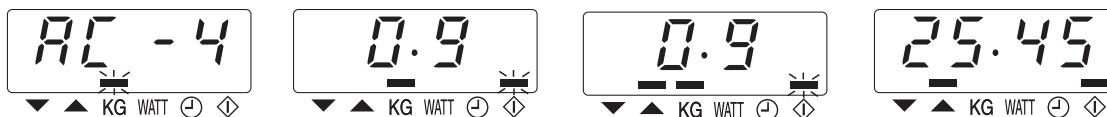

##### NOTE:

To cancel **LESS** or **MORE**, press the same button again.

To change **MORE** to **LESS** simply press the **LESS** (▼) button.

To change **LESS** to **MORE** simply press the **MORE** (▲) button.

#### b) Adjusting the heating time while oven is operating.

The cooking time can be decreased or increased in 1 minute steps each time the **LESS** (▼) and **MORE** (▲) buttons are pressed.

**NOTE:** You can use this function for manual cooking only.



## OTHER CONVENIENT FUNCTIONS

### 2. MINUTE PLUS function.

The  (**START**) +1min button allows you to operate the two following functions:

#### a) 1 minute cooking

You can cook on your desired cooking mode for 1 minute without entering the cooking time.

##### Example:

Suppose you want to cook for 1 minute at 400 W (50 %) microwave power.

1. Rotate the **COOKING MODE** dial to the  MICROWAVE setting.

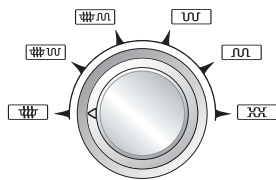

2. Press the **WATT** button 3 times for 400 W microwave power.





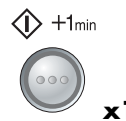

3. Press the  (**START**) +1min button to start cooking.



Display:



#### NOTE:

1. You can use this function for manual cooking only.
2. When the **COOKING MODE** dial is on microwave () and you press the  (**START**) +1min button, the microwave power is always 800 W. When the **COOKING MODE** dial is on dual () or ) and you press the  (**START**) +1min button, the microwave power is always 240 W.
3. To avoid misuse by children the **1 minute cooking** function can be used only within 3 minutes after the preceding operation, ie closing the door or pressing the **STOP** button.

#### b) Extend the cooking time

You can extend the cooking time in multiples of one minute if the button is pressed while the oven is in operation.

**NOTE:** You can use this function for manual cooking only.

### 3. TO CHECK THE POWER LEVEL

To check the microwave power level during cooking press the **WATT** button.



As long as your finger is pressing the **WATT** button, the power level will be displayed. The oven continues to count down, although the display shows the power level.



## AUTOMATIC OPERATION



These functions automatically work out the correct cooking mode and cooking time to get the best results. You can choose from the 3 PIZZA, 7 AUTO COOK and 2 AUTO DEFROST menus.

**PIZZA** button



**AUTO COOK** button



**AUTO DEFROST** button



**WARNING: For all menus except AUTO DEFROST:**

The oven cavity, door, outer cabinet, turntable, rack, dishes and especially the bottom grill will become very hot. Use thick oven gloves when removing food or the turntable from the oven to prevent burns.

What you need to know when using these automatic functions:

1. Menu can be input by pressing the **PIZZA**, **AUTO COOK** or **AUTO DEFROST** button until the desired menu number is displayed.
2. The weight of the food can be input by rotating the **TIME/WEIGHT** dial until the desired weight is displayed.  
Enter the weight of the food only. Do not include the weight of the container.  
For food weighing more or less than weights/quantities given in the cooking chart, cook using manual operation.
3. The programmed cooking times are average times. If you want to alter cooking times pre-programmed in the automatic operations, use the **LESS (▼)** or **MORE (▲)** buttons. For best results follow the cooking chart instructions, pages 16 - 18.
4. Press the **◇ (START) +1 min** button to start cooking.

When action is required (e.g. to turn food over) the oven stops, the audible signals sound and the display shows the necessary action. To continue cooking, press the **◇ (START) +1 min** button.

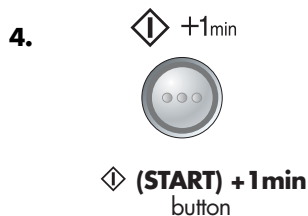
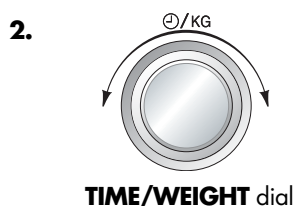
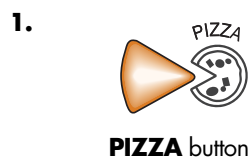

The final temperature will vary according to the initial temperature. Check food is piping hot after cooking. If necessary, you can extend the cooking time and change the power level.



## AUTOMATIC OPERATION

The **PIZZA**, **AUTO COOK** and **AUTO DEFROST** buttons offer the possibility to cook foods quickly and easily.

**Example:** Suppose you want to cook Roast Pork weighing 1,0 kg using the **AUTO COOK** button.



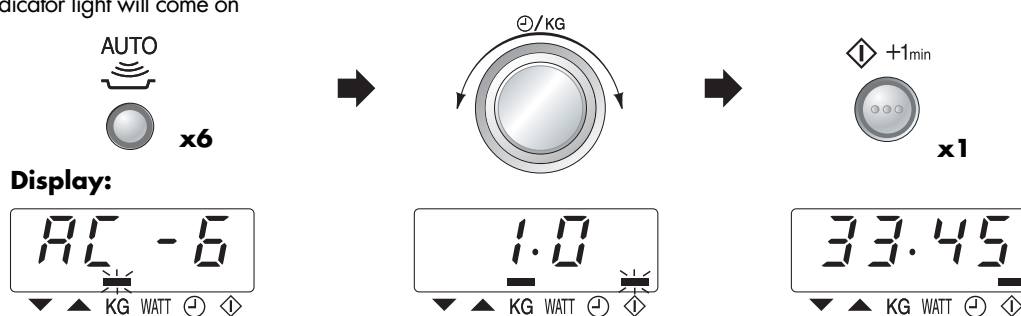



1. Choose the AUTO COOK menu AC-6 by pressing the **AUTO COOK** button 6 times. The weight indicator will flash on the display and the AUTO indicator light will come on
2. Enter the weight by rotating the **TIME/WEIGHT** dial clockwise.
3. Press the **START** (+1min) button to start cooking.



**NOTE:** After cooking (except Auto defrost), the display may show "Hot".



## PIZZA CHART

BUTTON	MENU	WEIGHT (Increasing Unit) / UTENSILS	PROCEDURE
	<b>AP-1 Pizza</b> Frozen Pizza 	0,15 - 0,45 kg (50 g) (initial temp -18° C) Directly on the turntable	<ul style="list-style-type: none"> <li>Remove the ready prepared frozen pizza from the packaging and place on the turntable. For thick base pizza, press the <b>MORE (▲)</b> button.</li> <li>After cooking, place on a plate for serving.</li> </ul>
	<b>AP-2 Pizza</b> Chilled Pizza 	0,15 - 0,45 kg (50 g) (initial temp 5° C) Directly on the turntable	<ul style="list-style-type: none"> <li>Remove the ready prepared chilled pizza from the packaging and place on the turntable.</li> <li>After cooking, place on a plate for serving.</li> </ul>
	<b>AP-3 Pizza</b> Fresh Pizza e.g. Homemade Pizza 	0,7 - 0,9 kg (100 g) (initial temp 20° C) Directly on the turntable	<ul style="list-style-type: none"> <li>Prepare the pizza following the recipe below.</li> <li>Place directly on the turntable.</li> <li>After cooking, place on a plate for serving.</li> </ul>

### PIZZA RECIPE

Ingredients:

- 300 g Approx. Ready prepared dough  
(Ready mix or roll out dough.)
- 200 g Approx. Tinned tomatoes
- 150 g Topping as desired  
(e.g. corn, ham, salami, pineapple)
- 50 g Grated cheese  
Basil, oregano, thyme  
salt, pepper

Procedure:

1. Prepare the dough according to the manufacturer's instructions. Roll out to the size of the turntable.
2. Lightly grease the turntable and place the pizza base on it and pierce the dough.
3. Drain the tomatoes and cut them into pieces. Season the tomatoes with the spices and spread on the dough. Put all other ingredients on the pizza and finally cover with the cheese.
4. Cook on **AP-3 Pizza** "Fresh Pizza".

## AUTO COOK CHART



BUTTON	MENU	WEIGHT (Increasing Unit) / UTENSILS	PROCEDURE
AUTO  x1	<b>AC-1 Cook</b> French Fried Potatoes (recommended for conventional ovens) e.g Standard and thick type	0,2 - 0,3 kg (50 g) (initial temp -18° C) Directly on the turntable	<ul style="list-style-type: none"> <li>Remove the deep frozen French fried potatoes from the packaging and place on the turntable.</li> <li>For thick French fried potatoes, use the <b>MORE (▲)</b> button.</li> <li>After cooking, place on a plate for serving.</li> </ul>
AUTO  x2	<b>AC-2 Cook</b> Frozen Baguettes e.g. Baguettes with Pizza topping	0,15 - 0,4 kg (50 g) (initial temp -18° C) Directly on the turntable	<ul style="list-style-type: none"> <li>Remove the deep frozen baguettes from the packaging and place on the turntable.</li> <li>After cooking, place on a plate for serving.</li> </ul>
AUTO  x3	<b>AC-3 Cook</b> Fish Fingers, Poultry meat pieces (e.g. Chicken Nuggets)	0,2 - 0,4 kg (50 g) (initial temp -18° C) Directly on the turntable	<ul style="list-style-type: none"> <li>Remove the deep frozen fish fingers from the packaging and place on the turntable.</li> <li>After cooking, place on a plate for serving.</li> </ul>
AUTO  x4	<b>AC-4 Cook</b> Grilled Chicken  Ingredients for 1,0 kg grilled chicken: 1/2 tsp Salt and Pepper, 1 tsp sweet paprika, 2 tbsp oil	0,9 - 1,4 kg (100 g) (initial temp 5° C) Flan dish Saucer	<ul style="list-style-type: none"> <li>Mix the ingredients and spread on the chicken.</li> <li>Pierce the skin of the chicken with a fork.</li> <li>Place a saucer upside down in a flan dish and place the chicken on the saucer.</li> <li>When audible signals sound, turn the chicken over.</li> <li>After cooking, leave for approx. 3 minutes in the oven, remove and put on a plate for serving.</li> </ul>
AUTO  x5	<b>AC-5 Cook</b> Gratinated Fish Fillet	0,6 - 1,2 kg* (100 g) (initial temp 5° C) Gratin dish	<ul style="list-style-type: none"> <li>See recipes for Gratinated Fish Fillet on page 19.</li> <li>* Total weight of all ingredients.</li> </ul>
AUTO  x6	<b>AC-6 Cook</b> Roast Pork  Ingredients for 1,0 kg rolled lean pork: 1 garlic clove, crushed, 2 tbsp oil, 1 tsp sweet paprika, a little cumin powder 1 tsp salt	0,6 - 1,5 kg (100 g) (initial temp 5° C) Flan dish	<ul style="list-style-type: none"> <li>Lean roast pork is recommended.</li> <li>Mix all ingredients and spread on the pork.</li> <li>Place the pork in a flan dish on the turntable.</li> <li>When audible signals sound, turn the food over.</li> <li>After cooking, let the food stand wrapped in aluminium foil for approx. 10 minutes.</li> </ul>
AUTO  x7	<b>AC-7 Cook</b> Grill Skewers See recipes on page XX.	0,2 - 0,6 kg (100 g) (initial temp 5° C) Rack	<ul style="list-style-type: none"> <li>Prepare the grill skewers.</li> <li>Place on the rack and cook.</li> <li>When the audible signal sounds turn over.</li> <li>After cooking, place on a plate for serving.</li> </ul>



## AUTO DEFROST CHART

BUTTON	MENU	WEIGHT (Increasing Unit) / UTENSILS	PROCEDURE
	<b>Ad-1 Defrost</b> Poultry	0,9 - 1,5 kg (100 g) (initial temp -18° C) (See note below for utensils)	<ul style="list-style-type: none"> <li>Put a plate up side down on the turntable and place the poultry on it.</li> <li>When audible signal sounds, turn over.</li> <li>When audible signal sounds, turn over again.</li> <li>After defrosting, let stand wrapped in aluminium foil for 30-90 minutes, until thoroughly defrosted.</li> </ul>
	<b>Ad-1 Defrost</b> Chicken Legs	0,2 - 0,8 kg (100 g) (initial temp -18° C) (See note below for utensils)	<ul style="list-style-type: none"> <li>Put the chicken legs on a plate.</li> <li>When the audible signal sounds, turn the chicken legs over and re-arrange.</li> <li>When the audible signal sounds, turn the chicken legs over again.</li> <li>After defrosting, let the chicken stand, wrapped in aluminium foil for 10-30 minutes, until it has thoroughly defrosted.</li> </ul>
	<b>Ad-1 Defrost</b> Steak, Chops and Fish Fillets	0,2 - 0,8 kg (100 g) (initial temp -18° C) (See note below for utensils)	<ul style="list-style-type: none"> <li>Position the food on a plate in a single layer with thinner parts to the centre. If portions are frozen together, try to separate before defrosting.</li> <li>When the audible signal sounds, turn the food over and re-arrange.</li> <li>When the audible signal sounds turn the food over again.</li> <li>After defrosting, let the food stand, wrapped in aluminium foil for 10-30 minutes, until it has thoroughly defrosted.</li> </ul>
	<b>Ad-2 Defrost</b> Meat Joint	0,6 - 1,5 kg (100 g) (initial temp -18° C) (See note below for utensils)	<ul style="list-style-type: none"> <li>Position a plate upside down on the turntable and place the meat on it.</li> <li>When the audible signal sounds, turn the meat joint over.</li> <li>When the audible signal sounds, turn the meat joint over again.</li> <li>After defrosting, let the food stand, wrapped in aluminium foil for 30-90 minutes, until it has thoroughly defrosted.</li> </ul>

**NOTES:**

- Steaks, Chops, Fish fillets and Chicken legs should be frozen in one layer.
- After turning the food over, shield the defrosted portions with small, flat pieces of aluminium foil.
- The poultry should be cooked immediately after defrosting.
- Arrange the food in the oven as shown below:

Chicken legs, Steaks, Chops and Fish fillets.

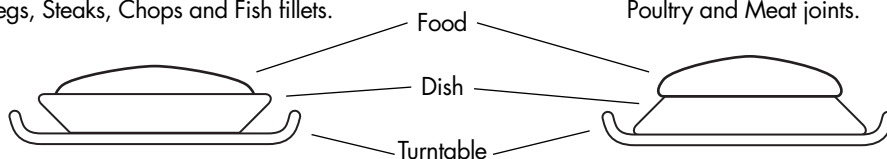

Poultry and Meat joints.

## RECIPES FOR AUTO COOK AC-5



### GRATINATED FISH FILLET (AC-5)

#### Fish Gratin Italian Style

Ingredients: 600 g Rose Fish Fillet  
250 g Mozzarella. approx  
250 g tomatoes  
2 tbsp. anchovy butter  
salt and pepper  
1 tbsp chopped basil  
lemon juice of 1/2 lemon  
2 tbsp chopped mixed herbs  
75 g grated Gouda (45 % fat)  
sauce thickening powder

#### Procedure:

- Wash the Fish and dry. Sprinkle with lemon juice and salt and grease with the anchovy butter.
- Place in a round gratin dish (25 cm).
- Sprinkle the gouda over the fish.
- Wash the tomatoes and remove the stalks. Cut into slices and place on top of the cheese.
- Season with salt, pepper and the mixed herbs.
- Drain the mozzarella, cut into slices and place on the tomatoes. Spread over the basil.
- Place the gratin dish on the turntable and cook on **AUTO COOK AC-5** "Gratinated Fish Fillet" (1,2 kg).

Hint: After cooking remove the fish from the gratin dish and stir in some sauce thickening powder. Cook again for 1-2 minutes on 800 W power.

### GRATINATED FISH FILLET (AC-5)

#### Gratinated Rose Fish Fillets 'Esterhazy'

Ingredients: 600 g Rose Fish Fillet  
250 g Leeks  
50 g onion  
100 g carrot  
1 tbsp. butter  
salt, pepper and nutmeg  
2 tbsp. lemon juice  
125 g crème fraîche  
100 g grated Gouda (45 % fat)

#### Procedure:

- Wash the leeks and divide in 2 parts from top to bottom. Cut into thin strips.
- Peel the onions and carrots and cut into thin strips.
- Put the vegetables, butter and spices into a casserole dish and mix well. Cook for 5-6 minutes on 800 W power. Stir once in-between cooking.
- In the meantime wash the fish fillet, dry and sprinkle with lemon juice and salt.
- Mix the Crème fraîche under the vegetables and season again.
- Put half of the vegetables in a round gratin dish (25 cm). Place the fish on top and cover with the remaining vegetables.
- Spread over the Gouda and place on the turntable. Cook on **AUTO COOK AC-5** "Gratinated Fish Fillet" (1,2 kg).

### GRATINATED FISH FILLET (AC-5)

#### Gratinated Rose Fish - Broccoli.

Ingredients: 500 g Rose Fish Fillet  
2 tbsp. lemon juice  
1 tbsp. butter  
2 tbsp flour  
300 ml milk  
chopped dill, pepper and salt  
250 g frozen broccoli  
100 g grated Gouda (45 % fat)

#### Procedure:

- Wash the fish fillet and dry. Sprinkle with lemon juice and salt.
- Heat together butter and flour in a casserole dish without cover for 1-1½ mins on 800 W power.
- Add the milk and stir well. Cook again without cover for 3-4 minutes on 800 W power. After cooking stir and season with dill, salt and pepper.
- Defrost the broccoli in a casserole dish for 4-6 mins on 800 W power. Once defrosted, place the broccoli into a round gratin dish (25 cm) and put the fish on top and season.
- Pour the sauce over and sprinkle over the cheese
- Place on the turntable and cook on **AUTO COOK AC-5** "Gratinated Fish Fillet" (1,1 kg).



## CARE AND CLEANING

**CAUTION: DO NOT USE COMMERCIAL OVEN CLEANERS, ABRASIVE, HARSH CLEANERS OR SCOURING PADS ON ANY PART OF YOUR MICROWAVE OVEN.**

**WARNING!**

**After GRILL, DUAL and AUTOMATIC operation (except Auto Defrost) modes, the oven cavity, door, oven cabinet and accessories will become very hot. Before cleaning, make sure they have cooled down.**

### Oven exterior

The outside of your oven can be cleaned easily with mild soap and water. Make sure the soap is wiped off with a moist cloth, and dry the exterior with a soft towel.

### Oven controls

Open the door before cleaning to de-activate the oven controls. Care should be taken when cleaning the oven control. Using a cloth dampened with water only, gently wipe the panel until it becomes clean. Avoid using excessive amounts of water. Do not use any sort of chemical or abrasive cleaner.

### Oven Interior

1. For cleaning, wipe any splatters or spills with a soft damp cloth or sponge after each use while the oven is still warm. For heavier spills, use a mild soap and wipe several times with a damp cloth until all residues have been removed. Do not remove the waveguide cover.
2. Make sure that mild soap or water does not penetrate the small vents in the walls which may cause damage to the oven.
3. Do not use spray type cleaners on the oven interior. Do not use a steam cleaner.
4. Heat up your oven regularly by using both heating elements, refer to "Heating without food" on page 11. Remaining food or fat splashed on the oven interior can cause smoke or a bad smell.

### Turntable

Remove the turntable. Wash the turntable in mild soapy water. Dry with a soft cloth. The turntable is dishwasher safe.

### Rack

The rack should be washed in a mild washing up liquid solution and dried. The rack is dishwasher safe.

### Door

To remove all trace of dirt, regularly clean both sides of the door, the door seals and adjacent surfaces with a soft, damp cloth.

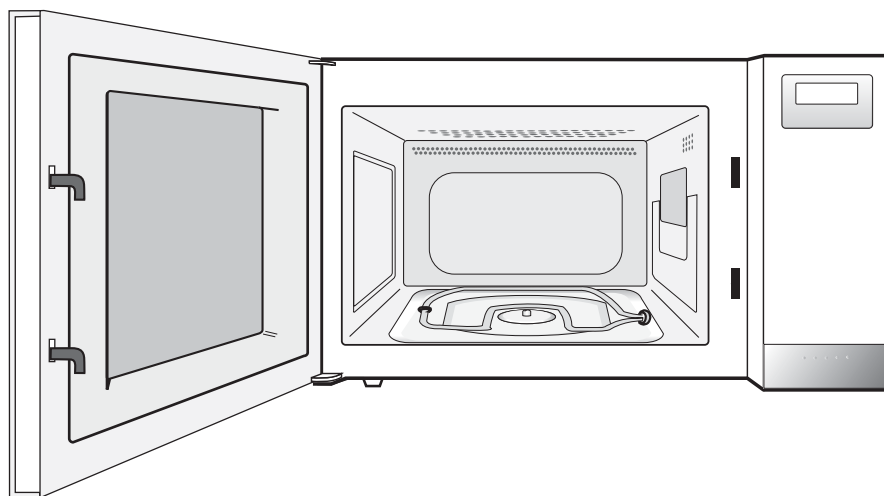

## SERVICE CALL CHECK



**PLEASE CHECK THE FOLLOWING BEFORE CALLING FOR SERVICE:**

1. Power Supply:  
 Check the power plug is properly connected to a suitable wall outlet.  
 Check the line fuse/circuit breaker is functioning properly.
2. When the door is opened, does the oven lamp turn on? YES \_\_\_\_\_ NO \_\_\_\_\_
3. Place a cup of water (approx. 150 ml) in the oven and close the door securely.  
 Set the **COOKING MODE** dial to microwave setting.  
 Programme the oven for one minute on 800 W power and start the oven.  
 Does the oven lamp come on? YES \_\_\_\_\_ NO \_\_\_\_\_  
 Does the turntable rotate? YES \_\_\_\_\_ NO \_\_\_\_\_  
**NOTE:** The turntable turns in either direction.  
 Does the ventilation work? YES \_\_\_\_\_ NO \_\_\_\_\_  
 (Place your hand over the ventilation openings and check for air flow.)  
 After 1 minute does the signal sound? YES \_\_\_\_\_ NO \_\_\_\_\_  
 Does the cooking in progress indicator go off? YES \_\_\_\_\_ NO \_\_\_\_\_  
 Is the cup of water warm after the above operation? YES \_\_\_\_\_ NO \_\_\_\_\_
4. Set the **COOKING MODE** dial to the TOP & BOTTOM GRILL setting for 3 minutes. After 3 minutes do both GRILL heating elements become red? YES \_\_\_\_\_ NO \_\_\_\_\_

If you answer "NO" to any of the above questions, call a Service Technician appointed by SHARP and report the results of your check. See inside back cover for details of address.

**IMPORTANT:** If the display shows nothing even if the power plug is properly connected, the energy save mode should carry on. To release it, open the oven door. See page 7.

**NOTE:**

1. If you cook the food over the standard time with only the same cooking mode, the power of the oven will lower automatically to avoid overheating. (The microwave power level will be reduced and the grill heating elements will begin to light on and off.)

Cooking mode	Standard time
Microwave 800 W cooking	20 min.
Grill cooking	
TOP GRILL	30 min.
BOTTOM GRILL	45 min.
TOP and BOTTOM GRILL	Top grill - 15 min. Bottom grill - 15 min.
Dual 1	Micro - 20 min. Top grill - 15 min.
Dual 2	Micro - 20 min. Bottom grill - 15 min.

2. After the GRILL (using both heating elements), DUAL and AUTOMATIC OPERATION (except AUTO DEFROST), the cooling fan will run and "Hot" will appear on the display. Also, when you press the **STOP** button and open the door during the GRILL, DUAL and/or automatic cooking (except AUTO DEFROST), the cooling fan will run; you may, therefore, feel air blowing from the ventilation openings.

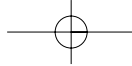

## SERVICE ADDRESSES

### ÖSTERREICH

Bei einer Reklamation Ihrer SHARP Mikrowelle wenden Sie sich bitte an Ihren Fachhändler oder an eine der nachfolgend aufgeführten SHARP SERVICE Niederlassungen.

**Manfred Mayer GmbH**, Stipcakgasse 6, 1234 Wien, Phone: 01-6093120, Fax: 01-6993629 / **MCL-Service 'GmbH**, Deutschstr. 19, 1232 Wien, Phone: 01-6168800, Fax: 01-6168800-15 / **Karl Rother**, Simmeringer Hauptstr. 11, 1110 Wien, Phone: 01-7498432, Fax: 01-7498432-12 / **Roland Göschl**, Bayerhamerstr. 12c, 5020 Salzburg, Phone: 662-882307, Fax: 662-881926 / **Franz Schuhmann**, Gablonzerweg 18, 4030 Linz, Phone: 732-382280, Fax: 732-382280-8 / **Arnold Moser**, An der Heufurt 28, 6900 Bregenz, Phone: 5574-75777, Fax: 5574-75777 / **Anton Reitmeir**, Leopoldstr. 57, 6020 Innsbruck, Phone: 512-562277, Fax: 512-562277 / **Scheuermann**, Rennsteinerstr. 8, 9500 Villach, Phone: 4242-21174, Fax: 4242-21174 / **Pichler**, Am Wagrain 342, 8055 Graz, Phone: 316-291292, Fax: 316-291292 / **Audio Video Service**, Sonnengasse 13, 9020 Klagenfurt, Phone: 463-43114, Fax: 463-43113

### BELGIUM

En cas d'une réclamation concernant une four à micro-onde SHARP, nous vous prions de vous adresser à votre spécialiste ou à une adresse des SHARP Services suivantes.

Indien uw magnetron problemen geeft kunt u zich wenden tot uw dealer of een van de onderstaande Sharp service centra.

**SHARP ELECTRONICS**, Phone: 0900-10158, Web: <http://www.sharp.be>  
**AVTC**, Kleine Winkellaan 54, 1853 Strombeek-Bever, Phone: 02/2674019, Fax: 2679670,  
**ETS HENROTTE**, Rue Du Campinaire 154, 6240 Farciennes, Phone: 071/396290, Fax: 391237  
**Nouvelle Central Radio (N.C.R.)**, Rue des Joncs 15 L-1818 HOWALD Phone: 00352404078, Fax: 402085  
 Service Center Deinze, Kapellestraat, 95, 9800 DEINZE Phone: 09-386.76.67, Fax: 09-386.97.95

### NEDERLAND

Indien uw magnetron problemen geeft kunt u zich wenden tot uw dealer of naar onderstaand Sharp Service Centrum.

**SHARP ELECTRONICS BENELUX BV**, - Helpdesk -, Postbus 900, 3990 DW Houten, Telefoon: 0900-7427723,  
 Web: <http://www.sharp.nl>

### DEUTSCHLAND

Bei einer Reklamation Ihrer SHARP Mikrowelle wenden Sie sich bitte an Ihren Fachhändler oder an eine der nachfolgend aufgeführten SHARP SERVICE Niederlassungen.

**03058 Groß Garglow**, Cottbuser Str.129, Bernd Mindach, Tel: 0355-539987, Fax: 0355-5265685 / **04159 Leipzig**, Max-Liebermann-Straße 4 a, Rudi Franz, Tel: 0341-9112525, Fax: 0341-9112526 / **04600 Altenburg**, Wallstr. 35, Mechanik Altenburg E.G., Tel: 03447-311102, Fax: 03447-315253 / **06217 Merseburg**, Gotthardstraße 30, Looke & May GmbH, Tel: 03461-214121, Fax: 03461-216891 / **06295 Eisleben**, Hallesche Straße 36, Hausger. Kundend. Eisleben, Tel: 03475-603079, Fax: 03475-747262 / **06618 Naumburg**, Wenzelstraße 15, Hausgeräte & Service GmbH, Tel: 03445-202016, Fax: 03445-202016 / **06844 Dessau**, Albrechtstraße 116-118, Dessau-Electric GmbH, Tel: 0340-261270, Fax: 0340-213332 / **07407 Rudolstadt**, Emil Hartmann Straße 2, Elektro Ernst Granowski, Tel: 03672-352123, Fax: 03672-357097 / **07987 Kahmer**, Dorfstraße 25, Elektro Riederer Haushaltgeräte, Tel: 03661-430142, Fax: 03661-482422 / **08280 Aue**, Juri-Gagarin-Ring 12a, EHS Hausgeräte GmbH, Tel: 03771-552222, Fax: 03771-552255 / **08523 Plauen**, Weststraße 63, Elektrotechnik Plauen GmbH, Tel: 03741-2120, Fax: 03741-212259 / **09221 Neukirchen**, Hauptstraße 74, Walther Elektro, Tel: 0371-217096, Fax: 0371-217090 / **09246 Pleiße**, Zeppelinstraße 8 a, Hans Krempel Haustechnik GmbH, Tel: 03722-73780, Fax: 03722-737822 / **09328 Lunzenau**, Schulstraße 6, Peter Welsch GmbH, Tel: 037383-6434, Fax: 037383-6448 / **09376 Oelsnitz**, Bahnhofstraße 43, Elektrotechnik Oelsnitz-GmbH, Tel: 037298-2677, Fax: 037298-2678 / **12157 Berlin**, Cranachstraße 2, Elektro-Kittler, Tel: 030-85602602, Fax: 030-85602603 / **16866 Kyritz**, Hamburgerstr. 31, Schumacher Haustechnik GmbH, Tel: 033971-54137, Fax: 033971-54137 / **17235 Neustrelitz**, Glambecker Nebenstr. 10, Dieter Kroppen, Tel: 03981-204661, Fax: 03981-204667 / **18055 Rostock**, Timmermannstrat 5, Hetec, Tel: 0381-36231, Fax: 0381-36231 / **18435 Stralsund**, Kedingshäger Straße 78, RDS Haushaltsgeräte GmbH, Tel: 03831-391426, Fax: 03831-390121 / **20357 Hamburg**, Schulterblatt 132, Dieter Möller, Tel: 040-435332, Fax: 040-4302120 / **20537 Hamburg**, Eiffestraße 398, Deubel+Höfermann Elektronik GmbH, Tel: 040-41365200, Fax: 040-41365299 / **22459 Hamburg**, Seesrein 35, Dieter A. Vollbrecht VDI Klima und Kälte Service, Tel: 040 - 5517331, Fax: 040 - 5519996 / **23562 Lübeck**, Helmholtzstraße 12, Lutz H. Boenisch, Tel: 0451-51929, Fax: 0451-56787 / **24116 Kiel**, Eckernförder Straße 93, Jürgen Skop GmbH, Tel: 0431-13038, Fax: 0431-13811 / **24357 Fleckeby**, Südring 14, Kaack Elektro-Haushaltgeräte Service GmbH, Tel: 04354-700, Fax: 04354-1311 / **24975 Husby**, Flensburger Straße 41, Günter Josten, Tel: 04634-422, Fax: 04634-723 / **25770 Hemmingstedt**, Koesliner Straße 18, Dirk Stübner Dithmarscher Hausgeräte Service, Tel: 0481-64943, Fax: 0481-64764 / **26655 Westerstede**, Südring 37, Gerhard Ahrenholtz GmbH, Tel: 04488-84770, Fax: 04488-84771 / **27404 Heeslingen**, Kirchstraße 9-11, Helmut Willenbrock Elektro-Kälte-Radio, Tel: 04281-1031, Fax: 04281-6467 / **27472 Cuxhaven**, Abschnede 198-200, Oskar Wieand & Sohn OHG, Tel: 04721-568811, Fax: 04721-568850 / **28207 Bremen**, Neidenburger Straße 20, Hansa Haushaltgeräte Service GmbH, Tel: 0421-492526, Fax: 0421-440932 / **29439 Lüchow**, Güldenboden 25, Elektro-Kittler, Tel: 05841-709779, Fax: 05841-709780 / **30926 Seelze**, Lange-Feld-Straße 122, Strickling Werkskundendienst, Tel: 0511-4003999, Fax: 0511-40039920 / **34123 Kassel**, Heinrich-Hertz-Straße 9, KälteDienst v. Rappard, Tel: 0561-5809545, Fax: 0561-5809570 / **34128 Kassel**, Ahnatalstraße 84, Elektro Mohrhenn, Tel: 0561-61727, Fax: 0561-65470 / **35037 Marburg**, Wilhelmstraße 16, Hans-Georg Fuchs, Tel: 06421-22424, Fax: 06421-27549 / **35415 Pohlheim**, Ludwigstraße 13-15, Jung KDZ, Tel: 06403-61131, Fax: 06403-62151 / **36088 Hünfeld**, Hauptstr. 22, Elektro Vogt, Tel: 06652-2215, Fax: 06652-5782 / **37671 Hötter**, Krämerstraße 8, Elektro Nonn, Tel: 05271-7959, Fax: 05271-35053 / **39171 Altenwedding**, Friedensstr.25, Spiske IEM Installation-Elektronik-Montage, Tel: 039205-21279, Fax: 039205-80288 / **40476 Düsseldorf**, Rother Straße 21, Horst Leven, Tel: 0211-486025, Fax: 0211-443399 / **41065 Mönchengladbach**, Gutenbergstraße 28, Horst Hommers Kundendienst-Center, Tel: 02161-603256u.57, Fax: 02161-651951 / **42781 Haan**, Talstraße 8 b, Horst Kerkühn Elektro-Haustechnik, Tel: 02129-4466+53550, Fax: 02129-34037 / **45219 Essen**, Corneliusstraße 39, R. Drengenburg, Tel: 02054-84114, Fax: 02054-15238 / **46045 Oberhausen**, Feldmannstraße 76, Dieter Kroppen, Tel: 0208-871711, Fax: 0208-876652 / **48165 Münster-Hiltrup**, Rohrkampstraße 23, Günter Pfeifer Großküchentechnik, Tel: 02501-3033, Fax: 02501-24277 / **51598 Friesenhagen**, Mühlenhof 6, Hans Krempel Haustechnik GmbH, Tel: 02734-7377, Fax: 02734-40618 / **52146 Würselen**, De Gasperstraße 6+10, Hubert Hamacher, Tel: 02405-9600+9609, Fax: 02405-2704 / **55130 Mainz**, Nur telefonische Annahmestelle, Norbert Schwamb GmbH, Tel: 06131-881070 / **55543 Bad Kreuznach**, Industriestraße, Hans Krempel Haustechnik GmbH, Tel: 0671-794335, Fax: 0671-794369 / **56070 Koblenz**, August-Horch-Straße 14, Hans Krempel Haustechnik GmbH, Tel: 0261-8909173, Fax: 0261-8909199 / **57080 Siegen**, Gosenbacher Hütte 44, Hans Krempel Haustechnik GmbH, Tel: 0271-354114, Fax: 0271-351408 / **59457 Werl**, Westdahler Weg 2, MAYER Electro, Tel: 02922-3541, Fax: 02922-85382 / **63739 Aschaffenburg**, Maximilianstraße 8, Radio-Fernseh Reis, Tel: 06021-15177, Fax: 06021-15199 /

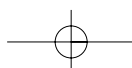



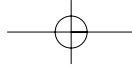

## SERVICE ADDRESSES

**65239 Hochheim**, Eltviller Straße 14, Norbert Schwamb GmbH, Tel: 06146-4085, Fax: 06146-4088 / **65627 Elbtal-Hangenmeilingen**, Am Ohlenrod 10, Rudi Wagner, Tel: 06436-3444, Fax: 06436-941387 / **65931 Frankfurt**, Nur telefonische Annahmestelle, Norbert Schwamb GmbH, Tel: 069-371525 / **66115 Saarbrücken**, Ludwigstr. 55-57, Edgar Reinert, Tel: 0681-9487070, Fax: 0681-9487060 / **67434 Neustadt**, Saarlandstraße 55, Hans Krempel Haustechnik GmbH, Tel: 06321-83077, Fax: 06321-83077 / **68309 Mannheim**, Heppenheimerstraße 23, Hans Krempel Haustechnik GmbH, Tel: 0621-7184611, Fax: 0621-7184618 / **68526 Ladenburg**, Am Sägewerk 2, Elektro Service Salinger, Tel: 06203-3341, Fax: 06203-16919 / **70186 Stuttgart**, Klippeneck Straße 1, Elektro Herterich Techn. Kundendienst, Tel: 0711-4687023, Fax: 0711-4687024 / **75236 Kämpfelbach**, Goethestraße 19, Horst Frei, Tel: 07232-1518, Fax: 07232-5238 / **76185 Karlsruhe**, Lotzbecksstraße 9, Electronic Service Franke, Tel: 0721-5700720-23, Fax: 0721-5700736 / **76872 Winden**, Hauptstraße 103, Hans Krempel Haustechnik GmbH, Tel: 06349-8571, Fax: 06349-3390 / **78462 Konstanz**, Nur telef. Annahmestelle, Elektro Herterich, Tel: 07531-27923 / **78737 Fluorn-Winzeln**, Schafbaumstraße 9, Edmund Schneider, Tel: 07402-482, Fax: 07402-8014 / **79650 Schopfheim**, Feldbergstraße 21, R. Grossmann, Tel: 07622-674510, Fax: 07622-61900 / **80339 München**, Schwantalerstraße 110, Kesel & Schnitt, Tel: 089-505802, Fax: 089-5021596 / **85095 Denkendorf-Zandt**, Mühlstraße 3, Elektro Pfeiffer, Tel: 08466-1319, Fax: 08466-1319 / **85609 München-Aschheim**, Waldweg 9a, Dieter Beise, Tel: 089-9034005, Fax: 089-9044859 / **86157 Augsburg**, Stadtberger Straße 67, J. Haslinger Elektro-Geräte Kundendienst, Tel: 0821-523125, Fax: 0821-526664 / **87439 Kempten**, Heiligkreuzer Straße 17, Radio Hartmann, Tel: 0831-594646, Fax: 0831-594648 / **89231 Neu-Ulm**, Gartenstraße 4, Elektrotechnik Schneider, Tel: 0731-85897, Fax: 0731-74681 / **91522 Ansbach**, Am Ring 17, Elektro Merk GmbH, Tel: 0981-89574, Fax: 0981-86715 / **90537 Feucht/Nürnberg**, Friedrich-Ebert-Straße 21, Herbert Geissler GmbH, Tel: 09128-70760, Fax: 09128-707636 / **93102 Pfatter**, Regensburger Straße 60, Franz Bernhard, Tel: 09481-90060, Fax: 09481-90061 / **94130 Obernzell**, Hameter Straße 31, Elektro Service Schurig, Tel: 08591-2400, Fax: 08591-1285 / **96052 Bamberg**, Aronstraße 2 a, Bernhard Jackl, Tel: 0951-9370245, Fax: 0951-9370247 / **97070 Würzburg**, Untere Johannergergasse 16, Radio Wels City Service GmbH, Tel: 0931-3557119, Fax: 0931-14151 / **98724 Neuhaus**, Eisfelder Straße 32, DLC Haustechnik GmbH, Tel: 03679-79060, Fax: 03679-790620 / **99096 Erfurt**, Goethestraße 14, Ernst Grüssler, Tel: 0361-3465719, Fax: 0361-3465719 / **99817 Eisenach**, Bahnhofstraße 17, Blitz Elektro-Elektronik GmbH, Tel: 03691-292930, Fax: 03691-292915

## FRANCE

**En cas de réclamation pour les fours micro-ondes SHARP, nous vous prions de vous adresser à votre spécialiste ou à l'une des stations techniques agréées SHARP suivantes :**

**A.A.V.I.**, 1, rue du Mont de Terre - 59818 Lesquin Cedex, Tél : 03.20.62.18.98 - Fax : 03.20.86.20.60 / **A.A.V.I. (Point d'Accueil)**, 9-11, rue Léon Trulin - 59000 Lille, Tél : 03.20.14.96.20 - Fax : 03.20.14.96.26 / **ATELIER ROUSSEL**, 12, Bld Flandre Dunkerque - 56100 Lorient, Tél : 02.97.83.07.41 - Fax : 02.97.87.02.36 / **BASTIA TELE VIDEO**, Immeuble Le Béarn - Av. de la libération - 20600 Bastia, Tel : 04.95.30.81.29 - Fax 04.95.30.85.23 / **C.M.T.S.**, 38, rue des Ormeaux - 75020 Paris, Tél : 01.43.70.20.00 - Fax : 01.43.70.36.46 / **ELECTRONIC SERVICE PLUS**, 5, bd LOUIS XI - ZI le Meneton - 37000 Tours, Tél : 02.47.77.90.90 - Fax : 02.47.77.90.91 / **ELECTRO SERVICE**, 21, rue de Mulhouse - B.P 122 - 68313 Illzach, Tél : 03.89.62.50.00 - Fax : 03.89.50.80.14 / **M.R.T.**, 74, Rue Albert Einstein - 72021 Le Mans Cedex, Tél : 02.43.28.52.20 - Fax : 02.43.24.93.81 / **ROSSIGNOL**, ZI du Brezet Est - 6 rue P.Boulangier - 63100 Clermont Ferrand, Tél : 04.73.98.64.64 - Fax : 04.73.92.28.79 / **S.T.E.**, 3, chemin de l'Industrie - 06110 Le Cannet Rocheville, Tél : 04.93.46.05.00 - Fax : 04.93.46.51.18 / **S.T.R. AQUITAINE**, 111, rue Bouthier - B.P 27 - 33015 Bordeaux, Tél : 05.57.80.78.07 - Fax : 05.57.80.78.08 / **S.T.V.S.**, 1, rue de la Presse - 42000 Saint Etienne, Tel : 0825.898.903 - Fax : 04.77.79.48.70 / **S.T.V.S.**, 10, chemin Saint Gobin - 69 190 Saint fons, Tél : 04.72.89.06.89 - Fax : 04.72.89.06.99 / **S.T.V.S. (point d'accueil)**, 143 av Maréchal de Saxe - Entrée : 54 rue Villeroy - 69003 Lyon, Tél : 04.78.62.07.05 - Fax : 04.78.62.13.65 / **TECH SERVICE**, 15 rue du château de ribaute - ZA ribaute 2 - 31130 Quint Fonsegrives, Tel : 05.62.57.63.90 - Fax : 05.62.57.63.99 / **TIMO VIDEO**, 131 chemin des bassins - Zone Europarc - Hameau D - 94000 Creteil, Tél : 01.43.39.08.18 - Fax : 01.43.39.08.07 / **U.N.T.D.**, 1, rue des Lourdines - 76000 Rouen, Tél : 02.35.72.28.04 - Fax : 02.35.73.18.32 / **VIDEO TECHNOLOGY**, 8, Allée de la Fontaine des Tournelles - Z.I. - 77230 Saint-Mard, Tel : 01.60.54.99.44 - Fax : 01.60.54.99.45

## ITALIA

**NEL CASO SI VERIFICASSERO PROBLEMI ALLA VOSTRA APPARECCHIATURA POTRETE RIVOLGERVI PRESSO UN NOSTRO CENTRO DI ASSISTENZA AUTORIZZATO SHARP**

**C.A.T. Di Bellone**, Via Dell'areoport, 76, 64100, Teramo, Tel: 0861415745, Fax: 0861212117 / **C.R. Elettronica**, Via Amitemnum 38, 67100, L'Aquila, Tel: 0862-321442, Fax: 0862-314323 / **Elettrovideo Snc**, Via Tiburtina V. 64, 65124, Pescara, Tel: 08552020, Fax: 085-52020 / **Riccardi Cosimo**, Via S.Stefano 51, 75100, Matera, Tel: 0835-333671, Fax: 0835-333671 / **Ld Service Di Lavano E De Biasi**, Via Viviani 2, 85100, Potenza, Tel: 0971-472578, Fax: 0971-472578 / **Cozzupoli & Crupi**, Via R. Campi Primo Tronco 103, 89126, Reggio Calabria, Tel: 0965-24022, Fax: 0965-310778 / **Ater Snc**, Via Naz.Pentimela 159/A-B, 89100, Reggio Calabria, Tel: 0965-47051, Fax: 0965-47855 / **Audiovideo Snc**, Via A. De Gasperi 44, 88018, Vibo Valentia, Tel: 0963-45571, Fax: 0963-45572 / **Battaglia Saverio**, Via C. Colombo 85, 88063, Catanzaro, Tel: 0961-33824, Fax: 0961-737337 / **Ciano Giuseppe**, Via Circonvallaz.Sud, 89029, Taurianova Rc, Tel: 0966-643483, Fax: 0966-614946 / **Lab. Tv Dei F.Lli Aiello Snc**, Via Torino 121/123, 88074, Crotona Cz, Tel: 0962-20889, Fax: 0962-24254 / **Mea Giuseppe**, Via L. Einaudi Trav.I 16, 88048, Lamezia T. (Cz), Tel: 0968-437520, Fax: 0968-437520 / **Medaglia Giolindo**, Via Torrazzo 60/62, 88063, Catanzaro Lido, Tel: 0961-31626, Fax: 0961-31626 / **S.A.T.E Di Dodaro**, Via Degli Stadi 28/F, 87100, Cosenza, Tel: 0984-482337, Fax: 0984-482337

**Se.Ri.El.Co.**, V.Delle Medaglie D'oro163, 87100, Cosenza, Tel: 0984-33152, Fax: 0984-33152 / **Satep (Casoria NA)**, Via Nazionale Delle Puglie, 176, 80026, Casoria (NA), Tel: 081-7590706, Fax: 081-7590706 / **Audio Service Snc**, Via Cattaneo 4/6, 81100, Caserta, Tel: 0823-329099, Fax: 0823-353686 / **Drf Eletr.** Di Rubbo, Via M.Pacifico 118, 82100, Benevento, Tel: 0824-62416, Fax: 0824-62416 / **Elettronica D'Argenio**, Via Nazion. Torrette,195, 83013, Mercogliano (Av), Tel: 0825-681590, Fax: 0825-681590 / **Elettronica Service**, Viale Europa, 15, 80053, Castell. Stabia, Tel: 081-8728280, Fax: 081-8728280 / **Errediesse Service**, Via P. Mascagni 74/76, 80128, Napoli, Tel: 081-5794825, Fax: 081-5791899 / **M.C. Elettronica Snc**, Via Dei Mille 138, 84100, Salerno (Sa), Tel: 089-330591, Fax: 089-336836 / **Menna Elettronica Srl**, Via Nazionale Delle Puglie 294, 80026, Casoria (Na), Tel: 081-5840726, Fax: 081-7594277 / **Satec Di Correria Snc**, Via Libertá 307, 81024, Maddaloni (Ce), Tel: 0823-341088, Fax: 0823-343011 / **Video Eletr. 2 Di Nasti**, Via Ant.Pio 74/76, 80126, Napoli, Tel: 081-7676300, Fax: 081-7284347 / **Audio Video Center Snc**, Via F. Vandelli 23/29, 41100, Modena, Tel: 059-235219, Fax: 059-210265 / **Ass.Electron Di Fogliani**, Via F.Lli Aventi 19, 44100, Ferrara, Tel: 0532-903250, Fax: 0532-903250 / **Ma.Pi. Snc**, Via T.Azzolini 3, 40132, Bologna, Tel: 051-641115, Fax: 051-406848 / **Masini Service**, Via Mediterraneo 24, 47041, Bellaria (Fo), Tel: 0541-347714, Fax: 0541-324413 / **Nuova Tecnocoop**, Via Armellini 28/30/32, 47037, Bellaria Rimini, Tel: 0541-370812, Fax: 0541-370812 / **Parmaservice Sas**, Via Benedetta 47/A, 43100, Parma, Tel: 0521-271666, Fax: 0521-271666 / **Rimpelli Nelusco Snc**, Via Marchelli 7/C, 42100, Reggio Emilia, Tel: 0522-323740, Fax: 0522-376967 / **Rip.Eletr.Ravenna**, Via Reale, 27/C 48010, Camerlona (Ra), Tel: 0544-521500, Fax: 0544-521100 / **Rte Di I. Catellani & C.**, Via Premuda 38/V, 42100, Reggio Emilia (Re), Tel: 0522-381277, Fax: 0522-381788 / **Stema Snc**, V.Le Bologna, 92/A 47100, Forlì, Tel: 0543-704475, Fax: 0543-702742 / **Technolab Snc**, Via Romea 36, 48100, Ravenna,

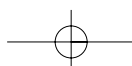



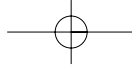

## SERVICE ADDRESSES

Via B. Tolomei 9, 53100, Siena, Tel: 0577-51159, Fax: 0577-589454 / **Saec Di Coppa**, Via Degli Artigiani 36, 54100, Massa, Tel: 0585-251724, Fax: 585791177 / **Tele Service Di Benvenuti**, Via F. Busoni 3/B, 50018, Scandicci, Tel: 055-753974, Fax: 055-7350267 / **Videoservice Di Genuardi**, Via Borgaccio 72, 53036, Poggibonsi (Si), Tel: 0577-983181, Fax: 0577-996382 / **Bardazzi Paolo**, Via Forlanini 8dr, 500127, Firenze, Tel: 055-4376776, Fax: 055-431956 / **Dal Pozzo Enzo**, Via Barletta 8, 39100, Bolzano, Tel: 0471-913290, Fax: 0471-913290 / **Melone Giuseppe**, Via Zara 44, 38100, Trento, Tel: 0461-235166, Fax: 0461-267210 / **Sighel Mauro**, Via A. Volta 92, 38100, Trento, Tel: 0461-935919, Fax: 0461-935919 / **Tecnoservice Snc**, Via San Vigilio 64/B-C-D, 39100, Bolzano, Tel: 0471-289062, Fax: 0471-261559 / **Quondam**, Via Del Rivo 33, 05100, Terni, Tel: 0744-301512, Fax: 0744-301512 / **Tecnoconsult Elettronica**, Via Madonna Alta 185, 06100, Perugia, Tel: 075-5003089, Fax: 075-5003089 / **C.A.T. Di D'isanto**, C. So Ivrea 82/A, 11100, Aosta, Tel: 0165-364056, Fax: 0165-235910 / **Ass.Eletr.Campi Snc**, Via E.Reginato 87, 31100, Treviso, Tel: 0422-436245, Fax: 0422-435996 / **D.D. Assistenza Tecnica**, Via Mondin 11, 32100, Belluno, Tel: 0437-30240, Fax: 0437-939916 / **DI Service Di Dal Lago**, Via Giaretta 33, 36100, Vicenza, Tel: 0444-566662, Fax: 0444-966239 / **G.F.L. S.R.L.**, Via D. De Massari 10, 37045, Legnago, Tel: 0442-602020, Fax: 0442-602021 / **Leletronica Piu' Snc**, Via Gaspare Campo 18, 45100, Rovigo, Tel: 0425-33221, Fax: 0425-33221 / **Pieffe Di Premier F.**, Via Zermanese 6/B, 31100, Treviso, Tel: 0422-321054, Fax: 0422-321054 / **Pierrezza Carlo**, Via Barroccio Dal Borgo 4, 35100, Padova, Tel: 049-8643266, Fax: 049-8643266 / **Sat Di Galber E C. Snc**, Via Catarinetti 1/E, 37136, Verona, Tel: 045-509609, Fax: 045-509699 / **Speedy Service**, Viale Europa 42/B, 36016, Thiene Vi, Tel: 0445-368235, Fax: 0445-379028 / **Tecno Futura Di Rossi**, Via Delfinato 8 (Laboratorio), 35127, Camin (Pd), Tel: 049-9129469, Fax: 049-9126147 / **Video Service**, Via Vitruvio 11, 37100, Verona, Tel: 045-566299, Fax: 045-573865 / **Video Tv 17323**, Via S. Marco 1818, 30019, Sittomarina (Ve), Tel: 041-5541675, Fax: 041-5541675 / **Vignardo Luigino**, Via Dell'industria 18, 30020, Gruaro (Ve), Tel: 0421-74472, Fax: 0421-72923 / **Zaffalon Urbano**, Cas.Calle Corraz. 3849, 30122, Venezia, Tel: 041-2750670, Fax: 041-2757273 / **Ecoservice Srl**, Via Buffolara 68/A, 43100, Parma, Tel: 0521/987402, Fax: 0521/987402 / **Novatecnica Snc**, Via Giovanale, 78/A - Viserba Di Rimini, 47037, Rimini / **Reat Srl**, Via Giardini Nord 8, 41043, Formigine (MO), Tel: 059-557168, Fax: 059-573517 / **Tecnoservice.Com**, Via Serenari, 28/C, 40100 Castelmaggiore (BO), Tel: 051-6321343, Fax: 051-6320781 / **Radiotecnica 96 Di Fattorini**, Via A. Cantore, 14, 33040 Povoletto (UD), Tel: 0432-666797, Fax: 02-700425181 / **Panservice**, Via S.Sotero, 36, 00165 Roma, Tel: 06-6380516, Fax: 06-6380973 / **Michelis Sandro**, Via Giannetti, 8/10, 18100 Imperia, Tel: 0183-275891, Fax: 0183-275891 / **Reat Di Frisina**, C. So Unione Sovietica, 584, 10135 Torino, Tel: 011-3979817, Fax: 011-3979817 / **Video Tecnica Di Rotulo**, Via Dante, 87/89, 92100 Agrigento, Tel: 0922-25183, Fax: 0922-20117 / **DBS Elettronica Di Aldovardi**, Via Simon Musico, 2/C, 54100 Massa, Tel: 0585-489893, Fax: 0585-886122

## ESPAÑA

**En caso de una reclamación con vuestra SHARP Microwave, preguntan por favor la casa dónde han comprado su máquina o infórmanse en una de las SHARP Service casas siguientes.**

**Lavison, C.B.**, 972/ 23.01.22, Cl Montseny 35, Girona, Girona / **Videocolor**, 93/ 454.99.08, Cl Villarroel 44, Barcelona, Barcelona  
**Argi Giltz**, 94/ 443.77.93, Cl Autonomia 15, Bilbao, Vizcaya / **Estarlich Pradas Vicente**, 93/ 766.22.33, Cl Industria 131, Calella, Barcelona / **Sabe Electronica**, 964/ 21.52.65, Cl Joaquin Costa 46, Castellon, Castellon / **Teknibat Electronica**, 943/ 70.24.37, Cl Zezenbide 4, Eibar, Guipuzcoa / **Electronica Gomez**, 96/ 546.75.81, Cl Baltasar Tristany 100, Elche, Alicante / **Ramon Villaret De Gea**, 93/ 798.02.48, Cl Moli De Vent 21, Mataro, Barcelona / **Irtesa Electronica**, 971/ 20.47.02, Cl Jaume Ferran 72 Bjos, Palma De Mallorca, Baleares (Mallorca) / **A. T. Pamplona**, 948/ 24.19.50, Cl Julian Gayarre 1, Pamplona, Navarra / **Ce.Va.Sat**, 93/ 710.76.13, Ps Rubio I Ors 105, Sabadell, Barcelona / **Servicios Electronicos**, 96/ 340.20.34, Cl Doctor Oloriz 3, Valencia, Valencia  
**Laurea S.A.T.**, 93/ 889.02.48, Cl Guillerias Bis 20, Vic, Barcelona / **Merino Nicolas Jose A.**, 945/ 25.18.92, Av Judizmendis 24, Vitoria-Gasteiz, Alava / **Ce. Va. Sat, S.C.**, 93/ 785.51.11, Cr Matadepera 87, Terrassa, Barcelona / **Unitec**, 948/ 82.74.34, Cl Fuente Canonigos 5, Tudela, Navarra / **Euro Tecnicos Electronica**, 977/ 32.24.89, Cl Lepanto 16-18, Reus, Tarragona / **Servitele**, 94/ 444.89.02, Cl Autonomia 24 Galerias, Bilbao, Vizcaya / **Satel**, 972/ 26.55.19, Ps De Barcelona 12, Olot, Girona  
**Ielsa, C.B.**, 973/ 24.71.27, Cl Tarragona 40, Lleida, Lleida / **Estudios 3, C.B.**, 943/ 45.37.97, Pz De Los Estudios 3, San Sebastian, Guipuzcoa / **Monje Ureña Manuel**, 972/ 70.25.52, Cl Sant Quinti 33, Ribes De Freser, Girona / **Cristel**, 973/ 27.08.26, Cl Valcaient 32, Lleida, Lleida / **Teleservic**, 974/ 31.34.44, Cl Estadilla 6, Barbastro, Huesca / **Insat, Cb**, 971/ 36.53.18, Cl Pintor Calbo 30, Mahon, Baleares (Menorca) / **Electronica S. Torres**, 977/ 21.21.48, Cl Ernest Vilches 4-B L-2, Tarragona, Tarragona / **Asiste, S.L.**, 964/ 21.57.69, Av De Valencia Nave 19, Castellon / **Sonovision, C.B.**, 978/ 60.11.74, Cl Abadia 5, Teruel, Teruel / **Buira Tecnic's**, 977/ 66.04.37, Cl San Javier 55, El Vendrell, Tarragona / **Tecnik's, S.C.P.**, 93/ 630.11.20, Cl Joan Bardina 32, Sant Boi De Ll., Barcelona / **Elde**, 93/ 872.85.42, Cl Bruch 55, Manresa, Barcelona / **Teleservic**, 974/ 22.01.39, Cl Tenerias 20, Huesca, Huesca / **Servinters, S.C.C.L.**, 93/ 389.44.60, Pz Casagemes 20, Badalona, Barcelona / **Elec.Safont Montraveta, Sc**, 93/ 821.30.03, Cl Gral. Manso Sola 31, Berga, Barcelona / **Tecno Hogar**, 96/ 286.53.35, Cl Dos De Mayo 41, Gandia, Valencia / **Reparaciones Ortega**, 971/ 39.01.55, Cl Via Punica 33, Ibiza, Baleares (Ibiza) / **Telesonic**, 974/ 36.32.97, Cl Teruel 6, Jaca, Huesca / **Antonio Monleon, S.L.**, 96/ 334.55.87, Av De La Plata 91, Valencia, Valencia / **Electronica Las Heras**, 96/ 238.11.14, Cl Jose Iranzo 6, Ontinyent, Valencia / **Telecom Electronica**, 96/ 539.50.21, Cl Hernan Cortes 8, Elda, Alicante / **Audio Imagen**, 971/ 31.46.59, Cl Jose Riquer Llobet 8, Ibiza, Baleares (Ibiza) / **4 En 1 Reparaciones**, 93/ 430.97.26, Cl Taquigrafo Marti 19, Barcelona, Barcelona / **Sac-2, S.C.P.**, 93/ 331.77.54, Cl Riera Blanca 113, Barcelona, Barcelona / **Martorell Altes Francisco**, 977/ 75.32.41, Cl Roseta Mauri 10, Reus, Tarragona / **Cinca Monterde Antonio**, 976/ 31.69.65, Cl Via Universitas 52, Zaragoza, Zaragoza / **Electronica Josep**, 977/ 88.04.41, Cira. Igualada 29 Bjos, Sta. Coloma Queralt, Tarragona / **Fermo**, 93/ 465.22.00, Av Morera 5, Badalona, Barcelona / **Negredo Martin Daniel**, 94/ 411.22.82, Cl Padre Pernet 8, Bilbao, Vizcaya / **Collantes Martin Onofre**, 94/ 483.21.22, Cl Ortuño De Alango 7, Portugalete, Vizcaya / **Riera Daviu**, 972/ 50.32.64, Cl Torras Y Bages 19, Figueres, Girona / **Envisa Electronic, S.L.**, 96/ 241.24.87, Cl General Espartero 9, Alzira, Valencia / **F.Carceller-F.Cervera, C.B.**, 964/ 45.44.65, Cl Carrero 29, Vinaros, Castellon / **Eurosat, S.L.**, 96/ 525.80.40, Cl Montero Rios 33, Alicante, Alicante / **Teelco**, 93/ 805.11.90, Av Balmes 90, Igualada, Barcelona / **Audiovision**, 93/ 385.78.08, Cl Mare Deu Montserrat 22, Sta.Coloma Gramanet, Barcelona / **Tele-Color**, 96/ 585.24.60, Cl Del Vent 9, Benidorm, Alicante / **Tecno Service Mora**, 977/ 40.08.83, Cl Pau Picasso 1, Mora D'ebre, Tarragona / **Electronica Moncho**, 96/ 287.23.29, Cl Pare Pascual Catala 5, Gandia, Valencia / **Electronica Mateos**, 93/ 849.28.77, Cr De Caldas (Bajos) 76, Granollers, Barcelona / **Electron. Pons Gomila Sa**, 971/ 37.22.76, Cr Nueva 162, Alayor, Baleares (Menorca) / **Antonio Robles Sanchez**, 93/ 872.55.41, Cl Sant Bartomeu 42, Manresa, Barcelona / **Top Electronica**, 93/ 890.35.91, Cl Misser Rufet 4 Bjos, Vilafraanca Penedes, Barcelona / **Totvisio Electronica S.L.**, 93/ 873.88.81, Pj Ferrer 14, Manresa, Barcelona / **Satuf**, 973/ 50.08.48, Av Raval Del Carme 12, Tarrega, Lerida / **Fix Servicio Tecnico**, 93/ 675.59.02, Cl Valles 88, Sant Cugat Valles, Barcelona / **Seleco S.L.**, 977/ 70.00.12, Cl Calderon De La Barca 11, Amposta, Tarragona / **Instalaciones Maes, S.L.**, 971/ 27.49.47, Cl Son Nadal 63, Palma De Mallorca, Baleares (Mallorca) / **Sertecs, S.C.**, 977/ 22.18.51, Cl Caputxins (Bajos) 22, Tarragona, Tarragona / **Sonitev Electronica, C.B.**, 93/ 815.74.44, Cl Aigua 143, Vilanova I Geltru, Barcelona / **Aragon Televideo, S.C.**, 976/ 32.97.12, Cl Batalla Clavijo 18, Zaragoza, Zaragoza / **Jose Marques Anglada, S.L.**, 971/ 38.54.54, Cl Lepanto 19, Ciudadela, Baleares (Menorca) / **Electronica Alcañiz S.L.**, 979/ 87.07.94, Cl Carmen 21, Alcañiz, Teruel / **Teleservicio Bajo Aragon**, 978/ 87.08.10, Cl Romualdo Soler 4, Alcañiz, Teruel / **Reparaciones**

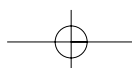

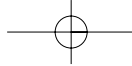

## SERVICE ADDRESSES

**Urruti S.L.**, 943/ 45.84.10, Ps Aintzieta 32, San Sebastian, Guipuzcoa / **Reparaciones Pilsa S.C.**, 972/ 20.66.96, Cl J. Pascual I Prats 8, Gerona, Gerona / **Electro Servei C.B.**, 977/ 51.04.42, Ps Moreira 10, Tortosa, Tarragona / **Electronica Santa Pola**, 96/ 571.25.58, Cl Orihuela 43, Torrevieja, Alicante / **Electronica Loguard**, 977/ 32.38.04, Cl Vapor Vell 17, Reus, Tarragona / **A.B.R. Electronica S.L.**, 977/ 50.21.20, Cl Calderon La Barca 3, Roquetas, Tarragona / **La Clinica Del Electrod.**, 93/ 236.44.11, Cl Balmes 160, Barcelona, Barcelona / **Angel Avellan Puig**, 965/ 21.32.55, Cl Poeta Quintana 13, Alicante, Alicante / **Pulgar I Edo S.L.**, 93/ 436.44.11, Cl Castillejos 333, Barcelona, Barcelona / **A.E. De Consumo**, 96/ 552.32.35, Cl Peru 42, Alcoy, Alicante / **Unisat**, 96/ 674.11.94, Cl Duque De Tamames 9, Orihuela, Alicante / **Electro-Sat**, 971/ 32.27.62, Cl Eivissa 12-16, S. Francesc De Formentera, Balears (Formentera) / **Garman C.B.**, 91/380.33.49, Cl Carlos Sole 38 Local, Madrid, Madrid / **Electronica Bote**, 924/ 22.17.40, Pz Portugal 2, Badajoz, Badajoz / **Ruiz Garcia Jose**, 927/ 22.48.86, Cl Ecuador 5-B, Caceres, Caceres / **Electronica Edimar**, S.A, 98/ 535.34.51, Cl Cangas De Onis 4, Gijon, Asturias / **Servicio Tecnico**, 956/ 87.07.05, Cl Divina Pastora E-1 L-4, Jerez La Frontera, Cadiz / **Electronica Torres**, S.C., 941/ 24.76.15, Av Navarra 14, Logroño, La Rioja / **Cañedo S.T.**, 98/ 522.29.68, Cl Otero, S/N C. Cial, Oviedo, Asturias / **Electronica Javier**, 979/ 75.03.74, Av Castilla 77, Palencia, Palencia / **Teleservicios**, 983/ 30.92.61, Cl Esgueva 6, Valladolid, Valladolid / **Central De Servicios**, 986/ 37.47.45, Cl Asturias (Bajo) 10, Vigo, Pontevedra / **Dueñas Cal As Teodoro**, 957/ 26.35.06, Cl Hermano Juan Fdez 15, Cordoba, Cordoba / **Telejara**, 959/ 22.60.74, Pol. Polirosa Cl-A Nave-27, Huelva, Huelva / **Alejandro Hernandez**, 978/ 60.85.51, Rb San Julian 59, Teruel, Teruel / **Caro Porlan Raimundo**, 968/ 46.18.11, Cl Jose Moulia 45, Lorca, Murcia / **Daniel Serrano Labrado**, 920/ 37.15.16, Cl Jose Gochicoa 16, Arenas De S.Pedro, Avila / **Electronica Fouces**, 982/ 40.24.38, Cl Benito Vicetto 34, Monforte De Lemos, Lugo / **Televideo**, 950/ 40.18.63, Cl Velazquez 7 Local-A, Adra, Almeria / **Reg., C.B.**, 968/ 51.00.06, Cl Ramon Y Cajal 27, Cartagena, Murcia / **Electronica Rivas**, 925/ 80.55.46, Cl Barrio San Juan 1, Talavera La Reina, Toledo / **Antonio Cazorla Luque**, 952/ 36.16.02, Cl Ciudad De Andujar 2, Malaga, Malaga / **Telson**, 987/ 21.25.18, Cl Batalla Clavijo 2, Leon, Leon / **Alvarez Oliver Casilda**, 98/ 522.37.39, Cl San Jose 12, Oviedo, Asturias / **Electronica Jumar**, 953/ 26.17.08, Cl Goya (Las Flores) 1, Jaen, Jaen / **Video Taller, S.C.**, 952/ 54.23.95, Edif. La Noria B Bjos-5, Torre Del Mar, Malaga / **Top Service**, 941/ 13.50.35, Cl Achutegui De Blas 17, Calahorra, La Rioja / **Electroservicios Seba,C.B.**, 968/ 29.85.93, Cl Isaac Albeniz 4 Bjos, Murcia, Murcia / **Garcia Quintela Arturo**, 981/ 70.21.07, Cl Xoane, Carballo, La Coruña / **Tv Video Jimenez, S.L.**, 967/ 34.04.43, Cl Juan Xxiii 38, Almansa, Albacete / **Electronica Mas**, 947/ 31.49.94, Cl Alfonso Vi 6, Miranda De Ebro, Burgos / **Manuel Mato Señaris**, 981/ 53.71.14, Cl Silvouta-Pedra Da, Santiago Compostela, La Coruña / **Electronica Gredos**, 920/ 22.48.39, Cl Eduardo Marquina 24, Avila, Avila / **Jimenez Almohalla Miguel**, 920/ 25.08.76, Cl Jacinto Benavente 1, Avila, Avila / **Jielsa**, 96/ 546.14.27, Cl Doctor Ferran 97, Elche, Alicante / **New Meresa**, 972/ 30.44.54, Cl Surera Bertran 23, Palafrugell, Girona / **Arsenio Sanchez**, C.B., 927/ 41.11.21, Cl Tornavacas 9, Plasencia, Caceres / **Electronica Barajas**, 91/ 305.48.90, Pz Del Jubilado 8, Barajas, Madrid / **Gallardo Alonso Miguel**, 958/ 67.64.81, Cl Carmen 104, Benalua De Guadix, Granada / **Aguado Gil Roberto**, 941/ 25.25.53, Av Viana 10, Logroño, La Rioja / **Zener Electronica**, 981/ 22.07.00, Cl Ronda De Monte Alto 15, La Coruña, La Coruña / **Electronica Garman, C.B.**, 91/ 368.01.79, Cl Mandarina 15, Madrid, Madrid / **Jose Borja Y Jose Arana**, 956/ 66.60.53, Cl San Antonio 31, Algeciras, Cadiz / **Servisuel, Edif. La Union**, 952/ 46.90.28, Cm De Las Cañadas Lc 2, Fuengirola, Malaga / **S.T. Mendez**, 981/ 27.52.52, Cl Gil Vicente 13, La Coruña, La Coruña / **Electronica Triana**, 95/ 433.83.03, Cl Evangelista 69-71 L-25, Sevilla, Sevilla / **Electronica Ansar**, 91/ 460.47.45, Cl Tomasa Ruiz 4, Madrid, Madrid / **Electronica Castilla**, 981/ 32.14.09, Cr Castilla 377-Bis Bjos, Ferrol, La Coruña / **Tec-Norte**, 91/851.63.47, Cl Santiago Apostol 5, Collado Villalba, Madrid / **Electronica Arellano**, 926/ 54.78.95, Cl Lorenzo Rivas 14, Alcazar De San Juan, Ciudad Real / **Fernandez Gonzalez Jose**, 988/ 23.48.53, Av Buenos Aires 75 Bjos, Orense, Orense / **Visatol**, 968/24.16.47, Cl Torre Alvarez S/N, Murcia, Murcia / **Electronica Fe-Car, S.L.**, 925/ 21.21.45, Av Santa Barbara 30, Toledo, Toledo / **Salvador Rodriguez, C.B.**, 987/ 40.36.02, Cl Ortega Y Gasset 24, Ponferrada, Leon / **Juan Gomez Orellana**, 956/ 46.25.01, Cl Fco.Fdez.Ordoñez 5 L-D, Ubrique, Cadiz / **Abril Sanchez Valentin**, 959/ 10.60.41, Cl Cadiz 2, Cala, Huelva / **Vilchez Vilchez Rafael**, 958/ 60.06.50, Cl Amadeo Vives 9, Motril, Granada / **Electro Servicios Plaza**, 968/ 28.45.67, Cl Gomez Cortina 10, Murcia, Murcia / **Telepal**, 95/ 464.95.80, Cl Julio Verne 49, Sevilla, Sevilla / **Auvitel, S.L.**, 95/ 427.57.07, Cl Virgen De Africa 20, Sevilla, Sevilla / **Electronica Wenceslao**, 958/ 81.16.16, Cl Fontiveros 42, Granada, Granada / **Zabala Vazquez Jose**, 927/ 57.06.13, Cl Del Agua 39, Losar De La Vera, Caceres / **Santiago Valderrey**, 98/ 563.18.61, Cl Dr. Venancio Mtez. 7, Navia, Asturias / **Variosat, S.L.**, 91/ 662.04.68, Cl Isla De Corcega 24, Alcobendas, Madrid / **Teco**, 975/ 22.61.25, Cl Antolin De Soria 10, Soria, Soria / **Imason**, 986/ 84.16.36, Cl Loureiro Crespo 43, Pontevedra, Pontevedra / **Telesonid Huelva, S.C.A.**, 959/ 24.38.60, Cl Fco.Vazquez Limon 4, Huelva, Huelva / **Guijo S.T.**, 921/ 42.94.18, Cl Teofilo Ayuso 2 Local, Segovia, Segovia / **Almat Electronica**, 923/ 22.45.08, Cl Galileo 21, Salamanca, Salamanca / **Electronica Seyma**, 942/ 23.69.19, Cl Del Monte 69 C Bjos, Santander, Cantabria / **Asist. Tecnica Marcos**, 983/ 29.78.66, Cl Pio Del Rio Hortega 2-4, Valladolid, Valladolid / **Tecnicas Marvi S.L.**, 949/ 23.27.63, Pz Capitan Boixareu 51, Guadalajara, Guadalajara / **Bandin Audio**, 981/ 86.60.23, Cl Rua Arcos Moldes 2 B-3, Rianxo, La Coruña / **Televexo S.L.**, 982/58.18.57, Cl Nosa Sra. Do Carmen 82, Burela, Lugo / **Digimat Electronica**, 958/ 70.04.52, Av Jose De Mora 16, Baza, Granada / **Serpriego S.L.**, 957/ 54.15.11, Cl San Luis 4 Bjo. Izda., Priego De Cordoba, Cordoba / **Instalacion Martin**, 669/ 85.98.80, Cl Alicante 11 (1ª - C), Getafe, Madrid / **Servirap**, 950/ 27.40.67, Cl Angel Ochotonera 11, Almeria, Almeria / **Tecnihogar**, 956/ 28.10.82, Cl Tolosa Latour 19, Cadiz, Cadiz / **Cayro**, 957/ 26.35.06, Cl Hermano Juan Fdez. 15, Cordoba, Cordoba / **Microm Electronica**, 957/ 23.02.22, Av Aeropuerto 2, Cordoba, Cordoba / **Fermasa**, 958/ 25.64.77, Cl Azorin 7, Granada, Granada / **Servigon**, 958/ 20.52.81, Cl Hospital De La Virgen 22, Granada, Granada / **Relegra S.L.**, 958/ 27.24.50, Cl Dr.Gomez Roman 5, Granada, Granada / **Servicoata**, 958/ 63.11.43, Pz Dr. Alvarez Riosol 1, Almuñecar, Granada / **Airsext Huelva**, 959/ 22.88.13, Ps De La Glorieta 6, Huelva, Huelva / **Electro Sur**, 959/ 29.06.15, Cl Alonso De Ercilla 23, Huelva, Huelva / **Climaire Plus**, 95/ 234.50.36, Cl Guaro 4, Malaga, Malaga / **Covitel**, 95/ 231.62.50, Cl Ceramistas 8, Malaga, Malaga / **Luis Rivas Caldas**, 95/ 451.73.55, Cl Febo 16, Sevilla, Sevilla / **Intersat Sevilla**, 95/ 443.02.26, Cl Beethoven 5, Sevilla, Sevilla / **Frilar**, 95/ 492.14.44, Pol. Indust. Navisa C/A 47, Sevilla, Sevilla / **Pedro L. Villagrana**, 976/ 37.10.20, Cl Augusto Borderas 3-5 Lzq., Zaragoza, Zaragoza / **G.A.M.I.F.E.L.**, 98/ 528.43.60, Cl Ricardo Montes 6, Oviedo, Asturias / **Amsa**, 971/ 27.27.57, Cl Isidoro Antillon 97, Palma De Mallorca, Balears / **Teclurami Menorca**, 971/ 35.28.02, Cl Pintor Calbo 57, Mahon, Balears / **David Trogregosa Jorda**, 965/ 33.43.06, Cl Terrasa 6, Alcoy, Alicante / **Electronica Bersabe**, 95/ 483.33.93, Pasaje Merinos 62 A, Ecija, Sevilla / **Novomam-Sat**, 956/ 40.12.09, Pol. Urbisur, Jorge Juan 4, Chiclana De La Frontera, Cadiz / **Video Service Electronic**, 91/ 880.27.87, Cl Era Honda 9, Alcalá De Henares, Madrid / **Servei Tecníc Ferrer**, 93/ 710.51.38, Cl Sarda 37, Sabadell, Barcelona / **Fred Vilafranca**, 93/ 890.48.52, Cl Progres 42, Vilafranca Del Penedes, Barcelona / **Domca**, 973/ 24.74.46, Cl Tarragona 29, Lerida, Lerida / **Mañe Grifolls**, 977/ 69.04.39, Cl Jesus 21, Calafell, Tarragona / **Ramsat**, 981/ 74.74.61, Av Finisterre 117-B, Cee, La Coruña / **Victor Perez Quintela**, 981/ 58.43.92, Cl Entrerios 35, Santiago De Compostela, La Coruña / **Antonio Rodriguez Alvarez**, 988/ 22.40.98, Cl Cabeza De Manzaneda 7, Orense, Orense / **Ugenasa**, 91/ 611.52.51, Cl La Canaleja 4, Alcorcon, Madrid / **Javier Acevedo**, 91/ 843.01.58, Pz Mayor 5, Torrelaguna, Madrid

**Tecniblan**, 968/ 29.39.99, Cl Jose Javier 1, Murcia, Murcia / **Angel Lopez Alcaraz**, 968/ 29.39.10, Cl Sierra Del Espartal 6 (Edif. Ana), Murcia, Murcia / **Elbeservi, S.A.**, 91/ 386.27.11, Cl Dr.R. Castroviejo 19, Madrid, Madrid / **Televideo Nervion**, 95/ 458.10.66, Cl Juan Curiel 22, Sevilla, Sevilla / **Servicio Tecnico Ponce**, 950/ 13.28.37, Plg Ps Maritimo E-Europa 1, Garrucha, Almeria / **Marcial Lagoa Gonzalez**, 924/ 49.03.33, Cl Ramon Y Cajal 7, Olivenza, Badajoz / **Electronica Gonzalez**, 953/ 50.33.82, Corredera San Bartolome 11,

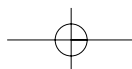

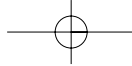

## SERVICE ADDRESSES

Andujar, Jaen / **Sat Tv Video Vazquez**, 926/ 42.09.93, Cl Aduana 3, Puertollano, Ciudad Real / **C.E. Vilanovense C.B.**, 924/ 84.59.92, Cl Camino Magacela 4 Local-5, Villanueva Serena, Badajoz / **Electronica Sales**, 957/ 66.09.04, Cl Andalucia 11, Aguilar Frontera, Cordoba / **Astusetel S.L.**, 98/ 539.10.11, Cl Cea Bermudez 9, Gijon, Asturias / **niservic Electronica**, 953/ 75.14.19, Cl Goya 1 Bjos, Ubeda, Jaen / **Radio Sanchez C.B.**, 927/ 32.06.88, Av De Miajadas S/N, Trujillo, Caceres / **Asturservice**, 98/ 556.83.87, Cl Sanchez Calvo 6 Bjos., Aviles, Asturias / **Electrodiaz S.L.**, 926/ 32.23.24, Cl Buensuceso 10, Valdepeñas, Ciudad Real / **Tele-Nueva**, 926/ 50.59.96, Cl Campo 56, Tomelloso, Ciudad Real / **Juan Morillon Del Corro**, 98/ 567.40.24, Av De Gijon 19, La Felguera/Langreo, Asturias / **Electronica Centeno S.L.**, 924/ 57.53.08, Av Del Zafrá 1, Puebla Sancho Perez, Badajoz / **Electronica Penelo**, 982/ 21.47.43, Cl Serra Gañidoira 63, Lugo, Lugo / **Galan Sat S.L.**, 956/ 20.14.17, Cl Cruz Roja Española 11, Cadiz, Cadiz / **Galan Sat S.L.**, 956/ 83.35.35, Cl Factoria Matagorda 52, Puerto Real, Cadiz / **Servitec Burgos S.L.**, 947/ 22.41.68, Cl Lavaderos 7-9, Burgos, Burgos / **Electronica Garcia**, 969/ 22.24.83, Cl Ramon Y Cajal 17, Cuenca, Cuenca / **Indalecio Amaya Sanchez**, 924/ 66.47.01, Cl Carreras 11, Almendralejo, Badajoz / **Lavison Electronica S.L.**, 957/ 75.01.75, Cm De La Barca 3, Cordoba, Cordoba / **Antonio Gonzalez Esquinas**, 957/ 57.10.50, Cl Gral Primo Rivera 61, Peñarroya, Cordoba / **Electronica Jopal S.L.**, 925/ 25.04.42, Av Santa Barbara S/N, Toledo, Toledo / **Juman**, 967/ 22.40.78, Cl Ejercito 1, Albacete, Albacete / **Anuma**, 953/ 69.70.41, Cl Paredon 24, Linares, Jaen / **Electro 93 S.L.**, 95/ 472.37.16, Cl Melliza 1, Dos Hermanas, Sevilla / **Sonivitel S.L.**, 950/ 22.97.55, Cl Poeta Paco Aquino 51, Almeria, Almeria / **Sial-Alvimo S.L.**, 986/ 29.93.01, C/ C.Torrecedeira 92 Bjos, Vigo, Pontevedra / **Patricio Electronica**, 924/ 33.04.13, Cl Reyes Huertas 7, Merida, Badajoz / **Electronica Cambados**, 986/ 50.83.27, Cl Camilo Jose Cela 13, Vilagarcia Arousa, Pontevedra / **Electronica Vitelson**, 983/ 80.43.56, Pz Del Mercado 9, Medina Del Campo, Valladolid / **Megatecnica Extremera**, 958/ 26.06.01, C/.Mozart L2 Ed.Granate, Granada, Granada / **R.T.V. Blanco**, 980/ 51.14.41, Cl Eduardo Julian Perez 9, Zamora, Zamora / **Rafael Gomez Yelo**, 968/ 26.14.67, Ps Corbera 17, Murcia, Murcia / **Prosat**, 987/ 20.34.10, Pz Doce Martires 5, Leon, Leon / **Electro Anaya**, 925/ 48.09.81, Cl Vertedera Alta 14, Consuegra, Toledo / **S.A.T. Juan-Manuel**, 98/ 581.22.48, Cl Uria 60, Cangas De Narcea, Asturias / **Manuel Alea Villa**, 98/ 592.26.40, Cl Llano Morgolles S/N, Cangas De Onis, Asturias / **Electro Himega, S.A.**, 953/ 24.22.56, Cl Adarves Bajos 4-C, Jaen, Jaen / **Electrogan**, 956/ 87.07.05, Cl Pagador 31, Pto. Sta. Maria, Cadiz / **Servitel**, 956/ 33.76.55, Cl Porvenir 11 Local, Jerez La Frontera, Cadiz / **Lara Technitel**, 926/ 21.17.87, Cl De La Jara 1, Ciudad Real, Ciudad Real / **Parreño**, 967/ 22.62.49, Cl Santiago Rusiñol 50, Albacete, Albacete / **Victor Quiles Parra**, 926/ 32.54.38, Cl Jose Ramon Osorio 57, Valdepeñas, Ciudad Real / **S.T.C.**, 696/ 20.14.08, Cl Nord 24, Palafrugell, Girona / **Ferreteria Toledano**, 949/ 23.02.61, Cl Ejercito 17 A, Guadalajara, Guadalajara / **Satelec**, 926/ 22.01.55, Cl Libertad 13 L-1, Ciudad Real, Ciudad Real / **Reparaciones San Segundo**, 920/ 22.33.21, Cl Soria 6, Avila, Avila / **Tecnyser Electro**, 987/ 22.77.87, Cl Relojero Losada 25, Leon, Leon / **Multiservicio Palencia**, 979/ 74.53.80, Cl Cardenal Cisneros 20, Palencia, Palencia / **J. Daniel Martinez**, 923/ 19.16.10, Cl Abraham Lacut 11-15, Salamanca, Salamanca / **Jesus Alburquerque**, 983/ 24.62.26, Cl Vinos Ribera Del Duero 10, Valladolid, Valladolid / **Domotica**, 93/ 408.66.22, Av Diagonal 296, Barcelona, Barcelona / **Salja & Mat**, 93/ 668.13.61, Cl La Raseta 15 L-3, Molins De Rey, Barcelona / **Alameda Barcelo 46**, 952/ 32.00.77, Av Velazquez 5, Malaga, Malaga / **Fermafrio**, 956/ 28.10.82, Pz España 1, Cadiz, Cadiz / **Elotronic**, 968/ 46.16.22, Pz Don Juan Moreno 8, Lorca, Murcia / **Electro Reparaciones 2000**, 948/ 26.79.12, Cl Monasterio Fitero 26, Pamplona, Pamplona / **Telnor**, 94/ 417.04.97, Pz Juanene 5 Tras., Erandio, Bilbao / **Instalacant**, 96/ 525.93.55, Cl Daya Vieja S/N Local 7, Alicante, Alicante / **Airnet**, 96/ 533.17.53, Cl Oliver 35, Alcoy, Alicante / **Arcadio Martinez**, 96/ 585.49.17, Cl Almudena 6, Benidorm, Alicante / **Joaquin A. Lon Jaen**, 96/ 578.67.50, Cl Patricio Ferrandiz 66, Denia, Alicante / **Trinitario Gea**, 96/ 545.56.25, Cl Jaime Pomares Javaloyes 47, Elche, Alicante / **Jose A. Patiño Villena**, 96/ 571.74.29, Cr De Bigastro 1, Orihuela, Alicante / **Electroservicios Plaza**, 96/ 828.45.67, Pz Santiago 5, Orihuela, Alicante / **E.Electrosax**, 96/ 547.42.32, Cl Rio Turia 1, Sax, Alicante / **Vensat Reparaciones**, 964/ 20.57.12, Cl Pintor Lopez 43, Castellon, Castellon / **Electronica Bg**, 952/ 78.50.09, Cl Andalucia 2, San Pedro De Alcantara, Malaga / **Servimart**, 964/ 51.32.05, Av Corts Valencianes 8, Burriana, Castellon / **Tefrival**, 96/ 333.19.00, Av Ausias March 6, Valencia, Valencia / **Mº Jesus Fernandez Pinilla**, 96/ 329.67.29, Cl Castellon De Rugat 8-S, Valencia, Valencia / **Angel Rodero Bellow**, 926/ 51.52.76, Cl Asturias 26, Tomelloso, Ciudad Real / **Climatex**, 652/ 79.03.60, Cl Pozo 3 4º A, Puertollano, Ciudad Real / **Antonio Jover Torregrosa**, 607/ 61.77.99, Cl Espronceda 12 Entlo. Izqda., Alicante, Alicante / **Feliu Canalias**, 972/ 73.01.72, Cl Major 26, Campdevanòl, Girona / **A.T. Tv. Video**, 965/ 80.02.31, Av De La Constitucion 185 D, Villena, Alicante / **Servicio Tecnico Paster**, 696/17.86.458, Av Arcadio Pardiñas 77, Burela, Lugo

## SWITZERLAND

**Sharp Electronics AG**, Langwiesenstrasse 7, 8108 Dällikon, Tel: +41 1 846 61 11.

## SWEDEN

**Vid förfrågningar angående din mikrovågsugn var vänlig kontakta din återförsäljare eller någon av Sharps representanter Centralservice Umeå**, Formvägen 8, 90621 Umeå, Phone: 090-125001, Fax: 090-131135 / **MN Elektronikservice AB**, Flygplatsinfarten 10A, 161 11 Bromma, Phone: 08-6275900, Fax: 08-6275160 / **Jönköpings Antenn & TV Service**, Fridhemsvägen 20, 553 02 Jönköping, Phone: 036-161690, Fax: 036-160211 / **Ratronik Radio & TV Service**, Nordlandergatan 15, 931 32 Skellefteå, Phone: 0910-17305, Fax: 0910-16844 / **Tomi Elektronik AB**, Bäckvägen 90, 126 47 Hägersten, Phone: 08-186170, Fax: 08-186175 / **Tretronik**, Östermovägen 33, 854 62 Sundsvall, Phone: 060-155925, Fax: 060-173690 / **TV-Trim Service AB**, S:T Pauligatan 37, 416 60 Göteborg, Phone: 031-847200, Fax: 031-847500

## NORWAY

**Finn Clausen AS**, Postbox 274, No-0511 Oslo, Phone: 47-22635000, Fax: 47-22646655  
**Norsk Elektronik senter**, Postbox 13, No-2007 Kjeller, Phone: +47-63804500, Fax: +47-63804501

## ICELAND

**Braedurnir Ormsson Ltd**, PO box 8790, IS-128 Reykjavik, Phone: +354-5332800, Fax: +354-5332810  
**Hjólmtækni Ehf**, Skeifar, IS-108 Reykjavik, Phone: +354-5332150, Fax: +354-5332151

## DENMARK

**Sö Höyem AS**, Büllowsvej 3, DK-1870 Fredriksberg C, Phone: 45-31224434, Fax: 45-31224127  
**Almstock Radio & Tv service**, Sallingsvej 61, DK-2720 Vanløse, Phone: 45-38740021, Fax: 45-38740031

## SUOMI

**Oy Perkkio**, PL 40 Rällsintie 6, SF-00721 Helsinki, Phone: +35-8947805000, Fax: +35-8947805480  
**Theho Video Oy**, Niityläntie 3, SF-0620 Helsinki, SUOMI Phone: +35-891461500, Fax: +35-891461767

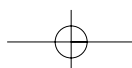



## SPECIFICATIONS

AC Line Voltage		: 230 V, 50 Hz, single phase
Distribution line fuse/circuit breaker		: Minimum 16 A
AC Power required:	Microwave	: 1,3 kW
	Grill	: 1,15 kW
	Dual	: 2,4 kW
Output power:	Microwave	: 800 W (IEC 60705)
	Top Grill	: 0,7 kW
	Bottom Grill	: 0,4 kW
Microwave Frequency		: 2450 MHz
Outside Dimensions		: 450 mm (W) x 298 mm (H) x 380 mm (D)
Cavity Dimensions		: 296 mm (W) x 203 mm (H) x 297 mm (D)
Oven Capacity		: 18 litres
Turntable		: ø275 mm, metal
Weight		: approx. 15 kg
Oven lamp		: 25 W/240 - 250 V

This oven complies with the requirements of Directives 89/336/EEC and 73/23/EEC as amended by 93/68/EEC.

SPECIFICATIONS ARE SUBJECT TO CHANGE WITHOUT NOTICE AS PART OF CONTINUOUS IMPROVEMENT

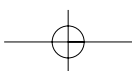
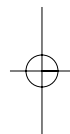
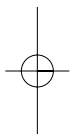
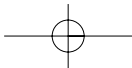

# SHARP

SHARP ELECTRONICS (EUROPE) GMBH.

Sonninstrasse 3  
20097 Hamburg  
Germany

## SHARP MANUFACTURING

ist ein Mitglied von:

est un membre de:

is een lid van:

è un membro di:

es un miembro de:

é um membro de:

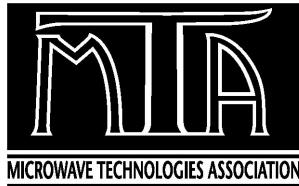

<http://www.microwaveassociation.org.uk/>

Gedruckt in Grossbritannien

Imprimé au Royaume-Uni

Gedruckt in Groot-Brittannie

Stampato in Gran Bretagna

Impreso en el Reino Unido

Impresso no Reino Unido



Das Papier dieser  
Bedienungsanleitung  
besteht zu 100 %  
aus Altpapier

Le papier de ce  
mode d'emploi est  
fait de 100 %  
de papier réutilisé

De papier voor deze  
gebruiksaanwijzing  
is van 100 %  
hergebruiken papier  
gemaakt

La carta di questo  
manuale d'istruzioni  
è fatta di 100 %  
della carta riciclata

El papel de este  
manual de  
instrucciones se  
hace de 100 %  
es del papel  
reciclado

O papel deste  
manual da operação  
é feito de 100 %  
do papel recycled

TINS-A32OURRO



# SHARP

SHARP ELECTRONICS (EUROPE) GMBH.

Sonninstrasse 3  
20097 Hamburg  
Germany

## SHARP MANUFACTURING

ist ein Mitglied von:

est un membre de:

is een lid van:

è un membro di:

es un miembro de:

é um membro de:

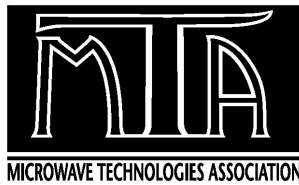

<http://www.microwaveassociation.org.uk/>

Gedruckt in Grossbritannien

Imprimé au Royaume-Uni

Gedruckt in Groot-Brittannie

Stampato in Gran Bretagna

Impreso en el Reino Unido

Impresso no Reino Unido



Der Zellstoff zur  
Herstellung dieses  
Papiers kommt zu  
100 % aus nachhaltig  
bewirtschafteten  
Wäldern

Ce papier est  
entièrement fabriqué  
à partir de pâte à  
papier provenant  
de forêts durables

De pulp die gebruik is  
voor de vervaardiging  
van dit papier is voor  
100 % afkomstig uit  
bossen die doorlopend  
opnieuw aangeplant  
worden

Il 100 % della pasta  
utilizzata per  
produrre questa carta  
proviene da foreste  
sostenibili

El 100 % de la  
pasta utilizada en  
la fabricación de  
este papel procede  
de bosques  
sostenibles

Este papel é  
totalmente fabricado  
a partir de pasta de  
papel proveniente  
de florestas duráveis

TINS-A32OURRO