

# SHARP®

## MICROWAVE OVEN OPERATION MANUAL

### MODELS

## R-520K / R-520L

Followed by letter indicating color

K=black, W=white, S=stainless steel



### CONTENTS

• For Customer Assistance	
..... Inside Front Cover	
• Precautions to Avoid Possible Exposure to Excessive Microwave Energy	Inside Front Cover
• Consumer Limited Warranty	1
• Product Information Card	1
• Important Safety Instructions	2
• Unpacking and Installation Instructions	3
• Grounding Instructions	3
• Information You Need to Know	4-6
• Part Names	7-8
• Before Operating	9
• Manual Operation	9
• Special Features	10-15
• Other Convenient Features	16-17
• Cleaning and Care	18
• Service Call Check	19
• Cookbook Information	19
• Cookbook Order Form	20
• Specifications	20
• Guia Auto-Touch	Parte Interior de la Cubierta Trasera
• Auto-Touch Guide	Back Cover

Read all instructions carefully before using the oven.

# FOR CUSTOMER ASSISTANCE

To aid in reporting this microwave oven in case of loss or theft, please record below the model number and serial number located on the unit. We also suggest you record all the information listed and retain for future reference.

MODEL NUMBER _____	SERIAL NUMBER _____
DATE OF PURCHASE _____	
DEALER _____	TELEPHONE _____
SERVICER _____	TELEPHONE _____

## TO PHONE:

DIAL 1-800-BE-SHARP (237-4277) for:

SERVICE (for your nearest Sharp Authorized Servicer)

PARTS (for your authorized parts distributor)

ADDITIONAL CUSTOMER INFORMATION

ACCESSORIES and COOKBOOK

## TO WRITE:

Sharp Electronics Corporation

Customer Assistance Center

1300 Naperville Drive

Romeoville, IL 60446-1091

Please provide the following information when you write or call: model number, serial number, date of purchase, your complete mailing address (including zip code), your daytime telephone number (including area code) and description of the problem.

**TO ACCESS INTERNET:** [www.sharppusa.com](http://www.sharppusa.com)

## PRECAUTIONS TO AVOID POSSIBLE EXPOSURE TO EXCESSIVE MICROWAVE ENERGY

- (a) Do not attempt to operate this oven with the door open since open-door operation can result in harmful exposure to microwave energy. It is important not to defeat or tamper with the safety interlocks.
- (b) Do not place any object between the oven front face and the door or allow soil or cleaner residue to accumulate on sealing surfaces.
- (c) Do not operate the oven if it is damaged. It is particularly important that the oven door close properly and that there is no damage to the: (1) door (bent), (2) hinges and latches (broken or loosened), (3) door seals and sealing surfaces.
- (d) The oven should not be adjusted or repaired by anyone except properly qualified service personnel.

# CONSUMER LIMITED WARRANTY

SHARP ELECTRONICS CORPORATION warrants to the first consumer purchaser that this Sharp brand product (the "Product"), when shipped in its original container, will be free from defective workmanship and materials, and agrees that it will, at its option, either repair the defect or replace the defective Product or part thereof with a new or remanufactured equivalent at no charge to the purchaser for parts or labor for the period(s) set forth below.

This warranty does not apply to any appearance items of the Product nor to the additional excluded item(s) set forth below nor to any Product the exterior of which has been damaged or defaced, which has been subjected to improper voltage or other misuse, abnormal service or handling, or which has been altered or modified in design or construction.

In order to enforce the rights under this limited warranty, the purchaser should follow the steps set forth below and provide proof of purchase to the servicer.

The limited warranty described herein is in addition to whatever implied warranties may be granted to purchasers by law. ALL IMPLIED WARRANTIES INCLUDING THE WARRANTIES OF MERCHANTABILITY AND FITNESS FOR USE ARE LIMITED TO THE PERIOD(S) FROM THE DATE OF PURCHASE SET FORTH BELOW. Some states do not allow limitations on how long an implied warranty lasts, so the above limitation may not apply to you.

Neither the sales personnel of the seller nor any other person is authorized to make any warranties other than those described herein, or to extend the duration of any warranties beyond the time period described herein on behalf of Sharp.

The warranties described herein shall be the sole and exclusive warranties granted by Sharp and shall be the sole and exclusive remedy available to the purchaser. Correction of defects, in the manner and for the period of time described herein, shall constitute complete fulfillment of all liabilities and responsibilities of Sharp to the purchaser with respect to the Product, and shall constitute full satisfaction of all claims, whether based on contract, negligence, strict liability or otherwise. In no event shall Sharp be liable, or in any way responsible, for any damages or defects in the Product which were caused by repairs or attempted repairs performed by anyone other than an authorized servicer. Nor shall Sharp be liable or in any way responsible for any incidental or consequential economic or property damage. Some states do not allow the exclusion of incidental or consequential damages, so the above exclusion may not apply to you.

THIS WARRANTY GIVES YOU SPECIFIC LEGAL RIGHTS. YOU MAY ALSO HAVE OTHER RIGHTS WHICH VARY FROM STATE TO STATE.

**Your Product Model Number & Description:**

R-520K and R-520L Home Use Carousel Microwave Oven. (Be sure to have this information available when you need service for your Product.)

**Warranty Period for this Product:**

One (1) year parts and labor. The warranty period continues for an additional four (4) years, for a total of five (5) years, with respect to the magnetron tube in the Product for parts only; labor and service are not provided free of charge for this additional period.

**Additional Item(s) Excluded from Warranty Coverage (if any):**

Non-functional accessories, turntable and light bulb.

**Where to Obtain Service:**

From a Sharp Authorized Servicer located In the United States. To find the location of the nearest Sharp Authorized Servicer, call Sharp toll free at 1-800-BE-SHARP (1-800-237-4277).

**What to do to Obtain Service:**

Ship prepaid or carry in your Product to a Sharp Authorized Servicer. Be sure to have **Proof of Purchase** available. If you ship the Product, be sure it is insured and packaged securely.

TO OBTAIN SUPPLY, ACCESSORY OR PRODUCT INFORMATION, CALL 1-800-BE-SHARP OR VISIT [www.sharppusa.com](http://www.sharppusa.com). SAVE THE PROOF OF PURCHASE AS IT IS NEEDED SHOULD YOUR OVEN EVER REQUIRE WARRANTY SERVICE.

## PRODUCT INFORMATION CARD

The Product information card should be completed within ten days of purchase and returned. We will keep it on file and help you access the information in case of loss, damage or theft. This will also enable us to contact you in the unlikely event that any adjustments or modifications are ever required for your oven.

# IMPORTANT SAFETY INSTRUCTIONS

When using electrical appliances basic safety precautions should be followed, including the following:

**WARNING** - To reduce the risk of burns, electric shock, fire, injury to persons or exposure to excessive microwave energy:

1. **READ ALL INSTRUCTIONS BEFORE USING THE APPLIANCE.**
2. Read and follow the specific “**PRECAUTIONS TO AVOID POSSIBLE EXPOSURE TO EXCESSIVE MICROWAVE ENERGY**” on inside front cover.
3. This appliance must be grounded. Connect only to properly grounded outlet. See “**GROUNDING INSTRUCTIONS**” on page 3.
4. Install or locate this appliance only in accordance with the provided installation instructions.
5. Some products such as whole eggs and sealed containers—for example, closed glass jars—are able to explode and should not be heated in this oven.
6. Use this appliance only for its intended use as described in this manual. Do not use corrosive chemicals or vapors in this appliance. This type of oven is specifically designed to heat, cook or dry food. It is not designed for industrial or laboratory use.
7. As with any appliance, close supervision is necessary when used by children.
8. Do not operate this appliance if it has a damaged cord or plug, if it is not working properly or if it has been damaged or dropped.
9. This appliance should be serviced only by qualified service personnel. Contact nearest Sharp Authorized Servicer for examination, repair or adjustment.
10. Do not cover or block any openings on the appliance.
11. Do not store or use this appliance outdoors. Do not use this product near water—for example, near a kitchen sink, in a wet basement, near a swimming pool, or similar locations.
12. Do not immerse cord or plug in water.
13. Keep cord away from heated surfaces.
14. Do not let cord hang over edge of table or counter.
15. See door surface cleaning instructions on page 18.
16. To reduce the risk of fire in the oven cavity:
  - a. Do not overcook food. Carefully attend to appliance when paper, plastic or other combustible materials are placed inside the oven to facilitate cooking.
17. Liquids, such as water, coffee or tea are able to be overheated beyond the boiling point without appearing to be boiling. Visible bubbling or boiling when the container is removed from the microwave oven is not always present. **THIS COULD RESULT IN VERY HOT LIQUIDS SUDDENLY BOILING OVER WHEN A SPOON OR OTHER UTENSIL IS INSERTED INTO THE LIQUID.**

To reduce the risk of injury to persons:

  - b. Remove wire twist-ties from paper or plastic bags before placing bag in oven.
  - c. **If materials inside the oven ignite, keep oven door closed, turn oven off and disconnect the power cord or shut off power at the fuse or circuit breaker panel.**
  - d. Do not use the cavity for storage purposes. Do not leave paper products, cooking utensils or food in the cavity when not in use.
18. If the oven is installed as a built-in, observe the following instructions:
  - a. Do not operate any heating or cooking appliance beneath this appliance.
  - b. Do not mount unit over or near any portion of a heating or cooking appliance.
  - c. Do not mount over a sink.
  - d. Do not store anything directly on top of the appliance surface when the appliance is in operation.
19. If the oven light fails, consult a SHARP AUTHORIZED SERVICER.

## SAVE THESE INSTRUCTIONS

# UNPACKING AND INSTALLATION INSTRUCTIONS

## Unpacking and Examining Your Oven

1. Remove all packing materials from inside the oven cavity. **DO NOT REMOVE THE WAVEGUIDE COVER**, which is located on the right cavity wall.

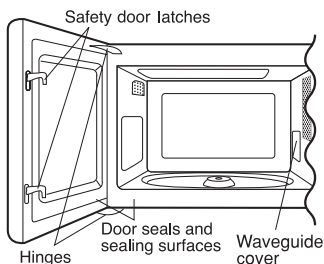

Read enclosures and **SAVE** the Operation Manual.

2. Remove the feature sticker, if there is one, from the outside of the door.

Check the oven for any damage, such as misaligned or bent door, damaged door seals and sealing surfaces, broken or loose door hinges and latches and dents inside the cavity or on the door. If there is any damage, do not operate the oven and contact your dealer or SHARP AUTHORIZED SERVICER.

## Choosing a Location for Your Oven

You will use the oven frequently so plan its location for ease of use. It's wise, if possible, to have counter space on at least one side of the oven. Allow at least 2 inches on

the sides, top and at the rear of the oven for air circulation. Do not place or install the oven in any area where heat and steam are generated; for example, next to or above a conventional gas or electric range or above a conventional wall oven. Heat and steam may damage the electronics or the mechanical parts of the oven.

## Built-in Kit

Some microwave models can be built into a cabinet or wall—not near or above a heat source—using Sharp's Built-In Kit black RK-51K (27") or RK-51K30 (30") for the R-520LK, the white RK-51W (27") or RK-51W30 (30") for the R-520LW. There is no built-in kit for the R-520KS. If your dealer does not stock the kit, it can be ordered directly from the Sharp Accessories and Supplies Center. Have your credit card number available and call toll-free: **1-800-237-4277** for ordering the kit to be sent to your address.

The kit includes ducts, finish trim strips and easy-to-follow instructions for installation as well as the location of the power supply.

# GROUNDING INSTRUCTIONS

This appliance must be grounded. This oven is equipped with a cord having a grounding wire with a grounding plug. It must be plugged into a wall receptacle that is properly installed and grounded in accordance with the National Electrical Code and local codes and ordinances. In the event of an electrical short circuit, grounding reduces risk of electric shock by providing an escape wire for the electric current.

**WARNING** – Improper use of the grounding plug can result in a risk of electric shock.

## Electrical Requirements

The electrical requirements are a 120 volt 60 Hz, AC only, 15 amp. or more protected electrical supply. It is recommended that a separate circuit serving only this appliance be provided.

The oven is equipped with a 3-prong grounding plug. It must be plugged into a wall receptacle that is properly installed and grounded. Should you only have a 2-prong outlet, have a qualified electrician install a correct wall receptacle.

A 3-prong adapter may be purchased and used temporarily if local codes allow. Follow package directions.

A short power-supply cord is provided to reduce risk of becoming entangled in or tripping over a longer cord.

## Extension Cord

If it is necessary to use an extension cord, use only a 3-wire extension cord that has a 3-blade grounding plug and a 3-slot receptacle that will accept the plug on the microwave oven. The marked rating of the extension cord should be AC 115-120 volt, 15 amp. or more.

Be careful not to drape the cord over the countertop or table where it can be pulled on by children or tripped over accidentally.

Notes:

1. If you have any questions about the grounding or electrical instructions, consult a qualified electrician or service person.
2. Neither Sharp nor the dealer can accept any liability for damage to the oven or personal injury resulting from failure to observe the correct electrical connection procedures.

## Radio or TV Interference

Should there be any interference caused by the microwave oven to your radio or TV, check that the microwave oven is on a different electrical circuit, relocate the radio or TV as far away from the oven as feasible or check position

### Permanent and Correct Installation

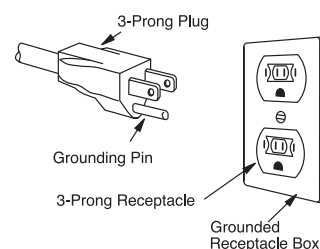

### Temporary Use

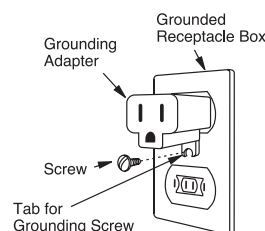

# INFORMATION YOU NEED TO KNOW

## ABOUT YOUR OVEN

This Operation Manual is valuable: read it carefully and always save it for reference.

A good microwave cookbook is a valuable asset. Check it for microwave cooking principles, techniques, hints and recipes. See pages 19 and 20 for ordering the Sharp Carousel Microwave Cookbook.

**NEVER** use the oven without the turntable and support nor turn the turntable over so that a large dish could be placed in the oven. The turntable will turn both clockwise and counterclockwise.

**ALWAYS** have food in the oven when it is on to absorb the microwave energy.

When using the oven at power levels below 100%, you may hear the magnetron cycling on and off. It is normal

for the exterior of the oven to be warm to the touch when cooking or reheating.

Condensation is a normal part of microwave cooking. Room humidity and the moisture in food will influence the amount of moisture that condenses in the oven. Generally, covered foods will not cause as much condensation as uncovered ones. Vents on the oven back must not be blocked.

The oven is for food preparation only. It should not be used to dry clothes or newspapers.

Your oven is rated 1200 watts by using the IEC Test Procedure method. In using recipes or package directions, check food a minute or two before the minimum time and add time accordingly.

## ABOUT FOOD

FOOD	DO	DON'T
Eggs, sausages, nuts, seeds, fruits & vegetables	<ul style="list-style-type: none"><li>• Puncture egg yolks before cooking to prevent "explosion".</li><li>• Pierce skins of potatoes, apples, squash, hot dogs and sausages so that steam escapes.</li></ul>	<ul style="list-style-type: none"><li>• Cook eggs in shells.</li><li>• Reheat whole eggs.</li><li>• Dry nuts or seeds in shells.</li></ul>
Popcorn	<ul style="list-style-type: none"><li>• Use specially bagged popcorn for the microwave oven.</li><li>• Listen while popping corn for the popping to slow to 1 or 2 seconds or use special <b>POPCORN</b> pad.</li></ul>	<ul style="list-style-type: none"><li>• Pop popcorn in regular brown bags or glass bowls.</li><li>• Exceed maximum time on popcorn package.</li></ul>
Baby food	<ul style="list-style-type: none"><li>• Transfer baby food to small dish and heat carefully, stirring often. Check temperature before serving.</li><li>• Put nipples on bottles after heating and shake thoroughly. "Wrist" test before feeding.</li></ul>	<ul style="list-style-type: none"><li>• Heat disposable bottles.</li><li>• Heat bottles with nipples on.</li><li>• Heat baby food in original jars.</li></ul>
General	<ul style="list-style-type: none"><li>• Cut baked goods with filling after heating to release steam and avoid burns.</li><li>• Stir liquids briskly before and after heating to avoid "eruption".</li><li>• Use deep bowl, when cooking liquids or cereals, to prevent boilovers.</li></ul>	<ul style="list-style-type: none"><li>• Heat or cook in closed glass jars or air tight containers.</li><li>• Can in the microwave as harmful bacteria may not be destroyed.</li><li>• Deep fat fry.</li><li>• Dry wood, gourds, herbs or wet papers.</li></ul>

## ABOUT UTENSILS AND COVERINGS

It is not necessary to buy all new cookware. Many pieces already in your kitchen can be used successfully in your new microwave oven. Make sure the utensil does not touch the interior walls during cooking.

### Use these utensils for safe microwave cooking and reheating:

- glass ceramic (Pyroceram®), such as Corningware®.
- heat-resistant glass (Pyrex®)
- microwave-safe plastics
- paper plates
- microwave-safe pottery, stoneware and porcelain
- browning dish (Do not exceed recommended preheating time. Follow manufacturer's directions.)

### These items can be used for short time reheating of foods that have little fat or sugar in them:

- wood, straw, wicker

### DO NOT USE

- metal pans and bakeware
- dishes with metallic trim
- non-heat-resistant glass
- non-microwave-safe plastics (margarine tubs)
- recycled paper products
- brown paper bags
- food storage bags
- metal twist-ties

Should you wish to check if a dish is safe for microwaving, place the empty dish in the oven and microwave on HIGH for 30 seconds. A dish which becomes very hot should not be used.

## ABOUT CHILDREN AND THE MICROWAVE

Children below the age of 7 should use the microwave oven with a supervising person very near to them. Between the ages of 7 and 12, the supervising person should be in the same room.

The child must be able to reach the oven comfortably; if not, he/she should stand on a sturdy stool.

At no time should anyone be allowed to lean or swing on the oven door.

### The following coverings are ideal:

- Paper towels are good for covering foods for reheating and absorbing fat while cooking bacon.
- Wax paper can be used for cooking and reheating.
- Plastic wrap that is specially marked for microwave use can be used for cooking and reheating. DO NOT allow plastic wrap to touch food. Vent so steam can escape.
- Lids that are microwave-safe are a good choice because heat is kept near the food to hasten cooking.
- Oven cooking bags are good for large meats or foods that need tenderizing. DO NOT use metal twist ties. Remember to slit bag so steam can escape.

### How to use aluminum foil in your microwave oven:

- Small flat pieces of aluminum foil placed smoothly on the food can be used to shield areas that are either defrosting or cooking too quickly.
- Foil should not come closer than one inch to any surface of the oven.

Should you have questions about utensils or coverings, check a good microwave cookbook or follow recipe suggestions.

**ACCESSORIES** There are many microwave accessories available for purchase. Evaluate carefully before you purchase so that they meet your needs. A microwave-safe thermometer will assist you in determining correct doneness and assure you that foods have been cooked to safe temperatures. Sharp is not responsible for any damage to the oven when accessories are used.

Children should be taught all safety precautions: use potholders, remove coverings carefully, pay special attention to packages that crisp food because they may be extra hot.

Don't assume that because a child has mastered one cooking skill he/she can cook everything.

Children need to learn that the microwave oven is not a toy. See page 17 for Child Lock feature.

## ABOUT MICROWAVE COOKING

- Arrange food carefully. Place thickest areas towards outside of dish.
- Watch cooking time. Cook for the shortest amount of time indicated and add more as needed. Food severely overcooked can smoke or ignite.
- Cover foods while cooking. Check recipe or cook-book for suggestions: paper towels, wax paper, microwave plastic wrap or a lid. Covers prevent spattering and help foods to cook evenly.
- Shield with small flat pieces of aluminum foil any thin areas of meat or poultry to prevent overcooking before dense, thick areas are cooked thoroughly.
- Stir foods from outside to center of dish once or twice during cooking, if possible.
- Turn foods over once during microwaving to speed cooking of such foods as chicken and hamburgers. Large items like roasts must be turned over at least once.
- Rearrange foods such as meatballs halfway through cooking both from top to bottom and from the center of the dish to the outside.
- Add standing time. Remove food from oven and stir, if possible. Cover for standing time which allows the food to finish cooking without overcooking.
- Check for doneness. Look for signs indicating that cooking temperatures have been reached.

### Doneness signs include:

- Food steams throughout, not just at edge.
- Center bottom of dish is very hot to the touch.
- Poultry thigh joints move easily.
- Meat and poultry show no pinkness.
- Fish is opaque and flakes easily with a fork.

## ABOUT SAFETY

- Check foods to see that they are cooked to the United States Department of Agriculture's recommended temperatures.
- ALWAYS use potholders to prevent burns when handling utensils that are in contact with hot food. Enough heat from the food can transfer through utensils to cause skin burns.
- Avoid steam burns by directing steam away from the face and hands. Slowly lift the farthest edge of a dish's covering and carefully open popcorn and oven cooking bags away from the face.
- Stay near the oven while it's in use and check cooking progress frequently so that there is no chance of overcooking food.
- NEVER use the cavity for storing cookbooks or other items.
- Select, store and handle food carefully to preserve its high quality and minimize the spread of foodborne bacteria.
- Keep waveguide cover clean. Food residue can cause arcing and/or fires.
- Use care when removing items from the oven so that the utensil, your clothes or accessories do not touch the safety door latches.

TEMP	FOOD
145°F (63°C)	...for beef, lamb or veal cut into steaks chops or roasts MEDIUM RARE
160°F (71°C)	...for fresh pork, ground meat, boneless white poultry, fish, seafood, egg dishes, frozen prepared food and beef, lamb or veal cut into steaks, chops or roasts cooked to MEDIUM
165°F (74°C)	...for leftover, ready-to-reheat refrigerated, deli and carry out "fresh" food, whole chicken or turkey, chicken or turkey breasts and ground poultry used in chicken or turkey burgers. NOTE: Do not cook whole, stuffed poultry. Cook stuffing separately to 165°F.

To test for doneness, insert a meat thermometer in a thick or dense area away from fat or bone. NEVER leave the thermometer in the food during cooking, unless it is approved for microwave oven use.



# PART NAMES

## MICROWAVE OVEN PARTS

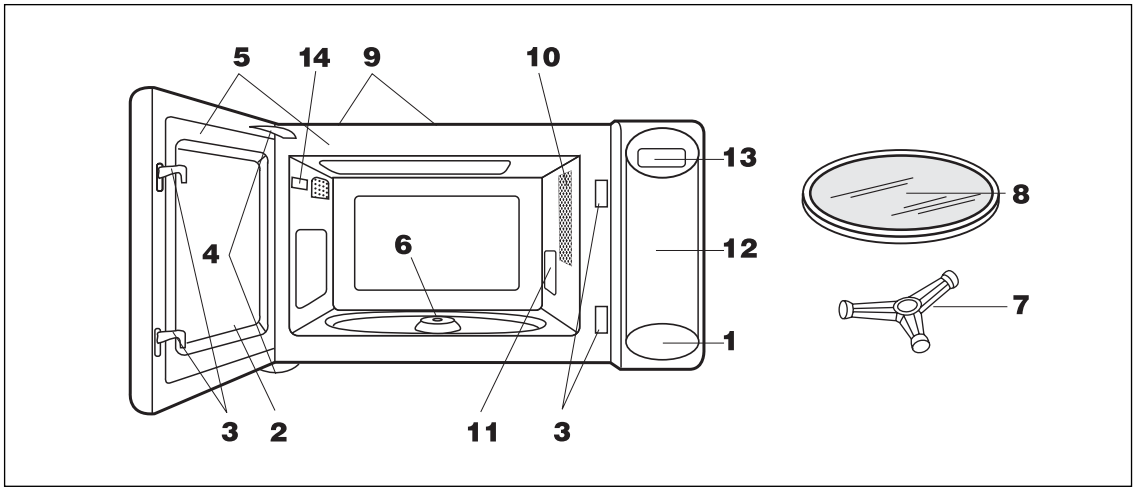

- 1** One touch door open button  
Push to open door.
- 2** Oven door with see-through window
- 3** Safety door latches  
The oven will not operate unless the door is securely closed.
- 4** Door hinges
- 5** Door seals and sealing surfaces
- 6** Turntable motor shaft
- 7** Removable turntable support  
Carefully place the turntable support in the center of the oven floor.
- 8** Removable turntable  
Place the turntable on the turntable support securely. The turntable will rotate clockwise or counterclockwise. Only remove for cleaning.
- 9** Ventilation openings (Rear)
- 10** Oven light  
It will light when oven is operating or door is open.
- 11** Waveguide cover: DO NOT REMOVE.
- 12** Auto-Touch control panel
- 13** Time display: 99 minutes, 99 seconds
- 14** Name plate

## INTERACTIVE DISPLAY

The Interactive Display spells out operating steps and shows cooking hints. When HELP is lighted in the display, touch the CUSTOM HELP pad to read a specific hint which may assist you.

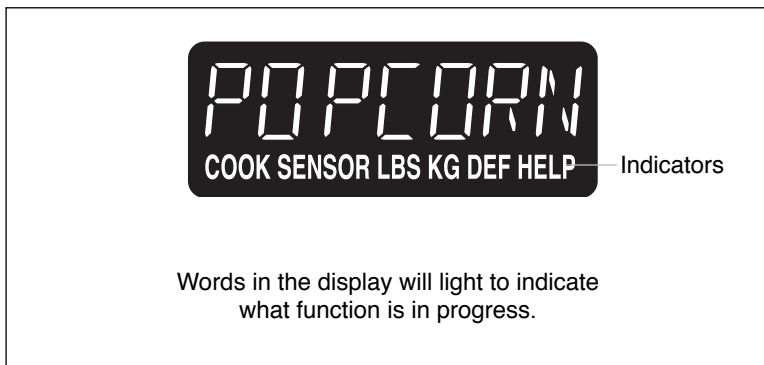

## CONTROL PANEL

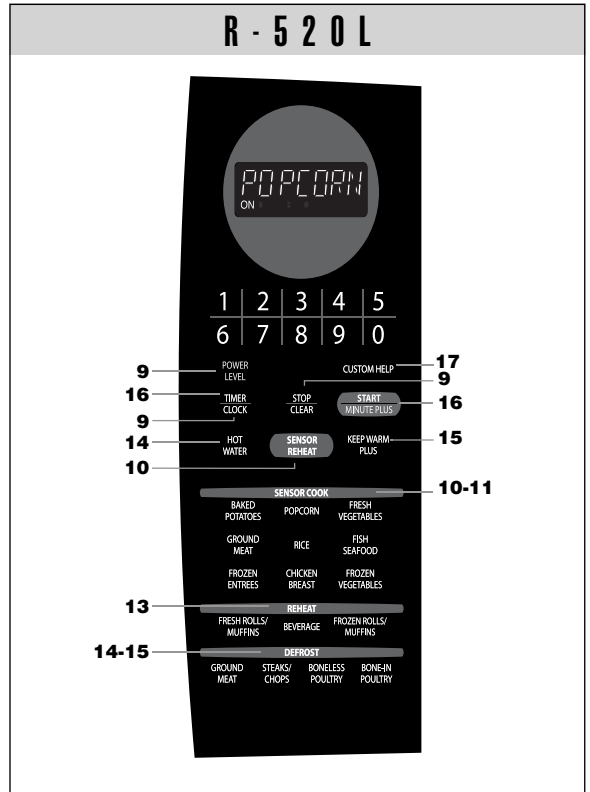
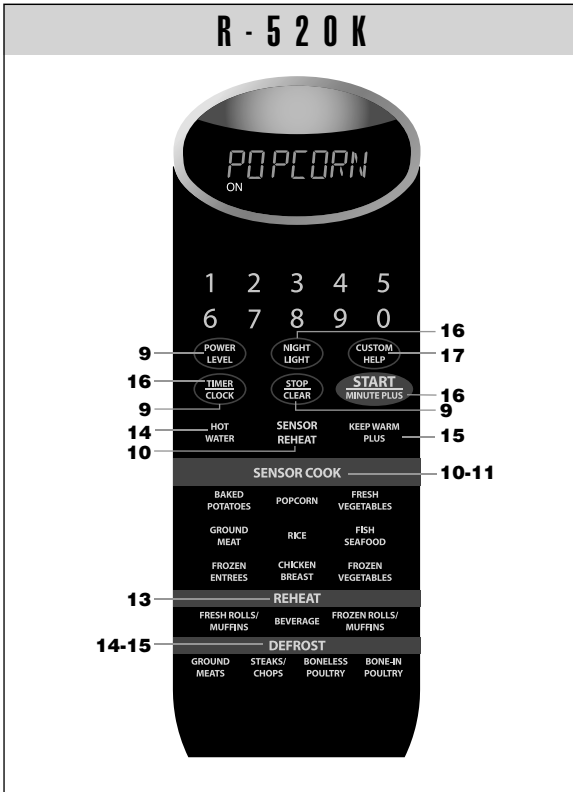

Number next to the control panel illustration indicates pages on which there are feature descriptions and usage information.

# BEFORE OPERATING

- Before operating your new microwave oven make sure you read and understand this operation manual completely.
- Before the oven can be used, follow these procedures:
  1. Plug in the oven. Close the door. The oven display will show **ENJOY YOUR OVEN PRESS CLEAR** AND **PRESS CLOCK**.
  2. Touch the **STOP/CLEAR** pad. **:** will appear.
  3. Set clock.

## TO SET THE CLOCK

- Suppose you want to enter the correct time of day 12:30 (A.M. or P.M.).

PROCEDURE	DISPLAY
<b>1</b> <b>TIMER/CLOCK</b> <b>2</b> Touch <b>TIMER/CLOCK</b> pad and number 2.	<b>ENTER</b> <b>TIME</b>
<b>2</b> <b>1 2 3 0</b> Enter the correct time of day by touching the numbers in sequence.	<b>12:30</b>
<b>3</b> <b>TIMER/CLOCK</b> Touch <b>TIMER/CLOCK</b> pad again.	<b>12:30</b>

This is a 12 hour clock. If you attempt to enter an incorrect clock time, **ERROR** will appear in the display. Touch the **STOP/CLEAR** pad and re-enter the time.

- If the electrical power supply to your microwave oven should be interrupted, the display will intermittently show **ENJOY YOUR OVEN PRESS CLEAR** AND **PRESS CLOCK** after the power is reinstated. If this occurs during cooking, the program will be erased. The time of day will also be erased. Simply touch **STOP/CLEAR** pad and reset the clock for the correct time of day.

## STOP/CLEAR

Touch the **STOP/CLEAR** pad to:

1. Erase if you make a mistake during programming.
2. Cancel timer.
3. Stop the oven temporarily during cooking.
4. Return the time of day to the display.
5. Cancel a program during cooking, touch twice.

# MANUAL OPERATION

## TIME COOKING

Your oven can be programmed for 99 minutes 99 seconds (99.99). Always enter the seconds after the minutes, even if they are both zeros.

- Suppose you want to cook for 5 minutes at 100%.

PROCEDURE	DISPLAY
<b>1</b> <b>5 0 0</b> Enter cooking time.	<b>5.00</b>
<b>2</b> <b>START MINUTE PLUS</b> Touch <b>START/MINUTE PLUS</b> pad.	<b>5.00</b> <small>COOK</small>

## TO SET POWER LEVEL

There are eleven preset power levels.

Using lower power levels increases the cooking time which is recommended for foods such as cheese, milk and long slow cooking of meats. Consult cookbook or recipes for specific recommendations.

TOUCH POWER LEVEL PAD NUMBER OF TIMES FOR DESIRED POWER	APPROXIMATE PERCENTAGE OF POWER	COMMON WORDS FOR POWER LEVELS
POWER LEVEL x 1	100%	High
POWER LEVEL x 2	90%	
POWER LEVEL x 3	80%	
POWER LEVEL x 4	70%	Medium High
POWER LEVEL x 5	60%	
POWER LEVEL x 6	50%	Medium
POWER LEVEL x 7	40%	
POWER LEVEL x 8	30%	Med Low/Defrost
POWER LEVEL x 9	20%	
POWER LEVEL x 10	10%	Low
POWER LEVEL x 11	0%	

- Suppose you want to defrost for 5 minutes at 30%.

PROCEDURE	DISPLAY
<b>1</b> <b>5 0 0</b> Enter defrosting time.	<b>5.00</b>
<b>2</b> <b>POWER LEVEL</b> x 8 Touch <b>POWER LEVEL</b> pad eight times or hold down until the desired power level appears.	<b>P-30</b>
<b>3</b> <b>START MINUTE PLUS</b> Touch <b>START/MINUTE PLUS</b> pad. When the defrost time is complete, a long tone will sound and <b>END</b> will appear in the display.	<b>5.00</b> <small>COOK</small>

# SPECIAL FEATURES

## SENSOR COOK

Sharp's Sensor is a semi-conductor device that detects the vapor (moisture and humidity) emitted from the food as it heats. The sensor adjusts the cooking times and power level for various foods and quantities.

### Using Sensor Settings:

1. After the oven is plugged in, wait 2 minutes before using Sensor Cook.
2. Be sure the exterior of the cooking container and the interior of the oven are dry. Wipe off any moisture with a dry cloth or paper towel.
3. The oven works with foods at normal storage temperature. For example, popcorn would be at room temperature.
4. Any Sensor Cook selection can be programmed with More or Less Time Adjustment. See page 16.
5. More or less food than the quantity listed in the chart should be cooked following the guidelines in any microwave cookbook.
6. During the first part of Sensor Cook, the food name will appear on the display. Do not open the oven door or touch **STOP/CLEAR** during this part of the cooking cycle. The measurement of vapor will be interrupted. If this occurs, an error message will appear. To continue cooking, touch the **STOP/CLEAR** pad and cook manually.  
  
When the sensor detects the vapor emitted from the food, the remainder of cooking time will appear. The door may be opened when remaining cooking time appears on the display. At this time, you may stir or season food, as desired.
7. If the sensor does not detect vapor properly when popping popcorn, the oven will turn off, and the correct time of day will be displayed. If the sensor does not detect vapor properly when cooking other foods, **ERROR** will be displayed, and the oven will turn off.

8. Check food for temperature or doneness after cooking. **If food is not completely cooked, enter additional cooking time manually.** Do not press Sensor Cook again as food may overcook.
9. Each food has a cooking hint. Touch the **CUSTOM HELP** pad when the HELP indicator is lighted in the display.

### Covering Foods:

Some foods work best when covered. Use the cover recommended in the Sensor Cook chart for these foods.

1. Casserole lid.
2. Plastic wrap: Use plastic wrap recommended for microwave cooking. Cover dish loosely; allow approximately 1/2 inch to remain uncovered to allow steam to escape. Plastic wrap should not touch food.
3. Wax paper: Cover dish completely; fold excess wrap under dish to secure. If dish is wider than paper, overlap two pieces at least one inch to cover.

Be careful when removing any covering to allow steam to escape away from you.

### EXAMPLE:

You can cook many foods by touching any Sensor pad and **START/MINUTE PLUS**. You don't need to calculate cooking time or power level.

- Suppose you want to reheat canned chili.

### PROCEDURE

- 1 Touch **SENSOR REHEAT** pad.

**SENSOR  
REHEAT**

When the sensor detects the vapor emitted from the food, the remainder of cooking time will appear.

## SENSOR COOK CHART

FOOD	AMOUNT	PROCEDURE
SENSOR REHEAT	4 - 36 oz	Place in dish or casserole slightly larger than amount to be reheated. Flatten, if possible. Cover with lid, plastic wrap or wax paper. Use covers such as plastic wrap or lids with larger quantities of more dense foods such as stews. After reheating, stir well, if possible. Re-cover and allow to stand 2 to 3 minutes. Foods should be very hot. If not, continue to heat with variable power and time.
BAKED POTATOES	1 - 8 med.	Pierce. Place on paper-towel-lined turntable. After cooking, remove from oven, wrap in aluminum foil and let stand 5 to 10 minutes.
POPCORN	1 package 1.5 - 3.5 oz bag	Use only popcorn packaged for the microwave. Try several brands to decide which you like. Do not try to pop unpopped kernels.

# SPECIAL FEATURES

## SENSOR COOK CHART (continued)

FOOD	AMOUNT	PROCEDURE															
<b>FRESH VEGETABLES: Soft</b>																	
Broccoli	.25 - 2.0 lb	Wash and place in casserole. Add no water if vegetables have just been washed. Cover with lid for tender vegetables. Use plastic wrap for tender-crisp vegetables. Touch <b>FRESH VEGETABLES</b> pad. After cooking, stir, if possible. Let stand, covered, for 2 to 5 minutes.															
Brussels sprouts	.25 - 2.0 lb																
Cabbage	.25 - 2.0 lb																
Caulif. (flowerets)	.25 - 2.0 lb																
Cauliflower (whole)	1 med.																
Spinach	.25 - 1.0 lb																
Zucchini	.25 - 2.0 lb																
Baked apples	2 - 4 med.																
<b>FRESH VEGETABLES: Hard</b>																	
Carrots, sliced	.25 - 1.5 lb	Place in casserole. Add 1-4 tbsp water. Cover with lid for tender vegetables. Use plastic wrap cover for tender-crisp vegetables. Touch <b>FRESH VEGETABLES</b> pad twice. After cooking, stir, if possible. Let stand, covered, for 2 to 5 minutes.															
Corn on the cob	2 - 4																
Green beans	.25 - 1.5 lb																
Winter squash:																	
diced	.25 - 1.5 lb																
halves	1 - 2																
<b>GROUND MEAT</b>	.25 - 2.0 lb	Use this setting to cook ground beef or turkey as patties or in a casserole to be added to other ingredients. Place patties on a microwave-safe rack and cover with wax paper. Place ground meat in a casserole and cover with wax paper or plastic wrap. When oven stops, turn patties over or stir meat in casserole to break up large pieces. Re-cover and touch the <b>START/MINUTE PLUS</b> . After cooking, let stand, covered, for 2 to 3 minutes.															
<b>RICE</b>	.5 - 2.0 cups	Place rice into a deep casserole and add double quantity of water. Cover with lid or plastic wrap. After cooking, stir, cover and let stand 3 to 5 minutes or until all liquid has been absorbed.															
		<table border="1"> <thead> <tr> <th>Rice</th> <th>Water</th> <th>Size of casserole</th> </tr> </thead> <tbody> <tr> <td>.5 cup</td> <td>1 cup</td> <td>1.5 quart</td> </tr> <tr> <td>1 cup</td> <td>2 cups</td> <td>2 quart</td> </tr> <tr> <td>1.5 cups</td> <td>3 cups</td> <td>2.5 or 3 quart</td> </tr> <tr> <td>2 cups</td> <td>4 cups</td> <td>3 quart or larger</td> </tr> </tbody> </table>	Rice	Water	Size of casserole	.5 cup	1 cup	1.5 quart	1 cup	2 cups	2 quart	1.5 cups	3 cups	2.5 or 3 quart	2 cups	4 cups	3 quart or larger
Rice	Water	Size of casserole															
.5 cup	1 cup	1.5 quart															
1 cup	2 cups	2 quart															
1.5 cups	3 cups	2.5 or 3 quart															
2 cups	4 cups	3 quart or larger															
<b>FISH &amp; SEAFOOD</b>	.25 - 2.0 lb	Arrange in ring around shallow glass dish (roll fillet with edges underneath). Cover with plastic wrap. After cooking, let stand, covered, 3 minutes.															
<b>FROZEN ENTREES</b>	6 - 17 oz	Use this pad for frozen, convenience foods. It will give satisfactory results for most brands. You may wish to try several and choose your favorite. Remove package from outer wrapping and follow package directions for covering. After cooking, let stand, covered for 1 to 3 minutes.															
<b>CHICKEN BREAST</b>	.5 - 2.0 lb	Cover with vented plastic wrap. When oven stops, turn over. Shield with small, flat pieces of aluminum foil any areas that are cooking too rapidly. Re-cover and touch <b>START/MINUTE PLUS</b> . After cooking, let stand, covered 3-5 minutes. Chicken should be 165°F.															
<b>FROZEN VEGETABLES</b>	.25 - 1.5 lb	Do not add water. Cover with lid or plastic wrap. After cooking, stir and let stand, covered, for 3 minutes.															

## SENSOR COOK RECIPES

### Glazed Apple Slices

Makes 6 to 8 servings

- |                                   |  |
|-----------------------------------|--|
| 1/4 cup brown sugar               | 3/4 cup orange juice   |
| 3 tablespoons margarine or butter | 1 tablespoon cornstarch  |
| 2 tablespoons apricot preserves   | 4 baking apples (about 1 1/2 pounds), peeled and sliced into 8 pieces each |
| 1/2 teaspoon ground nutmeg        | 3 tablespoons chopped green pistachios                                     |
| 1/4 teaspoon salt                 |  |
| 1/2 cup sugar                     |  |

- 1 Combine brown sugar, margarine and apricot preserves in a small bowl. Microwave at HIGH (100%) until margarine melts and preserves soften, 45 seconds to 1 minute. Stir in nutmeg, salt, sugar, orange juice and cornstarch. Microwave at HIGH (100%) until thickened, 4 to 6 minutes, stirring several times.
- 2 Arrange apple slices in a large microwave serving dish. Spread hot sauce over apples. Cover well with vented plastic wrap. Microwave using **FRESH VEGETABLES**: Soft. Allow to cool 5 minutes before serving.
- 3 Sprinkle with pistachios. Serve alone or over vanilla ice cream or sponge cake.

### Confetti Soup

Makes 6 servings

- |  |                                    |
|--|------------------------------------|
| 3 tablespoons butter or margarine                | 1 teaspoon salt                    |
| 1 cup cubed carrots, 1/4-inch cubes              | 1/2 teaspoon pepper                |
| 1 cup rutabaga, 1/4-inch cubes                   | 1/4 teaspoon sugar                 |
| 1 small zucchini, 1/4-inch cubes                 | 4 cups milk                        |
| 1/2 cup chopped onion                            | 1 cup shredded Cheddar cheese      |
| 1/2 cup chopped celery                           | 1 cup frozen corn, thawed          |
| 1 cup fresh broccoli flowerets or cauliflowerets | 1/2 cup cooked ham, 1/4-inch cubes |
| 1/4 cup all-purpose flour                        | 1/2 cup frozen peas, thawed        |

- 1 Combine butter, carrots, rutabaga, zucchini, onion, celery and broccoli in 3-quart, covered casserole.
- 2 Microwave using **FRESH VEGETABLES**: Soft. Stir well.
- 3 Stir in flour, salt, pepper, sugar, milk, cheese, corn, ham and peas.
- 4 Microwave using **SENSOR REHEAT**. Stir well and serve with croutons.

### Mixed Company Vegetables

Makes 8 servings

- |   |   |
|---|---|
| 3 green onions, diagonally cut into 1-inch pieces | 3/4 pound carrots, cut into 1/4-inch thick slices       |
| 1 teaspoon minced garlic                          | 1 bunch of broccoli, cut into 2-inch by 1-inch pieces   |
| 1/4 teaspoon crushed red pepper                   | 1 medium red pepper, sliced into matchstick-thin strips |
| 2 tablespoons olive oil                           | 1/2 pound medium mushrooms, sliced                      |
| 2 tablespoons teriyaki sauce                      |   |

- 1 In a small, microwave-safe bowl, combine green onions, garlic, crushed red pepper and oil. Microwave on HIGH (100%) for 2 minutes. Stir in teriyaki sauce.
- 2 In a 3-quart casserole, place carrots, broccoli, red peppers and mushrooms. Cover with plastic wrap.
- 3 Microwave using **FRESH VEGETABLES**: Soft for tender crisp or **FRESH VEGETABLES**: Hard for softer vegetables.
- 4 Remove from oven and drain. Add green onion mixture and stir to combine. Serve immediately.

# SPECIAL FEATURES

## REHEAT

REHEAT allows you to heat many of your favorite foods.

- Suppose you want to heat 2 fresh rolls or muffins.

PROCEDURE	DISPLAY
<b>1</b> <b>FRESH ROLLS/ MUFFINS</b> x 2	<b>2 PCS</b> HELP

Select desired setting. Touch **FRESH ROLLS/MUFFINS** pad 2 times. The oven starts automatically.

### NOTE:

1. To increase quantity, touch chosen pad until number in display is same as desired quantity to heat. Ex: touch **BEVERAGE** three times for 1.5 cups. More or less food than the quantity listed in the chart should be heated following the guidelines in any microwave cookbook.
2. The Reheat selections can be programmed with More or Less Time Adjustment. See page 16.
3. The final result will vary according to the food condition (e.g. initial temperature, shape, quality). Check food temperature after heating. If additional time is needed, continue to heat manually.

## REHEAT CHART

FOOD	AMOUNT	PROCEDURE								
FRESH ROLLS/MUFFINS	1 - 10	Use this pad to warm rolls, muffins, biscuits, bagels etc. Large items should be considered as 2 or 3 regular size. Arrange on plate; cover with paper towel. For refrigerated rolls or muffins, it may be necessary to double the entered amount to ensure the proper serving temperature. For example, enter quantity of 2 for 1 refrigerated muffin.								
BEVERAGE	.5 - 2.0 cups	This setting is good for restoring cooled beverage to a better drinking temperature. Stir liquid briskly before and after heating to avoid "eruption".								
<b>Press the pad for amount (cups).</b>										
<table border="1"> <tbody> <tr> <td>Once</td> <td>.5</td> </tr> <tr> <td>Twice</td> <td>1.0</td> </tr> <tr> <td>3 times</td> <td>1.5</td> </tr> <tr> <td>4 times</td> <td>2.0</td> </tr> </tbody> </table>			Once	.5	Twice	1.0	3 times	1.5	4 times	2.0
Once	.5									
Twice	1.0									
3 times	1.5									
4 times	2.0									
FROZEN ROLLS/MUFFINS	1 - 10	Use this pad to warm rolls, muffins, biscuits, bagels etc. Large items should be considered as 2 or 3 regular size. Arrange on plate; cover with paper towel.								

# SPECIAL FEATURES

## DEFROST

DEFROST automatically defrosts all the foods shown in the DEFROST CHART on page 15.

Round the weight to the nearest half pound. (Ex: if the steak's actual weight is 2.2 lb round to 2.0 lb If the steak's weight is 2.4 lb round to 2.5 lb.)

To enter weight, touch the desired Defrost pad for a 0.5 lb increase per touch. (Ex: touch four times for 2.0 lb.)

- Suppose you want to defrost a 2.0 pound steak .

PROCEDURE	DISPLAY
<b>1</b> <b>STEAKS/CHOPS</b> x 4 Touch <b>STEAKS/CHOPS</b> pad 4 times for 2.0 lb. The oven will start automatically.	
The oven will stop and directions will be displayed. Follow the indicated message.	
<b>2</b> After the 1st stage, open the door, turn steak over and shield any warm portions. Close the door. <b>START MINUTE PLUS</b> Touch <b>START/MINUTE PLUS</b> pad.	
<b>3</b> After the 2nd stage, open the door and shield any warm portions. Close the door. <b>START MINUTE PLUS</b> Touch <b>START/MINUTE PLUS</b> pad.	
<b>4</b> After defrost cycle ends, cover and let stand as indicated in chart.	

### NOTE:

1. If you attempt to enter more or less than the allowed weight as indicated in chart on page 15, **ERROR** will appear in the display.
2. The Defrost foods can be programmed with More or Less Time Adjustment. Touch the **POWER LEVEL** pad once or twice after selecting the weight. See page 16.
3. To defrost other foods or foods above or below the weights allowed on DEFROST CHART on page 15 use time and 30% power. See MANUAL DEFROST on the next column.
4. You may choose to enter the weight in tenths of pounds. This procedure may be easier with larger weights, such as 3 pounds, because it requires fewer touches. To program, touch desired Defrost pad and enter weight by touching the number pads. Ex: touch **STEAKS/CHOPS** then **3** and **0** for a weight of three pounds or touch **STEAKS/CHOPS** then **2** and **2** for a weight of 2.2 lb.

## MANUAL DEFROST

If the food that you wish to defrost is not listed on the DEFROST CHART or is above or below the limits in the Amount column on the DEFROST CHART (see page 15), you need to defrost manually.

You can defrost any frozen food, either raw or previously cooked, by using **POWER LEVEL** for 30%. Follow the exact 3-step procedure found under, **TO SET POWER LEVEL** on page 9. Estimate defrosting time and press **POWER LEVEL** pad eight times for 30% power.

For either raw or previously cooked frozen food the rule of thumb is approximately 4 minutes per pound. For example, defrost 4 minutes for 1 pound of frozen spaghetti sauce.

Always stop the oven periodically to remove or separate the portions that are defrosted. If food is not defrosted at the end of the estimated defrosting time, program the oven in 1 minute increments on Power Level 30% until totally defrosted.

When using plastic containers from the freezer, defrost only long enough to remove from the plastic in order to place in a microwave-safe dish.

## HOT WATER

**HOT WATER** heats 1 to 6 cups of tap water to prepare coffee, tea, bouillon and instant soup as well as heat the water to cook pasta. When preparing individual cups, place instant coffee, tea or bouillon in cup and stir before heating. Allow to stand 20 seconds after heating before stirring and drinking. Stir carefully after removing from the oven. When heating 6 cups of water, place in large casserole and cover with lid or plastic wrap. When oven signals, add pasta and continue cooking according to package directions. Touch **HOT WATER** pad once for each cup up to 6.

- Suppose you want to heat 3 cups of water.

PROCEDURE
<b>1</b> Touch <b>HOT WATER</b> pad 3 times. The oven starts automatically.



# SPECIAL FEATURES

## DEFROST CHART

FOOD	AMOUNT	PROCEDURE
GROUND MEAT	.5 - 2.0 lb	Remove any thawed pieces after each stage. Let stand, covered, for 5 to 10 minutes.
STEAKS/ CHOPS	.5 - 3.0 lb	After each stage, rearrange and if there are warm or thawed portions, shield with small flat pieces of aluminum foil. Remove any meat or fish that is nearly defrosted. Let stand, covered, for 10 to 20 minutes.
BONELESS POULTRY	.5 - 2.0 lb	After each stage, if there are warm or thawed portions, rearrange or remove. Let stand, covered, for 10 to 20 minutes.
BONE-IN POULTRY	.5 - 3.0 lb	Arrange pieces with meatiest portions toward outside of glass dish or microwave safe rack. After each stage, if there are warm or thawed portions, rearrange or remove. Let stand, covered, for 10 to 20 minutes.

**NOTE:** Check foods when oven signals. After final stage, small sections may still be icy. Let stand to continue thawing. Do not defrost until all ice crystals are thawed.

Shielding prevents cooking from occurring before the center of the food is defrosted. Use small smooth strips of aluminum foil to cover edges and thinner sections of the food.

## KEEP WARM PLUS

KEEP WARM PLUS allows you to keep food warm up to 30 minutes.

### DIRECT USE

- Suppose you want to keep a cup of soup warm for 15 minutes.





PROCEDURE	
<b>1</b> Touch <b>KEEP WARM PLUS</b> pad.	
<b>2</b> Enter the desired time.	
<b>3</b> Touch <b>START/ MINUTE PLUS</b> pad.	



The oven will start. The display will show  and count down.   will be displayed during the count down.

You can program Keep Warm Plus with manual cooking to keep food warm after cooking.

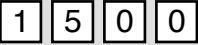
### WITH MANUAL COOKING

- Suppose you want to cook a cup of soup for 2 minutes at 70% and keep the soup warm for 15 minutes.

PROCEDURE	
<b>1</b> Enter cooking time.	
<b>2</b> Touch <b>POWER LEVEL</b> pad 4 times for 70% power.	 x 4
<b>3</b> Touch <b>KEEP WARM PLUS</b> pad.	
<b>4</b> Enter the desired time.	
<b>5</b> Touch <b>START/ MINUTE PLUS</b> pad.	

The operation will start. When the cooking time is complete, a long tone will sound and Keep Warm Plus will start. The display will count down for 15 minutes and   will be displayed during the count down.







### NOTE:

Keep Warm Plus cannot be programmed with Special Features.

# OTHER CONVENIENT FEATURES

## TIMER

- Suppose you want to time a 3 minute long distance phone call.

PROCEDURE	
<b>1</b> Touch <b>TIMER/CLOCK</b> pad and number 1.	 
<b>2</b> Enter time.	  
<b>3</b> Touch <b>TIMER/CLOCK</b> pad.	

## MINUTE PLUS

MINUTE PLUS allows you to cook for a minute at 100% by simply touching the **MINUTE PLUS** pad. You can also extend cooking time in multiples of 1 minute by repeatedly touching the **MINUTE PLUS** pad during manual cooking.

- Suppose you want to heat a cup of soup for one minute.

PROCEDURE	
<b>1</b> Touch <b>START/MINUTE PLUS</b> pad.	

### NOTE:

1. To use Minute Plus, touch pad within 3 minutes after cooking, closing the door, touching the **STOP/CLEAR** pad or during cooking.
2. Minute Plus cannot be used with Special Features.

## MORE OR LESS TIME ADJUSTMENT

Should you discover that you like any of the **SENSOR REHEAT**, **SENSOR COOK**, **REHEAT** or **DEFROST** settings slightly **more** done, touch the **POWER LEVEL** pad once after touching your choice of pads.





The display will show .

Should you discover that you like any of the **SENSOR REHEAT**, **SENSOR COOK**, **REHEAT** or **DEFROST** settings slightly **less** done, touch the **POWER LEVEL** pad twice after touching your choice of pads.

The display will show .

The **POWER LEVEL** pad must be touched within 1 second of touching your choice of pads.

## DEMONSTRATION MODE

To demonstrate, touch **TIMER/CLOCK**, the number , then touch **START/MINUTE PLUS** and hold for 3 seconds.   will appear in the display. Cooking operations and specific special features can now be demonstrated with no power in the oven. For example, touch **MINUTE PLUS** and the display will show  and count down quickly to .





To cancel, touch **TIMER/CLOCK**, then the number  and **STOP/CLEAR**. If easier, unplug the oven from the electrical outlet and replug.

## MULTIPLE SEQUENCE COOKING

Your oven can be programmed for up to 4 automatic cooking sequences, switching from one power level setting to another automatically.

Sometimes cooking directions tell you to start on one power level and then change to a different power level. Your oven can do this automatically.

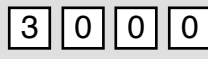
- Suppose you want to cook for 5 minutes at 100% and then continue to cook for 30 minutes at 50%.

PROCEDURE	
<b>1</b> First enter cooking time. Then touch <b>POWER LEVEL</b> pad once for 100% power.	 
<b>2</b> Enter second cooking time. Then touch <b>POWER LEVEL</b> pad 6 times for 50% power.	  x 6
<b>3</b> <b>START/MINUTE PLUS</b> pad.	

### NOTE:

If 100% is selected as the final sequence, it is not necessary to touch the **POWER LEVEL** pad.

## NIGHT LIGHT (for R-520K only)

Touch the **NIGHT LIGHT** pad once to turn on the light and touch again to turn off.

The Night Light turns off automatically when you start cooking and after the light has operated for 9 hours.

# OTHER CONVENIENT FEATURES

## CUSTOM HELP

Custom Help provides 4 features that make using your oven easy because specific instructions are provided in the interactive display.

### 1. CHILD LOCK

The Child Lock prevents unwanted oven operation such as by small children. The oven can be set so that the control panel is deactivated or locked. To set, touch **CUSTOM HELP**, the number **1** and then touch the **START/MINUTE PLUS** pad. Should a pad be touched, **CHILD LOCK ON** will appear in the display.

To cancel, touch **CUSTOM HELP** and **STOP/CLEAR** pad.

### 2. AUDIBLE SIGNAL ELIMINATION

If you wish to have the oven operate with no audible signals, touch **CUSTOM HELP**, the number **2** and touch **STOP/CLEAR**.

To cancel and restore the audible signal, touch **CUSTOM HELP**, the number **2** and touch **START/MINUTE PLUS**.

### 3. AUTO START

If you wish to program your oven to begin cooking automatically at a designated time of day, follow this procedure:

- Suppose you want to start cooking a stew for 20 minutes on 50% at 4:30. Before setting, check to make sure the clock is showing the correct time of day.

#### PROCEDURE

- 1** Touch **CUSTOM HELP** pad.



- 2** Touch number 3.



- 3** Enter the start time.



- 4** Touch **TIMER/CLOCK** pad.



- 5** Enter cooking program.

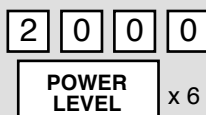

- 6** Touch **START/MINUTE PLUS** pad.



## NOTE:

- Auto Start can be used for manual cooking if clock is set.
- If the oven door is opened after programming Auto Start, it is necessary to touch the **START/MINUTE PLUS** pad for Auto Start time to appear in the readout so that the oven will automatically begin programmed cooking at the chosen Auto Start time.
- Be sure to choose foods that can be left in the oven safely until the Auto Start time. Acorn or butternut squash are often a good choice.

## 4. LANGUAGE / WEIGHT SELECTION

The oven comes set for English and U.S. Customary Unit-pounds. To change, touch **CUSTOM HELP** and the number **4**. Continue to touch the number **4** until your choice is selected from the table below. Then, touch **START/MINUTE PLUS**.

Touch number **4** for language and standard of weight.

NUMBER	LANGUAGE	STANDARD OF WEIGHT	DISPLAY
Once	English	LBS	ENGLISH Lb
Twice	English	KG	ENGLISH KG
3 times	Spanish	LBS	ESPAÑOL Lb
4 times	Spanish	KG	ESPAÑOL KG
5 times	French	LBS	FRANC. Lb
6 times	French	KG	FRANC. KG

## HELP

Each setting of **SENSOR REHEAT**, **SENSOR COOK**, **REHEAT** and **DEFROST** has a cooking hint. If you wish to check, touch **CUSTOM HELP** whenever **HELP** is lighted in the Interactive Display for these and other manual operation hints.

# CLEANING AND CARE

Disconnect the power cord before cleaning or leave the door open to inactivate the oven during cleaning.

## Exterior

The outside surface is painted. Clean the outside with mild soap and water. Then wipe with a clean dampened cloth and polish dry with a soft cloth. Do not use any type of household or abrasive cleaner.

## Door

Wipe the window on both sides with a soft damp cloth to remove any spills or splatters. Metal parts will be easier to maintain if wiped frequently with a soft damp cloth.

Cleaners which are marked specifically for use with stainless steel may be used for stainless steel models. Follow package directions exactly. Avoid the use of any harsh cleaners or one not marked for stainless steel use as they may stain, streak or dull the door surface.

## Touch Control Panel

Wipe the panel with a soft cloth dampened slightly with water only. Dry with a soft cloth. Do not scrub or use any sort of chemical cleaners. Close door and touch **STOP/CLEAR**.

## Interior

Cleaning is easy because little heat is generated to the interior surfaces; therefore, there is no baking and setting of spills or spattering. To clean the interior surfaces, wipe with a soft damp cloth. **DO NOT USE ABRASIVE OR HARSH CLEANERS OR SCOURING PADS.** For heavier soil, use baking soda or a mild soap; wipe clean with a soft damp cloth. **NEVER SPRAY OVEN CLEANERS DIRECTLY ONTO ANY PART OF THE OVEN.**

## Waveguide Cover

The waveguide cover is made from mica so it requires special care. Keep the waveguide cover clean to assure good oven performance. Carefully wipe with a soft damp cloth any food splatters from the surface of the cover immediately after they occur. Built-up splashes may overheat and cause smoke or possibly catch fire. Do not remove the waveguide cover.

## Odor Removal

Occasionally, a cooking odor may remain in the oven. To remove, combine 1 cup water, grated peel and juice of 1 lemon and several whole cloves in a 2-cup glass microwave-safe measuring cup. Boil for several minutes using 100% power. Allow to set in oven until cool. Wipe interior with a soft cloth.

## Turntable/Turntable Support

The turntable and turntable support can be removed for easy cleaning. Wash them in mild, sudsy water; for stubborn stains use a mild cleanser and non abrasive scouring sponge. They are also dishwasher-safe. Use upper rack of dishwasher. The turntable motor shaft is not sealed, so excess water or spills should be wiped up immediately.

# SERVICE CALL CHECK

Please check the following before calling for service:

Place one cup of water in a glass microwave-safe measuring cup in the oven and close the door securely. Operate the oven for one minute at HIGH 100%.

- A** Does the oven light come on? YES \_\_\_\_\_ NO \_\_\_\_\_
- B** Does the cooling fan work?  
(Put your hand over the rear ventilating openings.) YES \_\_\_\_\_ NO \_\_\_\_\_
- C** Does the turntable rotate?  
(It is normal for the turntable to turn in either direction.) YES \_\_\_\_\_ NO \_\_\_\_\_
- D** Is the water in the oven warm? YES \_\_\_\_\_ NO \_\_\_\_\_

If "NO" is the answer to any of the above questions, please check electrical outlet, fuse and/or circuit breaker. If they are functioning properly, CONTACT YOUR NEAREST SHARP AUTHORIZED SERVICER. A microwave oven should never be serviced by a "do-it-yourself" repair person.

**NOTE:** If time appearing in the display is counting down very rapidly, check Demonstration Mode on page 16 and cancel.

# COOKBOOK INFORMATION

## 125 GREAT RECIPES

- All about your microwave
- Color photos
- Step-by-step instructions
- Durable wipe-clean soft cover with 192 7" x 10" pages
- Helpful tips and special techniques

## SHARP<sup>®</sup> MICROWAVE OVEN COOKBOOK

### TO ORDER

Simply call this toll-free number: **1-800-237-4277**. Please have your credit card ready.

If you prefer to order by mail, complete and return the order form on page 20. Please include check or money order (payable to Sharp Electronics Corporation) for \$14.00 plus \$4.50 shipping & handling and tax, if applicable, per book.

### SATISFACTION GUARANTEED

You must be completely satisfied with the Sharp Microwave Oven Cookbook. If, within 14 days, you are dissatisfied for any reason, simply return the book and we'll gladly refund your \$14.00 plus tax.

(SOLAMENTE ESCRITO EN INGLES!)

# SPECIFICATIONS

## R-520K / R-520L

AC Line Voltage:	Single phase 120V, 60Hz, AC only
AC Power Required:	1700 watts, 14.3 amps.
Output Power:*	1200 watts
Frequency:	2450 MHz
Outside Dimensions:	24"(W) x 13 3/8"(H) x 19 1/8"(D)
Cavity Dimensions:	17 3/8"(W) x 10 1/2"(H) x 18 5/8"(D)
Oven Capacity:**	2.0 Cu. Ft.
Cooking Uniformity:	Turntable system, diameter 16"
Weight:	Approx. 46 lb

★ The International Electrotechnical Commission's standardized method for measuring output wattage. This test method is widely recognized.

★★ Internal capacity is calculated by measuring maximum width, depth and height. Actual capacity for holding food is less.

In compliance with standards set by:

**FCC** – Federal Communications Commission Authorized.

**DHHS** – Complies with Department of Health and Human Services (DHHS) rule, CFR, Title 21, Chapter I, Subchapter J.



– This symbol on the nameplate means the product is listed by Underwriters Laboratories, Inc.

- - - - - Cut along this line. - - - - -

## COOKBOOK ORDER FORM

Please send me \_\_\_\_\_ cookbooks at \$18.50 each \$ \_\_\_\_\_

Illinois sales tax, (if applicable) per book \$.91 no. of books \_\_\_\_\_ \$ \_\_\_\_\_

**TOTAL ORDER AMOUNT \$ \_\_\_\_\_**

I have enclosed a check made payable to Sharp Electronics Corporation.

Please bill my  VISA  MASTERCARD  AMERICAN EXPRESS

Acct. No \_\_\_\_\_ Expiration date \_\_\_\_\_ / \_\_\_\_\_

Signature \_\_\_\_\_

(All credit card orders must be signed.)

Name \_\_\_\_\_

Address \_\_\_\_\_

City \_\_\_\_\_ State \_\_\_\_\_ Zip \_\_\_\_\_

Daytime Phone No. ( \_\_\_\_\_ ) \_\_\_\_\_

Mail to: Sharp Electronics Corporation  
Attention: Customer Assistance Center  
1300 Naperville Drive  
Romeoville, IL 60446-1091

Price is subject to change without notice.

# GUIA AUTO-TOUCH

Para mayor informacion y precauciones de seguridad, consulte el Manual de Operaciones

## PARA FIJAR LA HORA

Si en la pantalla se lee **ENJOY YOUR OVEN**  
**PRESS CLEAR AND PRESS CLOCK** toque primero **STOP/CLEAR**.

**1** Toque el botón que dice **TIMER/CLOCK** y número **2**.

**2** Ajuste el reloj en la hora correcta oprimiendo los botones numéricos en el orden respectivo. (Ej: 12:30)

**3** Toque nuevamente el botón que dice **TIMER/CLOCK**.

## SENSOR REHEAT SENSOR COOK

Toque el botón **SENSOR REHEAT**. El horno empezará a funcionar automáticamente.

Cuando el sensor detecte que el alimento que está en el horno emite vapor, en la pantalla aparece el tiempo de cocción restante.

## CUADRO SENSOR COOK

ALIMENTO	CANTIDAD
Sensor de recalentar	4 a 36 onzas
Papa Asada	1 a 8 med.
Palomitas de maíz	Bolsa de 1.5 a 3.5 onzas
Plato fuerte congelado	6 a 17 onzas
Verdura congelada	.25 a 1.5 libras
Arroz	.5 a 2.0 tazas
Verdura fresca:	
Suave	.25 a 2.0 libras
Firme	.25 a 1.5 libras
Carne molida	.25 a 2.0 libras
Pechuga de pollo	.5 a 2.0 libras
Pescado, mariscos	.25 a 2.0 libras

## REHEAT

REHEAT le permite calentar muchos de sus alimentos favoritos.

ALIMENTO	CANTIDAD
Pan fresco	1 a 10
Bebida	.5 a 2.0 tazas
Pan congelado	1 a 10

## MINUTE PLUS

Toque el botón **MINUTE PLUS** por un minuto al 100% de potencia para aumentar un minuto en el tiempo de cocción manual. Continúe tocándolo si necesita aumentar más minutos.

## OPERACIÓN MANUAL

### Cocción de Alta Potencia

**1** Oprima los botones numéricos para determinar el tiempo de cocción. (Ej: 1 min. 30 seg.)

**2** Toque el botón **START/MINUTE PLUS**.

### Cocción de Potencia Variable

**1** Después de realizar la operación 1 des-crita arriba, toque el botón **POWER LEVEL** seis veces para 50% .

**2** Toque el botón **START/MINUTE PLUS**.

## DESCONGELACIÓN DEFROST

**1** Por ejemplo, toque el botón que dice **STEAKS/CHOPS** cuatro veces para preparar 2.0 lb. Cierre la puerta. Toque el botón **START/MINUTE PLUS**.

El horno se apagará y mostrará las instrucciones a seguir. Siga el mensaje que se le indique.

**2** Después de realizar el paso 1, abra la puerta. Voltee el filete de carne y cubra cualquier porción que esté caliente. Cierre la puerta. Toque el botón **START/MINUTE PLUS**.

**3** Después de realizar el paso 2, abra la puerta. Cubra cualquier porción que esté caliente. Cierre la puerta. Toque el botón **START/MINUTE PLUS**.

**4** Cuando termine el ciclo de descongelar, cúbralo y déjelo reposar.

ALIMENTO	CANTIDAD
Carne molida	.5 a 2.0 libras
Bistec/Chuleta	.5 a 3.0 libras
Pollo sin hueso	.5 a 2.0 libras
Pollo con hueso	.5 a 3.0 libras

## KEEP WARM PLUS

**1** Toque el botón **KEEP WARM PLUS**.

**2** Determine el tiempo deseado en alto 30 min. (Ej.: 15 min.)

**3** Toque el botón **START/MINUTE PLUS**.

# AUTO-TOUCH GUIDE

For more complete information and safety precautions, refer to your Operation Manual.

## SET CLOCK

If **ENJOY YOUR OVEN PRESS CLEAR AND PRESS CLOCK** is in the display, first touch **STOP/CLEAR**.

**1** Touch **TIMER/CLOCK** pad and number **2**.

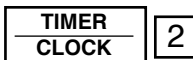

**2** Enter correct time of the day by touching numbers in sequence. (Ex: 12:30)

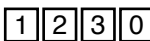

**3** Touch **TIMER/CLOCK** pad again.



## SENSOR REHEAT

Touch **SENSOR REHEAT** pad. The oven will start automatically.



When the sensor detects vapor emitted from the food, the remainder of cooking time will appear.

## SENSOR COOK CHART

FOOD	AMOUNT
SENSOR REHEAT	4 - 36 oz
BAKED POTATOES	1 - 8 med.
POPCORN	1.5 - 3.5 oz bag
FRESH VEGETABLES:	
Soft	.25 - 2.0 lb
Hard	.25 - 1.5 lb
GROUND MEAT	.25 - 2.0 lb
RICE	.5 - 2.0 cups
FISH & SEAFOOD	.25 - 2.0 lb
FROZEN ENTREES	6 - 17 oz
CHICKEN BREAST	.5 - 2.0 lb
FROZEN VEGETABLES	.25 - 1.5 lb

## REHEAT

REHEAT allows you to heat many of your favorite foods.

FOOD	AMOUNT
FRESH ROLLS / MUFFINS	1 - 10
BEVERAGE	.5 - 2.0 cups
FROZEN ROLLS / MUFFINS	1 - 10

## MINUTE PLUS

Touch **MINUTE PLUS** for one minute at 100% power or to add a minute during manual cooking. Continue to touch for additional minutes.



## MANUAL OPERATION

### High Power Cooking

**1** Enter cooking time by touching number pads. (Ex: 1 min. 30 sec.)

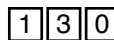

**2** Touch **START/MINUTE PLUS** pad.



### Variable Power Cooking

**1** After step 1 above, touch **POWER LEVEL** pad six times for 50%.



**2** Touch **START/MINUTE PLUS** pad.



## DEFROST

**1** For example, touch **STEAKS/CHOPS** pad 4 times for 2.0 lb. The oven will start automatically.



The oven will stop and directions will be displayed. Follow the indicated message.

x 4

**2** After the 1st stage, open the door. Turn steak over and shield any warm portions. Close the door.



Touch **START/MINUTE PLUS** pad.

**3** After the 2nd stage, open the door. Shield any warm portions. Close the door. Touch **START/MINUTE PLUS** pad.



**4** After the defrost cycle ends, cover food and let stand.

FOOD	AMOUNT
GROUND MEAT	.5 - 2.0 lb
STEAKS/CHOPS	.5 - 3.0 lb
BONELESS POULTRY	.5 - 2.0 lb
BONE-IN POULTRY	.5 - 3.0 lb

## KEEP WARM PLUS

**1** Touch **KEEP WARM PLUS** pad.



**2** Enter the desired time up to 30 minutes. (Ex: 15 minutes)

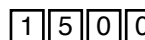

**3** Touch **START/MINUTE PLUS** pad.



Carousel® is a registered trademark of Sharp Corporation.