



**1000 WATTS-LIGHT DUTY  
COMMERCIAL MICROWAVE OVEN**

**MODELS R-21LC, R-21LT, R-21LV  
OPERATION MANUAL**

**FOR CUSTOMER ASSISTANCE**

To aid in reporting this commercial microwave oven in case of loss or theft, please record below the model number and serial number located on the unit. We also suggest you record all the information listed and retain for future reference.

MODEL NUMBER _____	SERIAL NUMBER _____
DATE OF PURCHASE _____	
DEALER _____	TELEPHONE _____
SERVICER _____	TELEPHONE _____

**TO PHONE:**

SERVICE and PARTS  
(for your nearest Sharp Authorized Servicer and Parts Distributor)  
United States ..... 1-800-BE-SHARP(237-4277)

ADDITIONAL  
CUSTOMER INFORMATION ..... 201-529-8711

**TO WRITE:**

For additional information:

Commercial Microwave Oven Department  
Sharp Electronics Corporation  
Sharp Plaza, Box 650  
Mahwah, NJ 07430-2135

For service problems, warranty information, missing items and other assistance:

Sharp Electronics Corporation  
Customer Assistance Center  
1300 Naperville Drive  
Romeoville, IL 60446-1091

Please provide the following information when you write or call: model number, serial number, date of purchase, your complete mailing address (including zip code), your daytime telephone number (including area code) and description of the problem.

**TO ACCESS INTERNET:**

WWW.sharppusa.com

# CONTENTS

For Customer Assistance .....	Front cover	
Contents .....	1	
Precautions to Avoid Possible Exposure to Excessive Microwave Energy .....	1	
Limited Warranty .....	2	
Important Safety Instructions .....	3	
Grounding Instructions .....	4	
Installation .....	4	
Part Names .....	5	
Steps for Operating for R-21LC .....	7	
Defrosting Frozen Foods Chart .....	7	
Steps for Operating for R-21LT/LV .....	8	
Before Operation .....	8	
Memory Operation .....	8	
Cooking with memory .....	8	
Cooking double quantity with memory .....	8	
Memory program entry .....	9	
Setting time and power level .....	9	
Setting magnification factor .....	9	
Memory check .....	10	
Checking time and power level .....	10	
Checking magnification .....	10	
Manual Operations .....	11	
Time cooking .....	11	
Multiple sequence cooking .....	11	
Express Defrost .....	12	
Express Defrost Chart .....	12	
Counter check .....	13	
To check times used .....	13	
To clear the number of times .....	13	
Other Convenient Features .....	14	
Signal setting .....	14	
Demonstration Mode .....	14	
Service Call Check .....	14	
Care and Cleaning .....	15	
Cooking Guide .....	16	
Utensils .....	16	
Guidelines for microwave heating .....	17	
Timing guide .....	18	
Heating and cooking time guide .....	19	
Reminders .....	21	
Specifications .....	21	
Auto-Touch Guide .....	22-Back cover	

## PRECAUTIONS TO AVOID POSSIBLE EXPOSURE TO EXCESSIVE MICROWAVE ENERGY

- (a) Do not attempt to operate this oven with the door open since open-door operation can result in harmful exposure to microwave energy. It is important not to defeat or tamper with the safety interlocks.
- (b) Do not place any object between the oven front face and the door or allow soil or cleaner residue to accumulate on sealing surfaces.
- (c) Do not operate the oven if it is damaged. It is particularly important that the oven door close properly and that there is no damage to the: (1) door (bent), (2) hinges and latches (broken or loosened), (3) door seals and sealing surfaces.
- (d) The oven should not be adjusted or repaired by anyone except properly qualified service personnel.

# LIMITED WARRANTY

## END-USER LIMITED WARRANTY

SHARP ELECTRONICS CORPORATION warrants to the first end-user purchaser that this Sharp brand product (the "Product"), when shipped in its original container, will be free from defective workmanship and materials, and agrees that it will, at its option, either repair the defect or replace the defective Product or part there of with a new or remanufactured equivalent at no charge to the purchaser for parts or labor for the period(s) set forth below.

This warranty does not apply to any appearance items of the Product nor to the additional excluded item(s) set forth below nor to any Product the exterior of which has been damaged or defaced, which has been subjected to improper voltage or other misuse, abnormal service or handling, or which has been altered or modified in design or construction.

In order to enforce the rights under this limited warranty, the purchaser should follow the steps set forth below and provide proof of purchase to the servicer.

To the extent permitted by applicable state law, the warranties set forth herein are in lieu of, and exclusive of, all other warranties, express or implied. Specifically, ALL OTHER WARRANTIES OTHER THAN THOSE SET FORTH ABOVE ARE EXCLUDED. ALL EXPRESS AND IMPLIED WARRANTIES INCLUDING THE WARRANTIES OF MERCHANTABILITY, FITNESS FOR USE, AND FITNESS FOR A PARTICULAR PURPOSE ARE SPECIFICALLY EXCLUDED. If, under applicable state law, implied warranties may not validly be disclaimed or excluded, the duration of such implied warranties is limited to the period(s) from the date of purchase set forth below.

Neither the sales personnel of the seller nor any other person is authorized to make any warranties other than those described herein, or to extend the duration of any warranties beyond the time period described herein on behalf of Sharp.

The warranties described above shall be the sole and exclusive warranties granted by Sharp and shall be the sole and exclusive remedy available to the purchaser. Correction of defects, in the manner and for the period of time described herein, shall constitute complete fulfillment of all liabilities and responsibilities of Sharp to the purchaser with respect to the Product, and shall constitute full satisfaction of all claims, whether based on contract, negligence, strict liability or otherwise. In no event shall Sharp be liable, or in any way responsible, for any damages or defects in the Product which were caused by repairs or attempted repairs performed by anyone other than an authorized servicer. Nor shall Sharp be liable or in any way responsible for any incidental or consequential economic or property damage. Some states do not allow limits on warranties or on remedies for breach in certain transactions; in such states, the limits herein may not apply.

Your Product Model Number & Description:

R-21LC, R-21LT or R-21LV  
Commercial Microwave Oven  
(Be sure to have this information available when you need service for your oven.)

Warranty Period for this Product:

R-21LT: Three (3) years for parts and labor in the end user's place of business

R-21LC or R-21LV: One (1) year for parts and labor in the end user's place of business. The warranty continues for an additional two years, for a total of three years, with respect to the magnetron tube; labor and service are not provided free of charge for this additional period.

Additional Item(s) Excluded from Warranty Coverage (if any):

Non-functional accessories and light bulb.

Where to Obtain Service:

Contract your Sharp Authorized Servicer to obtain on-site service for this Product. The Servicer will come to your location and if it is necessary to remove the Product, the Servicer will reinstall it. Be sure to have Proof of Purchase available.

TO OBTAIN SUPPLY OR PRODUCT INFORMATION, CALL 1-800-BE-SHARP OR VISIT [www.sharpsusa.com](http://www.sharpsusa.com). Save the proof of purchase as it is needed should your oven ever require warranty service.

# IMPORTANT SAFETY INSTRUCTIONS

When using electrical appliances basic safety precautions should be followed, including the following:

**WARNING** - To reduce the risk of burns, electric shock, fire, injury to persons or exposure to excessive microwave energy:

1. Read all instructions before using the appliance.
2. Read and follow the specific "PRECAUTIONS TO AVOID POSSIBLE EXPOSURE TO EXCESSIVE MICROWAVE ENERGY" on page 1.
3. This appliance must be grounded. Connect only to properly grounded outlet.  
See "GROUNDING INSTRUCTIONS" on page 4.
4. Install or locate this appliance only in accordance with the provided installation instructions.
5. Some products such as whole eggs and sealed containers – for example, closed glass jars – are able to explode and should not be heated in this oven.
6. Use this appliance only for its intended use as described in this manual. Do not use corrosive chemicals or vapors in this appliance. This type of oven is specifically designed to heat, cook or dry food. It is not designed for industrial or laboratory use.
7. As with any appliance, close supervision is necessary when used by children.
8. Do not operate this appliance if it has a damaged cord or plug, if it is not working properly or if it has been damaged or dropped.
9. This appliance should be serviced only by qualified service personnel. Contact nearest Sharp Authorized Servicer for examination, repair or adjustment.
10. Do not cover or block any openings on the appliance.
11. Do not store or use this appliance outdoors. Do not use this product near water – for example, near a kitchen sink, in a wet basement, near a swimming pool or similar locations.
12. Do not use this appliance near the steamer or the fryer.
13. Do not immerse cord or plug in water.
14. Keep cord away from heated surfaces.
15. Do not let cord hang over edge of table or counter.
16. See door surface cleaning instructions on page 15.
17. To reduce the risk of fire in the oven cavity:
  - a. Do not overcook food. Carefully attend appliance when paper, plastic or other combustible materials are placed inside the oven to facilitate cooking.
  - b. Remove wire twist-ties from paper or plastic bags before placing bag in oven.
  - c. If materials inside the oven ignite, keep oven door closed, turn oven off and disconnect the power cord or shut off power at the fuse or circuit breaker panel.
  - d. Do not use the cavity for storage purposes. Do not leave paper products, cooking utensils or food in the cavity when not in use.
18. Liquids, such as water, coffee, or tea are able to be overheated beyond the boiling point without appearing to be boiling. Visible bubbling or boiling when the container is removed from the microwave oven is not always present. **THIS COULD RESULT IN VERY HOT LIQUIDS SUDDENLY BOILING OVER WHEN A SPOON OR OTHER UTENSIL IS INSERTED INTO THE LIQUID.**  
To reduce the risk of injury to persons:
  - a. Do not overheat the liquid.
  - b. Stir the liquid both before and halfway through heating it.
  - c. Do not use straight-sided containers with narrow necks. Use a wide-mouthed container.
  - d. After heating, allow the container to stand in the microwave oven at least for 20 seconds before removing the container.
  - e. Use extreme care when inserting a spoon or other utensil into the container.
19. If the oven light fails, consult a SHARP AUTHORIZED SERVICER.

## SAVE THESE INSTRUCTIONS

# GROUNDING INSTRUCTIONS

This appliance must be grounded. This oven is equipped with a cord having a grounding wire with a grounding plug. It must be plugged into a wall receptacle that is properly installed and grounded in accordance with the National Electrical Code and local codes and ordinances. In the event of an electrical short circuit, grounding reduces risk of electric shock by providing an escape wire for the electric current.

**WARNING** – Improper use of the grounding plug can result in a risk of electric shock.

## Electrical Requirements

The electrical requirements are a 120 volt 60 Hz, AC only, 15 amp. or more protected electrical supply. It is recommended that a separate circuit serving only this appliance be provided.

The oven is equipped with a 3-prong grounding plug. It must be plugged into a wall receptacle that is properly installed and grounded. Should you only have a 2-prong outlet, have a qualified electrician install a correct wall receptacle.

A 3-prong adapter may be purchased and used temporarily if local codes allow. Follow package directions.

A short power-supply cord is provided to reduce risk of becoming entangled in or tripping over a longer cord.

## Extension Cord

If it is necessary to use an extension cord, use only a 3-wire extension cord that has a 3-blade grounding plug and a 3-slot receptacle that will accept the plug on the microwave oven. The marked rating of the extension cord should be AC 115-120 volt, 15 amp. or more.

Be careful not to drape the cord over the countertop or table where it can be pulled on by children or tripped over accidentally.

- Notes:**
1. If you have any questions about the grounding or electrical instructions, consult a qualified electrician or service person.
  2. Neither Sharp nor the dealer can accept any liability for damage to the oven or personal injury resulting from failure to observe the correct electrical connection procedures.

## Radio or TV Interference

Should there be any interference caused by the microwave oven to your radio or TV, check that the microwave oven is on a different electrical circuit, relocate the radio or TV as far away from the oven as feasible or check position and signal of receiving antenna.

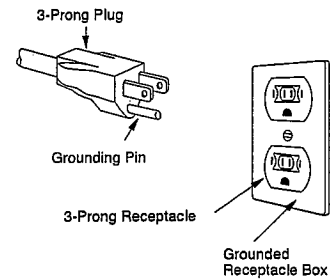

Permanent and Correct Installation

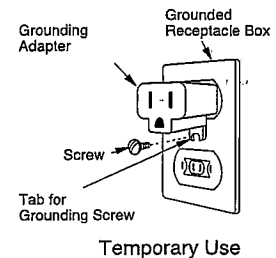

Temporary Use

# INSTALLATION

Because your Sharp Commercial Microwave Oven will be used frequently, place it so that there is easy access for all users.

1. Be sure all electrical requirements are met. See above.
2. Air intake openings are on the back of the unit. Install the unit at least 2 inches (5.1 cm) away from the nearest wall to permit adequate ventilation for proper cooling and air flow in the oven.
3. Install the unit where no excessive heat or steam are generated. Do not place next to an oven or cooking surface.
4. The unit may be secured to a countertop or stand. There is a screw hole in the bottom of the unit. After the oven is permanently placed, drill a hole through the counter top for a 3/16 inch (0.48 cm) self-tapping screw. The hole should be 1 inch (2.5 cm) from the left side of the outer case cabinet and 7-1/8 inches back from the front edge of the cavity face plate.

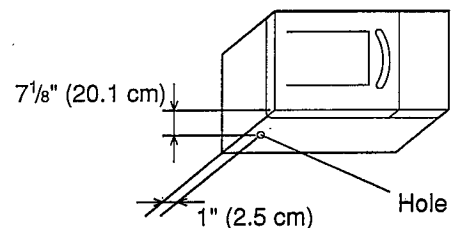

# PART NAMES

## MICROWAVE OVEN PARTS

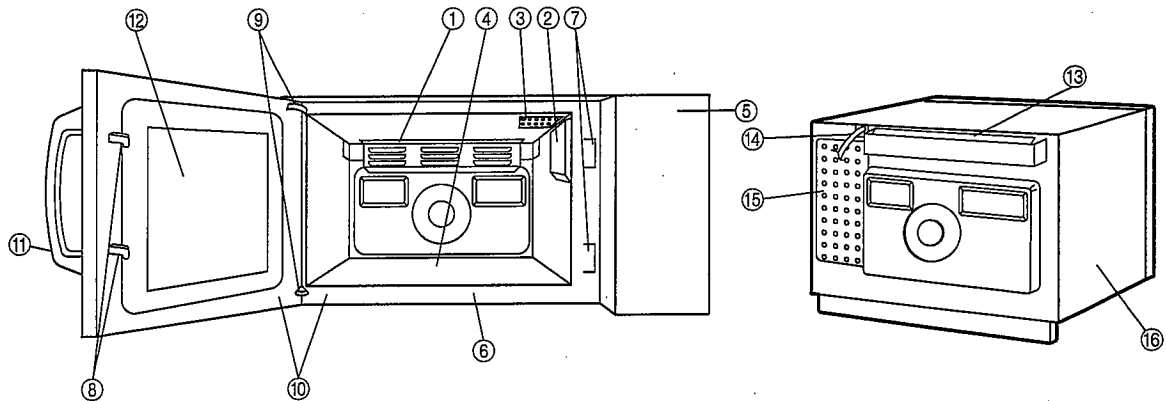

1. Back splash cover
2. Side splash cover
3. Oven light
4. Ceramic shelf
5. Control panel
6. Cavity face plate
7. Door latch openings
8. Door latches

9. Door hinges
10. Door seals and sealing surfaces
11. Door handle
12. Oven door with see-through window
13. Air ventilation cover and openings
14. Power supply cord
15. Air intake openings
16. Outer case cabinet

# PART NAMES

## CONTROL PANEL

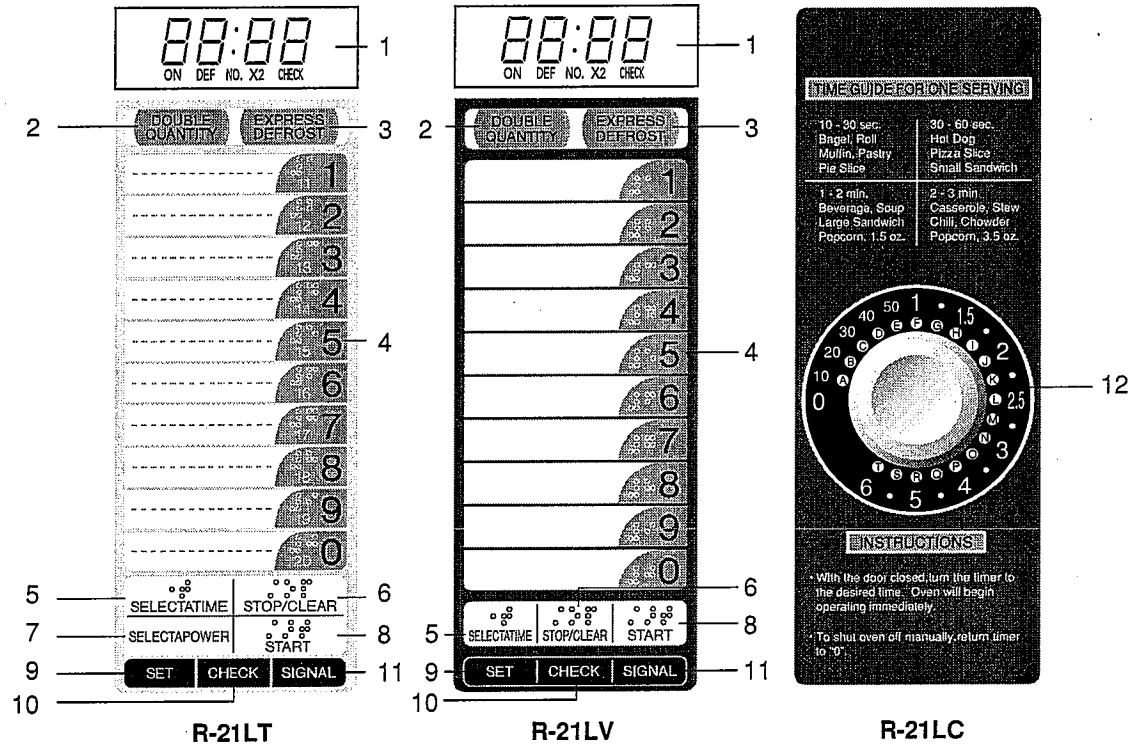

1. Digital readout
2. DOUBLE QUANTITY pad
3. EXPRESS DEFROST pad
4. Ten number pads for time and memory programming
5. SELECT TIME pad
6. STOP/CLEAR pad; touch to stop operation of oven and clear remaining heating time
7. SELECT POWER pad for setting variable power level (R-21LT only)
8. START pad; touch to operate oven after door is closed and time is set
9. SET pad for setting memory
10. CHECK pad for checking memory
11. SIGNAL pad for setting signal sound

12. Light Up Dial for setting cooking time (R-21LC only)  
The letters from A to T correspond to cooking time for convenience.

# STEPS FOR OPERATING FOR R-21LC

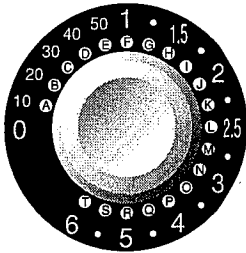

Your oven can be programmed for up to 6 minutes on HIGH (100%) power. The cooking time input varies from 10 seconds to 30 seconds depending on the total length of the cooking time as shown in the table below.

Cooking time	Increment
0 - 1 minute	10 seconds
1 - 3 minutes	15 seconds
3 - 6 minutes	30 seconds

1. Place food on the ceramic shelf and close the door securely.
2. Turn the Light Up Dial to the desired cooking time. Note that the light indicates the cooking time. Cooking will start immediately.
3. The oven light and the cooling fan will be on throughout any cooking operation.
4. When the Light Up Dial reaches "0" and the audible signal is heard, oven operation ceases, the light goes out and the fan stops.

**NOTE:**

- The Light Up Dial can be set to operate the oven within 1 minute after a cooking cycle ends or after closing the door.
- When the oven door is opened during cooking, the oven stops and any remaining cooking time is canceled. If necessary, turn the Light Up Dial to the desired cooking time again.

## DEFROSTING FROZEN FOODS CHART

Item	Weight	Microwave Time	Procedure
<b>Ground Meat</b>	.50 lb. (225 g)	1 minute	1. Power on 30 seconds. Break apart and remove defrosted pieces. Stand 1 minute. 2. Power on 30 seconds. Allow to stand for 5 minutes to equalize temperatures.
	1.00 lb. (450 g)	2 minutes	1. Power on 1 minute. Break apart and remove defrosted pieces. Stand 2 minutes. 2. Power on 1 minute. Allow to stand for 5 minutes to equalize temperatures.
<b>Steaks</b> 3/4" (1.9 cm)	1.00 lb. (450 g)	2 minutes	1. Power on 1 minute. Separate and shield, if necessary. Stand 1 minute. 2. Power on 1 minute. Allow to stand for 5 minutes to equalize temperatures.
	1.50 lb. (675 g)	3 minutes	1. Power on 1 1/2 minutes. Separate and shield, if necessary. Stand 2 minutes. 2. Power on 1 1/2 minutes. Allow to stand for 5 minutes to equalize temperatures.
<b>Chops</b>	1.00 lb. (450 g)	1 1/2 minutes	1. Power on 45 seconds. Separate and shield, if necessary. Stand 2 minutes. 2. Power on 45 seconds. Allow to stand for 5 minutes to equalize temperatures.
<b>Boneless Chicken Breasts</b>	1.00 lb. (450 g)	1 1/2 minutes	1. Power on 45 seconds. Separate and shield, if necessary. Stand 2 minutes. 2. Turn chicken over and rearrange. Power on 45 seconds. Allow to stand for 3 minutes to equalize temperatures.
<b>Chicken Pieces (with bone)</b>	1.00 lb. (450 g)	2 minutes	1. Power on 1 minute. Separate and shield, if necessary. Stand 2 minutes. 2. Turn chicken over and rearrange. Power on 1 minute. Allow to stand for 3 minutes to equalize temperatures.
	2.00 lb. (900 g)	3 minutes	1. Power on 1 1/2 minutes. Separate and shield, if necessary. Stand 2 minutes. 2. Turn chicken over and rearrange. Power on 1 1/2 minutes. Allow to stand for 3 minutes to equalize temperatures.



# STEPS FOR OPERATING FOR R-21LT, R-21LV

## BEFORE OPERATION

\* Before operating your new oven, make sure you read and understand this operation manual completely.

- 1) Plug in the oven.  
The digital display will then show   .
- 2) You can input the pads only when the door is closed.
- 3) Oven light will come on when the oven is operating or the door is open.

- 4) The program and the check are canceled when any pads are not touched for more than 3 minutes.
- 5) During cooking, except memory cooking, the oven stops when the door is opened, and the program is canceled if the START pad is not touched within 1 minute after the door is closed.
- 6) The cooking is canceled when the door is opened during memory cooking.

## MEMORY OPERATION

The R-21LT model has 20 and R-21LV has 10 memory banks which can store cooking programs. The first ten memory banks have been programmed previously as follows, but they can be changed. See page 9.

Memory No.	Cook Time	Output Power
1	10 sec.	100%
2	20 sec.	100%
3	30 sec.	100%
4	45 sec.	100%
5	1 min.	100%
6	1 min. 15 sec.	100%
7	1 min. 30 sec.	100%
8	2 min.	100%
9	2 min. 30 sec.	100%
0	3 min.	100%

Information in these memory banks is not lost due to power interruptions. If the power goes off, the oven does not need to be reprogrammed. No batteries are necessary for this type of memory.

## Cooking with memory

\* Suppose you want to cook by using memory 1, which was programmed for 10 seconds at 100%.

Procedure	Display
1 Place food in oven. Touch number pad.	<span style="border: 1px solid black; padding: 2px;">1</span> NO. 1
	After about 1 sec. <span style="border: 1px solid black; padding: 2px;">ON . 10</span>

## Cooking double quantity with memory

Double quantity means the best time for cooking two servings or twice the amount programmed in the memory pad; it is not double the time.

\* Suppose you want to cook 2 servings by memory number 1.

Procedure	Display
<span style="border: 1px solid black; padding: 2px;">DOUBLE QUANTITY</span> 1 Place food in oven. Touch DOUBLE QUANTITY pad.	<span style="border: 1px solid black; padding: 2px;">NO. X2</span>
<span style="border: 1px solid black; padding: 2px;">1</span> 2 Touch number pad.	<span style="border: 1px solid black; padding: 2px;">NO. X2 1</span>
	After about 1 sec. <span style="border: 1px solid black; padding: 2px;">ON . 17</span>

Note: The "MEMORY" cooking system does not require the use of the START pad. Memory pad cannot be used to start the oven if any program is on display.

If the door is opened during memory cooking, the program is canceled. To stop the cooking of a memory pad and then restart, first, touch the STOP/CLEAR pad, then open the door, check food, close door and touch START.

If your programmed time is over maximum time at Double Quantity, you cannot use Double Quantity for the memory. You can cook only 1 serving. See page 11.

Note: (For R-21LT)

If you want to cook by using memory 11-20, touch the desired number pad twice within 1 second.

## Memory program entry

You can change memory programs for memory banks. See time cooking on page 11.

### R-21LT

<b>Memory banks</b>	20
<b>Cooking stage</b>	
Memory NO.1 -10	max. 3 stages
Memory NO. 11-20	max. 2 stages





### R-21LV

<b>Memory banks</b>	10
<b>Cooking stage</b>	1 stage

The R-21LV can be programmed only using 100% power. Follow steps 1,2,3 and 7 below.

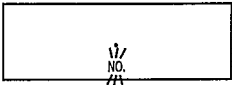
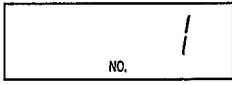
## Setting time and power level

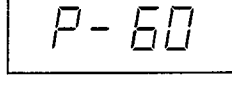
\* Suppose you want to set 4 minutes at 60% for the 1st stage and 2 minutes at 30% for the 2nd stage for 1 serving in memory 1.(R-21LT)

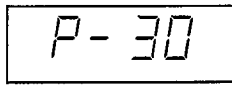
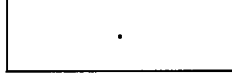
Procedure	Display
<p><b>SET</b> x 2</p> <p>1 Touch SET pad twice within 2 sec.</p>	
<p><b>1</b></p> <p>2 Touch number pad.</p>	
<p><b>SELECTATIME</b></p> <p><b>4 0 0</b></p> <p>3 Enter cooking time for 1st stage.</p>	
<p><b>SELECTAPOWER</b> <b>6</b></p> <p>4 Enter power level in 1st stage.</p>	
<p><b>SELECTATIME</b></p> <p><b>2 0 0</b></p> <p>5 Enter cooking time for 2nd stage.</p>	
<p><b>SELECTAPOWER</b> <b>3</b></p> <p>6 Enter power level for 2nd stage.</p>	
<p><b>SET</b> x 2</p> <p>7 Touch SET pad twice.</p>	

Note: 1. (For R-21LT)

If you want to set memory 11-20, press the desired number pad twice.

2. If the cooking time is over the maximum time, the display will show "EE 9". See page 11.

3. At step 1, no audible signal will be heard when the SET pad is touched the first time. An audible signal will sound when the SET pad is touched the second time.

## Setting magnification factor

Ovens are shipped with a magnification factor of 1.7 for DOUBLE QUANTITY.

You can change the magnification factor for double quantity and have it stored in the memory.

\* Suppose you want to set the magnification factor to 1.67 for double quantity in memory 1.

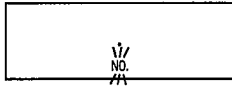
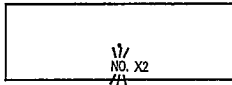
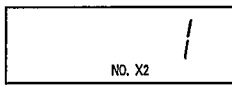
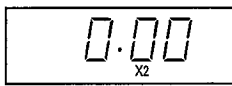
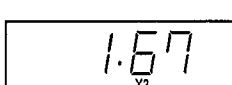
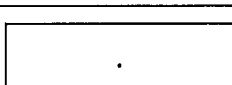
Procedure	Display
<p><b>SET</b> x 2</p> <p>1 Touch SET pad twice within 2 sec.</p>	
<p><b>DOUBLE QUANTITY</b></p> <p>2 Touch DOUBLE QUANTITY pad.</p>	
<p><b>1</b></p> <p>3 Touch number pad 1.</p>	
<p><b>SELECTATIME</b></p> <p>4 Touch SELECTATIME pad.</p>	
<p><b>1 6 7</b></p> <p>5 Touch NUMBER pads 1,6 and 7.</p>	
<p><b>SET</b> x 2</p> <p>6 Touch SET pad twice.</p>	

Note: 1. In case you want to change the magnification factor it must be set for each pad separately.

2. The magnification factor can be set from 0.00 to 9.99.

3. At step 1, no audible signal will be heard when the SET pad is touched the first time. An audible signal will sound when the SET pad is touched the second time.

## Memory check

You can check the information programmed into each memory.

### Checking time and power level

\* Suppose you want to know the information programmed into memory 1, programmed for 4 minutes at 60% for the 1st stage and 2 minutes at 30% at the 2nd stage.

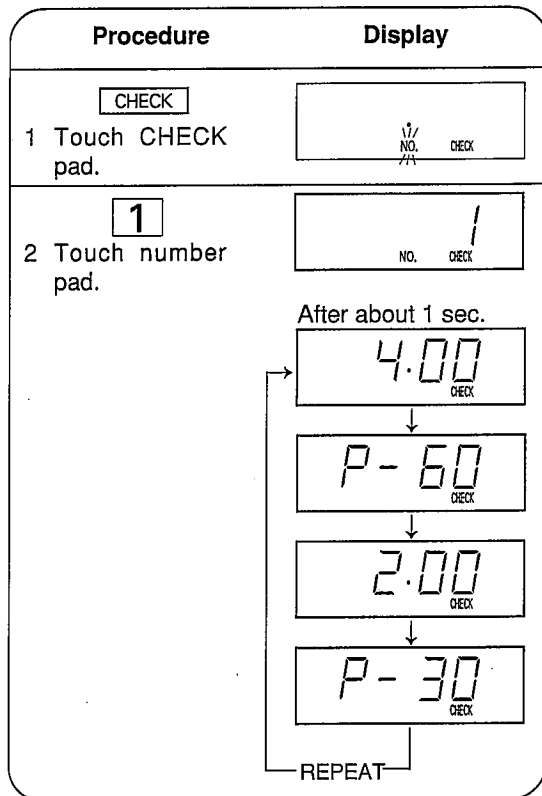

- Note: 1. To cancel memory check, touch the CHECK pad.
2. When is displayed at Step 1, the memory is not set.
3. (For R-21LT)  
If you want to check memory 11-20, touch the desired number pad twice within 1 second.

## Checking magnification

\* Suppose you want to know the magnification factor for double quantity in memory 1.

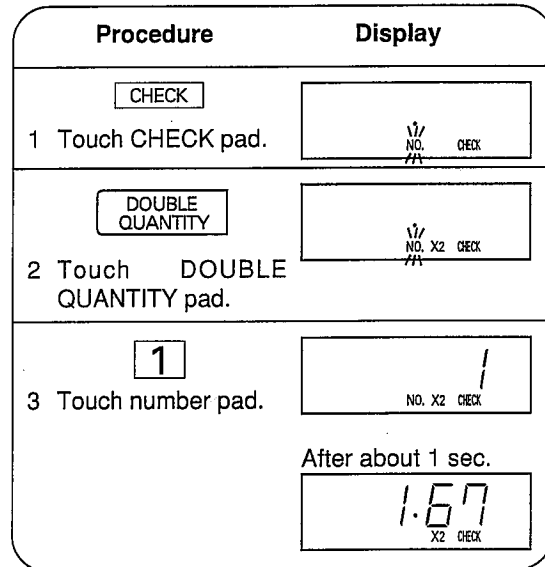

- Note: 1. To cancel memory check, touch the CHECK pad.
2. The magnification factor 1.7 for the DOUBLE QUANTITY is stored in all memories when the oven is shipped.

# MANUAL OPERATIONS

## Time cooking

### R-21LT

Your oven can be programmed for up to 3 cooking sequences and has 11 preset microwave power levels.

<b>Cooking sequence</b>	Max.3 stages
<b>Microwave power level</b>	0~100%
<b>Cooking time</b>	Max. 30 minutes for each stage. And total cooking time is max.30 minutes.

This model has 11 power levels. Use correct number pad after touching SELECTAPOWVER pad.

Microwave POWER level	Number pads	Display
100%	-	P-41
90%	9	P-90
80%	8	P-80
70%	7	P-70
60%	6	P-60
50%	5	P-50
40%	4	P-40
30%	3	P-30
20%	2	P-20
10%	1	P-10
0%	0	P-0

\* Suppose you want to cook for 2 minutes and 30 seconds at 50%.

Procedure	Display
SELECTATIME 2 3 0 1 Enter cooking time.	2.30
SELECTAPOWVER 5 2 Enter power level. (R-21LT only)	P-50
START 3 Touch START pad.	ON 2.30

Note: It is not necessary to touch SELECTAPOWVER pad for 100%. If the cooking time is over the maximum time, the display will show "EE 9".

### R-21LV

Your oven can be programmed for only one stage on 100% power level with a maximum of 30 minutes. Follow steps 1 and 3.

<b>Cooking sequence</b>	1 stage
<b>Microwave power level</b>	100% only
<b>Cooking time</b>	Max. 30 minutes

## Multiple sequence cooking

(R-21LT only)

\*Suppose you want to cook for 4 minutes at 60 % for 1st stage and then continue to cook for 2 minutes at 30% for 2nd stage.

Procedure	Display
SELECTATIME 4 0 0 1 Enter cooking time in 1st stage.	4.00
SELECTAPOWVER 6 2. Enter power level in 1st stage.	P-60
SELECTATIME 2 0 0 3. Enter cooking time in 2nd stage.	2.00
SELECTAPOWVER 3 4. Enter power level in 2nd stage.	P-30
START 5. Touch START pad.	ON 6.00

## Express Defrost

Use Express Defrost to defrost meat and poultry faster and better. Calculate total defrost time from chart below. Express Defrost can be programmed for a maximum of 90 minutes.

\* Suppose you want to defrost one pound of lamb chops for 2 minutes and 30 seconds.

Procedure	Display
<div style="border: 1px solid black; padding: 2px; display: inline-block; margin-bottom: 5px;">EXPRESS DEFROST</div> 1 Touch EXPRESS DEFROST pad.	<div style="border: 1px solid black; padding: 5px; display: inline-block;">DEF 0</div>
<div style="display: inline-block; border: 1px solid black; padding: 2px; margin-right: 5px;">2</div> <div style="display: inline-block; border: 1px solid black; padding: 2px; margin-right: 5px;">3</div> <div style="display: inline-block; border: 1px solid black; padding: 2px;">0</div> 2 Enter defrosting time. (Refer to chart below.)	<div style="border: 1px solid black; padding: 5px; display: inline-block;">DEF 2.30</div>
<div style="border: 1px solid black; padding: 2px; display: inline-block; margin-bottom: 5px;">START</div> 3 Touch START pad.	<div style="border: 1px solid black; padding: 5px; display: inline-block;">ON DEF 2.30</div>
Midway through the defrosting cycle, CHECK will light in the display and an audible signal will be heard. You may open the door, turn food over and shield any warm portions. Close the door.	
<div style="border: 1px solid black; padding: 2px; display: inline-block; margin-bottom: 5px;">START</div> 4 Touch START pad.	

**Note:** If you do not open the door when an audible signal sounds, the defrosting cycle will continue and the defrosting time will count down to 0.

**TIPS:** Allow foods to stand a few minutes after defrosting to equalize the temperature for better cooking results.

Check food after standing. If additional time is needed, continue to defrost with time cooking. It is better to defrost with 30% power for R-21LT. For R-21LV, it is better to defrost with Express Defrost continuously.

Foods that are the same thickness throughout defrost better. If foods have varied thickness, it may be necessary to shield the thin edges with small flat pieces of aluminum foil to prevent overdefrosting.

## Express Defrost Chart

Food	Thickness	Time (min./lb.*)
Beef steak	less than 1" (2.5 cm)	3-3½
	more than 1" (2.5 cm)	3½-4
Lamb chops	1" (2.5 cm)	2½-3
Pork chops	less than 1" (2.5 cm)	2½-3
	more than 1" (2.5 cm)	3½-4
Boneless chicken breasts	½"-¾" (1.3-1.9 cm)	2½-3
	¾"-1" (1.9-2.5 cm)	3-3½
Fish steak	½"-¾" (1.3-1.9 cm)	2-2½
	¾"-1" (1.9-2.5 cm)	2½-3

\*1 lb. = 450 g

## Counter check

Set counter to "0" before using oven for the first time. See next column.

### To check times used

You can check total times oven, each memory, manual cooking and Express Defrost were used.

**Total count** Touch CHECK pad twice.

To check count, touch each pad as indicated below, after touching CHECK pad twice.

**Count of memory** Touch each number pad of memory.

**Count of manual cooking** Touch SELECTATIME pad.

**Count of Express Defrost** Touch EXPRESS DEFROST pad.

\* Suppose you want to know total times oven and memory pad 1 were used. In that case the oven was used 8268 times and the memory 1 was used 513 times.

Procedure	Display
<p><b>CHECK</b> x 2</p> <p>1 Touch CHECK pad 2 times. Total count will be displayed.</p>	
<p><b>1</b></p> <p>2 Touch number pad 1 to check total times it was used.</p>	<p>NO. </p> <p>After about 1 sec.</p>

- Note: 1. To cancel counter check, touch CHECK pad.  
 2. (FOR R-21LT)  
 You can know count of memory pads 1 - 10 only. Memory pads 11 - 20 cannot be checked.  
 3. When the maximum count of 9999 is reached, it will return to 0.

## To clear the number of times

Each number of times can be cleared by touching SET pad during checking mode.

\* Suppose you want to clear the times of memory 1.

Procedure	Display
<p><b>CHECK</b> x 2</p> <p>1 Touch CHECK pad 2 times. Total count will be displayed.</p>	
<p><b>1</b></p> <p>2 Touch number pad 1 to check total times it was used.*</p>	<p>NO. </p> <p>After about 1 sec.</p>
<p><b>SET</b></p> <p>3 Touch SET pad.</p>	

- Note: 1. To cancel counter check, touch CHECK pad.  
 2. To clear times of manual cooking, touch SELECTATIME pad in Step 2 instead of number pad.  
 3. To clear times of Express Defrost, touch EXPRESS DEFROST pad in Step 2 instead of number pad.  
 4. To clear total times used, skip Step 2.

## OTHER CONVENIENT FEATURES

### Signal setting

There is a choice of 2 different sounds and no sound on your oven.

To set signal, touch the SET pad twice within 2 seconds and then touch the SIGNAL pad continuously until you hear desired tone.

### Demonstration mode

To demonstrate, touch SELECTATIME, 0 and then touch START and hold for 3 seconds. Cooking operations can now be demonstrated with no power in the oven. The timer will count down rapidly.

To cancel, touch SELECTATIME, then 0 and STOP/CLEAR.

## SERVICE CALL CHECK

Please check the following before calling for service!

1. Plug the power cord into a three-pronged electric-outlet. (See page 4)
2. Place one cup of water in a glass measure in the oven and close the door securely.

Operate the oven for one minute on High (100%).

- |   |                    |
|---|--------------------|
| A. Does the oven light come on?   | Yes _____ No _____ |
| B. Does the cooling fan work?<br>(Put your hand over the back ventilation opening.) | Yes _____ No _____ |
| C. (For R-21LT or R-21LV) Does the "ON" indicator come on?                          | Yes _____ No _____ |
| D. At the end of 1 minute, is the water hot?  | Yes _____ No _____ |

If "NO" is the answer to any of the above questions, please check electrical outlet, fuse and/or circuit breaker. If they are functioning properly, CONTACT YOUR NEAREST SHARP AUTHORIZED SERVICER. A microwave oven should never be serviced by a "do-it-yourself" repair person.

**NOTE:** If time is counting down very rapidly, the demonstration mode may be set. To cancel, unplug the oven from the electrical outlet and replug.

### ERROR MODE

Should the error indicator appear in the readout, follow the instructions:

EE Mode	Reason	Action Required
EE 9	Maximum time is exceeded	Check page 11 in the Operation Manual. Touch STOP/CLEAR pad and reprogram correctly.

# CARE AND CLEANING

## VERY IMPORTANT CAUTIONS

- \*DO NOT OPERATE the oven without the splash covers in place.
- \*DO NOT REMOVE the ceramic shelf from the oven.
- \*DO NOT OPERATE the oven without the air ventilation cover.
- \*DO NOT USE commercial oven cleaners, abrasive or harsh cleaners or scouring pads on any part of your microwave oven.

### Oven exterior

The outside of your oven can be easily cleaned with mild soap and water. Make sure to rinse thoroughly and dry the exterior with a soft towel.

### Control panel

Care should be taken in cleaning the control panel. Open the door before cleaning to inactivate the control panel pads.

Using a cloth dampened with water only, gently wipe the panel until it becomes clean. Avoid the use of excess water. Do not use any sort of chemical or abrasive cleaner. To do so may cause severe damage to the panel and make programming impossible.

### Caution for R-21LC:

Take care not to move the Light Up Dial from "0" during cleaning, or the oven will start as soon as you close the door.

### Oven interior

- 1) For easy cleaning, wipe any spatters or spills with a soft damp cloth or sponge at the end of each day. For heavier spills, use mild soap and rinse thoroughly with hot water.
- 2) At least once a week, remove the splash covers and wash in a mild detergent solution. The splash covers are located on the back wall near the top of the oven and on the right side wall. The covers may be removed easily. Simply remove four clips (A) as shown in Fig. 1. Then remove the splash covers from the oven.

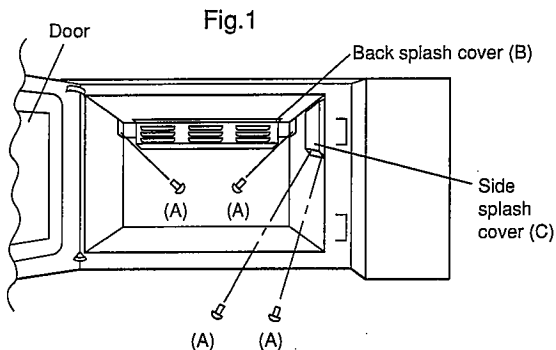

To replace the back splash cover (B), secure the cover to the oven side walls with two clips (A) as shown in Fig. 1.

To replace the side splash cover (C), insert two projections of the cover (C) into the holes of the oven right wall as shown in Fig 2. And secure the cover to the oven right wall with two clips (A) as shown in Fig 1.

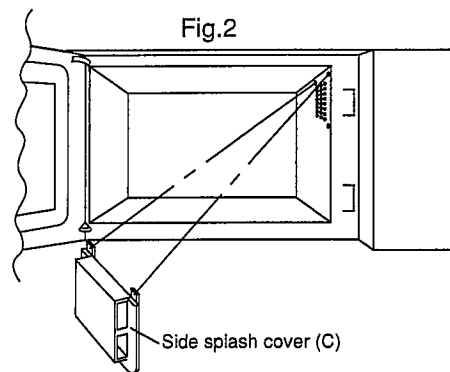

- 3) Wipe any grease, spills or spatters on the door seal surfaces with a soft damp cloth or sponge so that they do not build up. The door seals must always be free of grease and spatters so that the door closes properly.

### Door

Wipe the door and window on both sides frequently with a damp cloth to remove any spills or spatters. Always keep the door seals and seal surfaces clean so that any grease, spills or spatters are not allowed to build up. Such a build-up could result in leakage of microwave energy from the oven.



# COOKING GUIDE

## Utensils

### METAL

#### 1) Frozen Precooked Foods in Foil Containers

When cooking foods in foil containers, the container should be no more than 1/2" (1.3 cm) deep. The best method to use is, after removing the foil cover, return the metal container to the paper box or package it came in and place this entire unit in the microwave oven. There must be more food than metal, and the metal container must not touch the oven walls.

#### 2) Metal Skewers

Small metal skewers may be used if there is a large proportion of food to the amount of metal. If arcing does begin, stop the oven, remove the food and change to a wooden skewer.

Whenever using metal foil, foil containers or metal skewers, be sure that the metal does not touch the sides of the oven.

### GLASS, GLASS-CERAMIC, CERAMIC AND CHINA UTENSILS

Most glass, glass ceramic, ceramic and china utensils are excellent for use in microwave ovens. Heat-resistant glassware, unless it has metallic trim or metal portions, can almost always be used in the microwave oven, no matter whether it is clear or opaque. However, you must be careful not to use delicate glassware since it might crack from the heat of the food but not from the microwaves.

Most dinner plates, unless they have metallic trim, are acceptable for heating foods.

Utensils with metallic trim or metal parts, such as screws, bands, handles, etc. must be avoided. Cracked or crazed glazes or chips are also indications that a dish should not be used. Ceramic mugs or cups with glued on handles are also not recommended for use in a microwave oven.

### PAPER GOODS

For low heat cooking, such as reheating or very short cooking times and for foods with low fat, sugar or water content, paper is a good utensil for microwave oven use. Napkins, towels, plates, cups, cartons, paper freezer wrap and the paper pulp board that some meats come packed in are also convenient utensils for use in the microwave oven. Cardboard can also be used. Paper is used in the microwave oven as a moisture insulator. Wax coated paper plates and cups should be avoided since the high temperatures that the foods reach may cause the wax to melt. Plastic coated dishes, however, are fine for use in the microwave oven.

Wax paper and paper towels provide an excellent loose cover for foods and help prevent spatters. Do not use paper towels, plates or other utensils made from recycled paper. Recycled paper products may contain certain impurities which could cause the paper to ignite during microwave heating. Some paper products may contain harmful substances.

### PLASTIC AND FOAM UTENSILS

Plastic and foam dishes and containers should not be used for cooking foods with high fat or high sugar content since the heat of the food is too hot for the plastic and may cause it to melt or lose its shape. Cooking pouches designed to withstand boiling and freezing for conventional cooking, work well in the microwave oven. Do not close plastic cooking pouches with the metal tie wraps provided, since they get very hot and will melt the plastic wrap. Any closed pouch or cooking container should be pierced so that steam is allowed to escape. Do not attempt to cook in plastic storage bags as they will not withstand the heat of the food. Plastic wrap may be used to cover foods during cooking. Stretch-type plastic wraps are not suitable for use in the microwave oven because they form too tight a seal. Whenever removing plastic wrap that has been tightly formed around the utensil, just lift the plastic away from you so that the steam can vent and there will be no danger of scalding.

Melamine is not recommended for use in the microwave oven.

### WICKER, WOOD AND STRAW

Wicker, wood and straw may be used in the oven for short periods of time; however, they should not be used for high fat or high sugar content foods since the heat of the food could possibly char the utensil. Wooden handle scrapers, spatulas and spoons may be left in the microwave oven during the cooking process.

## Guidelines for microwave heating

### Several factors should be kept in mind when selecting utensils to be used for microwave heating.

1. A plate with a narrow rim of about 1/2-inch (1.3 cm) is recommended. This keeps the food all at the same level for more even, uniform heating.
2. Casseroles and sauced items should be heated in straight sided containers.
3. Containers should be chosen to be large enough to contain foods as they expand with heating. Milk products are especially subject to boil-overs.
4. Most foods heat better if they are covered. Covering retains the heat that has been created, reduces dehydration and helps keep the oven clean. There should be an opening for steam to escape from the food. Covers should also be non-metallic to allow for proper heating.

### Techniques

1. Microwave cooking is ideal for times when you run out of certain items or for preparation during slow periods.
2. Avoid overcooking. Small portions of food should stand 2-3 minutes following cooking; during this standing time foods will complete cooking. Large portions require longer standing times.
3. When a range of times is given in a recipe (2-3 minutes), always cook the shorter amount of time and check for doneness. Foods can always be returned to the microwave for additional cooking. Overcooked foods are tough or dry.
4. Arrange foods with thicker portions or larger pieces toward the outside of the cooking container. Most foods cook more evenly and faster if covered.
5. The microwave oven is quite useful in reducing broiling times for steaks and chops. Partially prepare the meat in microwave oven, then broil for a shorter period of time.
6. Sliced meats should be at least 1/2-inch (1.3 cm) thick for best heating results. Turning the meat product over once during the heating process will yield more uniform heating.

### Pastries

1. Placing rolls or muffins on a paper towel or napkin or wrapping in a paper towel eliminates excess moisture and gives best results.
2. Avoid overheating. Baked items will be hotter on the inside than on the outside. Overheating causes baked products to be dry and tough.

### Breakfast Items

1. Eggs should be slightly undercooked when preparing them for later reheating in the microwave. Cool quickly and store covered.
2. Arrange foods on platter with easily heated items near center of plate (eggs) and denser items toward outside (sausage).
3. Do not cook eggs in the shell. Pressure will build up inside the shell and it will burst. Do not reheat cooked eggs unless they are scrambled or chopped. Puncture the yolk before cooking eggs.

### Sandwiches

1. Pre-toast bread and cool on air rack. Egg and shortening rich bread gives best results.
2. Sandwich meats should be sliced very thin. When assembling sandwich, place thicker portions toward outside edges.
3. Cover sandwiches and refrigerate no longer than three hours. When ready to heat in the microwave, unwrap and place on paper towel or napkin. Most sandwiches should be heated uncovered unless wrapped in paper towel or napkin. The paper absorbs excess moisture, preventing the sandwich from becoming soggy.
4. Avoid overheating. Filling heats rapidly, and overheated sandwiches become dry and tough.

### **Casseroles**

1. Arrange casseroles with larger pieces or bulk of food around the perimeter of the casserole; depress in center.
2. Casseroles should be heated covered with a non-metallic cover or plastic wrap except casserole with crusts. If tightly covered, puncture plastic wrap or loosen at one corner so steam can escape. Be careful when removing plastic wrap; pull wrap away from you with the tines of a fork.
3. Cover casseroles evenly with sauce or gravy before refrigerating.

### **Vegetables**

1. Arrange vegetables with larger pieces around the perimeter of the dish; depress in center.
2. Small uniform sized vegetables like peas, diced carrots and corn heat easily in the microwave oven. A butter sauce will speed the process.
3. Heat vegetables covered with either a non-metallic cover or plastic wrap. If tightly covered, puncture plastic wrap or loosen at one corner so steam can escape. Be careful when removing plastic wrap; pull wrap away from you with the tines of a fork.
4. Most vegetables should be slightly undercooked when preparing for later reheating in the microwave. Cool quickly and store covered.
5. Microwaved vegetables retain their bright color, flavor and nutrients.

### **Defrosting**

#### **(For R-21LT, R-21LV)**

1. See page 12 for EXPRESS DEFROST directions.
2. Avoid over-defrosting. Foods should be removed from the microwave when they are still slightly icy in the center. Allow foods to stand covered for 1 to 2 minutes to complete defrosting.
3. (For R-21LT) SELECTAPOWERS allows you to defrost food at the power level and speed you choose. Generally defrosting is done at 30% or lower. To use SELECTAPOWERS for defrosting, first program time followed by touching the SELECTAPOWERS pad and the number pad for percentage of power level (for example, 3 represents 30% power). The microwave power will pulse on and off to defrost frozen foods gently without heating.

#### **(For R-21LC)**

See page 7 for DEFROSTING FROZEN FOODS CHART.

## **Timing guide**

Since different foods heat at different rates of speed, there are several influencing factors that should be taken into consideration when heating foods with microwave energy.

1. The lower the initial temperature of a food, the longer it will take to heat in a microwave oven.
2. Since with a microwave oven you are heating with time rather than temperature, it is helpful to know the starting temperatures of the foods. Foods held at room temperature will heat more quickly than refrigerated foods.
3. The different chemical makeups of foods affect the heating times. Highly salted foods heat faster than non-cured items. Animal fats heat more quickly than lean parts of meat. Fats in a colloidal state heat faster than protein (egg yolk cooks before the white).
4. The density of a food is determined by how compact the molecules are arranged within the food. A pound of roast beef is denser than a pound of bread. Even though they weigh the same, the bread contains more air and is therefore less dense. Denser foods require longer heating times.
5. The thicker the food, the longer the heating time. If two foods have the same density, the thinner food will heat before the thicker one.
6. The shape of the food also affects the heating time. Low round foods that are depressed in the center heat faster than highly mounded scooped foods. This has to do again with the density. The denser the mass to be heated, the longer the heating time.
7. The more food placed in the oven cavity at one time, the longer the heating time. This is because there is a constant level of energy coming from the magnetron tube during the heating process. If there are several food items in the oven, they will each absorb some of the energy thus making the total heating time longer. The time required for heating is not directly proportional to the increased amount of food. The heating time should be increased by about 80% for each additional like food item.

## Heating and cooking time guide

Quantity	Item	Approximate Heating Time 100% Power (seconds)	Comment:
<b>Pastries, Rolls and Baked Goods</b>			
2	Biscuit	12	Heat, uncovered, from room temperature
1	Bun	8	Heat, uncovered, from room temperature
1	Danish Pastry	10	Heat, uncovered, from room temperature
1	Dinner, Roll	8	Heat, uncovered, from room temperature
1	Doughnut	10	Heat, uncovered, from room temperature
1	Muffin (small)	10	Heat, uncovered, from room temperature
1 slice	Pie	30	Heat, uncovered, from refrigerated temp.
1	Sweet Roll	10	Heat, uncovered, from room temperature
<b>Breakfast Items</b>			
8 oz. (225 g)	French Toast & Bacon	70-80	Heat, uncovered, from refrig.
8 oz. (225 g)	French Toast & Sausage	70-80	Heat, uncovered, from refrig.
6 oz. (170 g)	Pancakes & Bacon	40-50	Heat, uncovered, from refrig.
6 oz. (170 g)	Pancakes & Sausage	40-50	Heat, uncovered, from refrig.
5 oz. (140 g)	Scrambled Eggs & Bacon	40-50	Heat, covered, from refrig.
5 oz. (140 g)	Scrambled Eggs & Sausage	40-50	Heat, covered, from refrig.
4 strips	Bacon	40-50	Heat, covered, from refrig.
4 links	Sausage	40-50	Heat, covered, from refrig.
<b>Sandwiches</b>			
4-5 oz. (115-140 g)	Bacon & Tomato	30-40	Heat, uncovered, from refrig.
4-5 oz. (115-140 g)	Beef Barbecue	30-40	Heat, uncovered, from refrig.
4-5 oz. (115-140 g)	Burger	30-40	Heat, uncovered, from refrig.
4-5 oz. (115-140 g)	Cheeseburger	40-50	Heat, uncovered, from refrig.
4-5 oz. (115-140 g)	Corned Beef	40-50	Heat, uncovered, from refrig.
2 oz. (55 g)	Frankfurter	20-30	Heat, uncovered, from refrig.
5 oz. (140 g)	Jumbo Frankfurter	30-40	Heat, uncovered, from refrig.
3 1/2 oz. (100 g)	Grilled Cheese	30-40	Heat, uncovered, from refrig.
4 oz. (115 g)	Ham Sandwich	30-40	Heat, uncovered, from refrig.
4-5 oz. (115-140 g)	Ham & Cheese	30-40	Heat, uncovered, from refrig.
5 oz. (140 g)	Italian Sausage	40-50	Heat, uncovered, from refrig.
4-5 oz. (115-140 g)	Pastrami	40-50	Heat, uncovered, from refrig.
4 oz. (115 g)	Roast Beef	40-50	Heat, uncovered, from refrig.
4-5 oz. (115-140 g)	Submarine/Hoagie	40-50	Heat, uncovered, from refrig.
5 oz. (140 g)	Chili Burger	40-50	Heat, covered, from refrig.
4 oz. (115 g)	Chili Dog	30-40	Heat, covered, from refrig.
4 oz. (115 g)	Sloppy Joe	30-40	Heat, covered, from refrig.
<b>Casseroles</b>			
8 oz. (225 g)	Baked Beans	90-100	Heat, covered, from refrig. Stir after reheat.
8 oz. (225 g)	Beef Burgundy	110-120	Heat, covered, from refrig. Stir after reheat.
8 oz. (225 g)	Beef Goulash	90-100	Heat, covered, from refrig. Stir after reheat.
8 oz. (225 g)	Beef Stew	110-120	Heat, covered, from refrig. Stir after reheat.
8 oz. (225 g)	Beef Slices with Gravy	90-100	Heat, covered, from refrig.
8 oz. (225 g)	Cabbage Rolls	100-110	Heat, covered, from refrig.
8 oz. (225 g)	Chicken Fricassee	90-100	Heat, covered, from refrig.
8 oz. (225 g)	Chicken a la King	90-100	Heat, covered, from refrig. Stir after reheat.
8 oz. (225 g)	Chili Con Carne	90-100	Heat, covered, from refrig. Stir after reheat.
8 oz. (225 g)	Creamed Chicken	90-100	Heat, covered, from refrig. Stir after reheat.
8 oz. (225 g)	Lasagna	110-120	Heat, covered, from refrig.
8 oz. (225 g)	Meat Loaf	110-120	Heat, covered, from refrig.
8 oz. (225 g)	Macaroni (beef sauce)	90-100	Heat, covered, from refrig. Stir after reheat.

## Heating and Cooking Time Guide Con't

Quantity	Item	Approximate Heating Time 100% Power(seconds)	Comment:
8 oz. (225 g)	Macaroni (cheese sauce)	70-80	Heat, covered, from refrig. Stir after reheat.
8 oz. (225 g)	Stuffed Peppers	100-110	Heat, covered, from refrig.
8 oz. (225 g)	Pot Pie	100-110	Heat, covered, from refrig.
8 oz. (225 g)	Ravioli	100-110	Heat, covered, from refrig.
8 oz. (225 g)	Shrimp Creole	80-90	Heat, covered, from refrig.
8 oz. (225 g)	Shrimp Newburg	80-90	Heat, covered, from refrig.
8 oz. (225 g)	Short Ribs of Beef	100-110	Heat, covered, from refrig.
8 oz. (225 g)	Spaghetti	80-90	Heat, covered, from refrig.
8 oz. (225 g)	Stew, Chicken	100-110	Heat, covered, from refrig.
8 oz. (225 g)	Tuna Casserole	100-110	Heat, covered, from refrig.
8 oz. (225 g)	Turkey Slices	90-100	Heat, covered, from refrig.

### Vegetables

4 oz. (115 g)	Asparagus	40-50	Heat, covered, from refrig.
4 oz. (115 g)	Beans, Green	40-50	Heat, covered, from refrig.
4 oz. (115 g)	Broccoli	40-50	Heat, covered, from refrig.
4 oz. (115 g)	Carrot Slices	40-50	Heat, covered, from refrig.
4 oz. (115 g)	Cauliflower	40-50	Heat, covered, from refrig.
4 oz. (115 g)	Corn Niblets	40-50	Heat, covered, from refrig.
4 oz. (115 g)	Mushrooms	30-40	Heat, covered, from refrig.
4 oz. (115 g)	Peas	30-40	Heat, covered, from refrig.
4 oz. (115 g)	Potatoes au Gratin	50-60	Heat, covered, from refrig.
4 oz. (115 g)	Potatoes (pre-baked)	50-60	Heat, uncovered, from refrig.

Quantity	Item	Approximate Heating Time 100% Power	Comment:
----------	------	--	----------

### Plated Meals

1 small	Plated Meal	2-2½ min.	Heat, covered, from refrig.
1 large	Plated Meal	2½-3½ min.	Heat, covered, from refrig.

### Primary Cooking

4 slices	Bacon	2½-3 min.	Cook between paper towels.
1 pound (450 g)	Bacon (precook to reheat)	8-10 min.	Cook between paper towels.
2	Scrambled Eggs	50-60 sec.	Stir during cooking.
12	Scrambled Eggs (precook to reheat)	4½-5 min.	Stir during cooking.
1 ear	Corn on the Cob	2-2½ min.	Cover, turn over during cooking.
1 medium	Potato	3½-4 min.	Wash, dry, prick.
2 medium	Potatoes	7-8 min.	Cook on paper towel. Stand.
40 oz. (1.1 kg)	Frozen Broccoli Pieces	14-16 min.	Rearrange during cooking.
24 oz. (675 g)	Frozen Broccoli Spears	7-9 min.	Rearrange during cooking.
96 oz. (2.7 kg)	Refrigerated Lasagna	(R-21LV) 15 min. at 100 % (R-21LT) 10 min. at 100 % + 17 min. at 50%	Cover with lid for first half of cooking time. Uncover for second half of cooking time. After cooking, allow to stand, covered, for least 5 minutes to make cutting and serving easier.

## REMINDERS

1. Do not operate the oven empty. Either food or water should always be in the oven during operation to absorb microwave energy.
2. Limit use of metal to those specific examples given in this booklet. Generally, metal should not be used in the microwave oven during operation.
3. Do not heat eggs in the shell. Pressure will build up inside the shell and it will explode. Do not reheat cooked eggs unless they are scrambled or chopped. Puncture the yolk before heating eggs.
4. Do not heat oil or fat for deep fat frying.
5. Pierce the "skin" of potatoes, whole squash, apples or any fruit, vegetable or meat with a skin covering before heating.
6. Use only popcorn packaged in special microwavable packages. Pop using 100% power. Listen carefully when popping corn. When popping slows to one or two seconds between pops, remove from oven. Should you ever smell scorching, remove bag from oven immediately. If any unpopped kernels remain, do not try to re-pop; it may cause a fire.
7. Do not use paper towels, plates or other utensils made from recycled paper for microwave heating. Recycled paper products may contain certain impurities which could cause the paper to ignite during microwave heating.
8. Stir liquids briskly before heating and allow to stand at least for 20 seconds after heating before stirring or drinking to avoid eruption.

## SPECIFICATIONS

AC Line Voltage AC Power Required Output Power Frequency	Single phase 120V, 60Hz, A.C. only 1.55 kW 14 A 1000W★ 2450 MHz
Outside Dimensions	20 <sup>1</sup> / <sub>2</sub> "(W) x 16"(D) x 12 <sup>1</sup> / <sub>8</sub> "(H) 520mm(W) x 406mm(D) x 309mm(H) (including feet)
Cavity Dimensions	13 <sup>7</sup> / <sub>8</sub> "(W) x 14 <sup>5</sup> / <sub>8</sub> "(D) x 8 <sup>1</sup> / <sub>8</sub> "(H) 353mm(W) x 370mm(D) x 207mm(H)
Weight	Approx. 37 lbs./17 kg

★ IEC Test Procedure

The International Electrotechnical Commission's standardized method for measuring output wattage. This test method is widely recognized.

In Compliance with Standards set by

FCC – Federal Communications Commission Authorized.

DHHS – Complies with Department of Health and Human Services (DHHS) rule, CFR, Title 21 Chapter I, Subchapter J.



– This symbol on the nameplate means the product is certified by NSF International (NSF-4).



– This symbol on the nameplate means the product is listed by Underwriters Laboratories, Inc.

# AUTO-TOUCH GUIDE for R-21LT, R-21LV

For more complete information and safety precautions, refer to your Operation Manual.

<p><b>MEMORY CHECK</b></p> <p>Suppose you want to know the information programmed into the memory.</p> <ol style="list-style-type: none"> <li>1. Touch CHECK pad.</li> <li>2. Touch number pad 1 .</li> </ol>	<p style="text-align: center;">CHECK</p> <p style="text-align: center;">1</p>	<p><b>COUNTER CHECK</b></p> <ol style="list-style-type: none"> <li>1. Touch CHECK pad 2 times.</li> </ol> <p>Total count will be displayed.</p>	<p style="text-align: center;">CHECK X 2</p>
<p><b>MULTIPLE SEQUENCE COOKING (R-21LT)</b></p> <p>Suppose you want to cook for 4 minutes at 60% and then continue to cook for 2 minutes at 30%.</p> <ol style="list-style-type: none"> <li>1. Enter cooking time for 1 stage.</li> <li>2. Enter power level for 1st stage.</li> <li>3. Enter cooking time for 2nd stage.</li> <li>4. Enter power level for 2nd stage.</li> <li>5. Touch START pad.</li> </ol>		<p>Count of memory 1 , etc.</p> <p>Count of manual cooking</p> <p>Count of Express Defrost</p>	<p style="text-align: center;">1</p> <p style="text-align: center;">SELECTATIME</p> <p style="text-align: center;">EXPRESS DEFROST</p>
<p><b>To clear the number of times:</b></p> <p>Suppose you want to clear the times in memory 1.</p> <ol style="list-style-type: none"> <li>1. Touch CHECK pad 2 times.</li> <li>2. Touch number pad 1 .</li> <li>3. Touch SET pad.</li> </ol> <p>Any count can be canceled by touching the SET pad during the checking mode.</p>		<p>Suppose you want to clear the times in memory 1.</p> <ol style="list-style-type: none"> <li>1. Touch CHECK pad 2 times.</li> <li>2. Touch number pad 1 .</li> <li>3. Touch SET pad.</li> </ol>	<p style="text-align: center;">CHECK X 2</p> <p style="text-align: center;">1</p> <p style="text-align: center;">SET</p>

## USER GUIDE for R-21LC

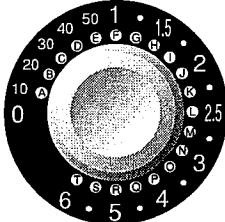
<p><b>OPERATION</b></p> <ol style="list-style-type: none"> <li>1. Set the Light Up Dial for the appropriate cooking time at 100% power.</li> </ol> <p>The oven will start cooking immediately.</p> <p>To stop the oven, open the door or turn the Light Up Dial to "0".</p>	
---	---

# AUTO-TOUCH GUIDE for R-21LT, R-21LV

For more complete information and safety precautions, refer to your Operation Manual.

<p><b>COOK WITH MEMORY</b></p> <p>Suppose you want to cook using memory.</p> <p>1. Touch number pad 1 . (For R-21LT only)</p> <p>If you want to use memory 11-20, touch desired number pad twice within 1 second.</p>	<p style="text-align: center;">1</p>	<p><b>TIME COOKING</b></p> <p>Suppose you want to cook for 2 minutes and 30 seconds at 50%.</p> <p>1. Touch SELECTATIME</p> <p>2. Enter cooking time.</p> <p>3. Touch SELECTAPOW (For R-21LT only)</p> <p>4. Enter power level. (For R-21LT only)</p> <p>5. Touch START pad.</p>	<p style="text-align: center;">SELECTATIME</p> <p style="text-align: center;">2 3 0</p> <p style="text-align: center;">SELECTAPOW</p> <p style="text-align: center;">5</p> <p style="text-align: center;">START</p>
<p><b>COOKING DOUBLE QUANTITY WITH MEMORY</b></p> <p>Suppose you want to cook 2 servings by memory 1.</p> <p>1. Place food in oven. Touch DOUBLE QUANTITY pad.</p> <p>2. Touch number pad 1 .</p>	<p style="text-align: center;">DOUBLE QUANTITY</p> <p style="text-align: center;">1</p>	<p><b>EXPRESS DEFROST</b></p> <p>Suppose you want to defrost for 3 minutes and 30 seconds.</p> <p>1. Touch EXPRESS DEFROST pad.</p> <p>2. Enter desired defrost time. (Refer to Express Defrost Chart on page 12.)</p> <p>3. Touch START pad.</p> <p>4. Midway through the defrosting cycle, CHECK will light in the display and an audible signal will be heard. You may open the door, turn food over and shield any warm portions. Close the door.</p> <p>5. Touch START pad.</p>	<p style="text-align: center;">EXPRESS DEFROST</p> <p style="text-align: center;">3 3 0</p> <p style="text-align: center;">START</p> <p>If you do not open the door when an audible signal sounds, the defrosting cycle will continue and the defrosting time will count down to 0.</p> <p style="text-align: center;">START</p>
<p><b>MEMORY PROGRAM ENTRY</b></p> <p>Suppose you want to set 4 minutes at 60% for the 1st stage for 1 serving in the memory 1.</p> <p>1. Touch SET pad 2 times within 2 seconds.</p> <p>2. Touch number pad 1 .</p> <p>3. Enter cooking time.</p> <p>4. Enter power level.</p> <p>5. Touch SET pad 2 times.</p>	<p style="text-align: center;">SET X 2</p> <p style="text-align: center;">1</p> <p style="text-align: center;">SELECTATIME</p> <p style="text-align: center;">4 0 0</p> <p style="text-align: center;">SELECTAPOW</p> <p style="text-align: center;">6</p> <p style="text-align: center;">SET X 2</p>		

## SHARP®

SHARP ELECTRONICS CORPORATION  
Sharp Plaza, Mahwah, New Jersey 07430-2135

TINSEB126WRRZ-D61 Printed in Thailand  
2006.7