

# over the counter microwave oven operation manual & installation instructions

models

---

## R-1210 R-1211



Read all  
instructions  
carefully  
before using  
the oven.

**SHARP®** Carousel®

# FOR CUSTOMER ASSISTANCE

To aid in reporting this microwave oven in case of loss or theft, please record below the model number and serial number located on the unit. We also suggest you record all the information listed and retain for future reference.

MODEL NUMBER _____	SERIAL NUMBER _____
DATE OF PURCHASE _____	
DEALER _____	TELEPHONE _____
SERVICER _____	TELEPHONE _____

**TO PHONE:**

**DIAL 1-800-BE-SHARP ( 237-4277 ) for :**  
SERVICE (for your nearest Sharp Authorized Servicer)  
PARTS (for your authorized parts distributor)  
ADDITIONAL CUSTOMER INFORMATION

**DIAL 1-800-642-2122 for :**  
ACCESSORIES and COOKBOOK

**TO WRITE:**

Sharp Electronics Corporation  
Customer Assistance Center  
1300 Naperville Drive  
Romeoville, IL 60446-1091

**TO ACCESS INTERNET:** [www.sharp-usa.com](http://www.sharp-usa.com)

Please provide the following information when you write or call: model number, serial number, date of purchase, your complete mailing address (including zip code), your daytime telephone number (including area code) and description of the problem.

## PRECAUTIONS TO AVOID POSSIBLE EXPOSURE TO EXCESSIVE MICROWAVE ENERGY

- (a) Do not attempt to operate this oven with the door open since open-door operation can result in harmful exposure to microwave energy. It is important not to defeat or tamper with the safety interlocks.
- (b) Do not place any object between the oven front face and the door or allow soil or cleaner residue to accumulate on sealing surfaces.
- (c) Do not operate the oven if it is damaged. It is particularly important that the oven door close properly and that there is no damage to the: (1) door (bent), (2) hinges and latches (broken or loosened), (3) door seals and sealing surfaces.
- (d) The oven should not be adjusted or repaired by anyone except properly qualified service personnel.

# CONTENTS

<b>For Customer Assistance .....</b>	<b>2</b>	<b>Special Features .....</b>	<b>18-24</b>
<b>Precautions to Avoid Possible</b>		Sensor Cook .....	18
<b>Exposure to Excessive</b>		Reheat .....	19
<b>Microwave Energy .....</b>	<b>2</b>	Sensor Cook Center .....	20
<b>Contents .....</b>	<b>3</b>	Sensor Cook Recipes .....	21
<b>Consumer Limited Warranty .....</b>	<b>4</b>	Defrost Center .....	22
<b>Product Information Card .....</b>	<b>4</b>	Instant Sensor .....	23
<b>Important Safety Instructions .....</b>	<b>5</b>	Keep Warm Plus .....	24
<b>Unpacking and Installation Instructions ..</b>	<b>6-11</b>	<b>Other Convenient Features .....</b>	<b>25-26</b>
Unpacking and Examining Your Oven .....	6	Custom Help .....	25
Installation Instructions .....	6-10	Demonstration Mode .....	25
Optional Accessories .....	11	Help .....	25
Checklist for Installation .....	11	Multiple Sequence Cooking .....	26
<b>Information You Need to Know .....</b>	<b>12-14</b>	Minute Plus .....	26
About Your Oven .....	12	More or Less Time Adjustment .....	26
About Food .....	12	Timer .....	26
About Utensils and Coverings .....	13	Accent Light and Task Light .....	26
About Children and the Microwave .....	13	<b>Cleaning and Care .....</b>	<b>27</b>
About Microwave Cooking .....	14	<b>Replacing Parts .....</b>	<b>27</b>
About Safety .....	14	<b>Service Call Check .....</b>	<b>28</b>
<b>Part Names .....</b>	<b>15-16</b>	<b>Specifications .....</b>	<b>28</b>
<b>Before Operating .....</b>	<b>16</b>	<b>The Ultimate Accessory .....</b>	<b>29</b>
To Set the Clock .....	16	<b>Cookbook Order Form .....</b>	<b>29</b>
Stop/Clear .....	16	<b>Guia Auto-Touch .....</b>	<b>30-31</b>
<b>Manual Operation .....</b>	<b>17</b>	<b>Auto-Touch Guide .....</b>	<b>31-Back Cover</b>
Time Cooking .....	17		
To Set Power Level .....	17		
Manual Defrost .....	17		

# CONSUMER LIMITED WARRANTY

SHARP ELECTRONICS CORPORATION warrants to the first consumer purchaser that this Sharp brand product (the "Product"), when shipped in its original container, will be free from defective workmanship and materials, and agrees that it will, at its option, either repair the defect or replace the defective Product or part thereof with a new or remanufactured equivalent at no charge to the purchaser for parts or labor for the period(s) set forth below.

This warranty does not apply to any appearance items of the Product nor to the additional excluded item(s) set forth below nor to any Product the exterior of which has been damaged or defaced, which has been subjected to misuse, abnormal service or handling, or which has been altered or modified in design or construction.

In order to enforce the rights under this limited warranty, the purchaser should follow the steps set forth below and provide proof of purchase to the servicer.

The limited warranty described herein is in addition to whatever implied warranties may be granted to purchasers by law. ALL IMPLIED WARRANTIES INCLUDING THE WARRANTIES OF MERCHANTABILITY AND FITNESS FOR USE ARE LIMITED TO THE PERIOD(S) FROM THE DATE OF PURCHASE SET FORTH BELOW. Some states do not allow limitations on how long an implied warranty lasts, so the above limitation may not apply to you.

Neither the sales personnel of the seller nor any other person is authorized to make any warranties other than those described herein, or to extend the duration of any warranties beyond the time period described above on behalf of Sharp.

The warranties described herein shall be the sole and exclusive warranties granted by Sharp and shall be the sole and exclusive remedy available to the purchaser. Correction of defects, in the manner and for the period of time described herein, shall constitute complete fulfillment of all liabilities and responsibilities of Sharp to the purchaser with respect to the Product, and shall constitute full satisfaction of all claims, whether based on contract, negligence, strict liability or otherwise. In no event shall Sharp be liable, or in any way responsible, for any damages or defects in the Product which were caused by repairs or attempted repairs performed by anyone other than an authorized servicer. Nor shall Sharp be liable or in any way responsible for any incidental or consequential economic or property damage. Some states do not allow the exclusion of incidental or consequential damages, so the above exclusion may not apply to you. THIS WARRANTY GIVES YOU SPECIFIC LEGAL RIGHTS. YOU MAY ALSO HAVE OTHER RIGHTS WHICH VARY FROM STATE TO STATE.

**Your Product Model Number & Description:**

R-1210 or R-1211 Home Use Carousel™ Microwave Oven. (Be sure to have this information available when you need service for your Product.)

**Warranty Period for this Product:**

One (1) year parts and labor in-home service. The warranty period continues for an additional six (6) years, for a total of seven (7) years, with respect to the magnetron tube in the Product for parts only. Labor and the servicer trip charge are not provided free of charge for this additional period.

**Additional Item(s) Excluded from Warranty Coverage (if any):**

Non-functional accessories, turntable and light bulbs.

**Where to Obtain Service:**

From a Sharp Authorized Servicer located In the United States. Be sure to have **Proof of Purchase** available. For in-home service, the servicer will come to the unit's location. If it is necessary to remove the unit for repair, the servicer will reinstall the unit at no extra charge, provided it was installed according to Sharp's Installation Instructions. To find the location of the nearest Sharp Authorized Servicer, call Sharp toll free at 1-800-BE-SHARP (1-800-237-4277).

TO OBTAIN SUPPLY, ACCESSORY OR PRODUCT INFORMATION, CALL **1-800-BE-SHARP** OR VISIT **www.sharp-usa.com**. SAVE THE PROOF OF PURCHASE AS IT IS NEEDED SHOULD YOUR OVEN EVER REQUIRE WARRANTY SERVICE.

## PRODUCT INFORMATION CARD

The product information card should be completed within ten days of purchase and returned. It is necessary to write the model and serial numbers, found on the nameplate in the oven cavity, on the product information card. We will keep it on file and help you access the information in case of loss, damage or theft. This will also enable us to contact you in the unlikely event that any adjustments or modifications are ever required for your oven.

# IMPORTANT SAFETY INSTRUCTIONS

When using electrical appliances basic safety precautions should be followed, including the following:

**WARNING** - To reduce the risk of burns, electric shock, fire, injury to persons or exposure to excessive microwave energy:

1. **READ ALL INSTRUCTIONS BEFORE USING THE APPLIANCE.**
2. Read and follow the specific **“PRECAUTIONS TO AVOID POSSIBLE EXPOSURE TO EXCESSIVE MICROWAVE ENERGY”** on inside front cover.
3. This appliance must be grounded. Connect only to properly grounded outlet. See **“GROUNDING INSTRUCTIONS”** on page 7.
4. Install or locate this appliance only in accordance with the provided installation instructions.
5. Some products such as whole eggs and sealed containers—for example, closed glass jars—may explode and should not be heated in this oven.
6. Stir liquids briskly before, during and after heating to avoid eruption. Be careful.
7. Use this appliance only for its intended use as described in this manual. Do not use corrosive chemicals or vapors in this appliance. This type of oven is specifically designed to heat, cook or dry food. It is not designed for industrial or laboratory use.
8. As with any appliance, close supervision is necessary when used by children.
9. Do not operate this appliance if it has a damaged cord or plug, if it is not working properly or if it has been damaged or dropped.
10. This appliance should be serviced only by qualified service personnel. Contact nearest Sharp Authorized Servicer for examination, repair or adjustment.
11. Do not cover or block any openings on the appliance.
12. Do not store or use this appliance outdoors. Do not use this product near water—for example, near a kitchen sink, in a wet basement or near a swimming pool, and the like.
13. Do not immerse cord or plug in water.
14. Keep cord away from heated surfaces.
15. Do not let cord hang over edge of table or counter.
16. See door surface cleaning instructions on page 27.
17. To reduce the risk of fire in the oven cavity:
  - a. Do not overcook food. Carefully attend appliance if paper, plastic or other combustible materials are placed inside the oven to facilitate cooking.
  - b. Remove wire twist-ties from paper or plastic bags before placing bag in oven.
  - c. If materials inside the oven should ignite, keep oven door closed, turn oven off and disconnect the power cord or shut off power at the fuse or circuit breaker panel.**
  - d. Do not use the cavity for storage purposes. Do not leave paper products, cooking utensils or food in the cavity when not in use.
18. For a wall mounted oven, observe the following instructions:
  - a. Do not operate any heating or cooking appliance beneath this appliance.
  - b. Do not mount unit directly above a heating or cooking appliance.
  - c. Do not mount over a sink.
19. If the oven light fails, consult a SHARP AUTHORIZED SERVICER.

## SAVE THESE INSTRUCTIONS

# UNPACKING AND INSTALLATION INSTRUCTIONS

## UNPACKING AND EXAMINING YOUR OVEN

Open the bottom of the carton, bend the carton flaps back and tilt the oven over to rest on plastic foam pad. Lift carton off oven and remove all packing materials, WALL and TOP CABINET TEMPLATE, Turntable, and Turntable Support. SAVE THE CARTON AS IT MAY MAKE INSTALLATION EASIER.

1. Remove the feature sticker from the outside of the door, if there is one.
2. DO NOT REMOVE THE WAVEGUIDE COVER, which is located on the right side wall of the oven cavity. Check to see that there is a WALL TEMPLATE and TOP CABINET TEMPLATE. Read enclosures and SAVE the Operation Manual.

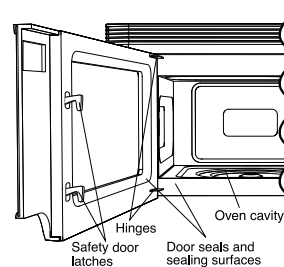

Check the oven for any damage, such as misaligned or bent door, damaged door seals and sealing surfaces, broken or loose door hinges and latches and dents inside the cavity or on the door. If there is any damage, do not operate the oven and contact your dealer or SHARP AUTHORIZED SERVICER.

## INSTALLATION INSTRUCTIONS

Please read all instructions thoroughly before installing the Over the Counter Microwave Oven. Two people are recommended to install this product.

If a new electrical outlet is required, its installation should be completed by a qualified electrician before the Microwave Oven is installed. See 3 ELECTRICAL GROUNDING INSTRUCTIONS on page 7.

### 1 MOUNTING SPACE

This Microwave Oven requires a mounting space on a wall as shown in Figure 1. It is designed to be used under standard 24-inch wide wall cabinets.

Figure 1

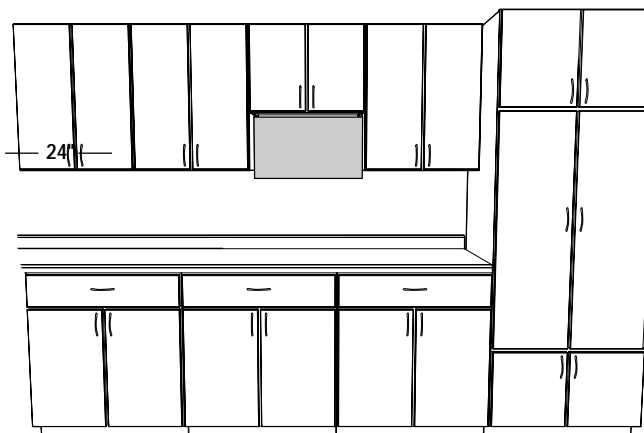

### 2 WALL CONSTRUCTION

This Microwave Oven should be mounted against and supported by a flat vertical wall. The wall must be flat for proper installation. If the wall is not flat, use spacers to fill in the gaps. Wall construction should be a minimum of 2" x 4" wood studing and 3/8" or more thick dry wall or plaster/lath. The mounting surfaces must be capable of supporting weight of 110 pounds—the oven and contents—AND the weight of all items which would normally be stored in the top cabinet above the unit.

The unit should be attached to a minimum of one 2" x 4" wall stud.

To find the location of the studs, one of the following methods may be used:

- A. Use a stud finder, a magnetic device which locates the nails in the stud.
- B. Use a hammer to tap lightly across the mounting surface to find a solid sound. This will indicate stud location.

The center of the stud can be located by probing the wall with a small nail to find the edges of the stud and then placing a mark halfway between the edges. The center of any adjacent studs will normally be 16" or 24" to either side of this mark.

# UNPACKING AND INSTALLATION INSTRUCTIONS

## 3 ELECTRICAL GROUNDING INSTRUCTIONS

This appliance must be grounded. This oven is equipped with a cord having a grounding wire with a grounding plug. It must be plugged into a wall receptacle that is properly installed and grounded in accordance with the National Electrical Code and local codes and ordinances. In the event of an electrical short circuit, grounding reduces risk of electric shock by providing an escape wire for the electric current.

**WARNING** - Improper use of the grounding plug can result in a risk of electric shock.

### Electrical Requirements

The electrical requirements are a 120 volt 60 Hz, AC only, 15 amp. or more protected electrical supply. It is recommended that a separate circuit serving only the oven be provided.

The oven is equipped with a 3-prong grounding plug. It must be plugged into a wall receptacle that is properly installed and grounded. **DO NOT UNDER ANY CIRCUMSTANCES CUT OR REMOVE THE GROUNDING PIN FROM THE PLUG.**

The single grounded receptacle should be located inside the cabinet directly above the Microwave Oven mounting location as shown in Figure 2.

### NOTE:

1. If you have any questions about the grounding or electrical instructions, consult a qualified electrician or serviceperson.
2. Neither Sharp nor the dealer can accept any liability for damage to the oven or personal injury resulting from failure to observe the correct electrical connection procedures.

### Radio or TV Interference

Should there be any interference caused by the microwave oven to your radio or TV, check that the microwave oven is on a different electrical circuit, relocate the radio or TV as far away from the oven as feasible or check position and signal of receiving antenna.

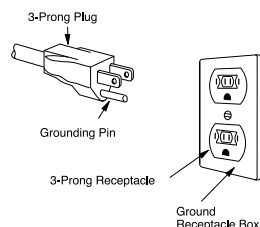
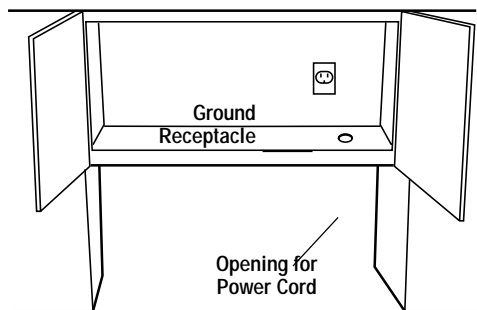

Figure 2



## 4 TOOLS RECOMMENDED FOR INSTALLATION

- Phillips Screwdriver
- Electric Drill
- 1/2", 5/8" and 3/32" Drill Bits
- 1-1/2" Wood Bit or Metal Hole Cutter (if metal cabinet is used)
- Saw to cut exhaust opening (if needed)
- Protective Drop Cloth for product and range - you may also use carton for protection
- Scissors
- Pencil
- Measure
- Tape

# UNPACKING AND INSTALLATION INSTRUCTIONS

## 5 INSTALLATION HARDWARE

The INSTALLATION HARDWARE items 1 - 7 are in a small bag. Item 8 is packed separately. All items are in a small carton packed below the oven.

ITEM	NAME	QUANTITY	PART CODE
1	Wood Screw 5 X 30 mm	6	XTSSD50P35000
2	Toggle Bolt with nuts #10 - 24 X 50 mm	4	LX-BZ0195WRE0
3	Top Cabinet Screw 5 X 60 mm	2	XBRSD50P60000
4	Power Cord Hanger	1	LX-MZB001MRE0
5	Tapping Screw 4 x 12 mm	3	XOTSD40P12000
6	Flat Washer 30 mm diameter	2	XWHSD50-16300
7	Grommet	1	LBSHC0040MRE0
8	Scale Plate	2	LANG-B003MRP0

Figure 3

Parts shown not to common scale.

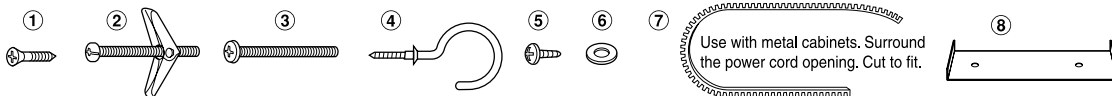

## 6 PREPARATION OF THE OVEN

1. Turn oven on the side. See Figure 4.
2. Follow steps (A)-(D) to remove mounting plate from the back of the oven as shown in Figure 4.
  - (A) Release mounting plate by pulling out the lever that is on the bottom of the oven. See Figure 5.
  - (B) When lever is out, pull that side of the mounting plate away from the oven. See Figure 4.
  - (C) Repeat step (A) on other side.
  - (D) Repeat step (B) on other side.

Figure 4

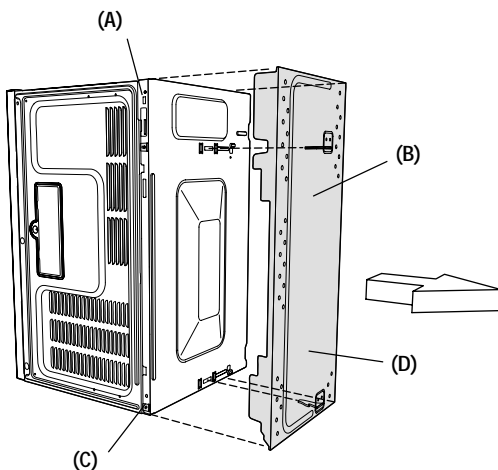
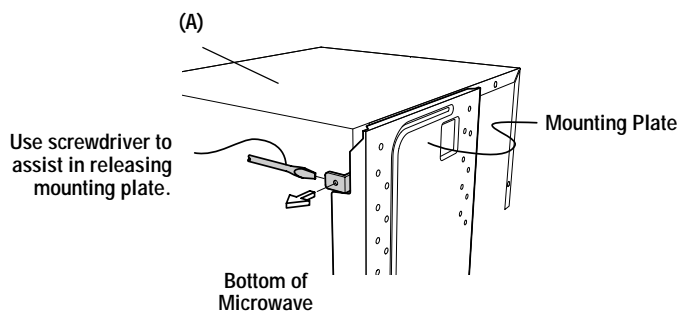

Figure 5





# UNPACKING AND INSTALLATION INSTRUCTIONS

## 7 OVEN INSTALLATION

THIS OVEN CANNOT BE PROPERLY INSTALLED WITHOUT REFERRING TO THE MOUNTING INSTRUCTIONS FOUND ON WALL AND TOP CABINET TEMPLATES.

THE NEXT STEP IS TO READ AND FOLLOW MOUNTING INFORMATION ON WALL AND TOP CABINET TEMPLATES. **THIS OVEN MUST BE ATTACHED TO AT LEAST ONE WALL STUD. SEE WALL CONSTRUCTION ON PAGE 6.**

WHEN DONE WITH TEMPLATES, PROCEED TO MOUNTING SCALE PLATE SECTION.

### MOUNTING SCALE PLATE

Attach 2 Scale Plates 8 with tape (not included). See Figure 6 and WALL TEMPLATE for locations.

#### NOTE:

This Microwave Oven may not be built-in directly over gas or electric ovens or cooktops. To reduce the risk of fire or electrical shock, install at least 13 3/16" above the countertop.

Figure 6

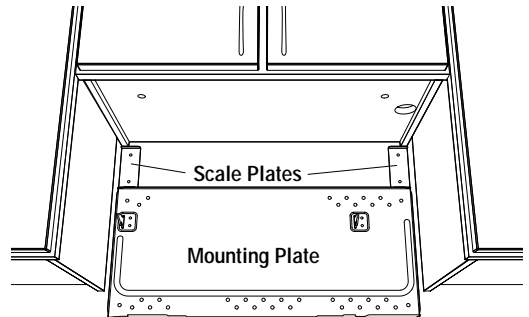

### MOUNTING PLATE

1. Separate 4 Toggle Bolts 2, packed in the INSTALLATION HARDWARE, from the Toggle Nuts.
2. Match 5/8" holes (not in studs), drilled through WALL AND TOP CABINET TEMPLATE into wall to corresponding holes on Mounting Plate.
3. Insert Toggle Bolts into matched openings on Mounting Plate. Put Toggle Nuts on Toggle Bolts. See Figure 7.
4. Position the Mounting Plate with the Toggle Bolts attached at the wall location and insert Toggle Nuts and Bolts through the holes in the wall with the Toggle Nuts closed. Figure 8. Use Wood Screws 1 to attach the Mounting Plate to studs.

NOTE: Before insertion, be sure you leave a space more than the thickness of the wall between the Mounting Plate and the end of each of the Toggle Nuts (in the closed position). If you do not leave enough space, the Toggle Nut will not be able to open on the other side of the wall. **Also, once a Toggle Nut opens, it cannot be withdrawn from the hole; therefore make sure all of the Toggles are in the correct position before insertion.**

5. Align the Mounting Plate carefully and hold in position while tightening Toggle Bolts. Pull Toggle Bolt toward you and turn clockwise to tighten. Figure 9.

Figure 7

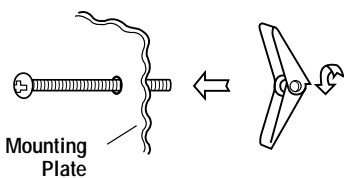

Figure 8

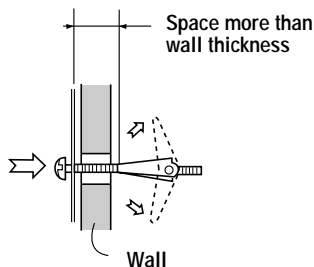
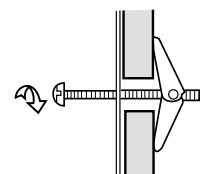

Figure 9



# UNPACKING AND INSTALLATION INSTRUCTIONS

## 8 PREPARATION AND USE OF THE CARTON TO ASSIST IN THE INSTALLATION OF THE MICROWAVE OVEN

Utilization of the carton may make installation easier.

1. Place carton upside down. See Figure 10.
2. Using cutting line around the carton, cut into two pieces (A) and (B). See Figure 11.
3. Position oven to assist in mounting to the wall. See Figure 12.

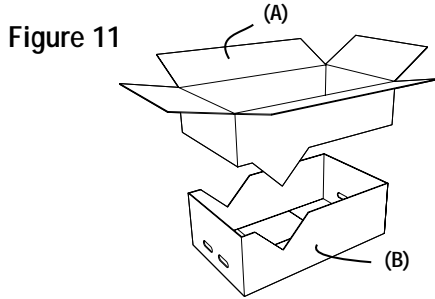

Figure 11

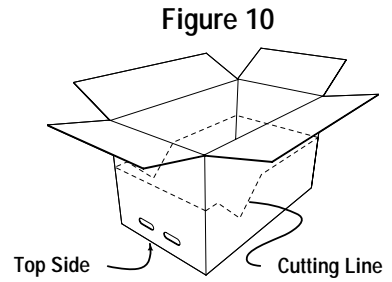

Figure 10

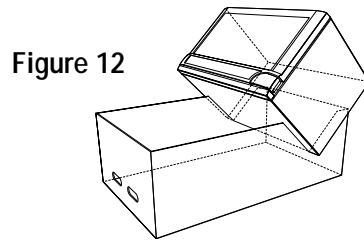

Figure 12

## MOUNTING OVEN TO THE WALL

Two people are recommended to attach the Microwave Oven to the Mounting Plate.

1. Thread the Power Supply Cord through the hole made in the bottom of the top cabinet. Install the oven by snapping it onto the Mounting Plate. See Figure 13.
2. Use two Tapping Screws 5 to secure the levers that are on the bottom of the oven. See Figure 14.
3. Use two Top Cabinet Screws 3 and two Flat Washers 6, supplied in the INSTALLATION HARDWARE, to attach the unit to the top cabinet. See Figure 15.
4. Make a bundle of the Power Supply Cord and attach it to the inside of the cabinet using the Power Cord Hanger 4. See Figure 15.

Figure 13

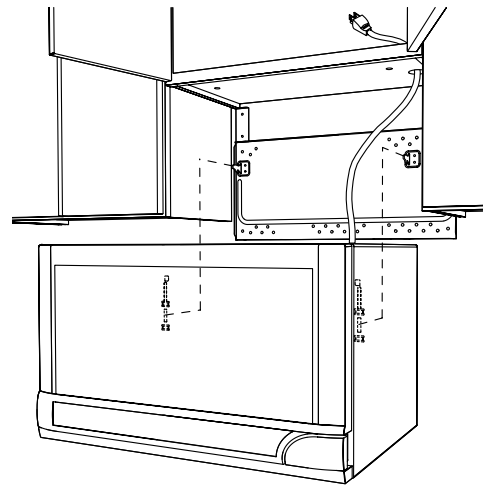

Figure 14

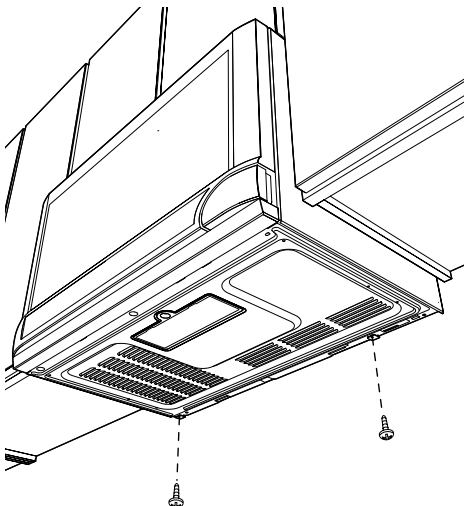
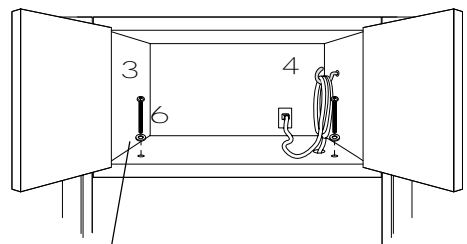

Figure 15



NOTE:  
Screw length has been designed to accommodate 3/8" and above cabinet depth. If less, screw must be cut to required length.

# UNPACKING AND INSTALLATION INSTRUCTIONS

## OPTIONAL ACCESSORIES

Optional Accessory Bars (RK-OTC120) with "S" hooks can be ordered directly from the Sharp Accessories and Supplies Center. Each kit contains 3 bars and 8 "S" hooks. Have your credit card number available and call toll-free: **1-800-642-2122** to have the Accessory Bars sent to your address.

**WARNING: WHEN HANGING UTENSILS FROM "S" HOOKS, DO NOT HANG ITEMS SUCH AS DISHTOWELS THAT MAY BLOCK THE OVEN VENTS. THE TOTAL UTENSIL WEIGHT SHOULD NOT EXCEED 5 POUNDS PER BAR.**

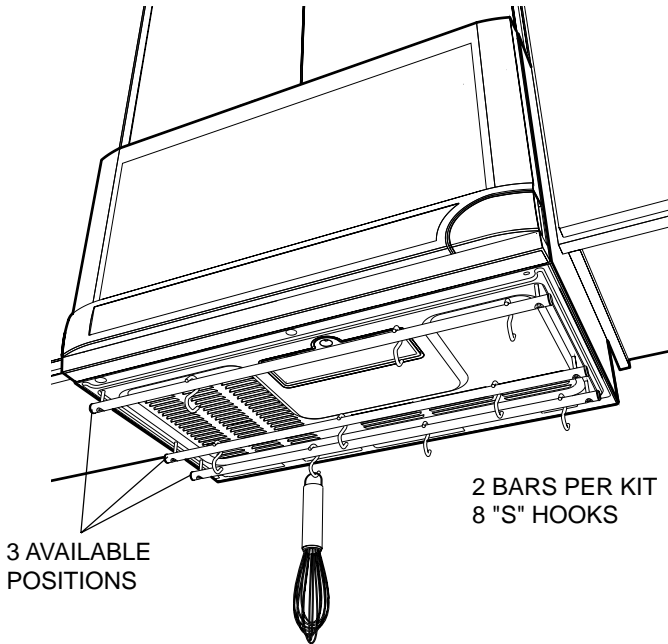

## CHECKLIST FOR INSTALLATION

1. Make sure the unit has been installed according to all of the Installation Instructions, the Wall and Top Cabinet Templates.
2. Plug in the power cord.
3. Keep the Operation Manual and Installation Instructions.

# INFORMATION YOU NEED TO KNOW

## ABOUT YOUR OVEN

This Operation Manual is valuable: read it carefully and always save it for reference.

A good microwave cookbook is a valuable asset. Check it for microwave cooking principles, techniques, hints and recipes. See page 29 for ordering the Ultimate Accessory, the SHARP CAROUSEL MICROWAVE COOKBOOK.

**NEVER** use the oven without the turntable and support nor turn the turntable over so that a large dish could be placed in the oven. The turntable will turn both clockwise and counterclockwise.

**ALWAYS** have food in the oven when it is on to absorb the microwave energy.

When using the oven at power levels below 100%, you may hear the magnetron cycling on and off. It is normal for the exterior of the oven to be warm to the touch when cooking or reheating.

Condensation is a normal part of microwave cooking. Room humidity and the moisture in food will influence the amount of moisture that condenses in the oven. Generally, covered foods will not cause as much condensation as uncovered ones. Vents on the oven back must not be blocked.

The oven is for food preparation only. It should not be used to dry clothes or newspapers.

All ovens are rated 1100 watts by using the IEC Test Procedure. In using recipes or package directions, check food a minute or two before the minimum time and add time accordingly.

## ABOUT FOOD

FOOD	DO	DON'T
<b>Eggs, sausages, nuts, seeds, fruits &amp; vegetables</b>	<ul style="list-style-type: none"><li>• Puncture egg yolks before cooking to prevent "explosion".</li><li>• Pierce skins of potatoes, apples, squash, hot dogs and sausages so that steam escapes.</li></ul>	<ul style="list-style-type: none"><li>• Cook eggs in shells.</li><li>• Reheat whole eggs.</li><li>• Dry nuts or seeds in shells.</li></ul>
<b>Popcorn</b>	<ul style="list-style-type: none"><li>• Use specially bagged popcorn for the microwave oven.</li><li>• Listen while popping corn for the popping to slow to 1 or 2 seconds or use special <b>POPCORN</b> pad.</li></ul>	<ul style="list-style-type: none"><li>• Pop popcorn in regular brown bags or glass bowls.</li><li>• Exceed maximum time on popcorn package.</li></ul>
<b>Baby food</b>	<ul style="list-style-type: none"><li>• Transfer baby food to small dish and heat carefully, stirring often. Check temperature before serving.</li><li>• Put nipples on bottles after heating and shake thoroughly. "Wrist" test before feeding.</li></ul>	<ul style="list-style-type: none"><li>• Heat disposable bottles.</li><li>• Heat bottles with nipples on.</li><li>• Heat baby food in original jars.</li></ul>
<b>General</b>	<ul style="list-style-type: none"><li>• Cut baked goods with filling after heating to release steam and avoid burns.</li><li>• Stir liquids briskly before and after heating to avoid "eruption".</li><li>• Use deep bowl, when cooking liquids or cereals, to prevent boilovers.</li></ul>	<ul style="list-style-type: none"><li>• Heat or cook in closed glass jars or air tight containers.</li><li>• Can in the microwave as harmful bacteria may not be destroyed.</li><li>• Deep fat fry.</li><li>• Dry wood, gourds, herbs or wet papers.</li></ul>

## ABOUT UTENSILS AND COVERINGS

It is not necessary to buy all new cookware. Many pieces already in your kitchen can be used successfully in your new microwave oven. Make sure the utensil does not touch the interior walls during cooking.

### Use these utensils for safe microwave cooking and reheating:

- glass ceramic (Pyroceram®), such as Corningware®.
- heat-resistant glass (Pyrex®)
- microwave-safe plastics
- paper plates
- microwave-safe pottery, stoneware and porcelain
- browning dish (Do not exceed recommended preheating time. Follow manufacturer's directions.)

### These items can be used for short time reheating of foods that have little fat or sugar in them:

- wood, straw, wicker

### DO NOT USE

- metal pans and bakeware
- dishes with metallic trim
- non-heat-resistant glass
- non-microwave-safe plastics (margarine tubs)
- recycled paper products
- brown paper bags
- food storage bags
- metal twist-ties

Should you wish to check if a dish is safe for microwaving, place the empty dish in the oven and microwave on HIGH for 30 seconds. A dish which

becomes very hot should not be used.

### The following coverings are ideal:

- Paper towels are good for covering foods for reheating and absorbing fat while cooking bacon.
- Wax paper can be used for cooking and reheating.
- Plastic wrap that is specially marked for microwave use can be used for cooking and reheating. DO NOT allow plastic wrap to touch food. Vent so steam can escape.
- Lids that are microwave-safe are a good choice because heat is kept near the food to hasten cooking.
- Oven cooking bags are good for large meats or foods that need tenderizing. DO NOT use metal twist ties. Remember to slit bag so steam can escape.

### How to use aluminum foil in your microwave oven:

- Small flat pieces of aluminum foil placed smoothly on the food can be used to shield areas that are either defrosting or cooking too quickly.
- Foil should not come closer than one inch to any surface of the oven.

Should you have questions about utensils or coverings, check a good microwave cookbook or follow recipe suggestions.

**ACCESSORIES** There are many microwave accessories available for purchase. Evaluate carefully before you purchase so that they meet your needs. A microwave-safe thermometer will assist you in determining correct doneness and assure you that foods have been cooked to safe temperatures. Sharp is not responsible for any damage to the oven when accessories are used.

## ABOUT CHILDREN AND THE MICROWAVE

Children below the age of 7 should use the microwave oven with a supervising person very near to them. Between the ages of 7 and 12, the supervising person should be in the same room.

The child must be able to reach the oven comfortably; if not, he/she should stand on a sturdy stool.

At no time should anyone be allowed to lean or swing on the oven door.

Children should be taught all safety precautions: use potholders, remove coverings carefully, pay special attention to packages that crisp food because they may be extra hot.

Don't assume that because a child has mastered one cooking skill he/she can cook everything.

Children need to learn that the microwave oven is not a toy. See page 25 for Child Lock feature.

# INFORMATION YOU NEED TO KNOW

## ABOUT MICROWAVE COOKING

- Arrange food carefully. Place thickest areas towards outside of dish.
- Watch cooking time. Cook for the shortest amount of time indicated and add more as needed. Food severely overcooked can smoke or ignite.
- Cover foods while cooking. Check recipe or cookbook for suggestions: paper towels, wax paper, microwave plastic wrap or a lid. Covers prevent spattering and help foods to cook evenly.
- Shield with small flat pieces of aluminum foil any thin areas of meat or poultry to prevent overcooking before dense, thick areas are cooked thoroughly.
- Stir foods from outside to center of dish once or twice during cooking, if possible.
- Turn foods over once during microwaving to speed cooking of such foods as chicken and hamburgers. Large items like roasts must be turned over at least once.
- Rearrange foods such as meatballs halfway through cooking both from top to bottom and from the center of the dish to the outside.
- Add standing time. Remove food from oven and stir, if possible. Cover for standing time which allows the food to finish cooking without overcooking.
- Check for doneness. Look for signs indicating that cooking temperatures have been reached.

### Doneness signs include:

- Food steams throughout, not just at edge.
- Center bottom of dish is very hot to the touch.
- Poultry thigh joints move easily.
- Meat and poultry show no pinkness.
- Fish is opaque and flakes easily with a fork.

## ABOUT SAFETY

- Check foods to see that they are cooked to the United States Department of Agriculture's recommended temperatures.
- ALWAYS use potholders to prevent burns when handling utensils that are in contact with hot food. Enough heat from the food can transfer through utensils to cause skin burns.
- Avoid steam burns by directing steam away from the face and hands. Slowly lift the farthest edge of a dish's covering and carefully open popcorn and oven cooking bags away from the face.
- Stay near the oven while it's in use and check cooking progress frequently so that there is no chance of overcooking food.
- NEVER use the cavity for storing cookbooks or other items.
- Select, store and handle food carefully to preserve its high quality and minimize the spread of foodborne bacteria.
- Keep waveguide cover clean. Food residue can cause arcing and/or fires.
- Use care when removing items from the oven so that the utensil, your clothes or accessories do not touch the safety door latches.

TEMP	FOOD
160°F	... for fresh pork, ground meat, boneless white poultry, fish, seafood, egg dishes and frozen prepared food.
165°F	... for leftover, ready-to-reheat refrigerated, and deli and carry-out "fresh" food.
170°F	... white meat of poultry.
180°F	... dark meat of poultry.

To test for doneness, insert a meat thermometer in a thick or dense area away from fat or bone. NEVER leave the thermometer in the food during cooking, unless it is approved for microwave oven use.

# PART NAMES

FRONT VIEW

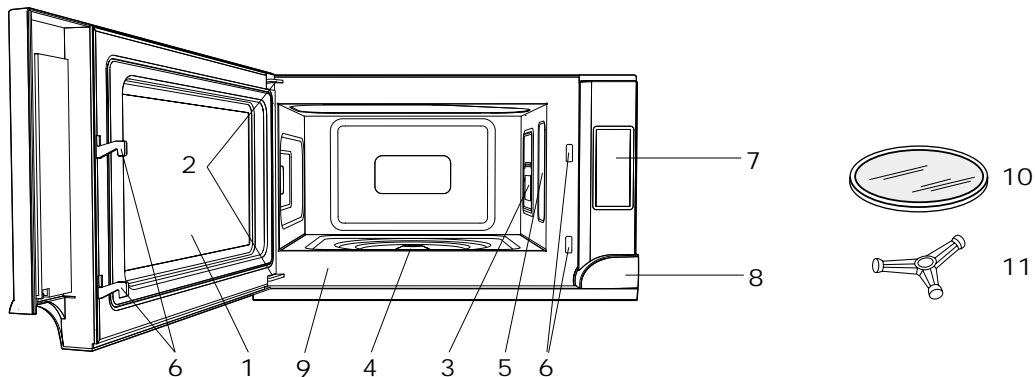

BOTTOM VIEW

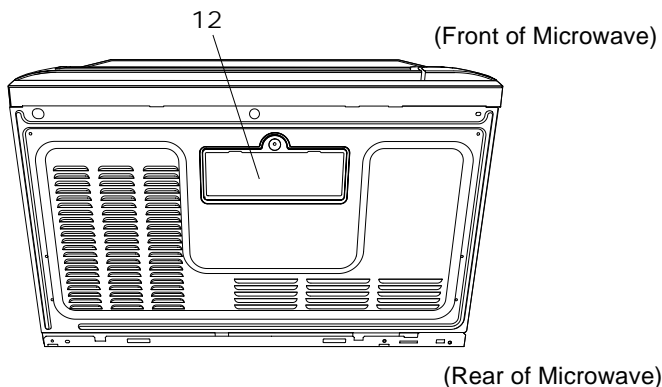

- |   |   |
|---|---|
| <p>1 Oven door with see-through window<br/>Be careful with the edge of the oven door as it is glass and could chip or break.</p> <p>2 Door hinges</p> <p>3 Waveguide cover:<br/>DO NOT REMOVE.</p> <p>4 Turntable motor shaft</p> <p>5 Oven light<br/>It will light when oven is operating or door is open.</p> <p>6 Safety door latches<br/>The oven will not operate unless the door is securely closed.</p> <p>7 Feature Guide Reference Panel</p> | <p>8 One touch DOOR OPEN button<br/>Push to open door.</p> <p>9 Nameplate</p> <p>10 Removable turntable<br/>The turntable will rotate clockwise or counter-clockwise. Only remove for cleaning.</p> <p>11 Removable turntable support<br/>First, carefully place the turntable support in the motor shaft in the center of the oven floor. Then, place the turntable on the turntable support securely.</p> <p>12 Light cover</p> |
|---|---|

## CONTROL PANEL

Words in the lower portion of the display will indicate what function is in progress.

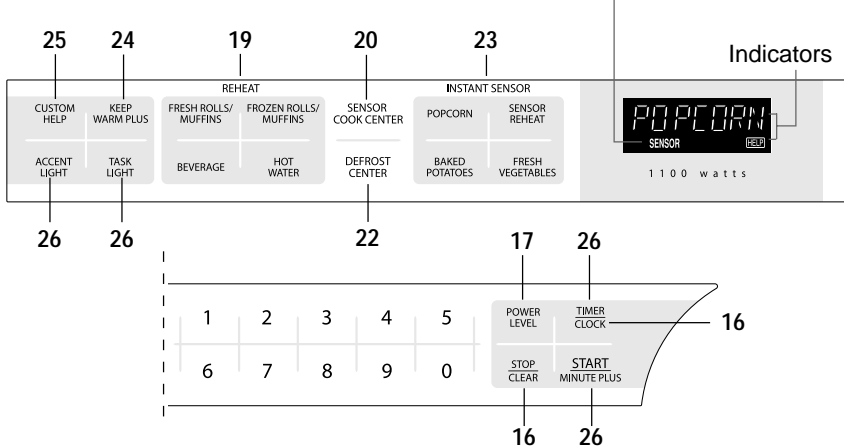

Number indicates pages on which there are feature descriptions and usage information.

## BEFORE OPERATING

- Before operating your new microwave oven make sure you read and understand this operation manual completely.
- Before the oven can be used, follow these procedures:
  1. Plug in the oven. Close the door. The oven display will show **SHARP** **SIMPLY** **THE** **BEST** **PRESS** **CLEAR** **AND** **PRESS** **CLOCK**.
  2. Touch the **STOP/CLEAR** pad. **12:30** will appear.
  3. Set clock.

This is a 12 hour clock. If you attempt to enter an incorrect clock time, **ERROR** will appear in the display. Touch the **STOP/CLEAR** pad and re-enter the time.

- If the electrical power supply to your microwave oven should be interrupted, the display will intermittently show **SHARP** **SIMPLY** **THE** **BEST** **PRESS** **CLEAR** **AND** **PRESS** **CLOCK** after the power is reinstated. If this occurs during cooking, the program will be erased. The time of day will also be erased. Simply touch **STOP/CLEAR** pad and reset the clock for the correct time of day.

## TO SET THE CLOCK

- Suppose you want to enter the correct time of day 12:30 (A.M. or P.M.).

PROCEDURE	DISPLAY
1 <b>TIMER CLOCK</b> 2 Touch <b>CLOCK</b> pad and number 2.	<b>ENTER</b> <b>TIME</b>
2 1 2 3 0 Enter the correct time of day by touching the numbers in sequence.	<b>12.30</b>
3 <b>TIMER CLOCK</b> Touch <b>CLOCK</b> pad again.	<b>12.30</b>

## STOP/CLEAR

Touch the **STOP/CLEAR** pad to:

1. Erase if you make a mistake during programming.
2. Cancel timer.
3. Stop the oven temporarily during cooking.
4. Return the time of day to the display.
5. Cancel a program during cooking, touch twice.



# MANUAL OPERATION

## TIME COOKING

Your oven can be programmed for 99 minutes 99 seconds (99.99). Always enter the seconds after the minutes, even if they are both zeros.

- Suppose you want to cook for 5 minutes at 100%.

PROCEDURE	DISPLAY
1 [5] [0] [0] Enter cooking time.	5.00
2 <b>START</b> <b>MINUTE PLUS</b> Touch <b>START/MINUTE PLUS</b> pad.	5.00 <small>COOK</small>

## TO SET POWER LEVEL

There are eleven preset power levels.

Using lower power levels increases the cooking time which is recommended for foods such as cheese, milk and long slow cooking of meats. Consult cookbook or recipes for specific recommendations.

TOUCH POWER LEVEL PAD NUMBER OF TIMES FOR DESIRED POWER	APPROXIMATE PERCENTAGE OF POWER	COMMON WORDS FOR POWER LEVELS
POWER LEVEL x 1	100%	High
POWER LEVEL x 2	90%	
POWER LEVEL x 3	80%	
POWER LEVEL x 4	70%	Medium High
POWER LEVEL x 5	60%	
POWER LEVEL x 6	50%	Medium
POWER LEVEL x 7	40%	
POWER LEVEL x 8	30%	Med Low/Defrost
POWER LEVEL x 9	20%	
POWER LEVEL x 10	10%	Low
POWER LEVEL x 11	0%	

- Suppose you want to defrost for 5 minutes at 30%.

PROCEDURE	DISPLAY
1 [5] [0] [0] Enter defrosting time.	5.00
2 <b>POWER LEVEL</b> x 8 Touch <b>POWER LEVEL</b> pad eight times or hold down until the desired power level appears.	P-30
3 <b>START</b> <b>MINUTE PLUS</b> Touch <b>START/MINUTE PLUS</b> pad.	5.00 <small>COOK</small>
4 When the defrost time is complete, a long tone will sound and <b>END</b> will appear in the display.	

## MANUAL DEFROST

If the food that you wish to defrost is not listed on the DEFROST CENTER CHART or is above or below the limits in the "Amount" column on the DEFROST CENTER CHART (see page 22), you need to defrost manually.

You can defrost any frozen food, either raw or previously cooked, by using Power Level for 30%. Follow the exact 4-step procedure found under TO SET POWER LEVEL. Estimate defrosting time and press **POWER LEVEL** pad eight times for 30% power.

For either raw or previously cooked frozen food the rule of thumb is approximately 4 minutes per pound. For example, defrost 4 minutes for 1 pound of frozen spaghetti sauce.

Always stop the oven periodically to remove or separate the portions that are defrosted. If food is not defrosted at the end of the estimated defrosting time, program the oven in 1 minute increments on Power Level 30% until totally defrosted.

When using plastic containers from the freezer, defrost only long enough to remove from the plastic in order to place in a microwave-safe dish.

# SPECIAL FEATURES

## SENSOR COOK

Sharp's Sensor is a semi-conductor device that detects the vapor (moisture and humidity) emitted from the food as it heats. The sensor adjusts the cooking times and power level for various foods and quantities.

### Using Sensor Settings:

1. After oven is plugged in, wait 2 minutes before using Sensor Cook.
2. Be sure the exterior of the cooking container and the interior of the oven are dry. Wipe off any moisture with a dry cloth or paper towel.
3. The oven works with foods at normal storage temperature. For example, popcorn would be at room temperature.
4. Any Sensor Cook selection can be programmed with More or Less Time Adjustment. See page 26.
5. More or less food than the quantity listed in the chart should be cooked following the guidelines in any microwave cookbook.
6. During the first part of Sensor Cook, the food name will appear on the display. Do not open the oven door or touch **STOP/CLEAR** during this part of the cooking cycle. The measurement of vapor will be interrupted. If this occurs, an error message will appear. To continue cooking, touch the **STOP/CLEAR** pad and cook manually.

When the sensor detects the vapor emitted from the food, remainder of cooking time will appear. Door may be opened when remaining cooking time appears on the display. At this time, you may stir or season food, as desired.

7. If the sensor does not detect vapor properly when popping popcorn, the oven will turn off, and the correct time of day will be displayed. If the sensor does not detect vapor properly when cooking other foods, **ERROR** will be displayed, and the oven will turn off.
8. Check food for temperature after cooking. If additional time is needed, continue to cook manually.
9. Each food has a cooking hint. Touch **CUSTOM HELP** pad when the HELP indicator is lighted in the display.

### Covering Foods:

Some foods work best when covered. Use the cover recommended in the INSTANT SENSOR and SENSOR COOK CENTER for these foods.

1. Casserole lid.
2. Plastic wrap: Use plastic wrap recommended for microwave cooking. Cover dish loosely; allow approximately 1/2 inch to remain uncovered to allow steam to escape. Plastic wrap should not touch food.
3. Wax paper: Cover dish completely; fold excess wrap under dish to secure. If dish is wider than paper, overlap two pieces at least one inch to cover.

Be careful when removing any covering to allow steam to escape away from you.

# SPECIAL FEATURES

## REHEAT

Reheat allows you to heat four of your favorite foods by touching just one pad.

- Suppose you want to heat 2 fresh rolls or muffins.

PROCEDURE	DISPLAY
<div style="border: 1px solid black; padding: 5px; display: inline-block;"> <b>FRESH ROLLS/ MUFFINS</b> </div> <span style="margin-left: 10px;">x 2</span>	<div style="border: 1px solid black; padding: 5px; display: inline-block;"> <span style="font-size: 1.5em;">2 PCS</span>  <small>HELP</small> </div>
<p>Select desired setting.            Touch <b>FRESH ROLLS/MUFFINS</b> pad 2 times.            The oven starts automatically.</p>	

### NOTE:

1. To increase quantity, touch chosen pad until number in display is same as desired quantity to cook. Ex: touch **BEVERAGE** three times for 1.5 cups. More or less food than the quantity listed in the chart should be heated following the guidelines in any microwave cookbook.
2. Reheat can be programmed with More or Less Time Adjustment. See page 26.
3. The final result will vary according to the food condition (e.g. initial temperature, shape, quality). Check food for temperature after heating. If additional time is needed, continue to heat manually.
4. To use any Reheat setting, touch pad within 3 minutes after cooking, closing the door or touching the **STOP/CLEAR** pad.

## REHEAT CHART

FOOD	AMOUNT	PROCEDURE										
FRESH ROLLS/ MUFFINS	1 - 8	Use this pad to warm rolls, muffins, biscuits, bagels etc. Large items should be considered as 2 or 3 regular size. Arrange on plate; cover with paper towel. For refrigerated rolls or muffins, it may be necessary to double the entered amount to ensure the proper serving temperature. For example, enter quantity of 2 for 1 refrigerated muffin.										
FROZEN ROLLS/ MUFFINS	1 - 8	Use this pad to warm rolls, muffins, biscuits, bagels etc. Large items should be considered as 2 or 3 regular size. Arrange on plate; cover with paper towel.										
BEVERAGE	.5 - 2.0 cups	This setting is good for restoring cooled beverage to a better drinking temperature. Stir liquid briskly before and after heating to avoid "eruption". Touch <b>BEVERAGE</b> pad. <table border="1" style="margin-left: auto; margin-right: auto;"> <thead> <tr> <th colspan="2"><b>Press the pad for amount (cups).</b></th> </tr> </thead> <tbody> <tr> <td>Once</td> <td>.5</td> </tr> <tr> <td>Twice</td> <td>1.0</td> </tr> <tr> <td>3 times</td> <td>1.5</td> </tr> <tr> <td>4 times</td> <td>2.0</td> </tr> </tbody> </table>	<b>Press the pad for amount (cups).</b>		Once	.5	Twice	1.0	3 times	1.5	4 times	2.0
<b>Press the pad for amount (cups).</b>												
Once	.5											
Twice	1.0											
3 times	1.5											
4 times	2.0											
HOT WATER	1 - 6 cups	Use this pad to heat water for preparing coffee, tea, bouillon and instant soup as well as heat the water to cook pasta. When preparing individual cups, place instant coffee, tea or bouillon in cup and stir before heating. Allow to stand 20 seconds after heating before stirring and drinking. Stir carefully after removing from the oven. When heating 4 to 6 cups of water, place in large casserole and cover with lid or plastic wrap. When oven signals, add pasta and continue cooking according to package directions. Touch <b>HOT WATER</b> pad once for each cup up to six.										

# SPECIAL FEATURES

## SENSOR COOK CENTER

You can cook many foods by touching the **SENSOR COOK CENTER** pad and the food number. You don't need to calculate cooking time or power level.

- Suppose you want to cook ground meat.

### PROCEDURE

**1** Touch **SENSOR COOK CENTER** pad and number **1**.



**2** Touch **START/ MINUTE PLUS** pad.



When the sensor detects the vapor emitted from the food, remainder of cooking time will appear.

### NOTE:

1. Sensor Cook Center can be programmed with More or Less Time Adjustment. See page 26.
2. The final result will vary according to the food condition (e.g. initial temperature, shape, quality). Check food for temperature after heating. If additional time is needed, continue to heat manually.

## SENSOR COOK CENTER CHART

FOOD	AMOUNT	PROCEDURE															
1. GROUND MEAT	.25 - 2.0 lb	Use this setting to cook ground beef or turkey as patties or in a casserole to be added to other ingredients. Place patties on a microwave-safe rack and cover with wax paper. Place ground meat in a casserole and cover with wax paper or plastic wrap. When oven stops, turn patties over or stir meat in casserole to break up large pieces. Re-cover and touch <b>START/ MINUTE PLUS</b> . After cooking, let stand, covered, for 2 to 3 minutes.															
2. RICE	.5 - 2.0 cups	Place rice into a deep casserole dish and add double quantity of water. Cover with lid or plastic wrap. After cooking, stir, cover and let stand 3 to 5 minutes or until all liquid has been absorbed. <table border="1" style="margin-left: auto; margin-right: auto;"> <thead> <tr> <th>Rice</th> <th>Water</th> <th>Size of casserole dish</th> </tr> </thead> <tbody> <tr> <td>.5 cup</td> <td>1 cup</td> <td>1.5 quart</td> </tr> <tr> <td>1 cup</td> <td>2 cups</td> <td>2 quart</td> </tr> <tr> <td>1.5 cups</td> <td>3 cups</td> <td>2.5 or 3 quart</td> </tr> <tr> <td>2 cups</td> <td>4 cups</td> <td>3 quart or larger</td> </tr> </tbody> </table>	Rice	Water	Size of casserole dish	.5 cup	1 cup	1.5 quart	1 cup	2 cups	2 quart	1.5 cups	3 cups	2.5 or 3 quart	2 cups	4 cups	3 quart or larger
Rice	Water	Size of casserole dish															
.5 cup	1 cup	1.5 quart															
1 cup	2 cups	2 quart															
1.5 cups	3 cups	2.5 or 3 quart															
2 cups	4 cups	3 quart or larger															
3. FISH/SEAFOOD	.25 - 2.0 lb	Arrange in ring around shallow glass dish (roll fillet with edges underneath). Cover with plastic wrap. After cooking, let stand, covered, 3 minutes.															
4. FROZEN ENTREES	6 - 17 oz	Use this setting for frozen, convenience foods. It will give satisfactory results for most brands. You may wish to try several and choose your favorite. Remove package from outer wrapping and follow package directions for covering. After cooking, let stand, covered for 1 to 3 minutes.															
5. CHICKEN BREAST	.25 - 2.0 lb	Cover with vented plastic wrap. Shield with small, flat pieces of aluminum foil any areas that are cooking too rapidly. Re-cover and touch <b>START/ MINUTE PLUS</b> . After cooking, let stand, covered 3 to 5 minutes. Chicken should be 160°F.															
6. FROZEN VEGETABLES	.25 - 1.25 lb	Do not add water. Cover with lid or plastic wrap. After cooking, stir and let stand, covered, for 3 minutes.															

# SPECIAL FEATURES

## SENSOR COOKING RECIPES

### Mexican Seasoned Potatoes

Makes 6 to 8 servings

- |  |                             |
|--|-----------------------------|
| 4 medium baking potatoes (8 ounces each) | 1/2 teaspoon oregano leaves |
| 1/4 cup olive oil                        | 1/4 teaspoon ground cumin   |
| 1 tablespoon instant minced onion        | 1/2 teaspoon salt           |
| 1/2 teaspoon chili powder                |                             |

- 1 Cut each potato lengthwise into 4 equal wedges. Place potato wedges into 10-inch square casserole. Toss potatoes with oil to coat well.
- 2 In small bowl, combine remaining ingredients. Sprinkle over potatoes.
- 3 Cover potatoes with wax paper. Microwave using **INSTANT SENSOR BAKED POTATOES** setting. Rearrange potatoes when time appears on display. Let stand, covered, 5 minutes.

### Hearty Turkey Chili

Makes 6 servings

- |                            |  |
|----------------------------|--|
| 1 pound ground turkey      | 1 medium zucchini, cut into 1 inch cubes           |
| 1 large onion, chopped     | 1 28 ounce can of tomatoes                         |
| 2 garlic cloves, minced    | 1/3 cup tomato paste                               |
| 2 tablespoons chili powder | 1 15 1/4 to 19 ounce can red kidney beans, drained |
| 1 tablespoon cumin         | 8 ounces frozen corn, thawed                       |

- 1 In 3-quart casserole, place ground turkey, onion, garlic, chili powder and cumin. Mix thoroughly.
- 2 Cover and microwave using **SENSOR COOK CENTER - 1.GROUND MEAT**. Stir and drain.
- 3 To meat mixture, add zucchini, tomatoes with their liquid, tomato paste, beans and corn. Microwave, covered, using **INSTANT SENSOR REHEAT**.

### Creole Corn

Makes 6 servings

- |   |                                   |
|---|-----------------------------------|
| 2 teaspoons oil                               | 1 teaspoon brown sugar            |
| 1/2 cup chopped celery                        | 1/2 teaspoon onion powder         |
| 1/2 cup chopped green pepper                  | 1/4 teaspoon garlic powder        |
| 16 ounce can tomatoes                         | salt and pepper to taste          |
| 4 ounce can mushroom stem and pieces, drained | 1 package (16 ounces) frozen corn |

- 1 In 2-quart casserole, combine oil, celery, green pepper, tomatoes, mushrooms, sugar, onion powder, garlic powder, salt and pepper.
- 2 Microwave using **INSTANT SENSOR REHEAT**. Set aside.
- 3 In covered, 1-quart casserole, microwave corn using **SENSOR COOK CENTER - 6.FROZEN VEGETABLES**. Drain.
- 4 Combine corn and vegetable-seasoning mixture. Stir and serve immediately.

### Savory Flounder Fillets

Makes 4 servings

- |                               |                          |
|-------------------------------|--------------------------|
| 3/4 cup of corn flake crumbs  | 1/2 teaspoon paprika     |
| 3 tablespoons chopped parsley | 1 pound flounder fillets |
| 2 teaspoons grated lemon peel | 1 egg, slightly beaten   |

- 1 On waxed paper, combine corn flake crumbs, parsley, lemon peel and paprika. Dip fillets in beaten egg, then coat with crumb mixture.
- 2 Place fish in a covered, microwave-safe, baking dish. Microwave using **SENSOR COOK CENTER - 3.FISH/SEAFOOD**.
- 3 Serve with tartar or cocktail sauce or melted cheese.



# SPECIAL FEATURES

## DEFROST CENTER

DEFROST CENTER automatically defrosts all the foods shown in the DEFROST CENTER CHART below.

Round the weight to the nearest tenth of a pound. Touch **DEFROST CENTER** pad and the desired number for food selection. Then enter weight in .1 lb increments.

- Suppose you want to defrost a 3.0 pound steak.

PROCEDURE	DISPLAY
<p>1 Touch <b>DEFROST CENTER</b> pad and press number <b>2</b> for STEAKS/CHOPS. Enter weight 3.0 lb. Touch <b>START/MINUTE PLUS</b> pad.</p> <p>The oven will stop and directions will be displayed.</p>	
<p>2 After the 1st stage, open the door, turn steak over and shield any warm portions. Close the door.</p> <p>Touch <b>START/MINUTE PLUS</b> pad.</p>	

- 3 After the 2nd stage, open the door and shield any warm portions. Close the door.

**START  
MINUTE PLUS**

Touch **START/MINUTE PLUS** pad.

- 4 After defrost cycle ends, cover and let stand as indicated in chart below.

### NOTE:

1. Any Defrost Center choice can be programmed with More or Less Time Adjustment. Touch the **POWER LEVEL** pad once or twice after selecting the amount. See page 26.
2. To defrost other foods or foods above or below the weights allowed on the DEFROST CENTER CHART, use time and 30% power. See MANUAL DEFROST on page 17.

If you attempt to enter more or less than the allowed amount as indicated in the chart below, **ERROR** will appear in the display.

## DEFROST CENTER CHART

AMOUNT		PROCEDURE
1. GROUND MEAT	.5 - 2.0 lb	Pull apart and remove any thawed pieces after each stage. Let stand, covered, for 5 to 10 minutes.
2. STEAKS/CHOPS	.5 - 3.0 lb	After each stage, rearrange and if there are warm or thawed portions, shield with small flat pieces of aluminum foil. Remove any meat or fish that is nearly defrosted. Let stand, covered, for 10 to 20 minutes.
3. BONELESS POULTRY	.5 - 2.0 lb	Use boneless breast of chicken or turkey. After each stage, if there are warm or thawed portions, rearrange or remove. Let stand, covered, for 10 to 20 minutes.
4. BONE-IN POULTRY	.5 - 3.0 lb	Arrange pieces with meatiest portions toward outside of glass dish or microwave safe rack. After each stage, if there are warm or thawed portions, rearrange or remove. Let stand, covered, for 10 to 20 minutes.

NOTE: Check foods when oven signals. After final stage, small sections may still be icy. Let stand to continue thawing. Do not defrost until all ice crystals are thawed.

Shielding prevents cooking from occurring before the center of the food is defrosted. Use small smooth strips of aluminum foil to cover edges and thinner sections of the food.

# SPECIAL FEATURES

## INSTANT SENSOR

Instant Sensor allows you to cook or reheat many of your favorite foods by touching just one pad.

- Suppose you want to cook 2 baked potatoes.

### PROCEDURE

Touch **BAKED POTATOES** pad.  
The oven starts automatically.

**BAKED  
POTATOES**

### NOTE:

1. Instant Sensor can be programmed with More or Less Time Adjustment. See page 26.
2. The final result will vary according to the food condition (e.g. initial temperature, shape, quality). Check food for temperature after heating. If additional time is needed, continue to heat manually.
3. To use any Instant Sensor pad, touch pad within 3 minutes after cooking, closing the door or touching the **STOP/CLEAR** pad.

## INSTANT SENSOR CHART

FOOD	AMOUNT	PROCEDURE
REHEAT	4 - 36 oz	Place in dish or casserole slightly larger than amount to be reheated. Flatten, if possible. Cover with lid, plastic wrap or wax paper. Use covers such as plastic wrap or lids with larger quantities of more dense foods such as stews. After reheating, stir well, if possible. Re-cover and allow to stand 2 to 3 minutes. Foods should be very hot. If not, continue to heat with variable power and time.
POPCORN	2.85 - 3.5 oz bag (Regular) 1.5 - 1.75 oz bag (Snack)	Use only popcorn packaged for the microwave. Try several brands to decide which you like. Do not try to pop unpopped kernels. Touch <b>POPCORN</b> pad once for regular size, touch again for snack size.
BAKED POTATOES	1 - 6 med.	Pierce. Place on paper-towel-lined turntable. After cooking, remove from oven, wrap in aluminum foil and let stand 5 to 10 minutes.
FRESH VEGETABLES: Soft		Wash and place in casserole. Add no water if vegetables have just been washed. Cover with lid for tender vegetables. Use plastic wrap for tender-crisp vegetables. Touch <b>FRESH VEGETABLES</b> pad. After cooking, stir, if possible. Let stand, covered, for 2 to 5 minutes.
Broccoli	.25 - 2.0 lb	
Brussels sprouts	.25 - 2.0 lb	
Cabbage	.25 - 2.0 lb	
Caulif. (flowerets)	.25 - 2.0 lb	
Cauliflower (whole)	1 med.	
Spinach	.25 - 1.0 lb	
Zucchini	.25 - 2.0 lb	
Baked apples	2 - 4 med.	
FRESH VEGETABLES: Hard		Place in casserole. Add 1-4 tbsp water. Cover with lid for tender vegetables. Use plastic wrap cover for tender-crisp vegetables. Touch <b>FRESH VEGETABLES</b> pad twice. After cooking, stir, if possible. Let stand, covered, for 2 to 5 minutes.
Carrots, sliced	.25 - 1.5 lb	
Corn on the cob	2 - 4	
Green beans	.25 - 1.5 lb	
Winter squash:		
diced	.25 - 1.5 lb	
halves	1 - 2	

# SPECIAL FEATURES

## KEEP WARM PLUS

Keep Warm Plus allows you to keep food warm for 30 minutes.

### DIRECT USE

- Suppose you want to keep a cup of soup warm for 30 minutes.

#### PROCEDURE

1 Touch **KEEP WARM PLUS** pad. 

2 Enter the desired time. 

3 Touch **START/MINUTE PLUS** pad. 

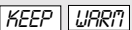
The oven will start. The display will show  and count down.  will be displayed during the countdown.

You can program Keep Warm Plus with manual cooking to keep food warm continuously after cooking.

## WITH MANUAL COOKING

- Suppose you want to cook a cup of soup for 2 minutes at 70% and keep the soup warm for 15 minutes.

#### PROCEDURE

1 Enter cooking time. 

2 Touch **POWER LEVEL** pad 4 times for 70% power. 

3 Touch **KEEP WARM PLUS** pad. 

4 Enter the desired time. 

5 Touch **START/MINUTE PLUS** pad. 

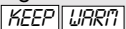
The operation will start. When the cooking time is complete, a long tone will sound and Keep Warm Plus will start.  will appear in the display every 10 seconds and count down for 15 minutes.

NOTE: Keep Warm Plus cannot be programmed with special features.



# OTHER CONVENIENT FEATURES

## CUSTOM HELP

Custom Help provides 4 features that make using your oven easy because specific instructions are provided in the interactive display.

### 1. CHILD LOCK

The Child Lock prevents unwanted oven operation such as by small children. The oven can be set so that the control panel is deactivated or locked. To set, touch **CUSTOM HELP**, the number 1 and then touch the **START/MINUTE PLUS** pad. Should a pad be touched, **CHILD** **LOCK ON** will appear in the display.

To cancel, touch **CUSTOM HELP** and **STOP/CLEAR** pad.

### 2. AUDIBLE SIGNAL ELIMINATION







If you wish to have the oven operate with no audible signals, touch **CUSTOM HELP**, the number 2 and **STOP/CLEAR**.

To cancel and restore the audible signal, touch **CUSTOM HELP**, the number 2 and **START/MINUTE PLUS**.

### 3. AUTO START

If you wish to program your oven to begin cooking automatically at a designated time of day, follow this procedure:

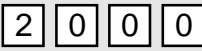
- Suppose you want to start cooking a stew for 20 minutes on 50% at 4:30. Before setting, check to make sure the clock is showing the correct time of day.

PROCEDURE	
1	Touch <b>CUSTOM HELP</b> pad. 
2	Touch number 3. 
3	Enter the start time. 
4	Touch <b>CLOCK</b> pad. 
5	Enter cooking program.  
6	Touch <b>START/MINUTE PLUS</b> pad. 

NOTE:

- Auto Start can be used for manual cooking if clock is set.

- If the oven door is opened after programming Auto Start, it is necessary to touch the **START** pad for Auto Start time to appear in the readout so that the oven will automatically begin programmed cooking at the chosen Auto Start time.
- Be sure to choose foods that can be left in the oven safely until the Auto Start time. Acorn or butternut squash are often a good choice.
- If you wish to know the time of day, simply touch the **CLOCK** pad. As long as your finger is touching the **CLOCK** pad, the time of day will be displayed.

### 4. LANGUAGE / WEIGHT SELECTION

The oven comes set for English and U.S. Customary Unit-pounds. To change, touch **CUSTOM HELP** and the number 4. Continue to touch the number 4 until your choice is selected from the table below. Then, touch **START**.

Touch number 4 for language and standard of weight.

NUMBER	LANGUAGE	STANDARD OF WEIGHT	DISPLAY
Once	English	LBS	ENGLISH Lb
Twice	English	KG	ENGLISH KG
3 times	Spanish	LBS	ESPAÑOL Lb
4 times	Spanish	KG	ESPAÑOL KG
5 times	French	LBS	FRANC. Lb
6 times	French	KG	FRANC. KG

## DEMONSTRATION MODE

To demonstrate, touch **TIMER/CLOCK**, the number 0 and then touch the **START** pad and hold for three seconds. **DEMO ON** will appear in the display. Cooking operations and specific special features can now be demonstrated with no power in the oven. For example, touch **MINUTE PLUS** pad and the display will show **1:00** and count down quickly to **END**.

To cancel, touch **TIMER/CLOCK**, the number 0 and **STOP/CLEAR** pads. If easier, unplug the oven from the electrical outlet and replug.

## HELP

Each setting of INSTANT SENSOR, SENSOR COOK CENTER, REHEAT and DEFROST CENTER has a cooking hint. If you wish to check, touch **CUSTOM HELP** whenever HELP is lighted in the Interactive Display for these and other manual operation hints.

## OTHER CONVENIENT FEATURES

### MULTIPLE SEQUENCE COOKING

Your oven can be programmed for up to 4 automatic cooking sequences, switching from one power level setting to another automatically.

Sometimes cooking directions tell you to start on one power level and then change to a different power level. Your oven can do this automatically.

- Suppose you want to cook roast beef for 5 minutes at 100% and then continue to cook for 30 minutes at 50%.

PROCEDURE							
1	First enter cooking time. Then touch <b>POWER LEVEL</b> once for 100% power.						
	<table border="1"> <tr> <td>5</td> <td>0</td> <td>0</td> </tr> </table> <table border="1"> <tr> <td>POWER LEVEL</td> <td>x 1</td> </tr> </table>	5	0	0	POWER LEVEL	x 1	
5	0	0					
POWER LEVEL	x 1						
2	Then enter second cooking time. Touch <b>POWER LEVEL</b> pad 6 times for 50% power.						
	<table border="1"> <tr> <td>3</td> <td>0</td> <td>0</td> <td>0</td> </tr> </table> <table border="1"> <tr> <td>POWER LEVEL</td> <td>x 6</td> </tr> </table>	3	0	0	0	POWER LEVEL	x 6
3	0	0	0				
POWER LEVEL	x 6						
3	Touch <b>START/MINUTE PLUS</b> pad.						
	<table border="1"> <tr> <td>START</td> <td>MINUTE PLUS</td> </tr> </table>	START	MINUTE PLUS				
START	MINUTE PLUS						

NOTE:

1. If **POWER LEVEL** pad is touched, 

P-HI
------

 will be displayed.
2. If 100% is selected as the final sequence, it is not necessary to touch the **POWER LEVEL** pad.
3. Keep Warm Plus can be programmed even if 4 cooking sequences have been set.

### MINUTE PLUS

Minute Plus allows you to cook for a minute at 100% by simply touching the **START/MINUTE PLUS** pad. You can also extend cooking time in multiples of 1 minute by repeatedly touching the **START/MINUTE PLUS** pad during manual cooking.

- Suppose you want to heat a cup of soup for one minute.

PROCEDURE			
Touch <b>START/MINUTE PLUS</b> pad.	<table border="1"> <tr> <td>START</td> <td>MINUTE PLUS</td> </tr> </table>	START	MINUTE PLUS
START	MINUTE PLUS		

NOTE:

1. To use Minute Plus, touch pad within 3 minutes after cooking, closing the door, touching the **STOP/CLEAR** pad.
2. Minute Plus cannot be used with special features.

### MORE OR LESS TIME ADJUSTMENT

Should you discover that you like any of the Cook Center, Defrost Center, Reheat, Popcorn or Hot Water settings slightly **more** done, touch the **POWER LEVEL** pad **once** after touching your choice of pads or before touching **START** pad. The display will show 

MORE
------

.

Should you discover that you like any of the Cook Center, Defrost Center, Reheat, Popcorn or Hot Water settings slightly **less** done, touch the **POWER LEVEL** pad **twice** after touching your choice of pads or before touching **START** pad. The display will show 

LESS
------

.

### TIMER

- Suppose you want to time a 3-minute long distance phone call.

PROCEDURE				
1	Touch <b>TIMER/CLOCK</b> and number 1 pad.			
	<table border="1"> <tr> <td>TIMER</td> <td>CLOCK</td> <td>1</td> </tr> </table>	TIMER	CLOCK	1
TIMER	CLOCK	1		
2	Enter time.			
	<table border="1"> <tr> <td>3</td> <td>0</td> <td>0</td> </tr> </table>	3	0	0
3	0	0		
3	Touch <b>TIMER/CLOCK</b> pad.			
	<table border="1"> <tr> <td>TIMER</td> <td>CLOCK</td> </tr> </table>	TIMER	CLOCK	
TIMER	CLOCK			
To cancel the timer, touch the <b>STOP/CLEAR</b> pad once.				
	<table border="1"> <tr> <td>STOP</td> <td>CLEAR</td> </tr> </table>	STOP	CLEAR	
STOP	CLEAR			

### ACCENT LIGHT AND TASK LIGHT

To operate the Accent Light and Task Light, follow the procedures in the chart below:

PROCEDURE	DISPLAY
Touch ACCENT LIGHT once	Accent light on (LOW)
Touch ACCENT LIGHT twice	OFF
Touch ACCENT LIGHT 3 times	Accent light on (LOW)
Touch TASK LIGHT once	Task light on (HIGH)
Touch TASK LIGHT twice	OFF
Touch TASK LIGHT 3 times	Task light on (HIGH)
Touch ACCENT LIGHT once	Accent light on (LOW)
Touch TASK LIGHT once	Task light on (HIGH)
Touch TASK LIGHT twice	OFF

# CLEANING AND CARE

Disconnect the power cord before cleaning or leave the door open to inactivate the oven during cleaning.

## Exterior

The outside surface is precoated steel and plastic. Clean the outside with mild soap and water; rinse and dry with a soft cloth. Do not use any type of household or abrasive cleaner.

## Door

Be careful with the edge of the oven door as it is glass and could chip or break. Wipe the window on both sides with a damp cloth to remove any spills or splatters. Metal parts will be easier to maintain if wiped frequently with a damp cloth. Avoid the use of spray and other harsh cleaners as they may stain, streak or dull the door surface.

## Touch Control Panel

Wipe the panel with a cloth dampened slightly with water only. Dry with a soft cloth. Do not scrub or use any sort of chemical cleaners. Close door and touch **STOP/CLEAR**.

## Interior

Cleaning is easy because little heat is generated to the interior surfaces; therefore, there is no baking and setting of spills or spattering. To clean the interior surfaces, wipe with a soft cloth and warm water. **DO NOT USE ABRASIVE OR HARSH CLEANERS OR SCOURING PADS.** For heavier soil, use baking soda or a mild soap; rinse thoroughly with hot water. The rack can be cleaned with hot soapy water, rinsed and dried.

## Odor Removal

Occasionally, a cooking odor may remain in the oven. To remove, combine 1 cup water, grated peel and juice of 1 lemon and several whole cloves in a 2-cup glass measuring cup. Boil for several minutes using 100% power. Allow to set in oven until cool. Wipe interior with a soft cloth.

## Turntable/Turntable Support

The turntable and turntable support can be removed for easy cleaning. Wash them in mild, sudsy water; for stubborn stains use a mild cleanser and non-abrasive scouring sponge. They are also dishwasher-proof. Use upper rack of dishwasher. The turntable motor shaft is not sealed, so excess water or spills should be wiped up immediately.

## Waveguide Cover

The waveguide cover is located on the right side wall of the oven cavity. It is made from mica so requires special care. Keep the waveguide cover clean to assure good oven performance. Carefully wipe with a damp cloth any food splatters from the surface of the cover immediately after they occur. Built-up splashes may overheat and cause smoke or possibly catch fire. **DO NOT REMOVE THE WAVEGUIDE COVER.**

# REPLACING PARTS

## ACCENT LIGHT AND TASK LIGHT

1. To replace light bulbs, first disconnect power to the oven at the circuit breaker panel or by unplugging.
2. To release cover, remove the screw on the light cover. (See illustration.)
3. Replace light bulbs with equivalent watt bulb available from your Sharp Authorized Servicer or parts distributor. Bulbs are also available at most hardware stores or lighting centers. **DO NOT USE A BULB LARGER THAN 30 WATTS.**
4. Close light cover and secure with screw removed in step 2.

**CAUTION:** Light cover may become very hot. Do not touch glass when light is on.

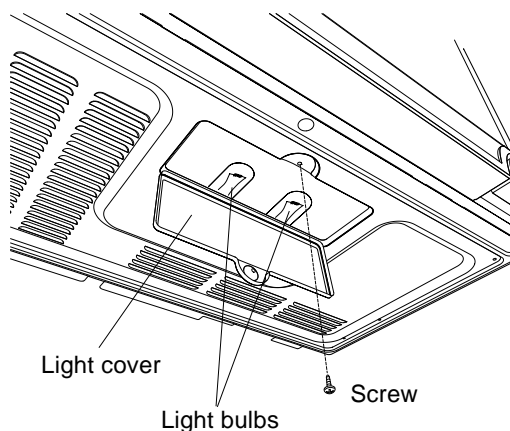

# SERVICE CALL CHECK

Please check the following before calling for service:

Place one cup of water in a glass measuring cup in the oven and close the door securely.  
Operate the oven for one minute at HIGH 100%.

- A Does the oven light come on? YES \_\_\_\_\_ NO \_\_\_\_\_
- B Does the cooling fan work? YES \_\_\_\_\_ NO \_\_\_\_\_  
(Put your hand over the bottom ventilation openings.)
- C Does the turntable rotate? YES \_\_\_\_\_ NO \_\_\_\_\_  
(It is normal for the turntable to turn in either direction.)
- D Is the water in the oven warm? YES \_\_\_\_\_ NO \_\_\_\_\_

If “NO” is the answer to any of the above questions, please check electrical outlet, fuse and/or circuit breaker. If they are functioning properly, CONTACT YOUR NEAREST SHARP AUTHORIZED SERVICER. A microwave oven should never be serviced by a “do-it-yourself” repair person.

NOTE: If time appearing in the display is counting down very rapidly, check Demonstration Mode on page 25 and cancel.

# SPECIFICATIONS

R-1210, R-1211

AC Line Voltage:	Single phase 120V, 60Hz, AC only
AC Power Required:	1530 watts, 13.0 amps.
Output Power:	1100 watts*
Frequency:	2450 MHz
Outside Dimensions:	23 7/8"(W) x 14 1/16"(H) x 15 9/16"(D)
Cavity Dimensions:	17 1/2"(W) x 9 7/8"(H) x 14 15/16"(D)
Oven Capacity:	1.5 Cu. Ft.
Cooking Uniformity:	Turntable system
Weight:	Approx. 55 lb

★ The International Electrotechnical Commission’s standardized method for measuring output wattage. This test method is widely recognized.

In compliance with standards set by:

- FCC** – Federal Communications Commission Authorized.
- DHHS** – Complies with Department of Health and Human Services (DHHS) rule, CFR, Title 21, Chapter I, Subchapter J.



– This symbol on the nameplate means the product is listed by Underwriters Laboratories, Inc.

# THE ULTIMATE ACCESSORY

- ✦ Great recipes
- ✦ Reliable microwave reference guide
- ✦ Many color photos
- ✦ Step-by-step instructions
- ✦ Nutritional information for each recipe
- ✦ Durable wipe-clean soft cover with 128 8 1/2 x 11 pages
- ✦ Helpful tips and special techniques

## SHARP®

### CAROUSEL MICROWAVE COOKBOOK

#### TO ORDER

Simply call this toll-free number : **1-800-642-2122**. Please have your credit card ready.

If you prefer to order by mail, complete and return the order form below. Please include check or money order (payable to Sharp Accessories & Supplies Center) for \$6.00 plus \$4.25 shipping & handling and tax, if applicable, per book.

#### SATISFACTION GUARANTEED

You must be completely satisfied with the Sharp Carousel Microwave Cookbook. If, within 14 days, you are dissatisfied for any reason, simply return the book and we'll gladly refund your \$6.00 plus tax.

(SOLAMENTE ESCRITO EN INGLES!)

Cut along this line.

## COOKBOOK ORDER FORM

Please send me \_\_\_\_\_ cookbooks at \$10.25 each \$ \_\_\_\_\_

Illinois sales tax, (if applicable) per book \$.44 no. of books \_\_\_\_\_ \$ \_\_\_\_\_

Other tax, (if applicable) no. of books \_\_\_\_\_ \$ \_\_\_\_\_

**TOTAL ORDER AMOUNT \$ \_\_\_\_\_**

I have enclosed a check made payable to Sharp Accessories & Supplies Center.

Please bill my  VISA  MASTERCARD  AMERICAN EXPRESS

Acct. No. \_\_\_\_\_ Expiration date \_\_\_\_ / \_\_\_\_

Signature \_\_\_\_\_

(All credit card orders must be signed.)

Name \_\_\_\_\_

Address \_\_\_\_\_

City \_\_\_\_\_ State \_\_\_\_\_ Zip \_\_\_\_\_

Daytime Phone No. ( ) \_\_\_\_\_

Mail to: SHARP Accessories & Supplies Center  
2130 Townline Road  
Peoria, Illinois 61615-1560

Price is subject to change without notice.

# GUIA AUTO-TOUCH

Para mayor información y precauciones de seguridad, consulte el Manual de Operaciones.

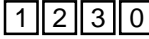
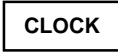

## PONER LA HORA

Si en la pantalla se lee *SHARP SIMPLY THE BEST PRESS CLEAR AND PRESS CLOCK* toque primero **STOP/CLEAR**.

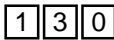

- 1 Toque el botón que dice **CLOCK**  número 2 .
- 2 Ajuste el reloj en la hora correcta oprimiendo los botones numéricos en el orden respectivo. (Ej: 12:30)   

- 3 Toque nuevamente el botón que dice **CLOCK**.

## OPERACION MANUAL

### Cocimiento con Alta Energía

- 1 Marque el tiempo de cocimiento al oprimir los numeros. (Ej: 1 min. 30 sec.)   

- 2 Pulse la tecla **START/ MINUTE PLUS**.

### Energía de Cocimiento Variable

- 1 Después de realizar el primer paso (Num. 1 arriba), oprima el **POWER LEVEL** ocho veces para 30%.  x 8
- 2 Pulse la tecla **START/ MINUTE PLUS**. 

## INSTANT SENSOR

Pulse el botón **BAKED POTATOES**. 



## INSTANT SENSOR TABLA

TIPO DE COMIDA	CANTIDAD
SENSOR REHEAT	4 a 36 onzas
POPCORN	Bolsa de 2,85 a 3,5 onzas Bolsa de 1,5 a 1,75 onzas
BAKED POTATOES	1 a 6 med.
FRESH VEGETABLES	
Suave	0,25 a 2,0 libras
Firme	0,25 a 1,5 libras



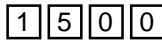

## MINUTE PLUS

Oprima **START/MINUTE PLUS** para obtener un minuto al 100% de energía o para agregar otro minuto durante el cocimiento manual. Vuelva a oprimirlo para obtener minutos adicionales. 

## KEEP WARM PLUS

- 1 Pulse la tecla **KEEP WARM PLUS**. 
- 2 Introduzca un tiempo de 15 minutos. 
- 3 Pulse la tecla **START/ MINUTE PLUS**. 

## DEFROST CENTER

- 1 Pulse la tecla **DEFROST CENTER** y el numero 2 para Bistec/Costillas. 
- 2 Introduzca el peso de 3.0 lb. Pulse la tecla **START/ MINUTE PLUS**.   
El horno se detendrá automáticamente y en la pantalla podrá observar diversas indicaciones. Siga los mensajes indicados. 
- 3 Después de concluir la 1ra etapa, abra la puerta y levante el bistec, limpie el agua, coloque nuevamente el bistec. Cierre la puerta. Pulse la tecla **START/MINUTE PLUS**. 
- 4 Después de la 2da etapa, abra la puerta y repita el proceso del paso 2. Cierre la puerta. Pulse la tecla **START/MINUTE PLUS**. 
- 5 Después que el ciclo de descongelamiento concluya, deje reposar el alimento.

## DEFROST CENTER TABLA

TIPO DE COMIDA	CANTIDAD
1. GROUND MEAT	0,5 a 2,0 libras
2. STEAKS/CHOPS	0,5 a 3,0 libras
3. BONELESS POULTRY	0,5 a 2,0 libras
4. BONE-IN POULTRY	0,5 a 3,0 libras

Carousel® es una marca registrada de Sharp Corporation.

# AUTO-TOUCH GUIDE

Continued from back cover.

## SENSOR COOK CENTER

1 Touch **SENSOR COOK CENTER** pad and number 1 for ground meat.

**SENSOR COOK CENTER**

1

2 Touch **START/ MINUTE PLUS** pad.

**START MINUTE PLUS**

## SENSOR COOK CENTER CHART

FOOD	AMOUNT
1. GROUND MEAT	.25 - 2.0 lb
2. RICE	.5 - 2.0 cups
3. FISH/SEAFOOD	.25 - 2.0 lb
4. FROZEN ENTREES	6 - 17 oz
5. CHICKEN BREAST	.25 - 2.0 lb
6. FROZEN VEGETABLES	.25 - 1.25 lb

## REHEAT

Touch **FRESH ROLLS & MUFFINS** pad 2 times to heat 2 fresh rolls or muffins. The oven starts automatically.

**FRESH ROLLS & MUFFINS**

x 2

## REHEAT CHART

FOOD	AMOUNT
FRESH ROLLS/MUFFINS	1 - 8
FROZEN ROLLS/MUFFINS	1 - 8
BEVERAGE	.5 - 2.0 cups
HOT WATER	1 - 6 cups

# GUIA AUTO-TOUCH

Continuado de la página 30.

## SENSOR COOK CENTER

1 Pulse la tecla **SENSOR COOK CENTER** y el numero 1 para albondigas.

**SENSOR COOK CENTER**

1

2 Pulse la tecla **START/ MINUTE PLUS**.

**START MINUTE PLUS**

## SENSOR COOK CENTER TABLA

TIPO DE COMIDA	CANTIDAD
1. GROUND MEAT	0,25 a 2,0 libras
2. RICE	0,5 a 2,0 tazas
3. FISH/SEAFOOD	0,25 a 2,0 libras
4. FROZEN ENTREES	6 a 17 onzas
5. CHICKEN BREAST	0,25 a 2,0 libras
6. FROZEN VEGETABLES	0,25 a 1,25 libras

## REHEAT

Pulse la tecla **FRESH ROLLS & MUFFINS** 2 veces para calentar 2 roles o mantecadas frescas. El horno comenzara automaticamente.

**FRESH ROLLS & MUFFINS**

x 2

## REHEAT TABLA



TIPO DE COMIDA	CANTIDAD
FRESH ROLLS/MUFFINS	1 a 8
FROZEN ROLLS/MUFFINS	1 a 8
BEVERAGE	0,5 a 2,0 tazas
HOT WATER	1 a 6 tazas

# AUTO-TOUCH GUIDE

For more complete information and safety precautions, refer to your Operation Manual.

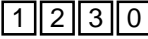

## SET CLOCK

If SHARP SIMPLY THE BEST PRESS CLEAR AND PRESS CLOCK is in the display, first touch **STOP/CLEAR**.



- 1 Touch **TIMER/CLOCK** pad and number 2. 
- 2 Enter correct time of the day by touching numbers in sequence. (Ex: 12:30) 
- 3 Touch **TIMER/CLOCK** pad again. 

## MANUAL OPERATION

### High Power Cooking

- 1 Enter cooking time by touching number pads. (Ex: 1 min. 30 sec.)   

- 2 Touch **START/MINUTE PLUS** pad.

### Variable Power Cooking

- 1 After Step 1 above, touch **POWER LEVEL** pad eight times for 30%.   

- 2 Touch **START/MINUTE PLUS** pad.

## INSTANT SENSOR

Touch **BAKED POTATOES** pad. The oven starts automatically. 





## INSTANT SENSOR CHART

FOOD	AMOUNT
SENSOR REHEAT	4 - 36 oz
POPCORN	2.85 - 3.5 oz bag (reg.) 1.5 - 1.75 oz bag (snack)
BAKED POTATOES	1 - 6 med.
FRESH VEGETABLES	.25 - 2.0 lb (soft) .25 - 1.5 lb (hard)

## MINUTE PLUS

Touch **START/MINUTE PLUS** for one minute at 100% power or to add a minute during manual cooking. Continue to touch for additional minutes. 



## DEFROST CENTER

- 1 Touch **DEFROST CENTER** pad and number 2 for Steaks/Chops. 
- 2 Enter weight 3.0 lb.   
Touch **START/MINUTE PLUS** pad. The oven will stop and directions will be displayed. Follow the indicated message. 
- 3 After the 1st stage, open the door, turn steak over and shield any warm portions. Close the door. Touch **START/MINUTE PLUS** pad. 
- 4 After the 2nd stage, open the door and shield any warm portions. Close the door. Touch **START/MINUTE PLUS** pad. 
- 5 After defrost cycle ends, cover and let stand.

## DEFROST CENTER CHART

FOOD	AMOUNT
1. GROUND MEAT	.5 - 2.0 lb
2. STEAKS/CHOPS	.5 - 3.0 lb
3. BONELESS POULTRY	.5 - 2.0 lb
4. BONE-IN POULTRY	.5 - 3.0 lb

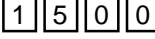
## KEEP WARM PLUS

- 1 Touch **KEEP WARM PLUS** pad. 
- 2 Enter time 15 minutes. 
- 3 Touch **START/MINUTE PLUS** pad. 

Continued on page 31.

Carousel® is a registered trademark of Sharp Corporation.

# SHARP

SHARP ELECTRONICS CORPORATION  
Sharp Plaza, Mahwah, New Jersey 07430-2135



RECYCLED PAPER  
PRINTED IN USA