



INSTRUCTION MANUAL

Microwave Oven

EM-S2587W
EM-S2587V



Read these instructions carefully before use.
If you follow these instructions,
your Microwave Oven will serve you long and well.

TABLE OF CONTENTS

PRECAUTIONS TO AVOID POSSIBLE EXPOSURE TO EXCESSIVE MICROWAVE ENERGY

Specifications	2
----------------	---

IMPORTANT SAFETY INSTRUCTIONS

Warning	3
Safety	3

SAVE THESE INSTRUCTIONS

To reduce the risk of injury to persons	6
Grounding installation	6
Danger	6
Warning	6
Caution	7
Utensils	7
Materials you can use in microwave oven	7
Materials to be avoided in microwave oven	8

SETTING UP YOUR OVEN

Names of oven parts and accessories	8
Turntable installation	9
Countertop installation	9
Installation	9

OPERATION

Control panel and features	10
Operation	11

MAINTENANCE

Troubleshooting	15
-----------------	----

PRECAUTIONS TO AVOID POSSIBLE EXPOSURE TO EXCESSIVE MICROWAVE ENERGY

- (a) Do not attempt to operate this oven with the door open since this can result in harmful exposure to microwave energy. It is important not to break or tamper with the safety interlocks.
- (b) Do not place any object between the oven front face and the door or allow soil or cleaner residue to accumulate on sealing surfaces.
- (c) **Do not operate the oven if it is damaged. It is particularly important that the oven door closes properly and that there is no damage to the:**
 - (1) **DOOR (bent)**
 - (2) **HINGES AND LATCHES (broken or loosened)**
 - (3) **DOOR SEALS AND SEALING SURFACE**
- (d) **The oven should not be adjusted or repaired by anyone except properly qualified service personnel.**

Specifications

Model:	EM-S2587W / EM-S2587V
Power Source:	230-240V~ 50Hz
Power Consumption:	1250W
Output Microwave:	800W 2450MHz
Outside Dimensions (WxDxH):	461x359x280mm
Oven Capacity:	20L
Turntable Diameter:	24.5 cm
Net Weight:	12.2 kg

IMPORTANT SAFETY INSTRUCTIONS

WARNING

To reduce the risk of fire, electric shock, injury to persons or exposure to excessive microwave oven energy when using your appliance, follow basic precautions, including the following:

1. Read all instructions before using the appliance.
2. Read and follow the specific: **"PRECAUTIONS TO AVOID POSSIBLE EXPOSURE TO EXCESSIVE MICROWAVE ENERGY"**
3. As with most cooking appliances, close supervision is necessary to reduce the risk of a fire in the oven cavity.

If materials inside the oven ignite:

1. Keep the oven door closed.
2. Turn the oven off, and unplug the appliance.
3. Disconnect the power cord, shut off power at the fuse or circuit breaker panel.

Safety:

1. The oven must be on a leveled surface.
2. The turntable and turntable roller rest must be in the oven during cooking. Place the cookware gently on the turntable and handle it carefully to avoid possible breakage.
3. Incorrect use of browning dish may cause the turntable to break.
4. The oven has several built-in safety switches to ensure that the power remains off when the door is open. Do not tamper with these switches.
5. Do not operate the microwave oven empty. Operating the oven with no food or food that is extremely low in moisture can cause fire, charring or sparking.
6. Do not cook bacon directly on the turntable. Excessive local heating of the turntable may cause the turntable to break.
7. Do not attempt to deep-fry in your microwave oven.
8. Do not attempt home canning in this microwave oven, as it is impossible to be sure all contents of the jar have reached boiling temperature.
9. Do not use this microwave oven for commercial purpose. This microwave oven is made for household use only.
10. Use carefully when cooking food in the microwave oven to avoid burning due to excessive cooking.
11. Failure to maintain the oven in a clean condition could lead to deterioration that could adversely affect the life of the appliance and possibly result in a hazardous situation.

12. Do not overcook food. Carefully attend the appliance when paper, plastic, or other combustible materials are placed inside the oven to facilitate cooking.
13. Do not use the oven cavity for storage purposes. Do not store combustible items such as bread, cookies, paper products, etc. inside the oven.
14. Remove wire twist-ties and metal handles from paper or plastic containers/bags before placing them in the oven.
15. Plug into a wall receptacle that is properly installed and grounded.
16. Install or locate this oven only in accordance with the installation instructions provided.
17. Some products such as whole eggs, water with oil or fat, sealed to explode and therefore should not be heated in this oven.
18. Use this appliance only for its intended uses as described in this manual. Do not use corrosive chemicals or vapors in this appliance. This oven is specifically designed to heat or cook food. It is not designed for industrial or laboratory use.
19. Do not operate this oven if it has a damaged cord or plug, if it is not working properly or if it has been damaged or dropped.
20. Do not cover or block any vents on the oven.
21. Do not store or use this appliance outdoors.
22. Do not use this oven near water, for example, near a kitchen sink, in a wet basement, near a swimming pool, or similar locations.
23. Do not immerse cord or plug in water.
24. Keep cord away from heated surfaces.
25. Do not let cord hang over edge of table or counter.
26. When cleaning door and oven surfaces use only mild, nonabrasive soaps or detergents applied with a sponge or soft cloth.
27. This appliance is not intended for use by young children or infirm persons unless they have been adequately supervised by a responsible person to ensure that they can use the appliance safely. Young children should be supervised to ensure that they do not play with the appliance.
28. Liquids, such as water, coffee, or tea are able to be overheated beyond the boiling point without appearing to be boiling. Visible bubbling or boiling when the container is removed from the microwave oven is not always present. This could result in very hot liquids suddenly boiling over when the container is disturbed or a spoon or other utensil is inserted into the liquid.
 - i) Do not overheat the liquid.
 - ii) Stir the liquid both before and halfway through heating it.
 - iii) Do not use straight-sided containers with narrow necks.
 - iv) After heating, allow the container to stand in the microwave oven for a short time before removing the container.
 - v) Use extreme care when inserting a spoon or other utensil into the container.
29. Liquids or other food must not be heated in narrow-necked or sealed containers since they are liable to explode.

30. Utensils should be checked to ensure that they are suitable for use in microwave ovens.
31. When heating food in plastic or paper containers, check the oven frequently due to the possibility of ignition.
32. If smoke is observed, switch off or unplug the appliance and keep the door closed in order to stifle any flames.
33. The content of feeding bottles and baby food jars are to be stirred or shaken and the temperature is to be checked before consumption, in order to avoid burns.
34. Failure to maintain the oven in a clean condition could lead to deterioration of the surface that could adversely affect the life of the appliance and possibly result in a hazardous situation.
35. The microwave oven shall not be placed in a cabinet.
36. Minimum height of free space necessary above the top surface of the oven: 300mm

SAVE THESE INSTRUCTIONS

To Reduce the Risk of Injury to Persons

Grounding Installation

DANGER

Electric Shock Hazard

Touching some of the internal components can cause serious personal injury or death. Do not disassemble this appliance.

WARNING

Electric Shock Hazard

Improper use of the grounding can result in electric shock. Do not plug into an outlet until appliance is properly installed and grounded.

Insulated plug

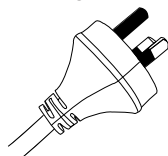

This appliance must be grounded. In the event of an electrical short circuit, grounding reduces the risk of electric shock by providing an escape wire for the electric current. This appliance is equipped with a cord having grounding

wire with a grounding plug. The plug must be plugged into an outlet that is properly installed and grounded.

Consult a qualified electrician or serviceman if the grounding instructions are not completely understood or if doubt exists as to whether the appliance is properly grounded. If it is necessary to use an extension cord, use only a 3-wire extension cord that has a 3-pronged grounding plug, and a 3-slot receptacle that will accept the plug on the appliance.

1. A short power-supply cord is provided to reduce the risks resulting from becoming entangled in or tripping over a longer cord.
2. If a long cord set or extension cord is used:
 - 1) The marked electrical rating of the cord set or extension cord should be at least as great as the electrical rating of the appliance.
 - 2) The extension cord must be a grounding-type 3-wire cord.
3. The longer cord should be arranged so that it will not drape over the countertop or tabletop where it can be pulled on by children or tripped over unintentionally.

CAUTION

Personal Injury Hazard

Tightly-closed utensils could explode. Closed containers should be opened and plastic pouches should be pierced before cooking.

UTENSILS

See the instructions on "Materials you can use in microwave oven or to be avoided in microwave oven." There may be certain non-metallic utensils that are not safe to use for microwaving. If in doubt, you can test the utensil in question following the procedure below.

Utensil Test:

1. Fill a microwave-safe container with 1 cup of cold water (250ml) along with the utensil in question.
2. Cook on maximum power for 1 minute.
3. Carefully feel the utensil. If the empty utensil is warm, do not use it for microwave cooking.
4. Do not exceed 1 minute cooking time.

Materials you can use in microwave oven

Utensils Remarks

Aluminum foil	Shielding only. Small smooth pieces can be used to cover thin parts of meat or poultry to prevent overcooking. Arcing can occur if foil is too close to oven walls. The foil should be at least 1 inch (2.5cm) away from oven walls.
Browning dish	Follow manufacturer's instructions. The bottom of browning dish must be at least 3/16 inch (5mm) above the turntable. Incorrect usage may cause the turntable to break.
Dinnerware	Microwave-safe only. Follow manufacturer's instructions. Do not use cracked or chipped dishes.
Glass jars	Always remove lid. Use only to heat food until just warm. Most glass jars are not heat resistant and may break.
Glassware	Heat-resistant oven glassware only. Make sure there is no metallic trim. Do not use cracked or chipped dishes.
Oven cooking bags	Follow manufacturer's instructions. Do not close with metal tie. Make slits to allow steam to escape.
Paper plates and cups	Use for short-term cooking/warming only. Do not leave oven unattended while cooking.
Paper towels	Use to cover food for reheating and absorbing fat. Use with supervision for a short-term cooking only.
Parchment paper	Use as a cover to prevent splattering or a wrap for steaming.
Plastic	Microwave-safe only. Follow the manufacturer's instructions. Should be labeled "Microwave Safe". Some plastic containers soften, as the food inside gets hot. "Boiling bags" and tightly closed plastic bags should be slit, pierced or vented as directed by package.
Plastic wrap	Microwave-safe only. Use to cover food during cooking to retain moisture. Do not allow plastic wrap to touch food.
Thermometers	Microwave-safe only (meat and candy thermometers).
Wax paper	Use as a cover to prevent splattering and retain moisture.

Materials to be avoided in microwave oven

Utensils Remarks

Aluminum tray	May cause arcing. Transfer food into microwave-safe dish.
Food carton with metal handle	May cause arcing. Transfer food into microwave-safe dish.
Metal or metal-trimmed utensils	Metal shields the food from microwave energy. Metal trim may cause arcing.
Metal twist ties	May cause arcing and could cause a fire in the oven.
Paper bags	May cause a fire in the oven.
Plastic foam	Plastic foam may melt or contaminate the liquid inside when exposed to high temperature.
Wood	Wood will dry out when used in the microwave oven and may split or crack.

SETTING UP YOUR OVEN

Names of Oven Parts and Accessories

Remove the oven and all materials from the carton and oven cavity.

Your oven comes with the following accessories:

Glass tray	1
Turntable ring assembly	1
Instruction Manual	1

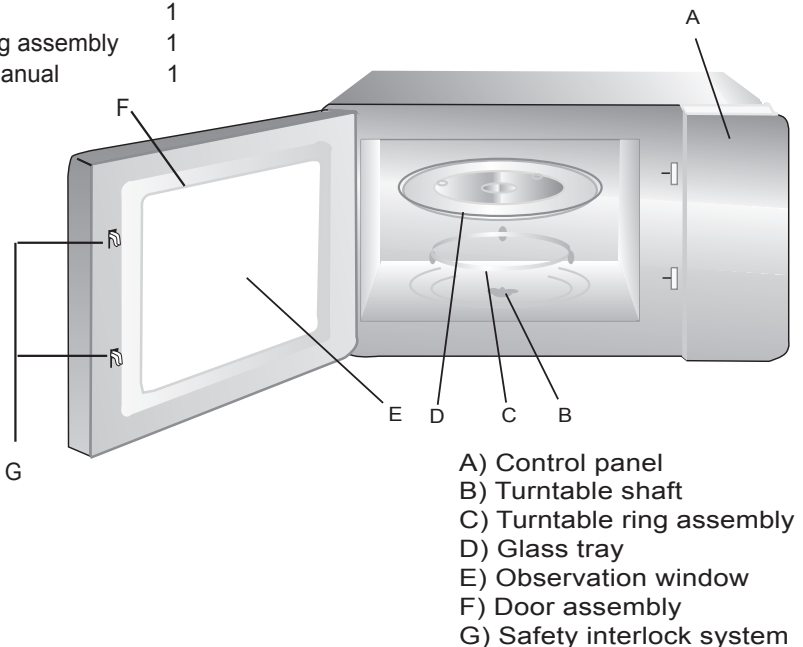

Turntable Installation

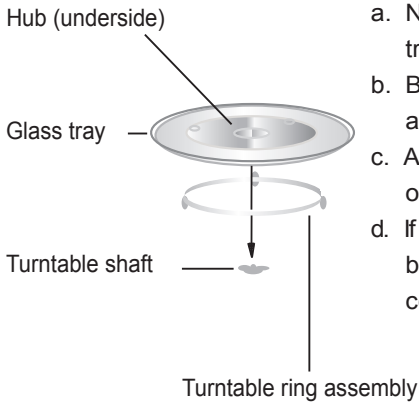

- Never place the glass tray upside down. The glass tray should never be restricted.
- Both glass tray and turntable ring assembly must always be used during cooking.
- All food and containers of food are always placed on the glass tray for cooking.
- If glass tray or turntable ring assembly cracks or breaks, contact your nearest authorized service center.

Countertop Installation

Remove all packing material and accessories. Examine the oven for any damage such as dents or broken door. Do not install if oven is damaged.

Cabinet: Remove any protective film found on the microwave oven cabinet surface. Do not remove the light brown Mica cover that is attached to the oven cavity to protect the magnetron.

Installation

1. Select a level surface that provide enough open space for the intake and/or outlet vents.

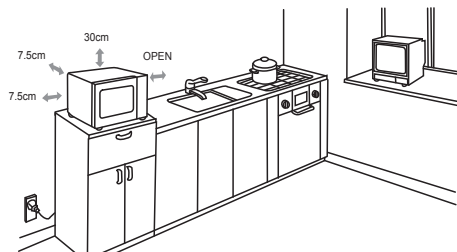

A minimum clearance of **7.5cm** is required between the oven and any adjacent walls. One side must be open.

- (1) Leave a minimum clearance of 30cm above the oven.
- (2) Do not remove the legs from the bottom of the oven.

- (3) Blocking the intake and/or outlet openings can damage the oven.
 - (4) Place the oven as far away from radios and TV as possible. Operation of microwave oven may cause interference to your radio or TV reception.
2. Plug your oven into a standard household outlet. Be sure the voltage and the frequency is the same as the voltage and the frequency on the rating label.

WARNING: Do not install oven over a range cooktop or other heat-producing appliance. If installed near or over a heat source, the oven could be damaged and the warranty would be void.

OPERATION

Control Panel and Features

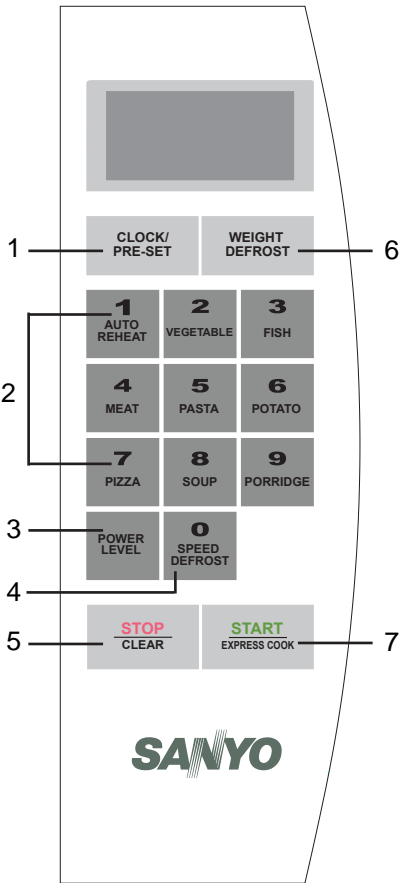

- (1) Clock/Pre-set
- (2) Number keys/Auto Menus
- (3) Power Level
- (4) Speed Defrost
- (5) Stop/Clear: clears all previous settings pressed before cooking starts. During cooking: press once to stop oven, twice to stop and clear all entries.
- (6) Weight Defrost
- (7) Start/ Express cook

Display Window

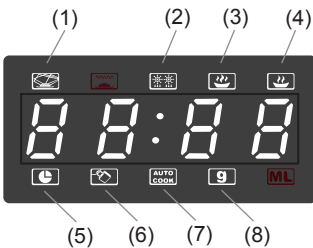

- (1). Microwave
- (2). Defrost
- (3). High power
- (4). Low power
- (5). Time
- (6). Lock function for children
- (7). Auto cook
- (8). Gramme

Operation Instructions

1. Clock Setting

When the microwave oven is electrified, the LED will display "0:00".

The input time should be within 0:00--23:59;

Example: To set 12:12 .

(1) Press the " CLOCK/PRE-SET " button, the hour figures will flash, and the indicator for clock "  " will light.

(2) Press the number buttons of "1","2","1","2" in order.

(3) Press " CLOCK/PRE-SET " to finish clock setting. The indicator for clock "  " will go out, ":" will flash, and the time will light.

Note: In the process of clock setting, if " STOP/CLEAR " is pressed or if there is no operation within 1 minute, the oven will go back to the previous status automatically.



2. Delay Start

Example: to start a cooking at 12:12.

(1) Set the clock first. (Refer to instruction of clock setting.)

(2) Set the cooking program wanted (defrost should not be set here).

Please do not press "START/EXPRESS COOK" to start cooking at the last step.

(3) Press "CLOCK/PRE-SET" to display the current clock. The hour figures flash.

(4) Press "1", "2", "1", "2";

(5) Press "START/EXPRESS COOK" to confirm the setting. The unit will turn back to the clock state. Cooks begin when the time arrives.

Note: (1) If the setting is not within the range 0:00--23:59, the setting will be invalid.

(2) In the process of setting, if "STOP/CLEAR" is pressed or there is no operation within 1 minute, the unit will go back to the previous state automatically.

(3) The clock must be set before the delay start cooking. If the pre-set cooking has not been programmed and only time to start cooking is set, the whole set will be regarded as an alarm clock setting and 5 beeps will be sound when the pre-set time is reached.







3. Microwave Cooking

Select different microwave power level and set cooking time as you wish. There are five power levels available for choosing. Refer to Chart 1. The maximum microwave cooking time is 99 minutes and 99 seconds. Keep on pressing "POWER LEVEL" to choose the power wished.

Microwave Power Chart

Press "POWER LEVEL"	Microwave Power	Display
Once	100%	
Twice	80%	
Thrice	50%	
4 times	30%	
5 times	10%	

Example: Choose 50% power for cooking 10 minutes.



- (1) Press " POWER LEVEL " thrice, " " and " " will light.
- (2) Press the numeral buttons of "1", "0", "0", "0" in order;
- (3) Press " START/EXPRESS COOK " to start cooking, the time will count down. ":", " " and " " will flash.



4. Express Cook

In waiting state, press "**START/EXPRESS COOK**" to start cooking with 100% microwave power for 30 seconds. If the remaining cooking time is no more than one minute and 30 seconds, 30 seconds will be added by each pressing on "**START/EXPRESS COOK**" button. If the remaining cooking time is more than one minute 30 seconds, one minute will be added by each pressing on "**START/EXPRESS COOKING**". The maximum cooking time is 12 minutes.





Example: Set 3 minutes express cook.

- (1) Press " START/EXPRESS COOK " once to start cooking, LED will display "0:30", " " and " " will light.
- (2) Press " START/EXPRESS COOK " again for 4 times, the cooking time will be 3 minutes.



5. Weight Defrost





Example: Defrost beef of 500g:

- (1) Press " WEIGHT DEFROST ", LED will display "dEF1", " " and " " will light.
- (2) Press "5", "0", "0" in order, "g" will light, the range of defrosting weight is 100g-2000g.
- (3) Press "START/EXPRESS COOK" to start defrosting, "g" will go out, " " and " " will flash.



6. Speed Defrost

Example: Defrost beef of 500g

- (1) Press " SPEED DEFROST ", LED displays "dEF2", " " and " " will light.
- (2) Press "5" "0" "0" in order, "g" will light, the range of defrosting weight is 100g-1200g.
- (3) Press "START/EXPRESS COOK" to start defrosting, "g" will go out, " " and " " will flash.









7. Auto Menu Cooking

The numeral pads 1—9 is matching with nine different subjects respectively;

Pad	Display	Cook	Pad	Display	Cook	Pad	Display	Cook
1		Auto Reheat	4		Meat	7		Pizza
2		Vegetable	5		Pasta	8		Soup
3		Fish	6		Potato	9		Porridge

Example: Cook vegetable of 350g:

- (1) Press "VEGETABLE" button, " " and " " will light.
- (2) Press "VEGETABLE" button twice to choose weight, LED will display "350", "g", " " and " " will light.
- (3) Press " START/EXPRESS COOK " to start cooking, "g" will go out, time counts down, " " and " " will flash.



Refer to chart 2 for the automatic menu procedure:

Chart 2:

Menu	Weight(g)	Press Times	Display	Time
A-1 Auto Reheat	150	Once	0 1 5 0	1'30"
	250	Twice	0 2 5 0	2'00"
	350	Thrice	0 3 5 0	2'30"
	400	4 times	0 4 0 0	3'00"
A-2 Vegetable	150	Once	0 1 5 0	2'40"
	350	Twice	0 3 5 0	4'20"
	500	Thrice	0 5 0 0	6'00"
A-3 Fish	150	Once	0 1 5 0	2'30"
	250	Twice	0 2 5 0	3'40"
	350	Thrice	0 3 5 0	4'40"
	400	4 times	0 4 0 0	5'20"
	450	5 times	0 4 5 0	6'20"
A-4 Meat	150	Once	0 1 5 0	3'00"
	300	Twice	0 3 0 0	4'30"
	450	Thrice	0 4 5 0	6'20"
	600	4 times	0 6 0 0	7'40"
A-5 Pasta	50(with cold water 450g)	Once	0 0 5 0	17'00"
	100(with cold water 800g)	Twice	0 1 0 0	20'00"
	150(with cold water 1200g)	Thrice	0 1 5 0	22'00"
A-6 Potato	1(approximately 200g)	Once	0 1 0 0	4'40"
	2(approximately 400g)	Twice	0 2 0 0	7'20"
	3(approximately 600g)	Thrice	0 3 0 0	9'00"
A-7 Pizza	1(approximately 80g)	Once	0 1 0 0	1'00"
	2(approximately 160g)	Twice	0 2 0 0	2'00"
	3(approximately 250g)	Thrice	0 3 0 0	2'50"
A-8 Soup	500	Once	0 5 0 0	22'00"
	750	Twice	0 7 5 0	24'00"
	1000	Thrice	0 0 0 0	27'00"
A-9 Porridge	550	Once	0 5 5 0	8'00"
	1100	Twice	0 1 0 0	12'00"

8. Inquiring Function

- (1) In one stage cooking state, press " POWER LEVEL ", the current microwave power will be displayed for 3 seconds. After three seconds, the oven will turn back to the former state.
- (2) In pre-set or cooking state, press "CLOCK/PRE-SET" to inquire the preset time or present time. Then it will be flashing in the LED for 2-3 seconds, and the oven will turn back to the clock display.
- (3) In cooking state, press "CLOCK/PRE-SET" to inquire the current time.

9. Multi-section cooking

At most 2 sections can be input for cooking. In multi-section cooking, if one section is defrosting, then defrosting shall be placed in the first section.

Note: Auto cooking cannot work in the multi-section cooking.

Example: If you want to cook the food with 100% microwave power for 10 minutes+ 80% microwave power for 15 minutes, follow as below.

- 1) Press "POWER LEVEL" once to choose 100% microwave power.
- 2) Press number keys "1","0","0","0" in order to adjust the cooking time.
- 3) Press "POWER LEVEL" twice to choose 80% microwave power.
- 4) Press number keys "1","5","0","0" in order to adjust the cooking time.
- 5) Press "START/EXPRESS COOK " to start cooking.

10. Lock-out Function for Children

Lock: In waiting state, press " STOP/CLEAR " for 3 seconds, there will be a long beep denoting entering the children-lock state and LED will display "  ".

Unlock: In locked state, press " STOP/CLEAR " for 3 seconds, there will be a long "beep" denoting that the lock is released.

11. Cooking End Reminding Function

When cooking ends, there will be 5 beeps which is reminding the completion of cooking.

12. Display Specification

- (1) In waiting state, LED will display clock and " : " will flash.
- (2) In function setting state, LED will display the related setting.
- (3) In the operation and suspending state, LED will display the residual cooking time.

Trouble shooting

Normal	
Microwave oven interfering TV reception	Radio and TV reception may be interfered when microwave oven operating. It is similar to the interference of small electrical appliances, like mixer, vacuum cleaner, and electric fan. It is normal.
Dim oven light	In low power microwave cooking, oven light may become dim. It is normal.
Steam accumulating on door, hot air out of vents	In cooking, steam may come out of food. Most will get out from vents. But some may accumulate on cool place like oven door. It is normal.
Oven started accidentally with no food in.	It is forbidden to run the unit without any food inside. It is very dangerous.

Trouble	Possible Cause	Remedy
Oven can not be started.	(1) Power cord not plugged in tightly.	Unplug. Then plug again after 10 seconds.
	(2) Fuse blowing or circuit breaker works.	Replace fuse or reset circuit breaker (repaired by professional personnel of our company)
	(3) Trouble with outlet.	Test outlet with other electrical appliances.
Oven does not heat.	(4) Door not closed well.	Close door well.
Glass turntable makes noise when microwave oven operates	(5) Dirty roller rest and oven bottom.	Refer to "Maintenance of Microwave" to clean dirty parts.

SANYO

SANYO Electric Co., Ltd.