

# Microwave Oven

## user manual

imagine the possibilities

Thank you for purchasing a Samsung product. To receive a more complete service, please register your product at

[www.samsung.com/global/register](http://www.samsung.com/global/register)

**SAMSUNG**

# features

---

## **Luxurious look**

---

With the STSS exterior, it provides luxurious look in your kitchen and the design matches great with other kitchen appliances, so that it provides harmonious kitchen interior and finally completes total kitchen solution.

## **Controllable ventilation system**

---

According to duct location and presence, you can set the way of vent orientation. Also, you can choose the ventilation power (High, Low, and Off) depending on the cooking condition.

## **One touch Instant cook pad**

---

You can cook easily and save the time by various instant cooking menu that consists of what you use frequently. Moreover, your OTR provides the best cooking condition of each menu, so that you will be happy with its performance.

## **Child safety Lock**

---

Child safety lock function is with New OTR, so that you can prevent unexpected operation by children.

## **Cook-top lighting**

---











Whenever you cook, cook top lighting is with you. You can also control the degree of lighting(High/Low/Off).

# safety information

---

## WHAT THE ICONS AND SIGNS IN THIS MANUAL MEAN:

---

	<b>WARNING:</b> Hazards or unsafe practices that may result in <b>severe personal injury or death.</b>
	<b>CAUTION:</b> Hazards or unsafe practices that may result in <b>minor personal injury or property damage.</b>
	Do not attempt or use.
	Do not repair.
	Do not touch.
	Be careful
	Follow directions explicitly.
	Unplug the power plug from the wall socket.
	Make sure the machine is grounded to prevent electric shock.
	Call the service center for help.
	Note

## PRECAUTIONS TO AVOID POSSIBLE EXPOSURE TO EXCESSIVE MICROWAVE ENERGY:

---

-  Do not attempt to operate this oven with the door open since open-door operation can result in harmful exposure to microwave energy. It is important not to defeat or tamper with the safety interlocks.

Do not place any object between the oven front face and the door or allow soil or cleaner residue to accumulate on sealing surfaces.

Do not operate the oven if it is damaged. It is particularly important that the oven door close properly and that there is no damage to the

- Door (bent or dented),
- Hinges and latches (broken or loosened),
- Door seals and sealing surfaces.

-  The oven should not be adjusted or repaired by anyone except properly qualified service personnel.

## SAVE THESE INSTRUCTIONS

# IMPORTANT SAFETY INSTRUCTIONS

---

When using any electrical appliance, basic safety precautions should be followed, including the following:

## **WARNING**

-  Always observe Safety Precautions when using your oven. Never try to repair the oven on your own - there is dangerous voltage inside. If the oven needs to be repaired, call **1-800-SAMSUNG (7267864)** for the name of an authorized service center near you.

### **TO REDUCE RISK OF BURNS, ELECTRIC SHOCK, FIRE, PERSONAL INJURY OR EXPOSURE TO EXCESSIVE MICROWAVE ENERGY:**

---

-  Read all safety instructions before using the appliance.

Read and follow the specific **“PRECAUTIONS TO AVOID EXPOSURE TO EXCESSIVE MICROWAVE ENERGY”** on page 3.

This appliance must be grounded. Connect only to properly grounded outlets. See **“IMPORTANT GROUNDING INSTRUCTIONS”** on page 6 of this manual.

Install or place this appliance only in accordance with the installation instructions provided.

Use this appliance only for its intended use as described in the manual. Do not use corrosive chemicals or vapors in this appliance. This type of oven is specifically designed to heat, cook, or dry food. It is not designed for industrial or laboratory use.

As with any appliance, close supervision is necessary when used by children.

Keep the inside of the oven clean. Food particles or spattered oils stuck to the oven walls or floor can cause paint damage and reduce the efficiency of the oven.

Keep cord away from heated surfaces.

When cleaning door and oven surfaces, use only mild, nonabrasive soaps or detergents applied with a sponge or soft cloth.

Remove lids from baby food before heating. After heating baby food, stir well and test temperature by tasting before serving.

This over-the-range oven was designed for use over ranges no wider than 91.44 cm(36 inches). It may be installed over both gas and electric cooking equipment.

-  Liquids, such as water, coffee, or tea are able to be overheated beyond the boiling point without appearing to be boiling. Visible bubbling or boiling when the container is removed from the microwave oven is not always present. **THIS COULD RESULT IN VERY HOT LIQUIDS SUDDENLY BOILING OVER WHEN THE CONTAINER IS DISTURBED OR A SPOON OR OTHER UTENSIL IS INSERTED INTO THE LIQUID.**

Carefully remove container coverings, directing steam away from hands and face.

Some items, like whole eggs and food in sealed containers, may explode if heated in this oven.

## SAVE THESE INSTRUCTIONS

-  Do not operate this appliance if it has a damaged cord or plug, if it is not working properly, or if it has been damaged.

Do not cover or block any of the openings on this appliance.

Do not store this appliance outdoors. Do not use near water - for example, near a kitchen sink, in a wet basement, or near a swimming pool, etc.

Do not immerse cord or plug in water.

Do not let cord hang over edge of table or counter.

Do not try to preheat oven or operate while empty.

Do not cook without the glass tray in place on the oven floor. Food will not cook properly without the tray.

Do not defrost frozen beverages in narrow-necked bottles. The containers can break.

Dishes and containers can become hot. Handle with care.

Do not operate any other heating or cooking appliance beneath this appliance.

Do not mount unit over or near any portion of a heating or cooking appliance.



Do not mount over a sink.

Do not store anything directly on top of the appliance when it is in operation.

-  This appliance should be serviced only by qualified service personnel. Contact the nearest authorized service facility for examination, repair, or adjustment.

#### **TO REDUCE THE RISK OF FIRE IN THE OVEN:**

---

-  Remove wire twist-ties from plastic cooking bags before placing bags in oven.
-  Do not use the oven compartment for storage purposes. Do not leave paper products, cooking utensils, or food in the oven when not in use.

Do not overcook food. Watch appliance carefully if paper, plastic, or other combustible materials are inside.
-  If materials inside the oven ignite, keep the oven door closed, turn the oven off, disconnect the power cord, or shut off the power at the fuse or circuit breaker panel. If the door is opened, the fire may spread.

#### **TO REDUCE THE RISK OF INJURY TO PERSONS:**

---

-  Stir the liquid both before and halfway through heating it.

After heating, allow the container to stand in the microwave oven for a short time before removing the container.
-  Do not use straight-sided containers with narrow necks.

Do not overheat the liquid.
-  Use extreme care when inserting a spoon or other utensil into the container.



## **SAVE THESE INSTRUCTIONS**

# IMPORTANT GROUNDING INSTRUCTIONS

---

-  This appliance must be grounded. In the event of an electrical short circuit, grounding reduces the risk of electric shock by providing an escape wire for the electrical current. This appliance is equipped with a cord that includes a grounding wire and a grounding plug. The plug must be plugged into an outlet that is properly installed and grounded. Plug the three-prong power cord into a properly grounded outlet of standard 115-120 voltage, 60 Hz. Your oven should be the only appliance on this circuit.

## **WARNING**

-  Improper use of the grounding plug can result in a risk of electric shock. Consult a qualified electrician or servicer if you do not understand the grounding instructions or if you are not sure if the appliance is properly grounded.
-  Do not use an extension cord with this appliance. If the power cord is too short, have a qualified electrician or service technician install an outlet near the appliance.  
  
Do not cut or remove the third (ground) prong from the power cord under any circumstances.
-  Connect the oven only to a 15A dedicated circuit.

# THE VENT FAN



---

-  The fan will operate automatically under certain conditions. Take care to prevent the starting and spreading of accidental cooking fires while the vent fan is in use.

In the event of a grease fire on the surface units below the microwave oven, smother a flaming pan on the surface unit by covering the pan completely with a lid, a cookie sheet or a flat tray.

Clean Ventilating Hoods Frequently - Grease should not be allowed to accumulate on hood of filter.

When flaming foods under the hood, turn the fan on.

-  Use care when cleaning the vent-hood filter. Corrosive cleaning agent, such as lye-based oven cleaner, may damage the filter.
-  Never leave surface units beneath your microwave oven unattended at high heat settings. Boilovers cause smoking and greasy spillovers that may ignite and spread if the microwave vent fan is operating. To minimize automatic fan operation, use adequate sized cookware and use high heat on surface units only when necessary.

# SAVE THESE INSTRUCTIONS

# contents

---

## **YOUR NEW MICROWAVE OVEN**

8

## **BEGINNING**

12

## **QUICK GUIDE**

13

## **OPERATING THE OVEN**

14

## **COOKING INSTRUCTIONS**

22

## **MAINTENANCE**

26

## **WARRANTY**

31

- 8 Checking parts
- 9 Warranty and Service Information
- 9 Setting up your Microwave Oven
- 10 Control panel feature
- 12 Turning on the power
- 12 Setting the clock
- 12 Setting the sound on/off
- 12 Setting the child protection lock
- 12 Using the demonstration mode
- 13 Using the your new microwave oven
- 14 Using the kitchen timer pad
- 14 Using the one minute+ pad
- 14 Using the more/less pads
- 14 Using the vent hi/lo/off pad
- 14 Using the light hi/lo/off pad
- 15 Using the instant cook pads
- 16 Using the cook pad
- 17 Using the reheat pad
- 18 Using the auto defrost pad
- 20 Using the microwave setting cooking times & power levels
- 22 Cooking utensils
- 23 Testing utensils
- 23 General microwave tips
- 24 Cooking techniques
- 25 Cooking Guide
- 26 Troubleshooting
- 27 Care and Cleaning
- 28 Cooktop/night light replacement
- 28 Oven light replacement
- 29 Cleaning the grease filter
- 30 Charcoal filter replacement
- 30 Specifications

# your new microwave oven

## CHECKING PARTS

Unpack your microwave oven and check to make sure that you have all the parts shown here. If any part is missing or broken, call your dealer.

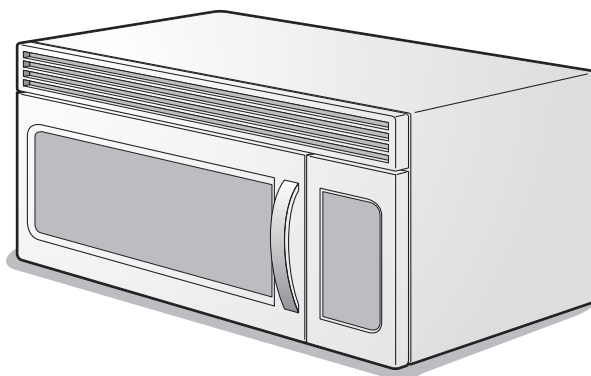

**Microwave oven**

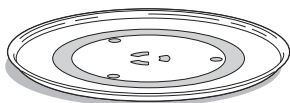

**Glass Tray**



**Roller Guide Ring**

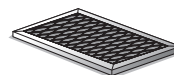

**Charcoal filter**

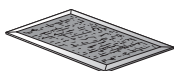

**Grease Filter**

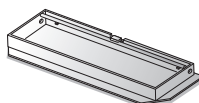

**Exhaust adaptor**



**Hardware-kit**

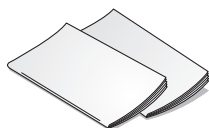

**Manuals  
(User & Installations)**

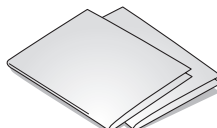

**Templates (Top & Wall)**

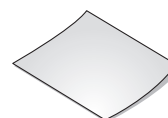

**Registration Card**



## WARRANTY AND SERVICE INFORMATION

---

To help us to serve you better, please complete the enclosed registration card and promptly return it by mail. If the registration card is missing, you can call Samsung Electronics, Inc., at **1-800-SAMSUNG (7267864)**.

When contacting Samsung, please provide the specific model and serial number information which is usually located on the back or bottom of the product. Please record these numbers below, along with the other requested information. Keep this information in a safe place as a permanent record of your purchase to aid in identification in case of theft or loss, and a copy of your sales receipt as a proof of purchase if warranty service is needed.

**MODEL NUMBER** \_\_\_\_\_  
**SERIAL NUMBER** \_\_\_\_\_  
**DATE PURCHASED** \_\_\_\_\_  
**PURCHASED FROM** \_\_\_\_\_

Warranty service can only be performed by a Samsung Authorized Service Center. If you should require warranty service, provide the above information with a copy of your sales receipt to the Samsung Authorized Service Center.

For service assistance and the location of the nearest service center, please call **1-800-SAMSUNG (7267864)**.

## SETTING UP YOUR MICROWAVE OVEN

---

1. Open the oven door by pulling the handle on the right side of the door.

2. Wipe the inside of the oven with a damp cloth.

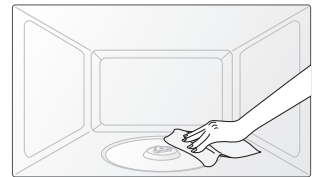

3. Place the pre-assembled ring in the indentation in the center of the oven.

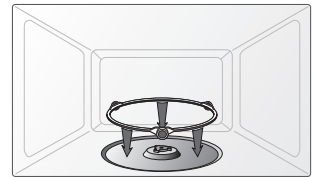

4. Place the glass tray securely in the center of the pre-assembled roller guide.

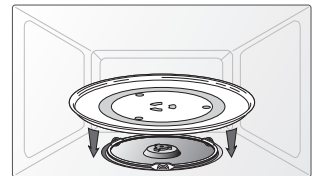

## CONTROL PANEL FEATURE

Read the instructions carefully before using the microwave oven.

For satisfactory use of your oven, become familiar with the various features and functions of the oven as described below. Detailed instructions for each feature and function follow later in this user manual.

### Display

The display includes a clock and indicators to tell you time of day, cooking time settings and cooking functions selected.

### Instant cook pads

Learn more about this features on page 15.

### Auto Defrost

Touch this pad to defrost food by weight.  
Learn more about this features on page 18.

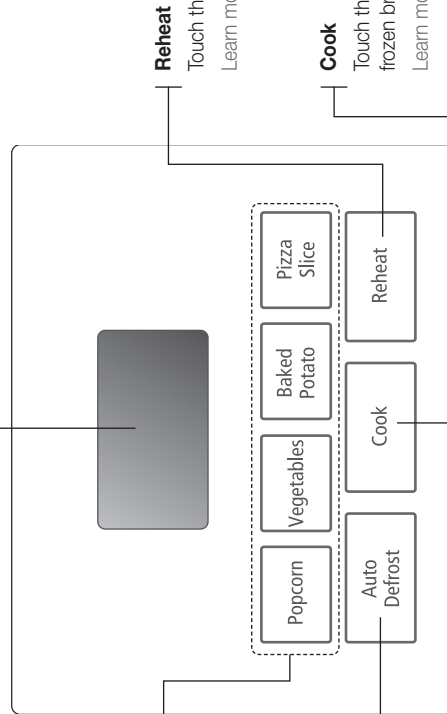

### Reheat

Touch this pad to reheat dinner plate, casserole, and pasta.  
Learn more about this features on page 17.

### Cook

Touch this pad to cook beverage, bacon, frozen dinner, frozen breakfast.  
Learn more about this features on page 16.

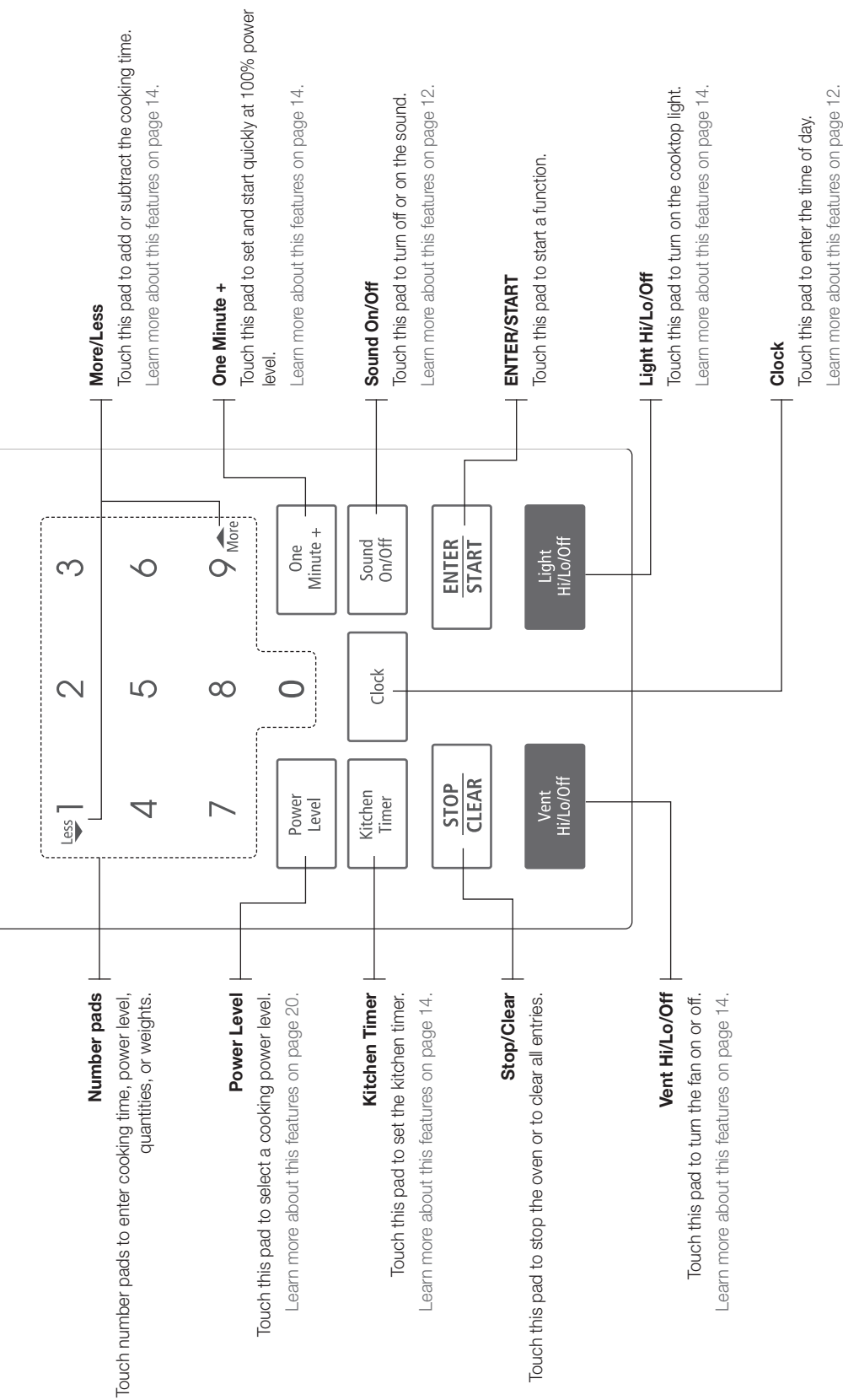

# beginning

---

This section introduces you to the basics you need to know to operate your microwave oven. Please read this information before use.

## SETTING THE CLOCK

---

Touch this pad to enter the time of day.

1. Touch **CLOCK** pad.
2. Enter the time by using the number pads.
3. Touch **ENTER/START** pad.

## SETTING THE SOUND ON/OFF

---

Touch this pad to turn off or on the sound of the oven.

1. Touch **SOUND ON/OFF** pad. The display shows *On*.
2. Touch **SOUND ON/OFF** pad. The display shows *OFF*.
3. Touch **ENTER/START** pad. The display returns to the time of day.

## SETTING THE CHILD PROTECTION LOCK

---

You may lock the control panel to prevent the microwave from being accidentally started or used by children.

The Child Lock feature is also useful when cleaning the control panel. Child Lock prevents accidental programming when wiping the control panel.

### To set the child lock.

---

1. Touch and hold **ENTER/START** pad more than 3 seconds. *L* will appear in the display window with one beep.

### To cancel the child lock

---

1. Touch and hold **ENTER/START** pad more than 3 seconds. *L* will disappear and you hear one beep.

## USING THE DEMONSTRATION MODE

---

You can use the Demonstration mode to see how your microwave oven operates without the oven heating.

1. Touch **0** pad and **1** pad at the same time.
2. To turn demo mode off, repeat step 1 above.

## USING THE YOUR NEW MICROWAVE OVEN

---

### One minute cooking

---

1. Touch **ONE MINUTE +** pad once for each minute of cooking.
2. The time will be displayed and the oven will start.
  - See page 14 for more informations

### One stage cooking

---

1. Use function pads to set cooking time.
2. Touch **ENTER/START** pad.
  - See page 15~17 for more informations

### Auto Defrost

---

1. Touch **AUTO DEFROST** pad.
2. Enter weight of food by touching **AUTO DEFROST** pad repeatedly or using the number pads.
3. Touch **ENTER/START** pad.
4. When the oven beeps, turn food over. Touch **ENTER/START** pad to resume defrosting cycle.
  - See page 18 for more informations

### Set cooking time and power levels

---

1. Use function pads to set cooking time.
2. To set higher power level, touch **POWER LEVEL** pad and use the number pads to enter the power level.
3. Touch **ENTER/START** pad to begin cooking.
  - See page 20 for more informations

# operating the oven

---

## USING THE KITCHEN TIMER PAD

---

You can use your microwave oven as a timer. Use the Kitchen Timer for timing up to 99 minutes, 99 seconds.

1. Touch **KITCHEN TIMER** pad.
2. Enter the time by using the number pads.
3. Touch **ENTER/ START** pad.

When the time is over, you will hear beeps and *End* will display.

## USING THE ONE MINUTE+ PAD

---

This button offers a convenient way to heat food in one-minute increments at the high power level.

1. Touch the **ONE MINUTE +** pad once for each minute you wish to cook the food. For example, touch it twice for two minutes. The time will display, and the oven starts automatically.
2. Add minutes to a program in progress by touching the **ONE MINUTE +** pad for each minute you want to add.

## USING THE MORE/LESS PADS

---

The **MORE(9)/LESS(1)** pads allow you to adjust pre-set cooking times. They only work in the **Reheat, Auto Cooking, One Minute +, Time Cook modes**. Use the **MORE(9)/LESS(1)** pads only after you have already begun cooking with one of these procedures.

1. To add more time to an automatic cooking procedure: Touch the **MORE(9)** pad.
2. To reduce the time of an automatic cooking procedure: Touch the **LESS(1)** pad.

## USING THE VENT HI/LO/OFF PAD

---

The vent moves steam and other vapors from the cooking surface. The vent will operate at low speed whenever the oven is on.

1. To operate the vent manually: Touch **VENT HI/LO/OFF** pad once for high fan speed, twice for low fan speed, or three times to turn the fan off.



If the temperature gets too hot around the microwave oven, the fan in the vent hood will automatically turn on at the low setting to cool the oven. The fan will automatically turn off when the internal parts are cool. When this occurs, the vent cannot be turned off.

## USING THE LIGHT HI/LO/OFF PAD

---

- 1 Touch **LIGHT HI/LO/OFF** pad once for bright light, twice for night light, or three times to turn the light off.

## USING THE INSTANT COOK PADS

### Popcorn, Potato, Pizza slice

1. Touch the pad corresponding to the food you are cooking (**POPCORN**, for example). The display shows: *3.5 OZ*
2. Touch the pad repeatedly to select the serving size you want. The display will cycle through all available serving sizes. Once you select the correct serving size, the microwave will begin cooking automatically.

### Vegetables

**Example: to cook 3 servings of frozen vegetables.**

1. Touch **Vefetables** pad twice.
2. Touch number pads to enter serving size.
3. Touch **ENTER/START** pad.

### Instant cook guide

CATEGORY		DIRECTIONS	AMOUNT
<b>Popcorn</b>		Use only one microwave-only bag of popcorn at a time. Use caution when removing and opening the hot bag from oven. Let oven cool for at least 5 minutes before using again.	3.0-3.5 oz 1 package
<b>Potato</b>		Prick each potato several times with fork. Place on turntable in spoke-like fashion. Let stand 3-5 minutes. Let oven cool for at least 5 minutes before using again. Use <b>MORE(9)</b> pad when cooking larger potatoes.	1 to 4 potatoes
<b>Vegetables</b>	<b>(Fr-1) Fresh</b>	Place fresh vegetables in microwave-safe ceramic, glass or plastic dish and add 2-4 Tbs. water. Cover with lid or vented plastic wrap during cooking and stir before standing. Let oven cool for at least 5 minutes before using again. Use <b>MORE(9)</b> pad when cooking dense vegetables such as carrots or broccoli spears.	1 to 4 servings
	<b>(Fr-2) Frozen</b>	Place frozen vegetables in microwave-safe ceramic, glass or plastic dish and add 2-4 Tbs. water. Cover with lid or vented plastic wrap during cooking and stir before standing. Let oven cool for at least 5 minutes before using again. Use <b>MORE(9)</b> pad when cooking dense vegetables such as carrots or broccoli spears.	1 to 4 servings
<b>Pizza slice</b>		Put 1-3 slices of pizza on a microwave-safe plate with wide end of slice toward the outside edge of the plate. Do not let slices overlap. Do not cover. Let oven cool for at least 5 minutes before using again. Use <b>MORE(9)</b> pad to increase reheat time for thick crust pizza.	1 to 3 slices



Desired food temperature varies from person to person. Use the **MORE(9)/LESS(1)** pads to fit your temperature preference.

## USING THE COOK PAD

Cook pad provides four preset categories for cooking.

CATEGORY	TIMES TO TOUCH	DISPLAY
<b>Beverage</b>	once	Ac-1
<b>Bacon</b>	twice	Ac-2
<b>Frozen dinner</b>	three times	Ac-3
<b>Frozen breakfast</b>	four times	Ac-4

**Example: to cook 8 ozs of frozen dinner.**

1. Touch **COOK** pad three times.
2. Touch number pads to enter quantity, serving size or package weight.
3. Touch **ENTER/START** pad.

When the cook time is over, you will hear four beeps and *End* will display.

### Cook guide

CATEGORY	DIRECTIONS	AMOUNT
<b>Beverage</b>	Use measuring cup or mug; do not cover. Place the beverage in the oven. After heating, stir well. Let oven cool for at least 5 minutes before using again. Note: <ul style="list-style-type: none"> <li>• Reheat times based on an 8 ounce cup.</li> <li>• Beverage heated with the beverage feature may be very hot.</li> <li>• Remove container with care.</li> </ul>	0.5 cup 1 cup 2 cups
<b>Bacon</b>	Place 2 paper towels on plate and arrange bacon on towels, do not overlap. Cover with additional paper towel. Remove paper towel immediately after cooking. Use <b>MORE(9)/LESS(1)</b> pads for desired crispness.	2 to 6 slices
<b>Frozen Dinner</b>	Remove food from outer wrapping and follow box instructions for covering and standing. Let oven cool for at least 5 minutes before using again.	8 to 14 oz.
<b>Frozen Breakfast</b>	Follow package instructions for covering and standing. Use this pad for frozen sandwich, breakfast entree, etc. Let oven cool for at least 5 minutes before using again.	4 to 8 oz.



Desired food temperature varies from person to person. Use the **MORE(9)/LESS(1)** pads to fit your temperature preference.



## USING THE REHEAT PAD

Reheat pad provides three preset categories for reheating.

CATEGORY	TIMES TO TOUCH	DISPLAY
<b>Dinner Plate</b>	once	rh-1
<b>Casserole</b>	twice	rh-2
<b>Pasta</b>	three times	rh-3

**Example: to reheat 3 servings of casserole.**

1. Touch **REHEAT** pad twice.
2. Touch number pads to enter quantity/servings.
3. Touch **ENTER/START** pad.

When the cook time is over, you will hear four beeps and *End* will display.

### Reheat guide

CATEGORY	DIRECTIONS	AMOUNT
<b>Dinner Plate</b>	Use only pre-cooked, refrigerated foods. Cover plate with vented plastic wrap or waxed paper, tucked under plate. If food is not as hot as you prefer after heating with reheat, continue heating using time and power. Contents: <ul style="list-style-type: none"> <li>• 3-4 oz. meat, poultry or fish (up to 6 oz. with bone)</li> <li>• ½ cup starch (potatoes, pasta, rice, etc.)</li> <li>• ½ cup vegetables (about 3-4 oz.)</li> </ul>	1 serving (1 plate)
<b>Casserole</b>	Cover plate with lid or vented plastic wrap. If food is not as hot as you prefer after heating with reheat, continue heating using time and power. Stir foods once before serving. Contents: <ul style="list-style-type: none"> <li>• 3-4 oz. meat, poultry or fish (up to 6 oz. with bone)</li> <li>• ½ cup starch (potatoes, pasta, rice, etc.)</li> <li>• ½ cup vegetables (about 3-4 oz.)</li> </ul>	1 to 4 servings
<b>Pasta</b>		



- Desired food temperature varies from person to person. Use the **MORE(9)/LESS(1)** pads to fit your temperature preference.
- Allow food to stand 1 to 5 minutes before serving.

## USING THE AUTO DEFROST PAD

---

Defrost choices are preset in the oven. The defrost feature provides you with the best defrosting method for frozen foods, because the oven automatically sets the defrosting times according to the weight you enter. For added convenience, the auto defrost beeps to remind you to check or turn over the food during the defrost cycle.

After touching the **AUTO DEFROST** pad once, select the food weight. Available weight ranges are 0.1 To 6.0 Lbs.

1. Touch **AUTO DEFROST** pad.
2. Touch number pads to enter the weight.
3. Touch **ENTER/START** pad.



- After you touch **ENTER/ START** pad, the display counts down the defrost time. The oven will beep twice during the defrost cycle. At this time, open the door and turn the food as needed. Remove any portions that have thawed then return frozen portions to the oven and touch **ENTER/START** pad to resume the defrost cycle.
- The oven will not stop during the beep unless the door is opened.

### Defrost tips

---

- When using auto defrost, the weight to be entered is the net weight in pounds and tenths of pounds (the weight of the food minus the container).
- Use auto defrost only for raw food. Auto defrost gives best results when food to be thawed is a minimum of 0°f (taken directly from a true freezer). If food has been stored in a refrigerator-freezer that does not maintain a temperature of 5°f or below, always program a lower food weight (for a shorter defrosting time) to prevent cooking the food.
- If the food is stored outside the freezer for up to 20 minutes, enter a lower food weight.
- The shape of the package alters the defrosting time. Shallow rectangular packets defrost more quickly than a deep block.
- Separate pieces as they begin to defrost. Separated pieces defrost more easily.
- Shield areas of food with small pieces of foil if they start to become warm.
- You can use small pieces of aluminum foil to shield foods like chicken wings, leg tips, and fish tails, but the foil must not touch the side of the oven. Foil causes arcing, which can damage the oven lining.

## Auto defrosting guide

Follow the instructions below when defrosting different types of food.

CATEGORY	PROCEDURE	STANDARD AMOUNT
<b>Roast Beef, Pork</b>	Start with the food placed fat side down. After each stage, turn the food over and shield any warm portions with narrow strips of aluminum foil.	2.5-6.0 lbs.
<b>Steaks, Chops, Fish</b>	After each stage, rearrange the food. If there are any warm or thawed portions of food, shield them with narrow flat pieces of aluminum foil. Remove any pieces of food that are nearly defrosted. Let stand, covered, for 5-10 minutes.	0.5-3.0 lbs.
<b>Ground Meat</b>	After each stage, remove any pieces of food that are nearly defrosted. Let stand, covered with foil, for 5-10 minutes.	0.5-3.0 lbs.
<b>Whole Chicken</b>	Remove giblets before defrosting poultry. Start defrosting with the breast side down. After the first stage, turn the chicken over and shield any warm portions with narrow strips of aluminum foil. After the second stage, again shield any warm portions with narrow strips of aluminum foil. Let stand, covered, for 30-60 minutes in the refrigerator.	2.5-6.0 lbs.
<b>Chicken Pieces</b>	After each stage, rearrange or remove any pieces of food that are nearly defrosted. Let stand for 10-20 minutes.	0.5-3.0 lbs.
<b>Bread</b>	Arrange rolls in a circle horizontally on kitchen paper in the middle of turntable. Turn over after half of defrosting time.	0.1-2.0 lbs.



Check foods when the oven signals. After the final stage, small sections may still be icy; let them stand to continue thawing. Do not defrost until all ice crystals have thawed. Shielding roasts and steaks with small pieces of foil prevents the edges from cooking before the center of the food has defrosted. Use narrow, flat, smooth strips of aluminum foil to cover the edges and thinner sections of the food.

## USING THE MICROWAVE SETTING COOKING TIMES & POWER LEVELS

---

Your oven allows you to set up three different stages of cooking, each with its own time length and power level. The power level lets you control the heating intensity from Warm (1) to High (10/Power level).

### Cooking at high power levels

---

1. Touch number pads to enter the cook time.
2. Touch **ENTER/ START** pad.

When the cook time is over, you will hear four beeps and *End* will display.

### Cooking at lower power levels

---

High power cooking does not always give you the best results with foods that need slower cooking, such as roasts, baked goods, or custards. Your oven has 9 power settings in addition to high.

1. Touch number pads to enter the cook time.
2. Touch **POWER LEVEL** pad.
3. Touch number pads to enter the power level.
4. Touch **ENTER/ START** pad.

When the cook time is over, you will hear four beeps and *End* will display.

### Cooking with more than one cook cycle

---

For best results, some recipes call for one Power Level for a certain length of time, and another Power Level for another length of time. Your oven can be set to change from one to another automatically, for up to three cycles at the first cycle is defrost.

1. Touch number pads to enter the cook time.
2. Touch **POWER LEVEL** pad.
3. Touch number pads to enter the power level.
4. Touch number pads to enter the second cook time.
5. Touch **POWER LEVEL** pad.
6. Touch number pads to enter the power level.
7. Touch **ENTER/ START** pad.

When the cook time is over, you will hear four beeps and *End* will display.

## Cooking guide for power levels

The 9 power levels in addition to high allow you to choose the best power level for the food you are cooking. Below are listed all the power levels, examples of foods best cooked at each level, and the amount of microwave power you are using.

POWER LEVEL	MICROWAVE OUTPUT	USE
<b>10 (High)</b>	100 %	<ul style="list-style-type: none"> <li>• Boil water.</li> <li>• Cook ground beef.</li> <li>• Make candy.</li> <li>• Cook fresh fruits and vegetables.</li> <li>• Cook fish and poultry.</li> <li>• Preheat browning dish.</li> <li>• Reheat beverages.</li> <li>• Bacon slices.</li> </ul>
<b>9</b>	90 %	<ul style="list-style-type: none"> <li>• Reheat meat slices quickly.</li> <li>• Saute onions, celery, and green pepper.</li> </ul>
<b>8</b>	80 %	<ul style="list-style-type: none"> <li>• All reheating.</li> <li>• Cook scrambled eggs.</li> </ul>
<b>7</b>	70 %	<ul style="list-style-type: none"> <li>• Cook breads and cereal products.</li> <li>• Cook cheese dishes, veal.</li> <li>• Cook cakes, muffins, brownies, cupcakes.</li> </ul>
<b>6</b>	60 %	<ul style="list-style-type: none"> <li>• Cook pasta.</li> </ul>
<b>5</b>	50 %	<ul style="list-style-type: none"> <li>• Cook meats, whole poultry.</li> <li>• Cook custard.</li> <li>• Cook whole chicken, turkey, spare ribs, rib roast, sirloin roast.</li> </ul>
<b>4</b>	40 %	<ul style="list-style-type: none"> <li>• Cook less tender cuts of meat.</li> <li>• Reheat frozen convenience foods.</li> </ul>
<b>3</b>	30 %	<ul style="list-style-type: none"> <li>• Thaw meat, poultry, and seafood.</li> <li>• Cook small quantities of food.</li> <li>• Finish cooking casserole, stew, and some sauces.</li> </ul>
<b>2</b>	20 %	<ul style="list-style-type: none"> <li>• Soften butter and cream cheese.</li> <li>• Heat small amounts of food.</li> </ul>
<b>1</b>	10 %	<ul style="list-style-type: none"> <li>• Soften ice cream.</li> <li>• Raise yeast dough.</li> </ul>

# cooking instructions

---

## COOKING UTENSILS

---

### Recommended use

---

- **Glass and glass** - ceramic bowls and dishes - Use for heating or cooking.
- **Microwavable plastic wrap** - Use to cover. Leave a small opening for some steam to escape and avoid placing it directly on the food.
- **Wax paper** - Use as a cover to prevent spattering.
- **Paper towels and napkins** - Use for short-term heating and covering; they absorb excess moisture and prevent spattering. Do not use recycled paper towels, which may contain metal and can catch fire.
- **Paper plates and cups** - Use for short-term heating at low temperatures. Do not use recycled paper, which may contain metal and can catch fire.
- **Thermometers** - Use only those labeled "Microwave-Safe" and follow all directions. Check the food in several places. Conventional thermometers may be used once the food has been removed from the oven.

### Limited use

---

- **Aluminum foil** - Use narrow strips of foil to prevent overcooking of exposed areas. Using too much foil can damage your oven, so be careful.
- **Ceramic, porcelain, and stoneware** - Use these if they are labeled "Microwave-Safe". If they are not labeled, test them to make sure they can be used safely. Never use dishes with metallic trim.
- **Plastic** - Use only if labeled "Microwave-Safe". Other plastics can melt.
- **Straw, wicker, and wood** - Use only for short-term heating, as they can be flammable.

### Not recommended

---

- **Glass jars and bottles** - Regular glass is too thin to be used in a microwave, and can shatter.
- **Paper bags** - These are a fire hazard, except for popcorn bags that are designed for microwave use.
- **Styrofoam plates and cups** - These can melt and leave an unhealthy residue on food.
- **Plastic storage and food containers** - Containers such as margarine tubs can melt in the microwave.
- **Metal utensils** - These can damage your oven. Remove all metal before cooking.

## TESTING UTENSILS

---

If you are not sure whether a dish is microwave-safe or not, you can perform this test:

1. Fill 1 cup of glass measuring cup with water and put it inside your oven, next to the dish you want to test.

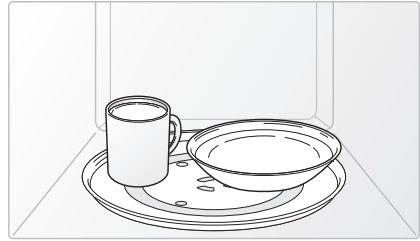

2. Touch the **ONE MINUTE +** button once to heat them for one minute at high power.

The water should be warm and the dish you are testing should be cool. If the dish is warm, then it is absorbing microwave energy and is not acceptable for use in the microwave.

## GENERAL MICROWAVE TIPS

---

- Dense foods, such as potatoes, take longer to heat than lighter foods. Foods with a delicate texture should be heated at a low power level to avoid becoming tough.
- Altitude and the type of cookware you are using can affect cooking time. When using a new recipe, use the minimum cooking time and check the food occasionally to prevent overcooking.
- Foods with a non-porous skin such as potatoes or hot dogs, should be pierced to prevent bursting.
- Frying with heating oil or fat is not recommended. Fat and oil can suddenly boil over and cause severe burns.
- Some ingredients heat faster than others. For example a jelly doughnut will be hotter than the dough. Keep this in mind to avoid burns.
- Home canning in the microwave oven is not recommended because all harmful bacteria may not be destroyed by the microwave heating process.
- Although microwaves do not heat the cookware, the heat from the food is often transferred to the cookware. Always use pot holders when removing food from the microwave and instruct children to do the same.
- Making candy in the microwave is not recommended as candy can be heated to very high temperatures. Keep this in mind to avoid injury.

# COOKING TECHNIQUES

---

## Stirring

---

Stir foods such as casseroles and vegetables while cooking to distribute heat evenly. Food at the outside of the dish absorbs more energy and heats more quickly, so stir from the outside to the center. The oven will turn off when you open the door to stir your food.

## Arrangement

---

Arrange unevenly shaped foods, such as chicken pieces or chops, with the thicker, meatier parts toward the outside of the turntable where they receive more microwave energy. To prevent overcooking, place thin or delicate parts toward the center of the turntable.

## Shielding

---

Shield food with narrow strips of aluminum foil to prevent overcooking. Areas that need shielding include poultry wing-tips, the ends of poultry legs, and corners of square baking dishes. Use only small amounts of aluminum foil. Larger amounts can damage your oven.

## Turning

---

Turn foods over midway through cooking to expose all parts to microwave energy. This is especially important with large items such as roasts.

## Standing

---

Foods cooked in the microwave build up internal heat and continue to cook for a few minutes after the oven stops. Let foods stand to complete cooking, especially foods such as roasts and whole vegetables. Roasts need this time to complete cooking in the center without overcooking the outer areas. All liquids, such as soup or hot chocolate, should be shaken or stirred when cooking is complete. Let liquids stand a moment before serving. When heating baby food, stir well and test the temperature before serving.

## Adding moisture

---

Microwave energy is attracted to water molecules. Food that is uneven in moisture content should be covered or allowed to stand so that the heat disperses evenly. Add a small amount of water to dry food to help it cook.

## Venting

---

After covering dish with plastic wrap, you vent plastic wrap by turning back one corner so excess steam can escape.



### Guide for cooking eggs in your microwave

---

- Never cook eggs in the shell, and never warm hard-cooked eggs in the shell; they can explode.
- Always pierce whole eggs to keep them from bursting.
- Cook eggs just until set; they become tough if overcooked.

### Guide for cooking vegetables in your microwave

---

- Vegetables should be washed just before cooking. Often, no extra water is needed. If dense vegetables such as potatoes, carrots and green beans are being cooked, add about  $\frac{1}{4}$  cup of water.
- Small vegetables (sliced carrots, peas, lima beans, etc.) Can be cooked faster than larger ones.
- Whole vegetables, such as potatoes, acorn squash or corn on the cob, should be arranged in a circle on the turntable before cooking. They will be cooked more evenly if turned over after half the cooking time.
- Always place vegetables like asparagus and broccoli with the stem ends pointing towards the edge of the dish and the tips toward the center.
- When cooking cut vegetables, always cover the dish with a lid or vented microwavable plastic wrap.
- Whole, unpeeled vegetables such as potatoes, squash, eggplant, etc., Should have their skin pricked in several spots before cooking to prevent them from bursting.
- For more even cooking, stir or rearrange whole vegetables halfway through the cooking time.
- Generally, the denser the food, the longer the standing time. (Standing time refers to the time necessary for dense, large foods and vegetables to finish cooking after they come out of the oven.) A baked potato can stand on the counter for five minutes before cooking is completed, while a dish of peas can be served immediately.

# maintenance

---

## TROUBLESHOOTING

---

Before you call a repair person for your oven, check this list of possible problems and solutions.

PROBLEM	SOLUTIONS
<b>Neither the oven's display nor the oven operate.</b>	<ul style="list-style-type: none"><li>• Properly insert the plug into a grounded outlet.</li><li>• If the outlet is controlled by a wall switch, make sure the wall switch is turned on.</li><li>• Remove the plug from the outlet, wait ten seconds, then plug it in again.</li><li>• Reset the circuit breaker or replace any blown fuse.</li><li>• Plug another appliance into the outlet; if the other appliance doesn't work, have a qualified electrician repair the outlet.</li><li>• Plug the oven into a different outlet.</li></ul>
<b>The oven's display works, but the power won't come on.</b>	<ul style="list-style-type: none"><li>• Make sure the door is closed securely.</li><li>• Check to see if packing material or other material is stuck to the door seal.</li><li>• Check for door damage.</li><li>• Touch Cancel twice and re-enter all cooking instructions.</li></ul>
<b>The power goes off before the set time has elapsed.</b>	<ul style="list-style-type: none"><li>• If there has not been a power outage, remove the plug from the outlet, wait ten seconds, then plug it in again. If there was a power outage, the time indicator will display: 88:88.</li><li>• Reset the clock and any cooking instructions.</li><li>• Reset the circuit breaker or replace any blown fuse.</li></ul>
<b>The food is cooked too slowly.</b>	<ul style="list-style-type: none"><li>• Make sure the oven is on its own 20 amp circuit line. Operating another appliance on the same circuit can cause a voltage drop. If necessary, move the oven to its own circuit.</li></ul>
<b>You see sparks or arcing.</b>	<ul style="list-style-type: none"><li>• Remove any metallic utensils, cookware, or metal ties. If using foil, use only narrow strips and allow at least one inch between the foil and interior oven walls.</li></ul>
<b>The turntable makes noises or sticks.</b>	<ul style="list-style-type: none"><li>• Clean the turntable, roller ring and oven floor.</li><li>• Make sure the turntable and roller ring are positioned correctly.</li></ul>
<b>Using your microwave causes tv or radio interference.</b>	<ul style="list-style-type: none"><li>• This is similar to the interference caused by other small appliances, such as hair dryers. Move your microwave further away from other appliances, like your TV or radio.</li></ul>



If the oven is set to cook for more than 25 minutes, it will automatically adjust itself to 70 percent power after 25 minutes to avoid overcooking.

## CARE AND CLEANING

---

- Follow these instructions to clean and care for your oven.
- Keep the inside of the oven clean. Food particles and spilled liquids can stick to the oven walls, causing the oven to work less efficiently.
- Wipe up spills immediately. Use a damp cloth and mild soap. Do not use harsh detergents or abrasives.
- To help loosen baked on food particles or liquids, heat two cups of water (add the juice of one lemon if you desire to keep the oven fresh) in a four-cup measuring glass at High power for five minutes or until boiling. Let stand in the oven for one or two minutes.
- Remove the glass tray from the oven when cleaning the oven or tray. To prevent the tray from breaking, handle it carefully and do not put it in water immediately after cooking. Wash the tray carefully in warm sudsy water or in the dishwasher.
- Clean the outside surface of the oven with soap and a damp cloth. Dry with a soft cloth. To prevent damage to the operating parts of the oven, don't let water seep into the openings.
- Wash the door window with very mild soap and water. Be sure to use a soft cloth to avoid scratching.
- If steam accumulates inside or outside the oven door, wipe with a soft cloth. Steam can accumulate when operating the oven in high humidity and in no way indicates microwave leakage.
- Never operate the oven without food in it; this can damage the magnetron tube or glass tray. You may wish to leave a cup of water in the oven when it is not in use to prevent damage if the oven is accidentally turned on.

## COOKTOP/NIGHT LIGHT REPLACEMENT

---

⚠ To avoid personal injury or property damage, wear gloves when replacing light bulb.

1. Unplug the oven or turn off power at the main power supply.
2. Remove the bulb cover, and mounting screws.
3. Replace bulb with 40 watt appliance bulb.
4. Replace bulb cover, and mounting screws.
5. Turn the power back on at the main power supply.

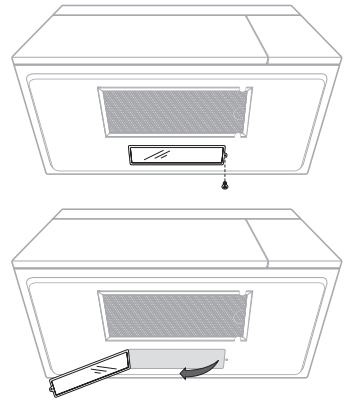

## OVEN LIGHT REPLACEMENT

---

1. Unplug oven or turn off power at the main power supply.
2. Open the door.
3. Remove the vent cover mounting screws. (3 middle screws)
4. Slide the grille to the left, then pull straight out.
5. Remove the charcoal filter, if present.
6. Touch and hold the center snap while lifting the tab on the left corner. Remove the cover. Remove the bulb by turning gently.
7. Replace bulb with a 40 watt appliance bulb.
8. Replace the bulb holder.
9. Replace the grille and 3 screws. Turn the power back on at the main power supply.

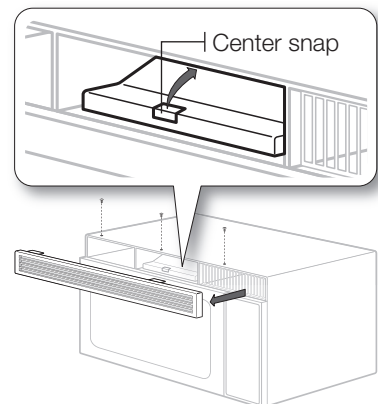

## CLEANING THE GREASE FILTER

---

The grease filter should be removed and cleaned often, at least once a month.

⚠ To avoid risk of personal injury or property damage, do not operate oven hood without filters in place.

1. To remove grease filter, slide filter to the side. Pull filter downward and push to the other side. The filter will drop out.

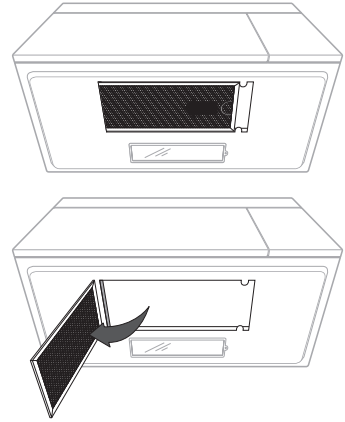

2. Soak grease filter in hot water and a mild detergent. Rinse well and shake to dry.

- **Do not use ammonia or place in a dishwasher. The aluminum will darken.**

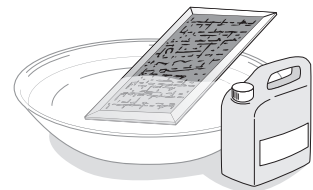

3. To reinstall the filter, slide it into the side slot, then push up and toward oven center to lock.

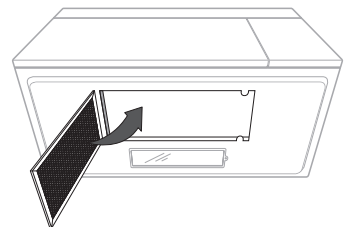

## CHARCOAL FILTER REPLACEMENT

If your oven is vented to the inside, the charcoal filter should be replaced every 6 to 12 months, and more often if necessary. The charcoal filter cannot be cleaned. To order a new charcoal filter, contact the Parts Department at your nearest Authorized Service Center or call: 1-800-SAMSUNG (7267864)

1. Unplug oven or turn off power at the main power supply.
2. Open the door.
3. Remove the vent grille mounting screws. (3 middle screws)
4. Slide the grille to the left, then pull straight out.
5. Push the hook and remove old filter.

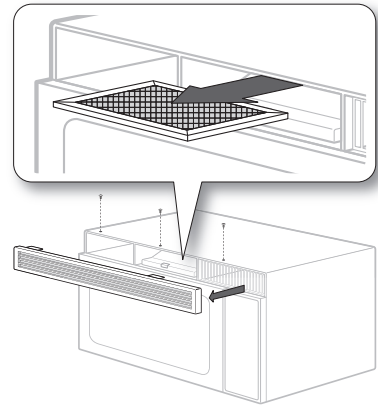

6. Slide a new charcoal filter into place. The filter should rest at the angle shown.
7. Replace the grille and 3 screws and close the door. Turn the power back on at the main power supply and set the clock.

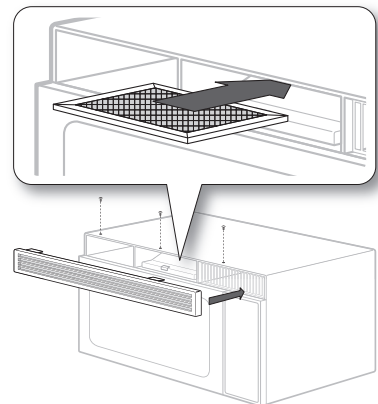

## SPECIFICATIONS

MODEL NUMBER	SMH5165STG
Oven Cavity	1.6 cuft
Controls	10 power levels, including defrost
Timer	99 minutes, 99 seconds
Power Source	120 VAC, 60 Hz
Power Consumption	1500 Watts
Power Output	900 Watts
Oven Cavity Dimensions	20 <sup>3</sup> / <sub>32</sub> "(W) X 9 <sup>3</sup> / <sub>8</sub> "(H) X 14 <sup>3</sup> / <sub>8</sub> "(D)
Outside Dimensions	29 <sup>7</sup> / <sub>8</sub> "(W) X 16 <sup>1</sup> / <sub>2</sub> "(H) X 15"(D)
Shipping Dimensions	33 <sup>3</sup> / <sub>8</sub> "(W) X 19 <sup>15</sup> / <sub>16</sub> "(H) X 19 <sup>13</sup> / <sub>32</sub> "(D)
Net/Gross Weight	45.4 / 54.3 lbs

## SAMSUNG OVER-THE-RANGE(OTR) MICROWAVE OVEN

### LIMITED WARRANTY TO ORIGINAL PURCHASER

This SAMSUNG brand product, as supplied and distributed by Samsung Electronics Canada, Inc. and delivered new, in the original carton to the original consumer purchaser, is warranted by SAMSUNG against manufacturing defects in materials and workmanship for a limited warranty period of:

#### **ONE (1) YEAR PARTS AND LABOR, TEN (10) YEARS PARTS WARRANTY FOR MAGNETRON**

This limited warranty begins on the original date of purchase, and is valid only on products purchased and used in the Canada. To receive warranty service, the purchaser must contact SAMSUNG for problem determination and service procedures. Warranty service can only be performed by a SAMSUNG authorized service center. The original dated bill of sale must be presented upon request as proof of purchase to SAMSUNG or SAMSUNG's authorized service center.

SAMSUNG will repair or replace this product, at our option and at no charge as stipulated herein, with new or reconditioned parts or products if found to be defective during the limited warranty period specified above. All replaced parts and products become the property of SAMSUNG and must be returned to SAMSUNG. Replacement parts and products assume the remaining original warranty, or ninety (90) days, whichever is longer.

In-home service will be provided during the warranty labor period subject to availability within the Canada. In-home service is not available in all areas. To receive in-home service, the product must be unobstructed and accessible to service personnel. If during in-home service repair can not be completed, it may be necessary to remove, repair and return the product. If in-home service is unavailable, SAMSUNG may elect, at our option, to provide for transportation of our choice to and from a SAMSUNG authorized service center. Otherwise, transportation to and from the SAMSUNG authorized service center is the responsibility of the purchaser.

This limited warranty covers manufacturing defects in materials and workmanship encountered in normal, noncommercial use of this product and shall not apply to the following, including, but not limited to: damage which occurs in shipment; delivery and installation; applications and uses for which this product was not intended; altered product or serial numbers; cosmetic damage or exterior finish; accidents, abuse, neglect, fire, water, lightning or other acts of nature; use of products, equipment, systems, utilities, services, parts, supplies, accessories, applications, installations, repairs, external wiring or connectors not supplied or authorized by SAMSUNG which damage this product or result in service problems; incorrect electrical line voltage, fluctuations and surges;

customer adjustments and failure to follow operating instructions, cleaning, maintenance and environmental instructions that are covered and prescribed in the instruction book; problems caused by pest infestations, and overheating or overcooking by user; glass tray or turntable; reduced magnetron power output related to normal aging. SAMSUNG does not warrant uninterrupted or error-free operation of the product.

THERE ARE NO EXPRESS WARRANTIES OTHER THAN THOSE LISTED AND DESCRIBED ABOVE, AND NO WARRANTIES WHETHER EXPRESS OR IMPLIED, INCLUDING, BUT NOT LIMITED TO, ANY IMPLIED WARRANTIES OF MERCHANTABILITY OR FITNESS FOR A PARTICULAR PURPOSE, SHALL APPLY AFTER THE EXPRESS WARRANTY PERIODS STATED ABOVE, AND NO OTHER EXPRESS WARRANTY OR GUARANTY GIVEN BY ANY PERSON, FIRM OR CORPORATION WITH RESPECT TO THIS PRODUCT SHALL BE BINDING ON SAMSUNG. SAMSUNG SHALL NOT BE LIABLE FOR LOSS OF REVENUE OR PROFITS, FAILURE TO REALIZE SAVINGS OR OTHER BENEFITS, OR ANY OTHER SPECIAL, INCIDENTAL OR CONSEQUENTIAL DAMAGES CAUSED BY THE USE, MISUSE OR INABILITY TO USE THIS PRODUCT, REGARDLESS OF THE LEGAL THEORY ON WHICH THE CLAIM IS BASED, AND EVEN IF SAMSUNG HAS BEEN ADVISED OF THE POSSIBILITY OF SUCH DAMAGES. NOR SHALL RECOVERY OF ANY KIND AGAINST SAMSUNG BE GREATER IN AMOUNT THAN THE PURCHASE PRICE OF THE PRODUCT SOLD BY SAMSUNG AND CAUSING THE ALLEGED DAMAGE. WITHOUT LIMITING THE FOREGOING, PURCHASER ASSUMES ALL RISK AND LIABILITY FOR LOSS, DAMAGE OR INJURY TO PURCHASER AND PURCHASER'S PROPERTY AND TO OTHERS AND THEIR PROPERTY ARISING OUT OF THE USE, MISUSE OR INABILITY TO USE THIS PRODUCT SOLD BY SAMSUNG NOT CAUSED DIRECTLY BY THE NEGLIGENCE OF SAMSUNG. THIS LIMITED WARRANTY SHALL NOT EXTEND TO ANYONE OTHER THAN THE ORIGINAL PURCHASER OF THIS PRODUCT, IS NONTRANSFERABLE AND STATES YOUR EXCLUSIVE REMEDY.

Some province do not allow limitations on how long an implied warranty lasts, or the exclusion or limitation of incidental or consequential damages, so the above limitations or exclusions may not apply to you. This warranty gives you specific legal rights, and you may also have other rights which vary from state to state.

To obtain warranty service, please contact SAMSUNG at:

**1-800-SAMSUNG (7267864) and [www.samsung.com/ca](http://www.samsung.com/ca)**



QUESTIONS OR COMMENTS?

COUNTRY	CALL	OR VISIT US ONLINE AT
IN CANADA	1-800-SAMSUNG (7267864)	<a href="http://www.samsung.com/ca">www.samsung.com/ca</a>