

SAMSUNG

MICROWAVE OVEN

Owner's Instructions and Cooking Guide

M1933N/M1913N

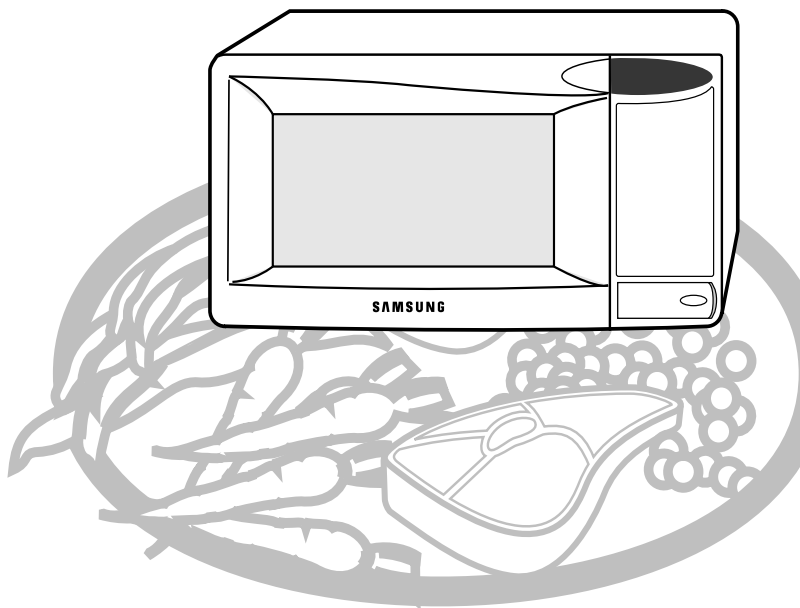

Quick Look-up Guide	2
Oven	3
Accessories	3
Control Panel.....	4
Using this Instruction Booklet.....	5
Safety Precautions	5
Installing Your Microwave oven	7
Setting the Time (M1933N)	7
How a Microwave Oven Works.....	8
Checking that Your Oven is Operating Correctly	8
What to Do if You are in Doubt or Have a Problem	9
Cooking / Reheating.....	9
Power Levels.....	10
Stopping the Cooking.....	10
Adjusting the Cooking Time	11
Manual Defrosting Food (M1913N).....	11
Using the Auto Defrost Feature (M1933N)	11
Auto Defrost Settings (M1933N)	12
Using the Instant Reheat/Cook Feature.....	12
Instant Reheat/Cook Settings	13
Multistage Cooking (M1933N).....	14
Switching the Beeper Off(M1933N)	15
Safety-Locking Your Microwave Oven(M1933N).....	15
Remembering Function (M1933N).....	15
Cookware Guide	16
Cooking Guide	17
Cleaning Your Microwave Oven	22
Storing and Repairing Your Microwave Oven.....	23
Technical Specification	23

Quick Look-up Guide

GB

Model: M1933N

If you want to cook some food

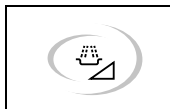

1. Place the food in the oven.
Select the power level by pressing the **1/20** button once or more times.

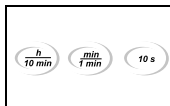

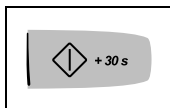

2. Select the cooking time by pressing the **10min**, **1min** or **10s** button as required.

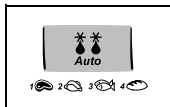

3. Press the  button.
Result : Cooking starts.
The oven beeps four times when cooking is over.

If you want to defrost some food



1. Place the frozen food in the oven.
Press the **Auto** () button once or more time according to the type of food to be defrosted. Refer to the table on the page 12 for further details.

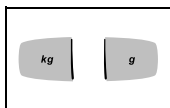

2. Select the weight by pressing the **kg** and **g** button as required.

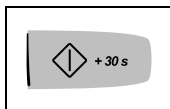

3. Press the  button.

If you want to add an extra 30 seconds

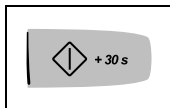

- Leave the food in the oven.
Press **+30s** once or more times for each extra 30 seconds that you wish to add.

Model: M1913N

If you want to cook some food

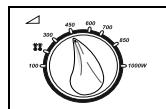

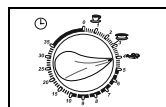

1. Place the food in the oven.
Select the power level by rotating the **COOKING POWER CONTROL** knob.

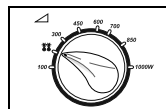

2. Select the cooking time by rotating the **TIMER** knob.

If you want to defrost some food



1. Turn the **COOKING POWER CONTROL** knob to defrost () symbol.

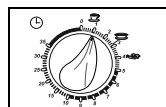

2. Turn the **TIMER** knob to select the appropriate time.

If you want to adjust the cooking time

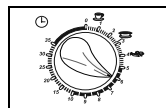

- Leave the food in the oven.
Turn the **TIMER** knob to desired time.

Oven

Model: M1933N

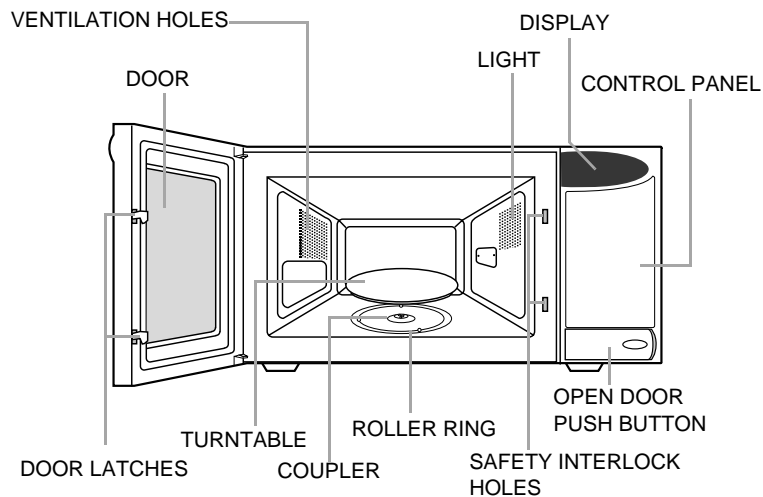

Model: M1913N

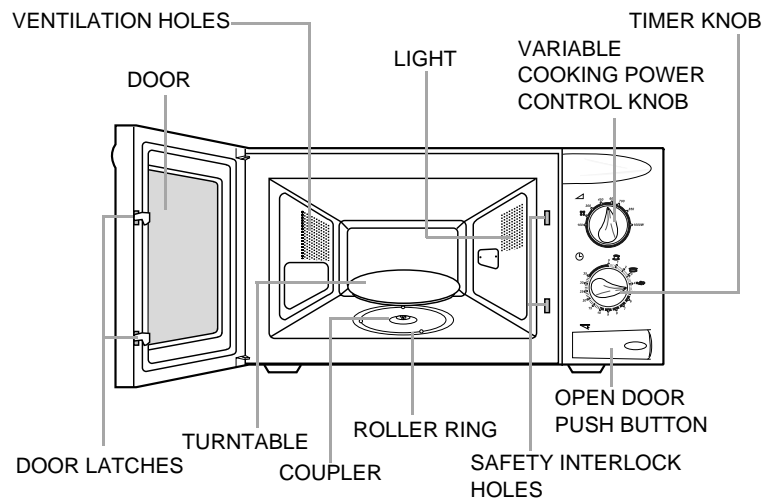

Accessories

Depending on the model that you have purchased, you are supplied with several accessories that can be used in a variety of ways.

GB

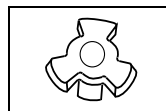

1. **Coupler**, already placed over the motor shaft in the base of the oven.

Purpose : The coupler rotates the turntable.

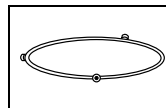

2. **Roller ring**, to be placed in the centre of the oven.

Purpose : The roller ring supports the turntable.

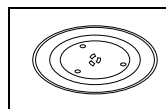

3. **Turntable**, to be placed on the roller ring with the centre fitting to the coupler.

Purpose : The turntable serves as the main cooking surface; it can be easily removed for cleaning.



DO NOT operate the microwave oven without the roller ring and turntable.

Control Panel

GB

Model:M1933N

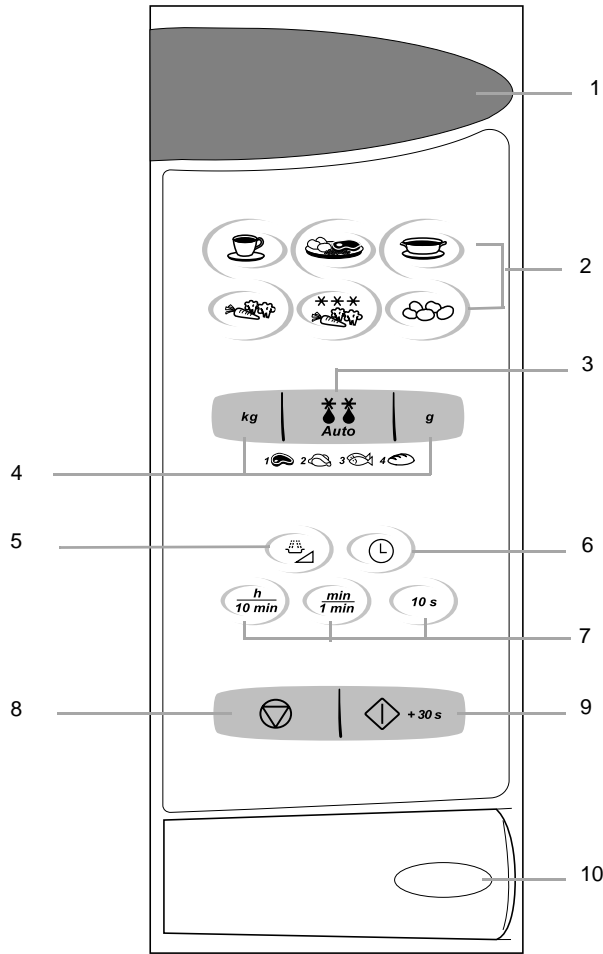

- | | |
|-----------------------------------|------------------------------|
| 1. DISPLAY | 5. MICRO WAVE MODE SELECTION |
| 2. INSTANT REHEAT/COOK SELECTION | 6. CLOCK SETTING |
| 3. AUTO DEFROST FEATURE SELECTION | 7. TIME SETTING |
| 4. WEIGHT SELECTION | 8. STOP/CANCEL BUTTON |
| | 9. START BUTTON |
| | 10. OPEN DOOR PUSH BUTTON |

Model:M1913N

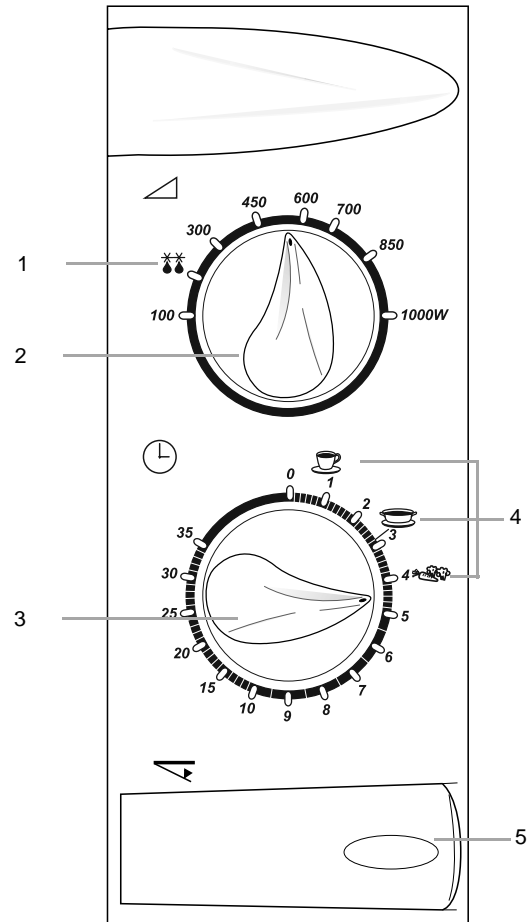

- | |
|-------------------------------|
| 1. DEFROST |
| 2. COOKING POWER CONTROL KNOB |
| 3. TIMER KNOB |
| 4. INSTANT REHEAT/COOK |
| 5. OPEN DOOR PUSH BUTTON |

Using this Instruction Booklet

You have just purchased a SAMSUNG microwave oven. Your Owner's Instructions contain much valuable information on cooking with your microwave oven:

- Safety precautions
- Suitable accessories and cookware
- Useful cooking tips

Inside the cover you will find a quick look-up guide explaining three basic cooking operations:

- Cooking food
- Defrosting food
- Adding extra cooking time

At the front of the booklet you will find illustrations of the oven, and more importantly the control panel, so that you can find the buttons more easily.

The step-by-step procedures use two different symbols.



Important



Note

PRECAUTIONS TO AVOID POSSIBLE EXPOSURE TO EXCESSIVE MICROWAVE ENERGY

Failure to observe the following safety precautions may result in harmful exposure to microwave energy.

- Under no circumstances should any attempt be made to operate the oven with the door open or to tamper with the safety interlocks (door latches) or to insert anything into the safety interlock holes.
- Do not place any object between the oven door and front face or allow food or cleaner residues to accumulate on sealing surfaces. Ensure that the door and door sealing surfaces are kept clean by wiping after use first with a damp cloth and then with a soft dry cloth.
- Do not operate the oven if it is damaged until it has been repaired by a qualified microwave service technician trained by the manufacturer. It is particularly important that the oven door closes properly and that there is no damage to the:
 - Door, door seals and sealing surfaces
 - Door hinges (broken or loose)
 - Power cable
- The oven should not be adjusted or repaired by anyone other than a properly qualified microwave service technician trained by the manufacturer.

Safety Precautions

Important Safety Instructions.

Read Carefully and keep for future reference.

Before cooking food or liquids in your microwave oven, please check that the following safety precautions are taken.

- DO NOT** use any metallic cookware in the microwave oven:
 - Metallic containers
 - Dinnerware with gold or silver trimmings
 - Skewers, forks, etc.

Reason: Electric arcing or sparking may occur and may damage the oven.
- DO NOT** heat:
 - Airtight or vacuum-sealed bottles, jars, containers
Ex) Baby food jars
 - Airtight food.
Ex) Eggs, nuts in shells, tomatoes

Reason: The increase in pressure may cause them to explode.
Tip: Remove lids and pierce skins, bags, etc.
- DO NOT** operate the microwave oven when it is empty.

Reason: The oven walls may be damaged.
Tip: Leave a glass of water inside the oven at all times.
The water will absorb the microwaves if you accidentally set the oven going when it is empty.
- DO NOT** cover the rear ventilation slots with cloths or paper.

Reason: The cloths or paper may catch fire as hot air is evacuated from the oven.
- ALWAYS** use oven gloves when removing a dish from the oven.

Reason: Some dishes absorb microwaves and heat is always transferred from the food to the dish. The dishes are therefore hot.
- DO NOT** touch heating elements or interior oven walls.

Reason: These walls may be hot enough to burn even after cooking has finished, even though they do not appear to be so. Do not allow inflammable materials to come into contact with any interior area of the oven. Let the oven cool down first.
- To reduce the risk of fire in the oven cavity:
 - Do not store flammable materials in the oven
 - Remove wire twist ties from paper or plastic bags
 - Do not use your microwave oven to dry newspapers
 - If smoke is observed, keep the oven door closed and switch off or disconnect the oven from the power supply

Safety Precautions (continued)

- GB
8. Take particular care when heating liquids and baby foods.
 - ALWAYS allow a standing time of at least 20 seconds after the oven has been switched off so that the temperature can equalize.
 - Stir during heating, if necessary, and ALWAYS stir after heating.
 - Take care when handling the container after heating. You may burn yourself if the container is too hot.
 - Take particular care when heating liquids and baby foods.
 - A risk of delayed eruptive boiling exists.
 - To prevent delayed boiling and possible scalding, you should put a plastic spoon or glass stick into the beverages and stir before, during and after heating.
Reason: During the heating of liquids the boiling point can be delayed; this means that eruptive boiling can start after the container is removed from the oven. You may scald yourself.
 - In the event of scalding, follow these FIRST AID instructions:
 - * Immerse the scalded area in cold water for at least 10 minutes.
 - * Cover with a clean, dry dressing.
 - * Do not apply any creams, oils or lotions.
 - NEVER fill the container to the top and choose a container that is wider at the top than at the bottom to prevent the liquid from boiling over. Bottles with narrow necks may also explode if overheated.
 - ALWAYS check the temperature of baby food or milk before giving it to the baby.
 - NEVER heat a baby's bottle with the teat on, as the bottle may explode if overheated.
 9. Be careful not to damage the power cable.
 - Do not immerse the power cable or plug in water and keep the power cable away from heated surfaces.
 - Do not operate this appliance if it has a damaged power cable or plug.
 10. Stand at arm's length from the oven when opening the door.
Reason: The hot air or steam released may cause scalding.
 11. Keep the inside of the oven clean.
Reason: Food particles or spattered oils stuck to oven walls or floor can cause paint damage and reduce the efficiency of the oven.
 12. You may notice a "Clicking" sound during operation (especially when the oven is in defrosting).
Reason: This sound is normal when the electrical power output is changing.
 13. When the microwave oven is operating without any load, the power will be cut off automatically for safety. You can operate normally after letting it stand for over 30 minutes.

IMPORTANT SAFETY INSTRUCTIONS

During cooking, you should look into the oven from time to time when food is being heated or cooked in disposable containers of plastic, paper or other combustible materials.

IMPORTANT

Young children should NEVER be allowed to use or play with the microwave oven. Nor should they be left unattended near the microwave oven when it is in use. Items of interest to children should not be stored or hidden just above the oven.

Installing Your Microwave oven

Place the oven on a flat, level surface that strong enough to safely bear the weight of the oven.

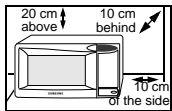

1. When you install your oven, Make sure there is adequate ventilation for your oven by leaving at least 10 cm (4 inches) of space behind, on the sides of the oven and 20 cm (8 inches) of above.
2. Remove all packing materials inside the oven. Install the roller ring and turntable. Check that the turntable rotates freely.
3. This microwave oven has to be positioned so that plug is accessible.

 **Never** block the air vents as the oven may overheat and automatically switch itself off. It will remain inoperable until it has cooled sufficiently.

 For your personal safety, plug the cable into a 3-pin, 230 Volt, 50Hz, AC earthed socket. If the power cable of this appliance is damaged, it must be replaced by a special cable (I-SHENG SP022, KDK KKP4819D, EUROELECTRIC 3410, SAMIL SP-106B, MOONSUNG EP-48E, HIGH PROJECT H.P 3). Contact your local dealer to have it replaced. The power cable of ISRAEL is PENCON(ZD16A), S/AFRICA APEX LEADS SA16 and NIGERIA, GHANA, KENYA and U.A.E is PENCON(UD13A1).

 **Do not** install the microwave oven in hot or damp surroundings like next to a traditional oven or radiator. The power supply specifications of the oven must be respected and any extension cable used must be of the same standard as the power cable supplied with the oven. Wipe the interior and the door seal with a damp cloth before using your microwave oven for the first time.

Setting the Time (M1933N)

Your microwave oven has an inbuilt clock. The time can be displayed in either the 24-hour or 12-hour notation. You must set the clock:

- **When you first install your microwave oven**
- **After a power failure**

 Do not forget to reset the clock when you switch to and from summer and winter time.

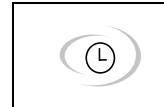

1. **To display the time in the...Then press the  button...**
24-hour notation Once
12-hour notation Twice

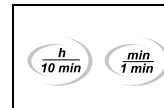

2. Set the hour with the **h** button and the minutes with the **min** button.

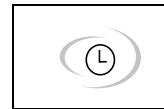

3. When the right time is displayed, press the  button again to start the clock.
Result : The time is displayed whenever you are not using the microwave oven

How a Microwave Oven Works

GB *Microwaves are high-frequency electromagnetic waves; the energy released enables food to be cooked or reheated without changing either the form or the colour.*

You can use your microwave oven to:

- Defrost
- Instant Reheat /Cook
- Cook

Cooking Principle

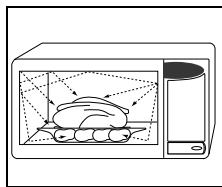

1. The microwaves generated by the magnetron are distributed uniformly as the food rotates on the turntable. The food is thus cooked evenly.
2. The microwaves are absorbed by the food up to a depth of about 1 inch (2.5 cm). Cooking then continues as the heat is dissipated within the food.
3. Cooking times vary according to the recipient used and the properties of the food:
 - Quantity and density
 - Water content
 - Initial temperature (refrigerated or not)



As the centre of the food is cooked by heat dissipation, cooking continues even when you have taken the food out of the oven. Standing times specified in recipes and in this booklet must therefore be respected to ensure:

- Even cooking of the food right to the centre
- The same temperature throughout the food

Checking that Your Oven is Operating Correctly

The following simple procedure enables you to check that your oven is working correctly at all times.

First, place a bowl of water on the turntable. Then, close the door.

Model: M1933N

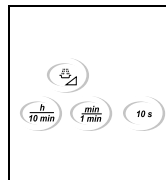

1. Press the  button and set the time to 4-5 minutes by pressing the **1min** button the appropriate number of times.

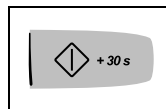

2. Press the  button.
Result: The oven heats the water for 4 to 5 minutes. The water should then be boiling.

Model: M1913N

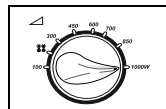

1. Set the power level to maximum by turning **COOKING POWER CONTROL** knob.





2. Set the time 4 to 5 minutes by turning the **TIMER** knob. The water should then be boiling.



The oven must be plugged into an appropriate wall socket. The turntable must be in position in the oven. If a power level other than the maximum is used, the water takes longer to boil.

What to Do if You are in Doubt or Have a Problem

If you have any of the problems listed below try the solutions given.

- ◆ This is normal.
 - Condensation inside the oven
 - Air flow around the door and outer casing
 - Light reflection around the door and outer casing
 - Steam escaping from around the door or vents
 - ◆ The oven does not start when you press the  button.(M1933N)
 - Is the door completely closed?
 - ◆ The oven does not start when you turn the **TIMER** knob.(M1913N)
 - Is the door completely closed?
 - ◆ The food is not cooked at all
 - Have you set the timer correctly and/or pressed the  button?(M1933N)
 - Have you set the timer correctly? (M1913N)
 - Is the door closed?
 - Have you overloaded the electric circuit and caused a fuse to blow or a breaker to be triggered?
 - ◆ The food is either overcooked or undercooked
 - Was the appropriate cooking length set for the type of food?
 - Was an appropriate power level chosen?
 - ◆ Sparking and cracking occur inside the oven (arcing)
 - Have you used a dish with metal trimmings?
 - Have you left a fork or other metal utensil inside the oven?
 - Is aluminium foil too close to the inside walls?
 - ◆ The oven causes interference with radios or televisions
 - Slight interference may be observed on televisions or radios when the oven is operating. This is normal. To solve this problem, install the oven away from televisions, radios and aerials.
 - If interference is detected by the oven's microprocessor, the display may be reset. To solve this problem, disconnect the power plug and reconnect it. Reset the time. (M1933N)
-  If the above guidelines do not enable you to solve the problem, contact your local dealer or SAMSUNG after-sales service.



Cooking / Reheating

The following procedure explains how to cook or reheat food. **ALWAYS check your cooking settings before leaving the oven unattended.**

First, place the food in the centre of the turntable. Then, close the door.

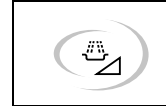
Model: M1933N



1. Press the  button.
Result : The 1000W (maximum cooking power) indications are displayed:
Select the appropriate power level by pressing the  button again until the corresponding wattage is displayed. Refer to the power level table on the next page.

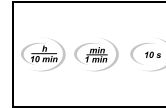

2. Set the cooking time by pressing the **10min**, **1min** and **10s** button.

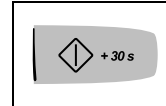

3. Press the  button.
Result : The oven light comes on and the turntable starts rotating. When it has finished:
 - 1) The oven beeps four times.
 - 2) The end reminder signal will beep 3 times. (once every minute)
 - 3) The current time is displayed again.



Never switch the microwave oven on when it is empty.



If you wish to heat a dish for a short period of time at maximum power (1000W), simply press the **+30s** button once for each 30 seconds of cooking time. The oven starts immediately.

Model: M1913N

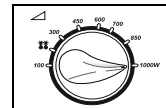

1. Set the power level to maximum by turning **COOKING POWER CONTROL** knob. (**MAXIMUM POWER: 1000 W**)

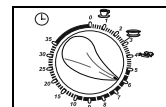

2. Set the time by turning **TIMER** knob.
Result : The oven light comes on and the turntable starts rotating.



Never switch the microwave oven on when it is empty.



You can change the power level during cooking by turning the **COOKING POWER CONTROL** knob.

Power Levels

You can choose among the power levels below.

Power Level	Output	
	M1933N	M1913N
FULL	1000 w	1000 w
HIGH	850 W	850 W
REHEAT	-	700 W
MEDIUM HIGH	600 W	600 W
MEDIUM	450 W	450 W
MEDIUM LOW	300 W	300 W
DEFROST(♦♦)	180 W	180 W
LOW	100 W	100 W

- ☒ If you select higher power level, the cooking time must be decreased.
- ☒ If you select lower power level, the cooking time must be increased.

Stopping the Cooking

You can stop cooking at any time to check the food.

Model: M1933N

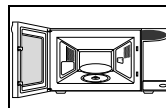

1. To stop temporarily;
Open the door.
Result : Cooking stops. To resume cooking, close the door and press ◊ again.

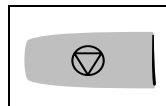

2. To stop Completely;
Press the ▾ button.
Result : The cooking stops.
If you wish to cancel the cooking settings, press the ▾ button again.



You can cancel any setting before starting cooking by simply pressing ▾.

Model: M1913N

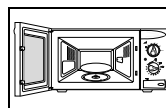

1. To stop temporarily;
Open the door.
Result : Cooking stops. To resume cooking, close the door.



2. To stop Completely;
Turn the **TIMER** knob to "0".

Adjusting the Cooking Time

Model: M1933N

You can increase the cooking time by pressing the +30s button once for each 30 seconds to be added.

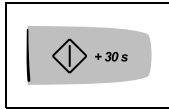

Press the **+30s** button once for each 30 seconds to be added.

Model: M1913N

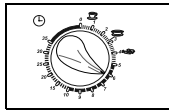

Adjust the remaining cooking time by rotating the **TIMER** knob.

Manual Defrosting Food (M1913N)

The Defrost feature enables you to defrost meat, poultry, fish, fruit or bread.

First, place the frozen food in the centre of the turntable. Then, close the door..

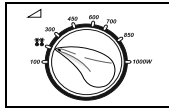

1. Turn the **COOKING POWER CONTROL** knob to .



2. Turn the **TIMER** knob to select the appropriate time.
Result : Defrosting begins.

Use only recipients that are microwave-safe.

Using the Auto Defrost Feature (M1933N)

The Auto Defrost feature enables you to defrost meat, poultry, fish or bread cake. The defrost time and power level are set automatically.

You simply select the programme and the weight.

Use only dishes that are microwave-safe.

First, place the frozen food in the centre of the turntable. Then, close the door.

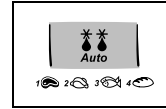

1. Press the **Auto**() button.
Press the **Auto**() button once or more times according to the type of food to be defrosted. Refer to the table on the next page for further details.

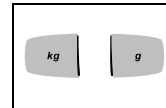

2. Select the food weight by pressing the **kg** and **g** button.
It is possible to set up to a maximum of 2.0kg.

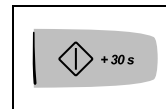

3. Press button.

Result :





- ◆ Defrosting begins.
- ◆ The oven beeps halfway through defrosting to remind you to turn the food over.
- ◆ Press again to finish defrosting.

You can also defrost food manually. To do so, select the microwave cooking/reheating function with a power level of 180W. Refer to the section entitled "Cooking/Reheating" on page 9 for further details.

Auto Defrost Settings (M1933N)

The following table presents the various Auto Defrost programmes, quantities, standing times and appropriate recommendations.

Remove all kinds of package material before defrosting. Place meat, poultry and fish on a turntable.

Food	Serving Size	Standing Time	Recommendations
 Meat	0.2-2 kg	20-60 mins	Shield the edges with aluminium foil. Turn the meat over, when the oven beeps. This programme is suitable for beef, lamb, pork, steaks, chops, minced meat.
 Poultry	0.2-2 kg	20-60 mins	Shield the leg and wing tips with aluminium foil. Turn the poultry over, when the oven beeps. This programme is suitable for whole chicken as well as for chicken portions.
 Fish	0.2-2 kg	20-50 mins	Shield the tail of a whole fish with aluminium foil. Turn the fish over, when the oven beeps. This programme is suitable for whole fishes as well as for fish fillets.
 Bread/ Cake	125-1000 g	5-30 mins	Put bread on a piece of kitchen paper and turn over, as soon as the oven beeps. Place cake on a ceramic plate and if possible, turn over, as soon as the oven beeps. (Oven keeps operating and is stopped, when you open the door.) This programme is suitable for all kinds of bread, sliced or whole, as well as for bread rolls and baguettes. Arrange bread rolls in a circle. This programme is suitable for all kinds of yeast cake, biscuit, cheese cake and puff pastry. It is not suitable for short/crust pastry, fruit and cream cakes as well as for cake with chocolate topping.

Using the Instant Reheat/Cook Feature

Model: M1933N

With the Instant Reheat and Cook feature, the cooking time is set automatically and you do not have to press the  button. You can adjust the number of servings by pressing the appropriate Instant Reheat and Cook button the required number of times.

First, place the food in the centre of the turntable and close the door.



Press the **Instant Reheat** and **Cook** button which you want the required number of times.

Result : Cooking starts after about two seconds.

- When it has finished:
- 1) The oven beeps four times.
 - 2) The end reminder signal will beep 3 times. (once every minute)
 - 3) The current time is displayed again.

Example: Press the  button three times to reheat three cups of coffee. Refer to the table on the next page.

 Use only recipients that are microwave-safe.

Model: M1913N

First, place the food in the center of the turntable and close the door.

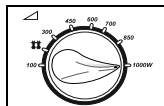

1. Turn the **COOKING POWER CONTROL** knob to Max Power.

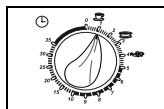





2. Turn the **TIMER** knob to select Instant Reheat. (drinks, soup/sauce or fresh vegetables).

 Use only recipients that are microwave-safe.

Instant Reheat/Cook Settings

Model: M1933N

The following table presents the various Instant Reheat and Cook Programmes, serving size, standing times and appropriate recommendations.



Food/Button	Serving Size	Standing Time	Recommendations
Ready Meal Chilled 	300-350 g 400-450 g	3 mins	Put on a ceramic plate and cover with microwave cling film. This programme is suitable for meals consisting of 3 components (e.g. meat with sauce, vegetables and a side dish like potatoes, rice or pasta).
Drinks (coffee, milk, tea, water with room temperature) 	150 ml (1 cup) 300 ml (2 cups) 450 ml (3 cups) 600 ml (4 cups)	1-2 mins	Pour into a ceramic cup and reheat uncovered. Place 1 cup in the centre, 2 opposite of each other and 3 or 4 in a circle. Stir carefully before and after standing time, be careful while taking them out of oven.
Soup/Sauce Chilled 	200 - 250 ml 300 - 350 ml 400 - 450 ml 500 - 550 ml 600 - 650 ml	2-3 mins	Pour into a deep ceramic soup plate or bowl and cover during heating and standing. Stir carefully before and after standing time.
Peeled Potatoes 	200 - 250 g 300 - 350 g 400 - 450 g 500 - 550 g 600 - 650 g 700 - 750 g	3 mins	Weigh the potatoes after peeling, washing and cutting into a similar size. Put them into a glass bowl with lid. Add 45 ml (3 tablespoons) water when cooking 200-450 g, add 60 ml (4 tablespoons) for 500-650 g and add 75 ml (5 tablespoons) for 700-750 g.

Frozen vegetables 	100 - 150 g	3 mins	Weigh the frozen vegetables (-18°C) and put them in a suitable sized glass pyrex bowl with lid. When cooking 100-450 g add 15 ml (1 tablespoon) water for 500-750 g add 30 ml (2 tablespoons). Stir after cooking and during standing time. When cooking bigger quantities stir once during cooking. This programme is suitable for peas, sweet corn, broccoli, cauliflower and mixed vegetables such as peas, carrots and cauliflower.
	200 - 250 g		
	300 - 350 g		
	400 - 450 g		
	500 - 550 g		
	600 - 650 g		
700 - 750 g			

Fresh vegetables 	100 - 150 g	3 mins	Weigh the vegetables after washing, cleaning and cutting into a similar size. Put them into a glass bowl with lid. Add 30 ml (2 tablespoons) water when cooking 100-250 g, add 45 ml (3 tablespoons) for 300-450 g and add 60-75 ml (4-5 tablespoons) for 500-750 g. Stir after cooking. (When cooking bigger quantities, stir once during cooking.)
	200 - 250 g		
	300 - 350 g		
	400 - 450 g		
	500 - 550 g		
	600 - 650 g		
700 - 750 g			

Model: M1913N

Here are a few tips and recommendations to be followed when cooking or reheating food with the Instant Reheat and Cook and Cooking Feature.

Symbols	Food	Serving Size	Cooking Time	Standing Time
	Drinks	150 ml	1 min	1-2 mins
	Soup/Sauce	200-250 ml	2 min 50 sec	2-3 mins
	Fresh vegetables	300-350 g	4 min	3 mins

GB

Multistage Cooking (M1933N)

GB

Your microwave oven can be programmed to cook food in up to three stages.

Example: You wish to defrost food and cook it without having to reset the oven after each stage. You can thus defrost and cook a 500g fish in three stages:

- **Defrosting**
- **Cook I**
- **Cook II**

☒ You can set between two and three stages in multistage cooking.

☒ If you set three stage, the first stage must be defrosting.

☒ Don't press  button until you've set the final stage.

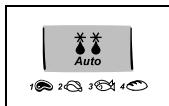

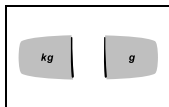

1. Press the **Auto** () button once or more times (fish in the example).



2. Set the weight by pressing the **kg** and **g** buttons the appropriate number of times (500g in the example).



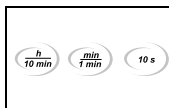

3. Press the  button.
The microwave mode(I):
 ; if necessary, set the power level by pressing the  button again one or more times. (850W in the example)



4. Set the cooking time by pressing the **10min**, **1min** and **10s** buttons the appropriate number of times (4 minutes in the example).



7. Press the  button.
The microwave mode(II):
 ; if necessary, set the power level by pressing the  button again one or more times. (450W in the example)

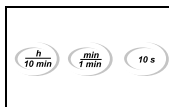

8. Set the cooking time by pressing the **10min**, **1min** and **10s** buttons the appropriate number of times (5 minutes in the example).

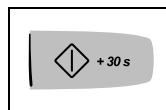

9. Press the  button.



Result : The three modes [defrosting and cooking(I,II)] are selected on after. According to the defrosting mode that you have chosen, the oven may beep half way through defrosting to remind you to turn the food over.

- ◆ When it has finished:
 - 1) The oven beeps four times.
 - 2) The end reminder signal will beep 3 times. (once every minute)
 - 3) The current time is displayed again.

Switching the Beeper Off(M1933N)

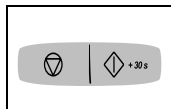

You can switch the beeper off whenever you want.

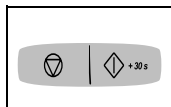

1. Press the  and  buttons at the same time.
Result: The oven will not beep each time you press a button.

OFF



2. To switch the beeper back on, press the  and  buttons again at the same time.
Result: The oven operates with the beeper on again.



On

Safety-Locking Your Microwave Oven(M1933N)

Your microwave oven is fitted with a special Child Safety programme, which enables the oven to be “locked” so that children or anyone unfamiliar with it cannot operate it accidentally.

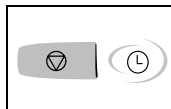

The oven can be locked at any time.

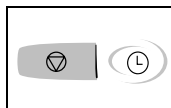

1. Press the  and  buttons at the same time.
Result: The oven is locked (no functions can be selected).

L



2. To unlock the oven, press the  and  buttons again at the same time.
Result: The oven can be used normally.

Remembering Function (M1933N)

This oven remembers the last cooking mode for your convenience.

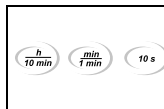

1. Add some cooking time using the **10min**, **1min** and **10s** buttons.

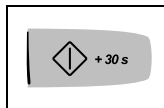

2. Press the  button.

NOTE

- 1) When cooking is over, the end reminder signal will beep 3 times (once every minute). And then, cooking mode will be “RESET” and the oven will forget the last cooking mode.
- 2) If there's no operation after the door is opened and closed once, the cooking mode will be “RESET” after 30 seconds.
- 3) Press the  button and then cooking mode will be “RESET”.

Cookware Guide

GB

To cook food in the microwave oven, the microwaves must be able to penetrate the food, without being reflected or absorbed by the dish used.

Care must therefore be taken when choosing the cookware. If the cookware is marked microwave-safe, you do not need to worry.

The following table lists various types of cookware and indicates whether and how they should be used in a microwave oven.

Cookware	Microwave-Safe	Comments
Aluminium foil	✓ X	Can be used in small quantities to protect areas against overcooking. Arcing can occur if the foil is too close to the oven wall or if too much foil is used.
Browning plate	✓	Do not preheat for more than eight minutes.
China and earthenware	✓	Porcelain, pottery, glazed earthenware and bone china are usually suitable, unless decorated with a metal trim.
Disposable polyester cardboard dishes	✓	Some frozen foods are packaged in these dishes.
Fast-food packaging		
• Polystyrene cups containers	✓	Can be used to warm food. Overheating may cause the polystyrene to melt.
• Paper bags or newspaper	X	May catch fire.
• Recycled paper or metal trims Glassware	X	May cause arcing.
Glassware		
• Oven-to-table ware	✓	Can be used, unless decorated with a metal trim.
• Fine glassware	✓	Can be used to warm foods or liquids. Delicate glass may break or crack if heated suddenly.
• Glass jars	✓	Must remove the lid. Suitable for warming only.

Metal			
• Dishes	X		May cause arcing or fire.
• Freezer bag twist ties	X		
Paper			
• Plates, cups, napkins and Kitchen paper	✓		For short cooking times and warming. Also to absorb excess moisture.
• Recycled paper	X		May cause arcing.
Plastic			
• Containers	✓		Particularly if heat-resistant thermoplastic. Some other plastics may warp or discolour at high temperatures. Do not use Melamine plastic.
• Cling film	✓		Can be used to retain moisture. Should not touch the food. Take care when removing the film as hot steam will escape.
• Freezer bags	✓ X		Only if boilable or oven-proof. Should not be airtight. Prick with a fork, if necessary.
Wax or grease-proof paper	✓		Can be used to retain moisture and prevent spattering.

Cooking Guide

MICROWAVES

Microwave energy actually penetrates food, attracted and absorbed by its water, fat and sugar content. The microwaves cause the molecules in the food to move rapidly. The rapid move-ment of these molecules creates friction and the resulting heat cooks the food.

COOKING

Cookware for microwave cooking:

Cookware must allow microwave energy to pass through it for maximum efficiency. Microwaves are reflected by metal, such as stainless steel, aluminium and copper, but they can penetrate through ceramic, glass, porcelain and plastic as well as paper and wood. So food must never be cooked in metal containers.

Foods suitable for microwave cooking:

Many kinds of food are suitable for microwave cooking, including fresh or frozen veg-etables, fruit, pasta, rice, grains, beans, fish, and meat. Sauces, custard, soups, steamed puddings, preserves, and chutneys can also be cooked in a microwave oven. Generally speaking, microwave cooking is ideal for any food that would normal-ly be prepared on a hob. Melting butter or chocolate, for example (see the chapter with special hints).

Covering during cooking

It is very important to cover the food during cooking because evaporated water rises as steam and contributes to the cooking process. Food can be covered in different ways: e.g. with a ceramic plate, plastic cover or microwave suitable cling film.

Standing times

It is important to allow standing time when you have finished cooking the food in order to allow the temperature within the food to even out.

Cooking Guide for frozen vegetables

Use a suitable glass pyrex bowl with lid. Cook covered for the minimum time - see table. Continue cooking to get the result you prefer.

Stir twice during cooking and once after cooking. Add salt, herbs or butter after cooking. Cover during standing time.

Food	Portion	Power	Time (min.)	Standing Time (min.)	Instructions
Spinach	300g	600W	10-11	2-3	Add 15 ml (1 tablespoon) cold water.
Broccoli	300g	600W	9-10	2-3	Add 15 ml (1 tbsp.) cold water.
Peas	300g	600W	8-9	2-3	Add 15 ml (1 tbsp.) cold water.
Green Beans	300g	600W	8½-9½	2-3	Add 15 ml (1 tbsp.) cold water.

Food	Portion	Power	Time (min.)	Standing Time (min.)	Instructions
Mixed Vegetables (carrots/peas/corn)	300g	600W	8-9	2-3	Add 15 ml (1 tbsp.) cold water.
Mixed Vegetables (Chinese style)	300g	600W	9-10	2-3	Add 15 ml (1 tbsp.) cold water.

Cooking Guide for rice and pasta

Rice : Use a large glass pyrex bowl with lid - rice doubles in volume during cook ing. Cook covered.
After the cooking time is over, stir before standing time and salt or add herbs and butter.
Remark: the rice may not have absorbed all water after the cooking time is finished.

Pasta : Use a large glass pyrex bowl. Add boiling water, a pinch of salt and stir well. Cook uncovered.
Stir occasionally during and after cooking. Cover during standing time and drain thoroughly afterwards.

Food	Portion	Power	Time (min.)	Standing Time (min.)	Instructions
White Rice (parboiled)	250g 375g	1000W	14-15 16½-17½	5	Add 500 ml cold water. Add 750 ml cold water.
Brown Rice (parboiled)	250g 375g	1000W	19-20 21-22	5-10	Add 500 ml cold water. Add 750 ml cold water.
Mixed Rice (rice + wild rice)	250g 375g	1000W	15-16 17½-18½	5	Add 500 ml cold water. Add 750 ml cold water.
Mixed Corn (rice + grain)	250g 375g	1000W	16-17 20-21	5-10	Add 400 ml cold water. Add 550 ml cold water.
Pasta	250g 500g	1000W	10-11 12-14	5	Add 1000 ml hot water. Add 2000 ml hot water.

Cooking Guide(continued)

Cooking Guide for fresh vegetables

Use a suitable glass pyrex bowl with lid. Add 30-45 ml cold water (2-3 tbsp.) for every 250 g unless another water quantity is recommended - see table. Cook covered for the minimum time - see table. Continue cooking to get the result you prefer. Stir once during and once after cooking. Add salt, herbs or butter after cooking. Cover during a standing time of 3 minutes.

Hint: Cut the fresh vegetables into even sized pieces. The smaller they are cut, the quicker they will cook.

All fresh vegetables should be cooked using full microwave power (1000 W).

Food	Portion	Time (min.)	Standing Time (min.)	Instructions
Broccoli	250g 500g	4-4½ 7½-8	3	Prepare even sized florets. Arrange the stems to the centre.
Brussels Sprouts	250g	6-6½	3	Add 60-75 ml (5-6 tbsp.) water.
Carrots	250g	4½-5	3	Cut carrots into even sized slices.
Cauliflower	250g 500g	5-5½ 8-8½	3	Prepare even sized florets. Cut big florets into halves. Arrange stems to the centre.
Courgettes	250g	4-4½	3	Cut courgettes into slices. Add 30 ml (2 tbsp.) water or a knob of butter. Cook until just tender.
Egg Plants	250g	3-3½	3	Cut egg plants into small slices and sprinkle with 1 tablespoon lemon juice.
Leeks	250g	4-4½	3	Cut leeks into thick slices.
Mushrooms	125g 250g	1½-2 2½-3	3	Prepare small whole or sliced mushrooms. Do not add any water. Sprinkle with lemon juice. Spice with salt and pepper. Drain before serving.
Onions	250g	4½-5	3	Cut onions into slices or halves. Add only 15 ml (1 tbsp.) water.
Pepper	250g	4-4½	3	Cut pepper into small slices.
Potatoes	250g 500g	4½-5½ 7½-8½	3	Weigh the peeled potatoes and cut them into similar sized halves or quarters.
Turnip Cabbage	250g	5-5½	3	Cut turnip cabbage into small cubes.

Cooking Guide for fresh fish

Use the power level and times in this table as guide lines for cooking.

Food	Portion	Power	Time (min.)	Standing Time (min.)	Instructions
Fish Fillets	200 g 400 g	600 W	3½-4½ 6-7	3-5	Rinse with water, sprinkle with lemon juice and put the fish fillets on a flat glass pyrex plate. Cover with microwave cling film. Stand for 3-5 minutes.
Whole Fish	350 g(1) 700 g(2)	600W	4½-5½ 8-10	3-5	Rinse with water, sprinkle with lemon juice and put the fish in an oval glass pyrex dish(2 fishes head to tail). Cover with microwave cling film during cooking and standing time. Stand for 3-5 minutes.

REHEATING

Your microwave oven will reheat food in a fraction of the time that conventional ovens and hobs normally take.

Use the power levels and reheating times in the following chart as a guide. The times in the chart consider liquids with a room temperature of about +18 to +20°C or a chilled food with a temperature of about +5 to +7°C.

Arranging and covering

Avoid reheating large items such as joint of meat - they tend to overcook and dry out before the centre is piping hot. Reheating small pieces will be more successful.

Power levels and stirring

Some foods can be reheated using 1000 W power while others should be reheated using 850W, 600 W, 450 W or even 300 W.

Check the tables for guidance. In general, it is better to reheat food using a lower power level, if the food is delicate, in large quantities, or if it is likely to heat up very quickly (mince pies, for example).

Stir well or turn food over during reheating for best results. When possible, stir again before serving.

Take particular care when heating liquids and baby foods. To prevent eruptive boiling of liquids and possible scalding, stir before, during and after heating. Keep them in the microwave oven during standing time. We recommend putting a plastic spoon or glass stick into the liquids. Avoid overheating (and therefore spoiling) the food.

It is preferable to underestimate cooking time and add extra heating time, if necessary.

Heating and standing times

When reheating food for the first time, it is helpful to make a note of the time taken - for future reference.

Always make sure that the reheated food is piping hot throughout.

Allow food to stand for a short time after reheating - to let the temperature even out. The recommended standing time after reheating is 2-4 minutes, unless another time is recommended in the chart..

Take particular care when heating liquids and baby food. See also the chapter with the safety precautions.

REHEATING LIQUIDS

Always allow a standing time of at least 20 seconds after the oven has been switched off to allow the temperature to even out. Stir during heating, if necessary, and ALWAYS stir after heating. To prevent eruptive boiling and possible scalding, you should put a spoon or glass stick into the beverages and stir before, during and after heating.

REHEATING BABY FOOD

BABY FOOD:

Empty into a deep ceramic plate. Cover with plastic lid. Stir well after reheating! Let stand for 2-3 minutes before serving. Stir again and check the temperature. Recommended serving temperature: between 30-40°C.

BABY MILK:

Pour milk into a sterilised glass bottle. Reheat uncovered. Never heat a baby's bottle with teat on, as the bottle may explode if overheated. Shake well before standing time and again before serving! Always carefully check the temperature of baby milk or food before giving it to the baby.

- Recommended serving temperature: ca. 37°C.

REMARK:

Baby food particularly needs to be checked carefully before serving to prevent burns. Use the power levels and times in the next table as guide lines for reheating. The times in the chart consider baby milk and food with a room temperature of about +18°C to +20°C.

Reheating Frozen Food

Use the power levels and times in this table as guide lines for reheating..

Food	Portion	Power	Time (min.)	Standing Time (min.)	Instructions
Pasta (frozen)	400g	600W	15-17	3	Put frozen pasta, for example tortellini or ravioli in a flat glass pyrex dish. Cover with plastic lid. Stir occasionally during cooking and before standing.
Meat pieces in sauce (frozen)	450g	600W	14-16	3	Put frozen meal (e.g. chicken curry) in a flat glass dish as cover. Stir occasionally during cooking and before standing.
Soup (frozen)	500g	850W	12-14	3	Put frozen soup in a suitable sized glass pyrex dish with lid. Cook covered. Stir occasionally during cooking and before standing.
Yeast Dumpling (frozen)	150g 300g	600W	2-3 3-4	3	Put 2-4 frozen yeast dumplings side by side in a big glass pyrex bowl with lid. Moist the top of dumplings with cold water. Cook covered.

Cooking Guide(continued)

Reheating Baby Food and Milk

Use the power levels and times in this table as guide lines for reheating..

Food	Portion	Power	Time (min.)	Standing Time (min.)	Instructions
Baby food (vegetables + meat)	190g	600W	30 sec.	2-3	Empty into ceramic deep plate. Cook covered. Stir after cooking time. Stand for 2-3 minutes. Before serving, stir well and check the temperature carefully.
Baby porridge (grain + milk + fruit)	190g	600W	20 sec.	2-3	Empty into ceramic deep plate. Cook covered. Stir after cooking time. Stand for 2-3 minutes. Before serving, stir well and check the temperature carefully.
Baby milk	100ml 200ml	300W	30-40 sec. 1 min 10 sec. -1 min 20 sec.	2-3	Stir or shake well and pour into a sterilised glass bottle. Place into the centre of turn-table. Cook uncovered. Shake well and stand for at least 2 minutes. Before serving, shake well and check the temperature carefully.

Reheating Liquids and Food

Use the power levels and times in this table as guide lines for reheating.

Food	Portion.	Power	Time (min.)	Standing Time (min.)	Instructions
Drinks (coffee, milk, tea, water with room temperature)	150 ml (1 cup)	1000W	1-1½	1-2	Pour into a ceramic cup and reheat uncovered. Place 1 cup in the centre, 2 opposite of each other and 3 or 4 in a circle. Stir carefully before and after standing time, be careful while taking them out of oven.
	300 ml (2 cups)		1½-2		
	450 ml (3 cups)		2½-3		
	600 ml (4 cups)		3½-4		
Soup (chilled)	350g 450g 550g	1000W	3-4 3½-4½ 4-5	2-3	Pour into a deep ceramic plate. Cover with plastic lid. Stir well after reheating. Stir again before serving.
Stew (chilled)	350g	600W	4½-5½	2-3	Put stew in a deep ceramic plate. Cover with plastic lid. Stir occasionally during reheating and again before standing and serving.
Pasta with sauce (chilled)	350g	600W	3½-4½	3	Put pasta (e.g. spaghetti or egg noodles) on a flat ceramic plate. Cover with microwave cling film. Stir before serving.
Filled pasta with sauce (chilled)	350g	600W	4-5	3	Put filled pasta (e.g. ravioli, tortellini) in a deep ceramic plate. Cover with plastic lid. Stir occasionally during reheating and again before standing and serving.
Plated Meal (chilled)	350g 450g 550g	600W	4½-5½ 5½-6½ 6½-7½	3	Plate a ready-to heat meal of 2-3 chilled components on a ceramic dish. Cover with microwave cling-film.

Cooking Guide(continued)

DEFROSTING

Microwaves are an excellent way of defrosting frozen food. Microwaves gently defrost frozen food in a short period of time. This can be of great advantage, if unexpected guests suddenly show up.

Frozen poultry must be thoroughly thawed before cooking. Remove any metal ties and take it out of any wrapping to allow thawed liquid to drain away.

Put the frozen food on a dish without cover. Turn over halfway, drain off any liquid and remove any giblets as soon as possible.

Check the food occasionally to make sure that it does not feel warm. If smaller and thinner parts of the frozen food start to warm up, they can be shield by wrapping very small strips of aluminium foil around them during defrosting.

Should poultry start to warm up on the outer surface, stop thawing and allow it to stand for 20 minutes before continuing.

Leave the fish, meat and poultry to stand in order to complete defrosting. The standing time for complete defrosting will vary depending on the quantity defrosted. Please refer to the table below.

Hint: Flat food defrosts better than thick and smaller quantities need less time than bigger ones. Remember this hint while freezing and defrosting food. For defrosting of frozen food with a temperature of about -18 to -20 °C, use the following table as a guide.

All frozen food should be defrosted using defrosting power level (180W, ½).

Food	Portion	Time (min.)	Standing Time (min.)	Instructions
Meat				
Minced beef	200g 400g	7½ - 8½ 14 - 16	5-20	Place the meat on a flat ceramic plate. Shield thinner edges with aluminium foil. Turn over after half of defrosting time!
Pork steaks	250g	8½ - 9½		
Poultry				
Chicken pieces	500g (2 pc)	17 - 18	15-60	First, put chicken pieces first skin-side down, whole chicken first breast-side-down on a flat ceramic plate. Shield the thinner parts like wings and ends with aluminium foil. Turn over after half of defrosting time!
Whole chicken	900g	28 - 30		

Food	Portion	Time (min.)	Standing Time (min.)	Instructions
Fish				
Fish fillets	200g (2 pc) 400g (4 pc)	7-8 14 - 15	5-20	Put frozen fish in the middle of a flat ceramic plate. Arrange the thinner parts under the thicker parts. Shield narrow ends with aluminium foil. Turn over after half of defrosting time!
Fruits				
Berries	250g	8 - 9	5 - 15	Distribute fruits on a flat, round glass dish (with a large diameter).
Bread				
Bread rolls (each ca. 50 g) Toast/ Sandwich	2 pc 4 pc 250g	1½ - 2 3 - 3½ 6 - 6½	5 - 10	Arrange rolls in a circle or bread vertically(like a tower) on kitchen paper in the middle of turntable. Turn over after half of defrosting time!

GB

Cooking Guide(continued)

SPECIAL HINTS

MELTING BUTTER

Put 50 g butter into a small deep glass dish. Cover with plastic lid. Heat for 30-40 seconds using 1000 W, until butter is melted.

MELTING CHOCOLATE

Put 100 g chocolate into a small deep glass dish. Heat for 3-5 minutes, using 450W until chocolate is melted. Stir once or twice during melting. Use oven gloves while taking out!

MELTING CRYSTALLIZED HONEY

Put 20 g crystallized honey into a small deep glass dish. Heat for 20-30 seconds using 300 W, until honey is melted.

MELTING GELATINE

Lay dry gelatine sheets (10 g) for 5 minutes into cold water. Put drained gelatine into a small glass pyrex bowl. Heat for 1 minute using 300 W. Stir after melting.

COOKING GLAZE/ICING (FOR CAKE AND GATEAUX)

Mix instant glaze (approximately 14 g) with 40 g sugar and 250 ml cold water. Cook uncovered in a glass pyrex bowl for 3½ to 4½ minutes using 1000 W, until glaze/icing is transparent. Stir twice during cooking.

COOKING JAM

Put 600 g fruits (for example mixed berries) in a suitable sized glass pyrex bowl with lid. Add 300 g preserving sugar and stir well. Cook covered for 10-12 minutes using 1000 W. Stir several times during cooking. Empty directly into small jam glasses with twist-off lids. Stand on lid for 5 minutes.

COOKING PUDDING

Mix pudding powder with sugar and milk (500 ml) by following the manufacturers instructions and stir well. Use a suitable sized glass pyrex bowl with lid. Cook covered for 6½ to 7½ minutes using 1000 W. Stir well several times during cooking.

BROWNING ALMOND SLICES

Spread 30 g sliced almonds evenly on a medium sized ceramic plate. Stir several times during browning for 3½ to 4½ minutes using 600 W. Let it stand for 2-3 minutes in the oven. Use oven gloves while taking out!

Cleaning Your Microwave Oven

The following parts of your microwave oven should be cleaned regularly to prevent grease and food particles from building up:

- *Inside and outside surfaces*
- *Door and door seals*
- *Turntable and Roller rings*



ALWAYS ensure that the door seals are clean and the door closes properly.

1. Clean the outside surfaces with a soft cloth and warm, soapy water. Rinse and dry.
2. Remove any splashes or stains on the inside surfaces or on the roller ring with a soapy cloth. Rinse and dry.
3. To loosen hardened food particles and remove smells, place a cup of diluted lemon juice on the turntable and heat for ten minutes at maximum power.
4. Wash the dishwasher-safe plate whenever necessary.



DO NOT spill water in the vents. **NEVER** use any abrasive products or chemical solvents. Take particular care when cleaning the door seals to ensure that no particles:

- Accumulate
- Prevent the door from closing correctly

Storing and Repairing Your Microwave Oven

A few simple precautions should be taken when storing or having your microwave oven serviced.

The oven must not be used if the door or door seals are damaged:

- Broken hinge
- Deteriorated seals
- Distorted or bent oven casing

Only a qualified microwave service technician should perform repair.

- ✎ **NEVER** remove the outer casing from the oven. If the oven is faulty and needs servicing or you are in doubt about its condition:
 - Unplug it from the wall socket
 - Contact the nearest after-sales service centre

- ☒ If you wish to store your oven away temporarily, choose a dry, dust-free place.
 - **Reason:** Dust and damp may adversely affect the working parts in the oven.

- ☒ This microwave oven is not intended for commercial use.

Technical Specification

SAMSUNG strives to improve its products at all times. Both the design specifications and these user instructions are thus subject to change without notice.

Model	M1933N / M1913N
Power source	230V ~ 50 Hz
Power consumption Microwave	1400 W
Output power	100 W / 1000 W (IEC-705)
Operating frequency	2450 MHz
Magnetron	OM75P(31)
Cooling method	Cooling fan motor
Dimensions (W x H x D) Outside Oven cavity	517 x 297 x 379 mm 336 x 241 x 349 mm
Volume	28 liter
Weight Net	16 kg approx

GB

