

SAMSUNG

24V DC

MICROWAVE OVEN

Installation and Owner's Manual

DE6612

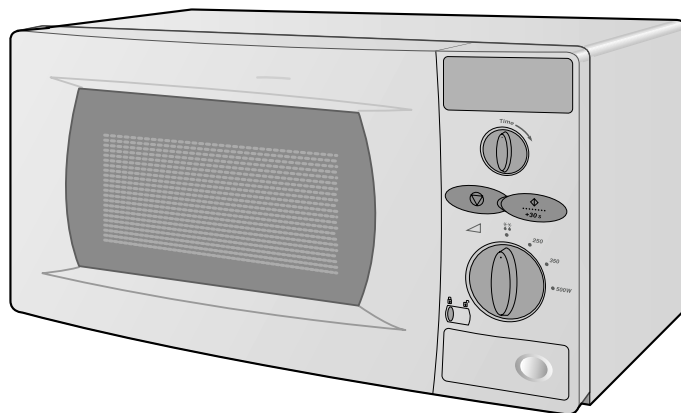

Safety	2
Important Safety Instructions	2
General Safety Requirements	3
Microwave oven Installation Requirements	4
Requirements	4
Supplied Items	4
Items needed for Installation	4
Installation	4
Safety Requirements for Installation:.....	5
Electrical Wiring	5
Battery	5
Connecting the Power Cables to the Oven	6
Battery Power Consumption for proper operation	6
Your New Microwave oven	6
Checking Parts	6
Thank You for Choosing Samsung	6
Setting Up Your Microwave Oven	7
Control Panel	7
Operation	8
Setting Cooking Times	8
Power Levels	8
Using the Cancel (⏏) Button	8
Using the Start (▶) +30 s Button	9
Error Codes	9
Cooking Guide	9
Cooking Instruction	10
Cooking Utensils	10
Testing Utensils	10
Cooking Techniques	10
General Tips	11
Appendix	11
Troubleshooting Guide	11
Care and Cleaning.....	12
Specifications	12



PRECAUTIONS TO AVOID POSSIBLE EXPOSURE TO EXCESSIVE MICROWAVE ENERGY:

- (a) Do not attempt to operate this oven with the door open since open-door operation can result in harmful exposure to microwave energy. It is important not to defeat or tamper with the safety interlocks.
- (b) Do not place any object between the front face of the oven and the door or allow soil or cleaner residue to accumulate on sealing surfaces.
- (c) Do not operate the oven if it is damaged. It is particularly important that the oven door close properly and that there is no damage to the
 - 1) Door (bent or dented),
 - 2) Hinges and latches (broken or loosened),
 - 3) Door seals and sealing surfaces.
- (d) The oven should not be adjusted or repaired by anyone except properly qualified service personnel.



WARNING

Always observe Safety Precautions when using your oven. Never try to repair the oven on your own – there is dangerous voltage inside. If the oven needs to be repaired, call SAMSUNG- for the name of an authorized service center near you.

IMPORTANT SAFETY INSTRUCTIONS

When using any electrical appliance, basic safety precautions should be followed, including the following:



WARNING

To reduce risk of burns, electric shock, fire, personal injury or exposure to excessive microwave energy:

- Read all safety instructions before using the appliance.
- Read and follow the specific “Precautions to avoid exposure to excessive microwave energy” on this page.
- Install or place this appliance only in accordance with the installation instructions provided.

- Some items, like whole eggs and food in sealed containers, may explode if heated in this oven.
- Use this appliance only for its intended use as described in the manual. Do not use corrosive chemicals or vapors in this appliance. This type of oven is specifically designed to heat, cook, or dry food. It is not designed for industrial or laboratory use.
- **IMPORTANT SAFETY INSTRUCTIONS**
 - * During cooking, you should look into the oven from time to time when food is being heated or cooked in disposable containers of plastic, paper or other combustible materials.
- **IMPORTANT**
 - * Young children should NEVER be allowed to use or play with the microwave oven. Nor should they be left unattended near the microwave oven when it is in use. Items of interest to children should not be stored or hidden just above the oven.
- Do not operate this appliance if it has a damaged Power cable, if it is not working properly, or if it has been damaged or dropped.
- This appliance should be serviced only by qualified service personnel. Contact the nearest authorized service facility for examination, repair, or adjustment.
- Do not cover or block any of the openings on this appliance.
- Do not store this appliance outdoors. Do not use near water – for example, near a kitchen sink, in a wet basement, or near a swimming pool, etc.
- Keep the inside of the oven clean. Food particles or spattered oils stuck to the oven walls or floor can cause paint damage and reduce the efficiency of the oven.
- Do not immerse power cable in water.
- Keep power cable away from heated surfaces.
- When cleaning door and oven surfaces, use only mild, nonabrasive soaps or detergents applied with a sponge or soft cloth.
- To reduce the risk of fire in the oven:
 - * Do not overcook food. Watch appliance carefully if paper, plastic, or other combustible materials are inside.
 - * Remove wire twist-ties from paper or plastic cooking bags before placing bags in oven.
 - * Do not use the oven compartment for storage purposes. Do not leave paper products, cooking utensils, or food in the oven when not in use.
- Do not try to preheat oven or operate while empty.
- Do not cook without the glass tray in place on the oven floor. Food will not cook properly without the tray.

Important Safety Instructions, continued

- Do not defrost frozen beverages in narrow necked bottles. The containers can break.
- Dishes and containers can become hot. Handle with care.
- Carefully remove container coverings, directing steam away from hands and face.
- Do not operate any other heating or cooking appliance beneath appliance.
- Do not mount unit over or near any portion of a heating or cooking appliance.
- DO NOT use any metallic cookware in the microwave oven:
 - * Metallic containers
 - * Dinnerware with gold or silver trimmings
 - * Skewers, forks, etc.
- DO NOT heat:
 - * Airtight or vacuum-sealed bottles, jars, containers
Ex) Baby food jars
 - * Airtight food.
Ex) Eggs, nuts in shells, tomatoes
- Take particular care when heating liquids and baby foods.
 - * ALWAYS allow a standing time of at least 20 seconds after the oven has been switched off so that the temperature can equalize.
 - * Stir during heating, if necessary, and ALWAYS stir after heating.
 - * Take care when handling the container after heating. You may burn yourself, if the container is too hot.
 - * A risk of delayed eruptive boiling exists.
To prevent delayed boiling and possible scalding, you should put a plastic spoon or glass stick into the beverages and stir before, during and after heating.
 - * NEVER fill the container to the top and choose a container that is wider at the top than at the bottom to prevent the liquid from boiling over. Bottles with narrow necks may also explode if overheated.
 - * ALWAYS check the temperature of baby food or milk before giving it to the baby.
 - * NEVER heat a baby's bottle with the teat on, as the bottle may explode if overheated.

WARNING

Safety Requirements: If safety requirements are not followed, it may result in an injury or a damage to the appliance.

Precaution! **Safety Requirements**

If safety requirements are not followed, it may result in a damage to the appliance or malfunction.

Read the Owner's Manual carefully before using the microwave oven.

The Owner's Manual includes valuable information necessary not only for your safety, but also for appliance maintenance.

General Safety Requirements

- If the oven is not going to be in use for a long period of time, disconnect it and store it in a cool, well ventilated place.
- If the oven is going to be used and stored by another person, be sure to include the Owner's Manual along with the microwave oven.
- This appliance is equipped with a capacitor. Therefore, when relocating the oven, be sure to first disconnect the battery, wait 20 seconds, then disconnect the power cable connections.
- Do not operate the oven if it does not work properly. Be sure to disconnect the battery from the oven to prevent an injury or damage to the appliance.
- The oven is only for cooking or boiling.
- Only qualified service personnel trained specifically by the manufacturer should repair this appliance.
- Do not attempt to repair the oven yourself.
- Keep the oven out of the reach of children.
- When installing the oven in a vehicle, ask a installation specialist for help.

Microwave oven Installation Requirements

GB

Requirements

The requirements for proper microwave oven operation are as follows:

- Operating Voltage: 24V DC.
- Breaking Voltage: Min. 21.5V, Max. 29.5V.
- Battery life must be at least 45Ah at 24V .

If possible, connect the oven to a separate supply battery (a secondary battery).

Supplied Items

Microwave oven, Turntable, Terminal Post Cover (plastic cover), Install bracket(Left/Right), 6-#5 Tap screws, 7-#4 screws and Owner's Manual. The battery connection power cable is not included.

Items needed for Installation

Before installing the appliance, make sure you have the following items:

- 6-#5 Tap screws (The length of the screw is subject to the installation requirements.)
- 7-#4 Tap screws (Outer panel screws).
- 2 connection power cables : one red, one black(refer to the page 6 for the length and size of the connection cables)
- Power cable terminal, power cable binder, and electrical tape.
- Depending on the installation location, the following tools may be required.
- Stick ruler, chalk, hammer, and gimlet.
- Drill and borer.
- Ring/Fork type spanner set.
- Crimp pincers, soldering iron.
- Screw driver.

Installation

Installation Location Tips

- Before installing the oven, be sure to comply with the following: The installation location for the oven should be even, flat, and sturdy.
- Do not allow humidity or heat to affect the oven.
- Allow free space of about 50mm around the oven for ventilation (Fig.1).

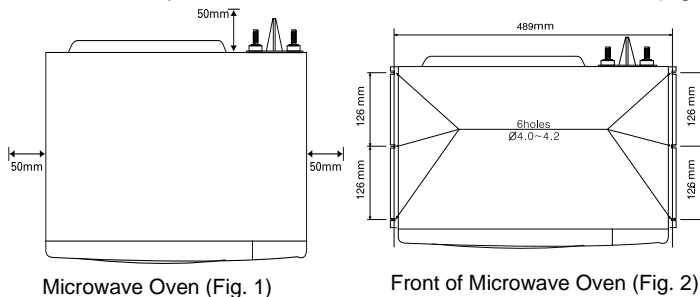

- Take the oven's weight into account. Check whether any protective measure such as a large support base is necessary or not.
- To determine hole location, refer to the dimensions in Fig. 2 and follow the instructions.

WARNING

When installing the oven in a vehicle, make sure that the installation location is safe enough to avoid an injury. (including a vehicle's sudden stop or accident).

- To make a hole in an accurate location, create a mark in advance with a hammer and punch. Smooth any rough edges on the holes and apply rust proof treatment to them.
 - Remove one screw securing outer panel of microwave oven (Right side).
 - Attach left and right brackets to the outer panel using 8 screws(Fig.1).
 - Secure the microwave oven brackets to the frame which has drilled holes(\varnothing 4.0~4.2) using 6 screws (Tap Screws).(Fig.2).
 - Fig.3 shows how the microwave should look attached to the frame.

If the electrical wiring does not work after the oven is fastened tightly, first follow the "Electrical Wiring (Page 5-6)" instructions and then re-fasten the oven.

- The oven must be fastened tightly to protect against vibration.

If do not want to use brackets, please attach 8 screws (#4x12) on left and right side of the outer panel directly.(Fig.4)

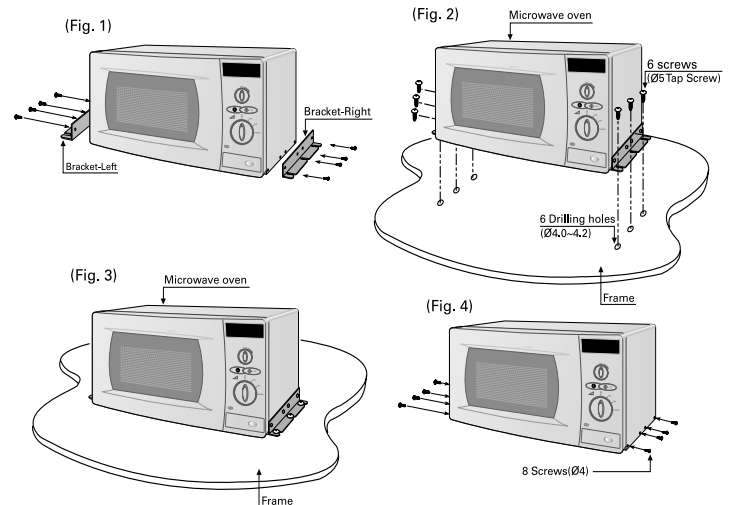

Microwave oven Installation Requirements (continued)

GB

Safety Requirements for Installation:

The operating voltage should comply with the voltage specified in the label of the microwave oven type attached to the back of the appliance.

WARNING

This appliance is equipped with a capacitor. To remove or relocate the appliance, take the battery out and wait for about 20 seconds, and then disconnect the power cable connections. If the power cable is disconnected too soon, it may cause an electrical short circuit and discharge (spark).

The operating voltage should comply with the voltage specified in the microwave oven type label on the back of the appliance.

It is a good idea to install an additional safety fuse to a positive(+) power cable. If the connection power cable is damaged or causes a short circuit, it means that the safety fuse can no longer prevent the appliance from being damaged (cable fire). The safety fuse should be installed as close to the battery as possible.

If the electrical cabling is not performed properly, it may cause an electrical short circuit, resulting in the following:

- Power cable may catch fire.
- Airbag may burst.
- Controller may work improperly.
- An electrical component may malfunction. (Signal lamp, Brake lamp, Horn, Ignition, Lighting, etc.).

To eliminate the danger of an electrical short circuit, always disconnect and isolate the battery negative terminal before using an electrical device in the vehicle. Also, in the case of a vehicle equipped with an additional battery, disconnect and isolate the negative(-) battery power cable.

Precaution

When disconnecting and isolating the negative battery power cable, all the data stored in the memory of the vehicle's system will disappear.

Depending on equipment included in your vehicle, you may have to enter the following data again:

Ex) Vehicle audio password, vehicle clock, seat location, panel computer, and time switch.

Electrical Wiring

Connection Power Cable

- Do not pull the power cable forcibly.
- Do not connect to a power supply other than 24V.
- Comply with the minimum diameter of the power cable as specified in the manual.
- Fasten the power cable properly.
- Install the power cable properly to prevent tripping over it.
- Install the power cable properly to prevent damage.
- Use one red (positive/+) and one black (negative/-) power cable to avoid confusion.

Battery

WARNING

- Improper connection of power cable wires (+, - polarity) causes the main fuse or safety fuse to disconnect in the microwave oven. Be sure to connect +, - polarity in the proper way.
- Connect the power cable securely.

If not, the oven may not function correctly and could cause damage to the vehicle. Be sure to connect the cable with proper torque (30~50kg.cm) Connect the oven to the user's battery (a secondary battery) if possible. Connecting to the starter battery may overload the appliance, which in turn may cause the engine to not turn over.

- Make sure there is sufficient Battery Capacity. The battery capacity should be at least 45Ah for 24V operating voltage.

Power Cable Size and Power Cable Length

For a 3m wire, the size should be a minimum 22mm² (4AWG) for 24V of operating voltage.

- For a power cable more than 3m in length, the size must be larger in order to reduce the voltage drop.

If the voltage drop is too much, the oven may not operate properly.

- If you have used the microwave oven for longer than 10 minutes, keep your vehicle's engine running for 2~3 minutes to avoid battery drain.

Microwave oven Installation Requirements (continued)

GB

Connecting the Power Cables to the Oven

- Install the power cable clamp required for the battery connection to the connection power cable. Do not connect the power cable to the battery yet.
- Bring the power cable close to the oven.
- Remove two nuts attached to the power connector on the rear of the oven.
- Connect each ring terminal end of the power cable wire to the bolt of power connector on the oven.
- Be careful not to damage the wire.
- Tighten each ring terminal end with the nut.
- Be sure to attach the positive power cable (Battery +) to the red right insulating terminal on the oven.
- Be sure to attach the negative power cable (Battery -) to the black left terminal.
- Connect the positive power cable (Battery +) to the battery first. Then, connect the negative power cable (Battery -) to the battery.
- In case of uninstalling the power cable, do it in exactly reverse order.

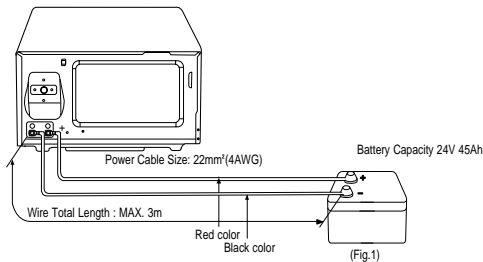

Battery Power Consumption for proper operation

Microwave oven will operate continuously for a maximum of 30 minutes of the battery.

The battery life is subject to various conditions such as battery operating hours, battery charging status, ambient temperature, etc.

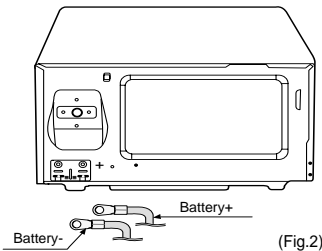

Your New Microwave oven

Checking Parts

Unpack your microwave oven and check to make sure that you have all the parts shown here. If any part is missing or broken, call your dealer.

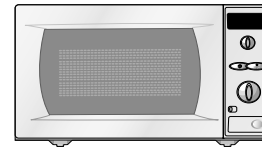

microwave oven



Owner's manual

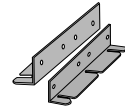

install bracket
(left/right)



glass tray



installation screws
(6-#5 Tap screws)



outer panel screws
(7-#4 screws)



roller guide ring

Thank You for Choosing Samsung

Your new oven represents the latest in microwave cooking technology. This oven is a full-featured, easy-to-use appliance built to strict quality standards set by Samsung - the highest in the industry. We're proud to offer you a product that will provide convenient, dependable service for years to come.

Please record the serial number from the inside or back of your Samsung microwave oven and the date of purchase in the space provided below.

We recommend that you keep your purchase receipt with this manual for easy warranty service.

Model Number _____
 Serial Number _____
 Date Purchased _____
 Dealer _____

Your New Microwave oven(continued)

Setting Up Your Microwave Oven

1. Once connected to the power supply the display on your oven will show:



Make sure there is adequate ventilation for your oven by leaving at least 50mm of space behind, above, and to the side of the oven.

2. Open the oven door by pressing the button below the control panel.
3. Wipe the inside of the oven with a damp cloth.
4. Place the pre-assembled ring in the indentation in the center of the oven.

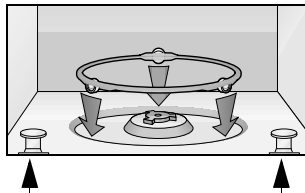

Holding stick
(a device which prevents the glass tray from its bounce).

5. Place the glass tray on top of the ring so that the three glass tabs in the center of the tray fit securely into the tabs on the floor of the oven.

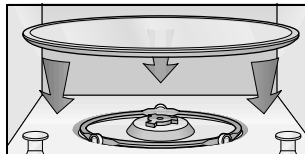

Precaution

- Never operate the oven if the vehicle is experiencing violent movement.
- Operating the oven in a fast moving vehicle is not recommended.
- Ensure that the spillage is kept to a minimum by using an appropriate container.

Control Panel

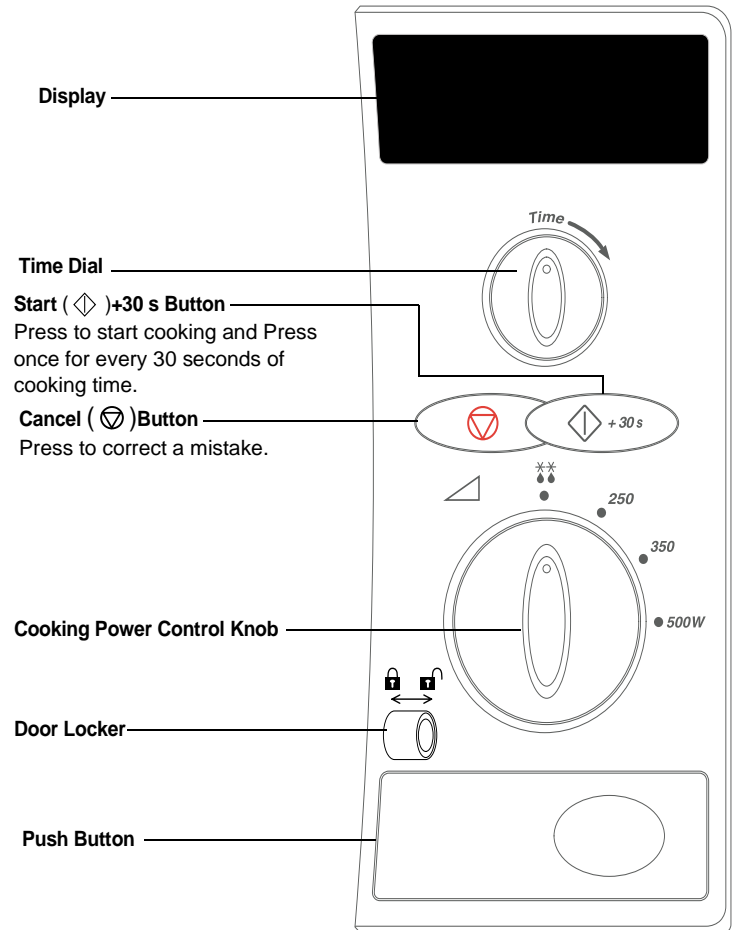

Operation

GB



Setting Cooking Times

This following procedure explains how to cook or reheat food.

Always check your cooking settings before leaving the oven unattended.

1. Once connected to the power supply the display on your oven will show : 8888.
2. Unlock by keeping the door's lock to the right.
3. Open the door.
The oven light will turn on.
4. Put the food into a suitable container, place it in the center of the oven and then close the door securely. The oven light will go off.
5. Set the power level by turning the Cooking Power Control Knob as required. (Maximum power : 500W)
The display on your oven will show the required power level for a moment. (For setting in 500W, P500)
6. Set the cookign time by turning the **Time Dial**, and then cooking start automatically after about three seconds.
The oven light and cooling fan will come on. Heating will start. The time on the digital display will count down.

NOTE

- Press the **Start** ()+30s button if you want to operate the oven before automatically.
 - Whenever the oven is operating, cooking time is increased by turning to the right and decreased by turning to the left.
 - You can change the power level by turning the Cooking Power Control Knob during heating.
 - If you close it after opening the door during heating, the oven will not operate. Press the **Start** ()+30s button for operating the oven.
7. When time has elapsed, the Beep Tone will sound 3 times and all heating will stop. The oven light will go off.
 8. Open the door and take the food out.
 9. Close the door. The oven light will go off.
 10. Lock the door by keeping the door's lock to the left.

NOTE

- The oven light and all numbers in the display automatically turn off after 5 minutes to conserve battery power.
- Setting time cannot exceed the maximum of 30 minutes.

WARNING

Be sure to lock the door by keeping it to the left for the sake of safety except that the oven is operating.

Important Remark

Voltage supply of the microwave oven is limited to protect the safety of product and vehicle

1. If the battery voltage goes below 21V when operating the oven or 21.5V when the oven is idle, the oven beeps 6 times and "Lo" blinks on the display.
2. If the battery voltage is low, you can check to see if it has returned to normal by pressing the Cancel button. If a blinking period (.) appears, the voltage has returned to normal and you can use the oven again.
3. If the battery voltage goes above 28.5V when operating the oven or 29.5V when the oven is idle, the oven beeps 6 times and "HI" blinks on the display.
4. If the battery voltage is high, you can check to see if it has returned to normal by pressing the Cancel button. If a blinking period (.) appears, the voltage has returned to normal and you can use the oven again.

Power Levels

You can choose between the power levels below.

Power Level	Output
HIGH	500W
MEDIUM HIGH	350W
MEDIUM	250W
DEFROST()	150W

NOTE

- If you select the higher power level, the cooking time must be decreased.
- If you select the lower power level, the cooking time must be increased.



When you set the cooking time by turning **Time Dial**.

Time	Increasing time
Up to 1 min.	5 sec. unit
1 -3 min.	10 sec. unit
3 -10 min.	30 sec. unit
10 -20 min.	1 min. unit
20 -30 min.	2 min. unit

NOTE

- If you want to add the cooking time by turning **Time Dial**, turn to the right (Increasing time : 10 sec.).

Using the Cancel () Button

- To stop cooking, erase instructions, and return the oven display to period(+): press **Cancel** () Button.
- To correct a mistake you have just entered: press **Cancel** () once, then re-enter the instructions.

Operation (continued)

Using the Start() +30 s Button

This is a ONE TOUCH COOK pad.



By touching the pad once, you can start heating instantly for 30 seconds.

You can increase the cooking time by pressing the **Start() +30 s** button during heating.











Cooking time increases by 30 seconds button with each press of the **Start() +30 s** button, but it can not exceed the maximum time of 30 minutes.

Like traditional cooking, you may find that you have to adjust the cooking times slightly. You can:

- Check how cooking is progressing at any time simply by opening the door.
- After checking, close the door.
- Increase the remaining cooking time if necessary.

Before operating the oven, times can be increased using either the time pads or **Start() +30 s** button. During operation, time may only be added by using the **Start() +30 s** button.

Error Codes

Error Items	Code	Cause/Remedy
Low Voltage		Low Batt. Voltage/Check the Batt. (Min. 21.5V)
High Voltage		High Batt. Voltage/Check the Batt. (Max. 29.5V)
No Acknowledge		EEPROM(internal memory IC) error/ Call service center
Check-sum Error		
Thermistor Short		Thermistor Sensor failure/ Call service center
Thermistor Open		
No current		<ul style="list-style-type: none"> • No current or over current. • Press the Cancel () button.
Over current		<ul style="list-style-type: none"> • Press the Start()+30s button after setting up cooking time. • Call Service Center (Displaying three times continuous "nC" or "oC").

Error Beep is 6 times.

Cooking Guide

Use the power level and time in this table as a guideline for cooking.

Food	Portion	Power	Time (min.)	Standing Time (min.)	instructions
Bread Rolls (frozen)	(each ca.50g) 2 pcs 4 pcs	150W	2-2 ½ 3-3½	5-10	Arrange rolls in a circle on kitchen paper in the middle of turntable. Turn over after half of defrosting time!
Pizza; Slice (chilled)	(each ca. 100g) 1pc 2pcs	250W	2-2 ½ 3½-4	1-2	Arrange pieces of pizza side by side on kitchen paper on a ceramic plate (do not turnover).
Pasta (chilled)	350g	350W	6-7	2-3	Put the pasta (e.g. spaghetti or egg noodles) on a flat ceramic plate. Cover with microwave cling film. Stir before serving.
Popcorn	100g	500W	Ca. 3½	-	Put the popcorn bag in the centre of turntable after removing plastic wrap.
Drinks (coffee, tea and water)	250ml (1 mug) 500 ml (2 mugs)	500W	2-2 ½ 3½-4	1-2	Pour into cups and reheat uncovered:Put the mug in the centre of turntable.Keep in microwave oven during standing time and stir well.
Ready Meal	400g	500W	5½-6½	4	Put the dish with ready meal of 2-3 components on the turntable.After reheating stand for 4 min.

Cooking Utensils

Recommended Use

- **Glass and glass-ceramic bowls and dishes** — Use for heating or cooking.
- **Microwave browning dish** — Use to brown the exterior of small items such as steaks, chops, or pancakes. Follow the directions provided with your browning dish.
- **Microwavable plastic wrap** — Use to retain steam. Leave a small opening for some steam to escape and avoid placing it directly on the food.
- **Wax paper** — Use as a cover to prevent spattering.
- **Paper towels and napkins** — Use for short-term heating and covering; they absorb excess moisture and prevent spattering. Do not use recycled paper towels, which may contain metal and can catch fire.
- **Paper plates and cups** — Use for short-term heating at low temperatures. Do not use recycled paper, which may contain metal and can catch fire.
- **Thermometers** — Use only those labeled “Microwave Safe” and follow all directions. Check the food in several places. Conventional thermometers may be used once the food has been removed from the oven.

Limited Use

- **Aluminum foil** — Use narrow strips of foil to prevent overcooking of exposed areas. Using too much foil can damage your oven, so be careful.
- **Ceramic, porcelain, and stoneware** — Use these if they are labeled “Microwave Safe.” If they are not labeled, test them to make sure they can be used safely. Never use dishes with metallic trim.
- **Plastic** — Use only if labeled “Microwave Safe.” Other plastics can melt.
- **Straw, wicker, and wood** — Use only for short-term heating, as they can be flammable.

Not Recommended

- **Glass jars and bottles** — Regular glass is too thin to be used in a microwave, and can shatter.
- **Paper bags** — These are a fire hazard, except for popcorn bags that are designed for microwave use.
- **Styrofoam plates and cups** — These can melt and leave an unhealthy residue on food.
- **Plastic storage and food containers** — Containers such as margarine tubs can melt in the microwave.
- **Metal utensils** — These can damage your oven. Remove all metal before cooking.

Testing Utensils

If you are not sure whether a dish is microwave-safe or not, you can perform this test:

1. Fill a 1 cup glass measuring cup with water and put it inside your oven, next to the dish you want to test.

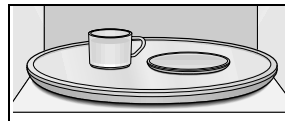

2. Press the **Start** (◊) **+30 s** button 4 times to heat for two minutes.

The water should be warm and the dish you are testing should be cool. If the dish is warm, then it is absorbing microwave energy and is not acceptable for use in the microwave.

Cooking Techniques

Stirring

Stir foods such as casseroles and vegetables while cooking to distribute heat evenly. Food at the outside of the dish absorbs more energy and heats more quickly, so stir from the outside to the center. The oven will turn off when you open the door to stir your food.

Arrangement

Arrange unevenly shaped foods, such as chicken pieces or chops, with the thicker, meatier parts toward the outside of the turntable where they receive more microwave energy. To prevent overcooking, place thin or delicate parts toward the center of the turntable.

Shielding

Shield food with narrow strips of aluminum foil to prevent overcooking. Areas that need shielding include poultry wing-tips, the ends of poultry legs, and corners of square baking dishes. Use only small amounts of aluminum foil. Larger amounts can damage your oven.

Turning

Turn foods over midway through cooking to expose all parts to microwave energy.

Standing

Foods cooked in the microwave build up internal heat and continue to cook for a few minutes after the oven stops. Let foods stand to complete cooking, especially foods such as roasts and whole vegetables. Roasts need this time to complete cooking in the center without overcooking the outer areas. All liquids, such as soup or hot chocolate, should be shaken or stirred when cooking is complete. Let liquids stand a moment before serving. When heating baby food, stir well and test the temperature before serving.

Cooking Instruction

Adding Moisture

Microwave energy is attracted to water molecules. Food that is uneven in moisture content should be covered or allowed to stand so that the heat disperses evenly. Add a small amount of water to dry food to help it cook.

General Tips



- Dense foods, such as potatoes, take longer to heat than lighter foods. Foods with a delicate texture should be heated at a low power level to avoid becoming tough.
- Altitude and the type of cookware you are using can affect cooking time. When using a new recipe, use the minimum cooking time and check the food occasionally to prevent overcooking.
- Foods with a non-porous skin or shell, such as potatoes, eggs, or hot dogs, should be pierced to prevent bursting.
- Frying with heating oil or fat is not recommended. Fat and oil can suddenly boil over and cause severe burns.
- Some ingredients heat faster than others. For example, the jelly inside a jelly doughnut will be hotter than the dough. Keep this in mind to avoid burns.
- Home canning in the microwave oven is not recommended because all harmful bacteria may not be destroyed by the microwave heating process.
- Although microwaves do not heat the cookware, the heat is often transferred to the cookware. Always use pot holders when removing food from the microwave and instruct children to do the same.

Appendix

Troubleshooting Guide

Before you call a repair person for your oven, check this list of possible problems and solutions.

The oven does not work properly.

- Check the battery voltage. The operating voltage for the oven should be greater than 21.5V or less than 29.5V.
- Make sure that the door is closed securely.
- Make sure that the heating time was properly set.
- Make sure that the **Start**() **+30 s** button is pressed. If door is open, close the door and press the **Start**() **+30 s** button again.
- Check if the safety fuse is installed to the positive cable(near battery).
- Check if the connection cable terminals are properly connected to the oven.
- Improper use of the microwave stops oven operation. The Display shows Error Codes (page 9)

Food heats too slowly.

- Check if the container is microwavable.
- Do not put too much food in the oven at one time.
- Check if the heating time was too short.
- Check if the battery voltage is too low.

You see sparks or arcing.

- Remove any metallic utensils, cookware, or metal ties. If using foil, use only narrow strips and allow at least one inch between the foil and interior oven walls.

The turntable makes noises or sticks.

- Clean the turntable, roller ring and oven floor.
- Make sure the turntable and roller ring are positioned correctly.

Appendix(continued)

GB

Care and Cleaning

Follow these instructions to clean and care for your oven.

- Keep the inside of the oven clean. Food particles and spilled liquids can stick to the oven walls, causing the oven to work less efficiently.
- Wipe up spills immediately. Use a damp cloth and mild soap. Do not use harsh detergents or abrasives.
- To help loosen baked on food particles or liquids, heat two cups of water (add the juice of one lemon if you desire to keep the oven fresh) in a four-cup measuring glass at High power for five minutes or until boiling. Let stand in the oven for one or two minutes.
- Remove the glass tray from the oven when cleaning the oven or tray. To prevent the tray from breaking, handle it carefully and do not put it in water immediately after cooking. Wash the tray carefully in warm sudsy water or in the dishwasher.
- Clean the outside surface of the oven with soap and a damp cloth. Dry with a soft cloth. To prevent damage to the operating parts of the oven, don't let water seep into the openings.
- Wash the door window with very mild soap and water. Be sure to use a soft cloth to avoid scratching.
- If steam accumulates inside or outside the oven door, wipe with a soft cloth. Steam can accumulate when operating the oven in high humidity and in no way indicates microwave leakage.
- Never operate the oven without food in it; this can damage the magnetron tube or glass tray. You may wish to leave a cup of water in the oven when it is not in use to prevent damage if the oven is accidentally turned on.

Specifications

Model	DE6612
Oven cavity	17 liter
Operating Voltage	24V DC
Breaking Voltage	Min. 21.5V, Max 29.5V
Input Current	31A
Power Consumption	750W
Operating frequency	2,450 MHz
Output Power	500W (IEC-705)
Main Fuse	32V DC, 80A
Dimensions(WxHxD)	
Outside(mm)	460(W) X 247(H) X 347(D)
Oven(mm)	290(W) X 179(H) X 312(D)
Net/Gross Weight	8.1/10.1kg approx.

