

# Panasonic®

## Operating Instruction and Cook Book Microwave Oven Household Use Only

**INVERTER**



Model Number: **NN-ST680S**  
**NN-ST780S**

Please read these instructions carefully before using this product, and save this manual for future use.

We are glad you have chosen to purchase a PANASONIC microwave oven. Before operating this oven, please read these instructions carefully and completely, and keep them for further reference.

If you have only used a microwave oven for reheating and defrosting, with Panasonic's Inverter Technology you can be reassured of excellent results when cooking a variety of foods, as the 'soft' penetration of microwave energy to the centre of food helps prevent over cooking on edges and surfaces. Foods can now be gently simmered without the concern of boil over.

After reading the introductory chapter, we are sure you will be able to master the basic techniques and thereby develop a firm understanding of your new oven. This book includes recipes from starters to desserts. After trying our recipes be sure to adapt your favourite recipes to microwave methods.

Start experimenting now, and enjoy the first class results you will achieve by using your new microwave oven.

Panasonic Australia Pty. Ltd.  
Locked Bag 505  
Frenchs Forest NSW 1640



PANASONIC NZ LTD  
CUSTOMER CARE CENTRE  
350 Te Irirangi Drive  
East Tamaki, Auckland  
Private Bag 14911  
Panmure, Auckland

Phone: (09) 272-0178  
Fax: (09) 272-0134

PANASONIC CONSUMER  
COMPANY  
Unit 10, Growthpoint Business  
Park, Tonnetti Street, Halfway  
House, Midrand 1686  
P.O Box 1711, Halfway  
House, 1685, South Africa

Customer Support Centre: 086 11 77 777  
Fax: (011) 313-1706

The serial number of this product may be found on the left side of the control panel. You should note the model number and serial number of this oven in the space provided and retain this book as a permanent record of your purchase for future reference.

MODEL NUMBER \_\_\_\_\_

SERIAL NUMBER \_\_\_\_\_

DATE OF PURCHASE \_\_\_\_\_

# Table of Contents

## Before Operation

Safety Instructions.....	1
Installation and General Instructions.....	2
Microwaves and How They Work.....	3
Cookware and Utensils Guide .....	3-4
Feature Diagram .....	5
Control Panel .....	6
Ingredient Conversion Chart .....	13

## Operation and Hints

Let's Start to Use Your Oven .....	7
Operation Guide in the Display Window .....	7
To Set Clock.....	8
To Use Child Safety Lock.....	8
To Use Timer Pad.....	14
To Cook by Micro Power and Time .....	9
using Sensor Cook Pads .....	12
To Reheat by Micro Power and Time .....	9
using Sensor Reheat Pad .....	13
To Defrost by Micro Power and Time .....	9-11
using Inverter Turbo Defrost Pad .....	10
Quick Guide to Operation.....	18

## Maintenance

Before Requesting Service .....	15
Care of Your Oven .....	16
Technical Specifications.....	16
Panasonic Warranty.....	17

## Cookbook

Microwave Recipe Preparation and Techniques .....	19-21
Reheat .....	22-24
Soups and Snacks.....	25-26
Fish and Shellfish.....	27-28
Poultry and Eggs.....	29-32
Meat.....	33-36
Vegetables and Legumes .....	37-42
Rice, Pasta and Noodles .....	43-48
Cakes, Desserts and Slices .....	49-52
Sauces and Extras .....	53-54

# Safety Instructions

## READ CAREFULLY AND KEEP FOR FUTURE REFERENCE

### Precautions to be taken when using Microwave Ovens for Heating foodstuffs

**INSPECTION FOR DAMAGE.** A microwave oven should only be used if an inspection confirms all of the following conditions:

1. The door fits squarely and securely and opens and closes smoothly.
2. The door hinges are in good condition.
3. The metal plates of a metal seal on the door are neither buckled nor deformed.
4. The door seals are neither covered with food nor have large burn marks.

**PRECAUTIONS.** Microwave radiation from microwave ovens can cause harmful effects if the following precautions are not taken:

1. Never tamper with or deactivate the interlocking devices on the door.
2. Never poke an object, particularly a metal object, through a grille or between the door and the oven while the oven is operating.
3. Never place saucepans, unopened cans or other heavy metal objects in the oven.
4. Do not let other metallic articles, e.g., fast food foil containers, touch the side of the oven.
5. Clean the oven cavity, the door and the seals with water and a mild detergent at regular intervals. Never use any form of abrasive cleaner that may scratch or scour surfaces around the door.
6. Always use the oven with trays or cookware recommended by the manufacturer.
7. Never operate the oven without a load (i.e., an absorbing material such as food or water) in the oven cavity unless specifically allowed in the manufacturer's literature.
8. For horizontally hinged doors, never rest heavy objects such as food containers on the door while it is open.
9. Do not place sealed containers in microwave ovens. Baby bottles fitted with a screw cap or a teat are considered to be sealed containers.
10. This appliance is not intended for use by persons (including children) with reduced physical, sensory or mental capabilities, or lack of experience and knowledge, unless they have been given supervision or instruction concerning use of the appliance by a person responsible for their safety.
11. Young children should be supervised to ensure that they do not play with the appliance.

### Important Instructions

**WARNING**—To reduce the risk of burns, electric shock, fire, injury to persons or excessive microwave energy:

1. Read all instructions before using the microwave oven.
2. Some products such as whole eggs and sealed containers - (for example, closed glass jars **and sealed baby bottles with teat**) - may explode and should not be heated in the microwave oven.
3. Use this microwave oven only for its intended use as described in this manual.
4. As with any appliance, close supervision is necessary when used by children.
5. Do not operate this microwave oven if it is not working properly or if it has been damaged or dropped.
6. To reduce the risk of fire in the oven cavity:
  - (a) Do not overcook food. Carefully attend microwave oven if paper, plastic, or other

combustible materials are placed inside the oven to facilitate cooking.

- (b) Heating therapeutic wheat bags is not recommended. If heating, do not leave unattended and follow manufacturers' instructions carefully.
  - (c) Remove wire twist-ties from bags before placing bag in oven.
  - (d) If materials inside the oven should ignite, keep oven door closed, turn oven off at the wall switch, or shut off power at the fuse or circuit breaker panel.
  - (e) Never leave microwave unattended while cooking or reheating.
7. Failure to maintain the oven in a clean condition could lead to deterioration of the surface that could adversely affect the life of the appliance and possibly result in a hazardous situation.

### Earthing Instructions

This microwave oven must be earthed. In the event of an electrical short circuit, earthing reduces the risk of electric shock by providing an escape wire for the electric current. This microwave oven is equipped with a cord having an earthing wire with an earthing plug. The plug must be plugged into an outlet that is properly installed and earthed.

**WARNING**—Improper use of the earthing plug can result in a risk of electric shock.

**WE CERTIFY THAT THIS MICROWAVE OVEN HAS BEEN INSPECTED AND COMPLIES WITH THE REQUIREMENTS OF REGULATION 3, SUBCLAUSE(2), OF THE MICROWAVE OVENS REGULATIONS 1982.**

(This statement applicable only to New Zealand.)

**We certify that this microwave oven has been inspected and complies with the safety requirements of government notice 466 of March 1981, and complies with the Radio Regulation of government notice 587 of March 1986.**

(This statement applicable only to South Africa)

### WARNING

- a) The door seals and door seal areas should be cleaned with a damp cloth. The appliance should be inspected for damage to the door seals and door seal areas and if these areas are damaged the appliance should not be operated until it has been repaired by a qualified service technician trained by the manufacturer.
- b) It is hazardous for anyone other than a competent person to carry out any service or repair operation that involves the removal of a cover which gives protection against exposure to microwave energy.
- c) If the supply cord of this appliance is damaged, it must be replaced by a qualified service technician with the special cord available only from the manufacturer.
- d) Before use, the user should check that whether the utensils are suitable for use in microwave ovens.
- e) Liquids or other foods must not be heated in sealed containers since they are liable to explode.
- f) Only allow children to use the oven without supervision when adequate instructions have been given so that the child is able to use the oven in a safe way and understands the hazards of improper use.

# Installation and General Instructions

## General Use

1. In order to maintain high quality, do not operate the oven when empty. The microwave energy will reflect continuously throughout the oven if no food or water is present to absorb energy. This can lead to damage to the microwave oven including arcing within the oven cavity.
2. If smoke is observed, press the **STOP/RESET** Pad and leave door closed in order to stifle any flames. Disconnect the power cord, and/or shut off power at the fuse or circuit breaker panel.
3. Do not dry clothes, newspapers or other materials in oven. They may catch on fire.
4. Do not use recycled paper products, unless the paper product is labelled as safe for microwave oven use. Recycled paper products may contain impurities which may cause sparks and/or fires when used.
5. Do not use newspapers or paper bags for cooking.
6. Do not hit or strike the Control Panel. Damage to controls may occur.
7. **POT HOLDERS** may be needed as heat from food is transferred to the cooking container and from the container to the Glass Tray. The GlassTray can be very hot after removing the cooking container from the oven.
8. Do not store flammable materials next to, on top of, or in the oven. It could be a fire hazard.
9. Do not cook food directly on Glass Tray unless indicated in recipes. (Food should be placed in a suitable cooking utensil.)
10. **DO NOT** use this oven to heat chemicals or other non-food products. **DO NOT** clean this oven with any product that is labelled as containing corrosive chemicals. **The heating of corrosive chemicals in this oven may cause microwave radiation leaks.**
11. Do not leave the microwave unattended while reheating or cooking food in disposable containers made of plastic, paper or other combustible materials, as these types of containers can ignite if overheated.

## Placement of Oven

1. The oven must be placed on a flat, stable surface. For correct operation, the oven must have sufficient air flow. **Allow 15 cm of space on the top of the oven, 10 cm at the back, and 5 cm on both sides. If one side of the oven is placed flush to wall, the left side or top must not be blocked. Do not remove feet.**
  - a. Do not block air vents. If they are blocked during operation, the oven may be overheated and damaged. When using any cloth over the oven, the air intake and exhaust should not be blocked. Also allow sufficient space on back and both sides of the oven.
  - b. Do not place oven near a hot or damp surface such as a gas stove, electric range or sink etc.
  - c. Do not operate oven when room humidity is too high.
2. This oven was manufactured for household use only.
3. The appliance is freestanding type and shall not be placed in a cabinet.

## Circuits

Your microwave oven should be operated on a separate 10 A circuit from other appliances. Failure to do this may cause the power board fuse to blow, and/or food to cook slower. Do not insert higher value fuse in the power board.

## Food

1. Do not use your oven for home canning or the heating of any closed jar. Pressure will build up and the jar may explode. In addition, the microwave oven cannot maintain the food at the correct canning temperature. Improperly canned food may spoil and be dangerous to consume.
2. Do not attempt to deep fat fry in your microwave oven.
3. Do not boil eggs in their shell and whole hard-boiled eggs (unless otherwise stated in Cooking Guide section). Pressure will build up and the eggs will explode.
4. Potatoes, apples, egg yolks, chicken wings, whole squash and sausages are examples of foods with nonporous skins. This type of food must be pierced before cooking, to prevent bursting.
5. When heating liquids, e.g. soup, sauces and beverages, in your microwave oven, overheating the liquid beyond boiling point can occur without evidence of bubbling. This could result in a sudden boil over of hot liquid. To prevent this possibility the following steps should be taken:
  - a) Avoid using straight-sided containers with narrow necks.
  - b) Do not overheat.
  - c) Stir the liquid before placing the container in the oven and halfway through cooking time.
  - d) After heating, allow to stand in the oven for a short time, stirring again before carefully removing the container.
6. **DO NOT USE A CONVENTIONAL MEAT THERMOMETER IN THE MICROWAVE OVEN. To check the degree of cooking of roasts and poultry use a MICROWAVE THERMOMETER.** Alternatively, a conventional meat thermometer may be used after the food is removed from the oven. If undercooked, return meat or poultry to the oven and cook for a few more minutes at the recommended power level. It is important to ensure that meat and poultry are thoroughly cooked.
7. **COOKING TIMES given in the Cooking Guide section are APPROXIMATE.** Factors that may affect cooking time are preferred degree of moisture content, starting temperature, altitude, volume, size, shape of food and utensils used. As you become familiar with the oven, you will be able to adjust for these factors.
8. **It is better to UNDERCOOK RATHER THAN OVERCOOK foods.** If food is undercooked, it can always be returned to the oven for further cooking. If food is overcooked, nothing can be done. Always start with minimum cooking times recommended.
9. Extreme care should be taken when cooking popcorn in a microwave oven. Cook for minimum time as recommended by manufacturer. Use the directions suitable for the wattage of your microwave oven. **NEVER** leave oven unattended when popping popcorn.
10. When heating food in plastic or paper containers, check the oven frequently due to the possibility of ignition.
11. The contents of feeding bottles and baby food jars are to be stirred or shaken and the temperature is to be checked before consumption, in order to avoid burns.



# Microwaves and How They Work

Microwaves are a form of high frequency radio waves similar to those used by a radio, including AM, FM and CB. They are similar to a television where the radio waves are converted to a picture on the screen. However, microwaves are much shorter than radio waves; approximately twelve centimetres wave length. Electricity is converted into microwave energy by the magnetron tube (which is the heart of the microwave oven).

From the magnetron tube, microwave energy is transmitted to the oven cavity through a small plastic covered piece. The microwaves are converted to heat in the food. The microwaves enter from the outside of the food and travel through the food losing half of their power every two to three centimetres. Continued cooking to the centre occurs by conduction.

Although pacemakers used to be affected by microwaves (as well as by other radio waves), they are now shielded and are not bothered by these interferences. This allows people with pacemakers to sit calmly by their radio or television and cook with microwave ovens.

When microwaves come in contact with a substance, any one or combination of three things may occur.

They can be:

1. REFLECTED
2. TRANSMITTED
3. ABSORBED

## Reflection:

Metal substances REFLECT microwave energy and because there is no absorption, there is no heating. This is why the oven interior is either stainless steel or epoxy-coated steel. This ensures that the microwaves are kept inside the cavity and evenly distributed throughout the food with the help of the turntable.

## Transmission:

Such substances as paper, glass and plastic TRANSMIT microwave energy and do not become hot except from food. Because these substances do not reflect or absorb microwave energy, they are ideal materials for microwave cooking containers.

## Absorption:

Food contains moisture and will ABSORB microwave energy, which causes the moisture molecules within the food to vibrate at an incredible rate (2,450,000,000 times per second). Friction, created by the vibration, produces heat energy which is conducted throughout the food.

# Cookware and Utensils Guide

It is important to use the correct container when cooking in a microwave oven. The following will help you make the right selection.

## How to Test a Container for Safe Microwave Oven Use

**TO TEST A CONTAINER FOR SAFE MICROWAVE OVEN USE:** Fill a 1-cup glass measure with cool water and place it in the microwave oven alongside the empty container to be tested; **heat one (1) minute at P10**. If the container is microwave oven-safe (transparent to microwave energy), the container should remain comfortably cool, the water in glass measure should be hot. If the container is hot, it has absorbed some microwave energy and should NOT be used. This test cannot be used for plastic containers.

## Paper Products and Freezer Wrap

Waxed paper, paper plates, cups and napkins should not be used for heating or cooking food. Freezer wrap should not be used as it is not heat resistant and may melt. Paper towel, greaseproof paper and bake paper may be safely used for short periods of time for covering or lining.

## Glass, Ceramic and China

**Heat-Resistant glass cookware** is invaluable in microwave cooking. Many of these items are readily available in most homes: glass jugs, mixing bowls, loaf dishes, covered casseroles, oblong baking dishes, pie plates and round or square cake dishes. Examples of this type of cookware are Pyrex® and Corningware®.

**Dinnerware** can be used for microwave heating. Many brands of dinnerware are microwave safe. Check the care information for reference to microwave use for dinnerware and serving pieces. If dinnerware is marked ovenproof, it frequently is safe to use in the microwave oven. However, to be sure, check by conducting microwave dish test previously mentioned.

**Several types of glassware and dinnerware** are not recommended for use in the microwave oven. Do not use dishes with metallic trim or containers with metal parts. Do not use cups or mugs with glued on handles, as they may fall off with continued heating. Do not use delicate glassware. Although the glassware may be transparent to microwave energy the heat from the food may cause the glassware to crack.

# Cookware and Utensils Guide *(continued)*

## Plastics

**Plastic dishes, cups and some freezer containers** should be used with care in a microwave oven.

Choose plastic containers carefully, as some plastic containers may become soft, melt and may scorch. The majority of plastic dishes, even those designed for use in the microwave oven, are not suitable for cooking foods with high fat or sugar content, or for lengthy cooking times. Most microwave plastic dishes should not be used for longer than 3 to 5 minutes on **P10** power. These dishes, although not suitable for extended cooking, may be used successfully for defrosting or for use on lower power levels.

**Cooking Bags** designed to withstand boiling, freezing, or conventional heating are microwave safe. Prepare bags according to manufacturer's directions. When cooking by microwave, **DO NOT** use wire twist-ties to close bag. They can act as an antenna and cause arcing (sparks).

**DO NOT COOK IN PLASTIC FOOD STORAGE BAGS.**

**Plastic Wrap** such as GLAD WRAP® can be used to cover dishes in most recipes. Over an extended heating time, some disfiguration of the wrap may occur. When removing plastic wrap "covers", as well as any glass lid, be careful to remove it away from you to avoid steam burns.

Loosen plastic but let dish stand, covered.

## Jars and Bottles

Jars and bottles can be used to warm food to serving temperature, if the lid is removed first. Cooking should not be done in these containers since most are not heat resistant and during extended heating times, heat from food would cause cracking or breaking.

## Metal

Metal cookware or utensils, or those with metallic trim, should **NOT** be used in the microwave. Since microwave energy is reflected by metal, foods in metal containers will not cook evenly. There is also a possibility of "arcing."

Although metal utensils should be avoided in microwave cooking, some metal can be helpful when used correctly.

Aluminum foil can be used safely, if certain guidelines are followed, to prevent overcooking. Small pieces of foil are used to shield areas such as chicken wings, tips of roasts, or other thin parts that cook before the rest of the recipe is finished. Make sure foil is attached securely and doesn't touch sides of oven, otherwise arcing may occur. Foil lined containers, either cardboard or plastic, should **NOT** be used in the microwave oven as arcing could occur.

Metal twist-ties, either paper or plastic coated, should **NOT** be used in the microwave oven. Frozen dinner trays can be used in the microwave, if the container is no deeper than 2 cm and is filled with food. Metal skewers can not be used in microwave ovens as arcing may occur. Wooden skewers are readily available and give the same result.

**Shells:** Scalloped baking shells are best used during reheating and for short periods of cooking time only.

**Thermometers** are available for use in microwave ovens. **DO NOT USE CONVENTIONAL MERCURY TYPE CANDY OR MEAT THERMOMETERS** in food while cooking in the microwave oven.

## Straw, Wicker and Wood

Straw and wicker baskets may be used in the microwave oven for short periods of time to warm rolls or bread. Large wooden utensils, such as bowls or cutting boards should **NOT** be used for prolonged heating as the microwave energy may cause the wood to become dry and brittle.

# Feature Diagram

## Glass Tray

1. Do not operate the oven without the Roller Ring and Glass Tray in place.
2. Only use the Glass Tray specifically designed for this oven. Do not substitute another Glass Tray.
3. If Glass Tray is hot, allow to cool before cleaning or placing in water.
4. **Do not** cook directly on Glass Tray. Always place food on a microwave-safe dish, or on a rack set in a microwave-safe dish.
5. If food or utensil on Glass Tray touches oven walls, causing the tray to stop moving, the tray will automatically rotate in opposite direction. This is normal.
6. Glass Tray can rotate in either direction.

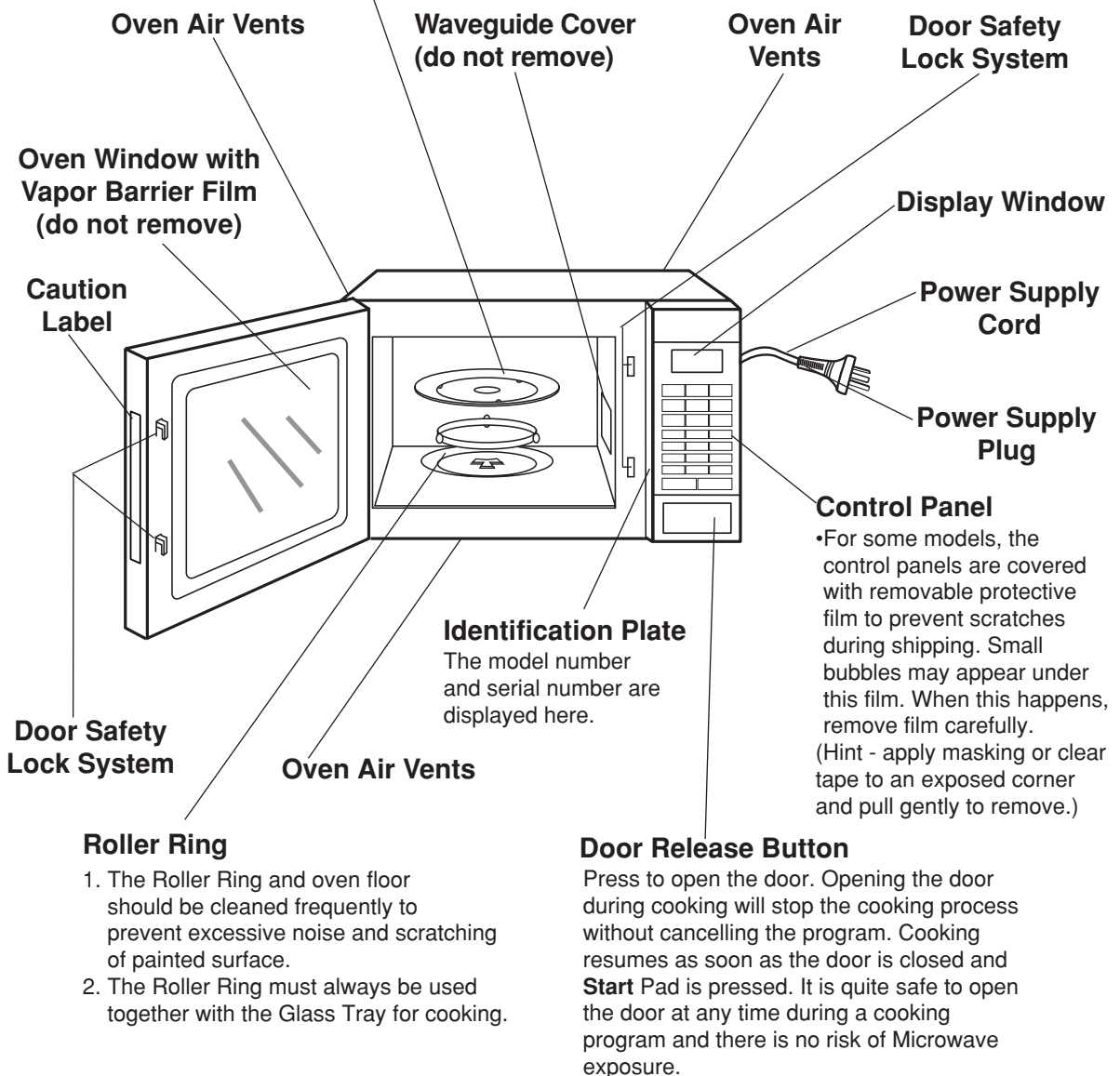

## Oven Light

Oven Light will turn on during cooking and also when door is opened.

## NOTE:

The above illustration is for reference only.



# Control Panel

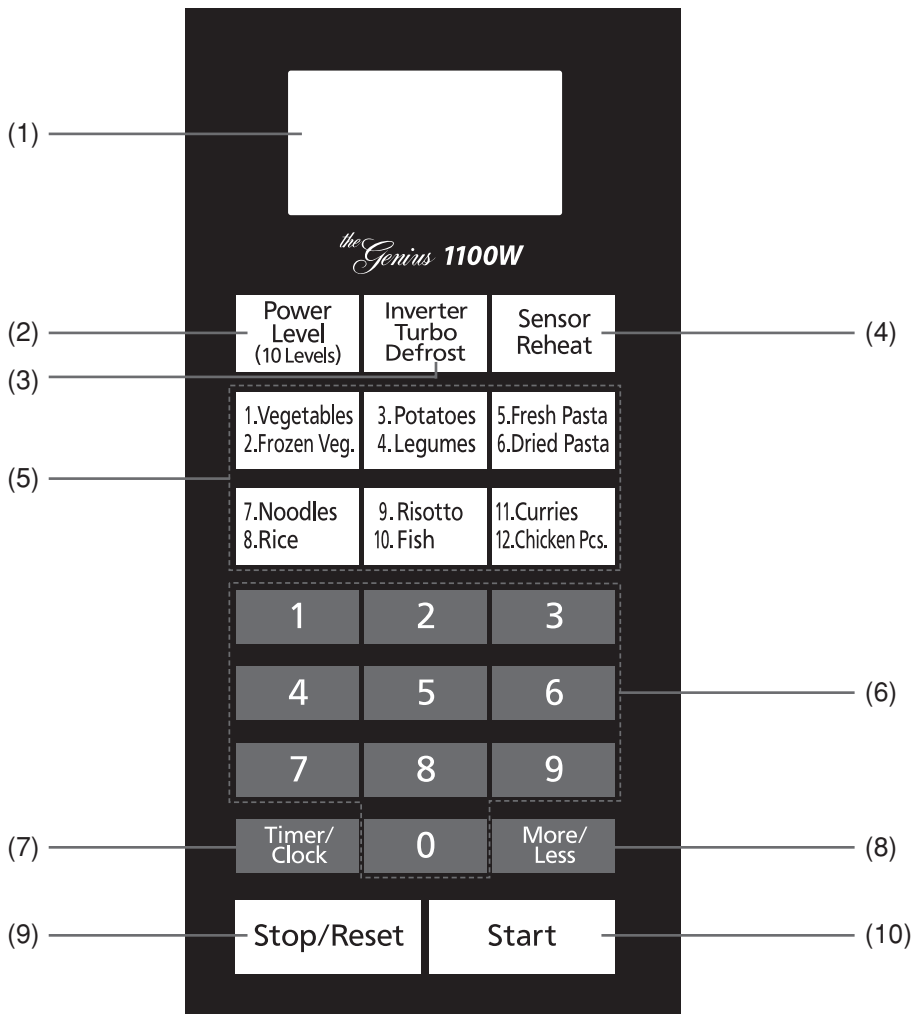

## CONTROL PANEL

- (1) **Display Window**
- (2) **Power Level Pad (pg. 9)**
- (3) **Inverter Turbo Defrost Pad (pg. 10)**
- (4) **Sensor Reheat Pad (pg. 13)**
- (5) **Sensor Cook Pads (pg. 12)**
- (6) **Number Pads**
- (7) **Timer/Clock Pad (pg. 8, 14)**
- (8) **More/Less Pad (pg. 12)**

### (9) **Stop/Reset Pad**

**Before cooking:** One tap clears all your instructions.

**During cooking:** One tap temporarily stops the cooking process. Another tap cancels all your instructions and colon or time of day appears in the Display Window.

### (10) **Start Pad**

One tap allows oven to begin functioning. If door is opened or **Stop/Reset Pad** is pressed once during oven operation, **Start Pad** must again be pressed to restart oven.

## Word Prompters

When pads are pressed, a beep sound is heard and the corresponding letter or word(s) appear and roll across the Display Window. If a pad is pressed and no beep is heard, the unit does not or cannot accept the instruction. As each pad is pressed the corresponding word(s) roll across the Display Window. Words will automatically appear to prompt the user to perform the next step. It is not necessary to wait for the words to appear before pressing pads for the next step. A two beep sound is heard between stages. At the end of any complete programme, the oven will beep five times and "ENJOY YOUR MEAL" will appear in the Display Window.

### NOTE:

If an operation is set and **Start Pad** is not pressed, after 6 minutes, the oven will automatically cancel the operation. The display will revert back to clock or colon mode.

# Let's Start To Use Your Oven!

## 1 Plug in

Plug into a properly earthed electrical outlet. "WELCOME TO PANASONIC MICROWAVE OVEN COOKING" appears in the Display Window. (This will immediately cease when any pad is pressed.)

## 2 Open Door

Open the door and place container with food on Glass Tray in the oven. Then close the door.

## 3 Select Power Level

e.g. P7

Press **Power Level Pad** four times.  
(see page 9 for Micro Power chart)

Power  
Level  
(10 Levels)

## 4 Set Time

e.g. 1 minute 30 seconds

**Press number Pads**

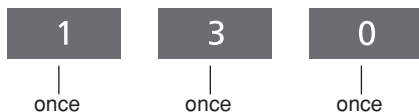

## 5 Press

Start

# Operation Guide in the Display Window

To assist you in programming your oven, the following operation will appear in the Display Window. When you become familiar with your oven, the Operation Guide can be turned off.

**To turn off:**



**To turn on:**



# To Set Clock

You can use the oven without setting the clock.

## 1 Press **Timer/Clock** twice

Colon will blink in Display Window.

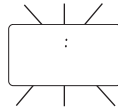

## 2 Enter Time of Day

Enter time of day using Number Pads e.g. 12:35

Clock is a 12 hour display. There isn't a.m. or p.m. setting.

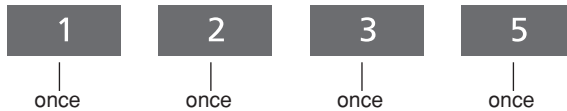

## 3 Press **Timer/Clock**

Colon stops blinking; time of day is entered and locked into Display Window.

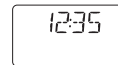

**NOTES:** 1. Oven will not operate while colon is still blinking

2. To reset time of day, repeat step 1 through 3.

3. The clock will keep the time of day as long as oven is plugged in and electricity is supplied.

4. Maximum time available is 12:59. Clock is 12 hour only. One o'clock will be displayed as 1:00 not 13:00.

# To Use Child Safety Lock

This feature allows you to prevent operation of the oven by a young child; however, the door will open. You can set Child Safety Lock when colon or time of day is displayed.

**To set:**



**To cancel:**



**NOTE:** To set or cancel child safety lock, **Start** pad or **Stop/Reset** pad must be pressed 3 times within 10 seconds.

# To Cook / Reheat / Defrost by **Micro Power and Time**

## 1 Select Power Level

Press **Power Level** Pad until the desired power level appears in the Display Window. (see chart below)

Power Level  
(10 Levels)

**NOTE:** When selecting P10 on the first stage, you can start from step 2.

## 2 Set Cooking Time

(P10: up to 30 minutes, other powers: up to 99 minutes and 99 seconds for a single stage)

e.g. 5 minutes

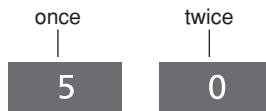

## 3 Press

Start

Cooking will start.  
The time in the Display Window will count down.

### For more than one stage cooking,

Repeat steps 1 & 2 above then press **Start**. The maximum number of stages for cooking is 3. The oven will beep twice between stages.

e.g. :

Stage 1	Stage 2	Stage 3
P10 for 10 minutes	P6 for 50 minutes	P4 for 20 minutes

### Micro Power:

The **Power Level** Pad gives you a selection of different power levels representing decreasing amounts of microwave energy, used for cooking foods at different speeds.

e.g. The lower the micro power setting, the more evenly the food cooks, although it will take a little longer. To select the correct power level for cooking different foods, refer to the chart below.

Press	POWER LEVEL	WATTAGE	EXAMPLE OF USE
1x	P10	1100 W	Boil water. Reheat. Cook vegetables, rice, pasta and noodles.
2x	P9	1000 W	Cook fresh fruits.
3x	P8	900 W	Cook cakes, desserts. Heat milk.
4x	P7	800 W	Cook pork, whole chicken and chicken pieces, dried peas and beans.
5x	P6	700 W	Cook beef, lamb and eggs. Melt butter.
6x	P5	600 W	Cook meatloaves. Melt chocolate.
7x	P4	400 W	Cook fish and seafood.
8x	P3	300 W	Thaw foods. Cook christmas pudding, corned beef.
9x	P2	200 W	Simmer soups, stews and casseroles (less tender cuts).
10x	P1	100 W	Keep cooked foods warm, simmer slowly.

### NOTE:

After using the oven over 3 minutes, the fan may rotate to cool the electric components and "COOL" appears in the display window. This is perfectly normal, and you can take out the food from the oven while the fan operates.

# To Defrost

## Turbo Defrost

This feature allows you to defrost meat, poultry and seafood automatically by just setting the weight of the food.

### 1 Set Weight

---

The shape and size of the food will determine the maximum weight the oven can accommodate. The recommended maximum weight of food depends on the oven cavity size. Weight must be programmed in kilograms and tenths of a kilogram (max 3.0 kg).

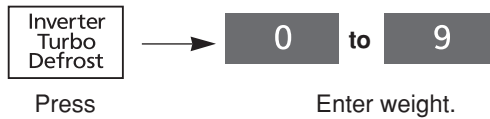

### 2 Press

---



Defrost time appears in the Display Window and begins to count down. When cooking time is longer than 60 minutes, the time will appear in hours and minutes.

**NOTE:**

For further information, refer to next page.

## Defrost by Micro Power and Time Setting

Defrosting is done on P3 Power

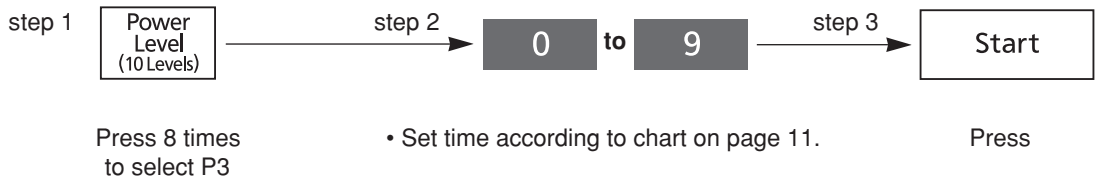



# Defrosting Tips and Techniques

## Preparation for Freezing:

1. Heavy-duty plastic wraps, bags and freezer wrap are suitable.
2. Freeze meats, poultry and fish in packages with only 1 or 2 layers of food. To aid in separating layers, place two pieces of wax paper between them.
3. REMOVE ALL AIR and seal securely.
4. LABEL package with type and cut of meat, date and weight.
5. Defrosting times given in the charts are for thoroughly frozen foods (i.e. at least 24 hours in freezer maintained at -18°C or lower).

## Defrosting Technique:

1. Remove from wrapper and set on a defrosting rack in a dish on Glass Tray.
2. On Turbo Defrost, the oven will beep during the defrosting time. At “beep”, turn over all meat, poultry, fish and shellfish. Break apart stewing meat, chicken pieces and minced meat. Separate chops and hamburger patties. Shield thin ends of roasts, poultry legs and wings, fat or bones with foil.
3. Throughout the defrosting time, remove any defrosted portions of mince or cubed meat, etc.
4. After defrosting, large roasts may still be icy in the centre. Let stand, 15 to 30 minutes, in refrigerator to complete defrosting.

## Defrosting Chart (by setting Micro Power at P3):

FOOD	APPROX. TIME (minutes per 500 g)	INSTRUCTION
<b>MEAT</b>		
Beef		
Minced Beef	7 - 9	Halfway through the defrost cycle, break apart minced beef, separate chops and remove meat that is defrosted.
Roast: Topside	8 - 10	
Beef Tenderloin	8 - 10	
Chuck or Rump	8 - 10	Turn meat over two to three times during defrosting.
Sirloin, rolled	8 - 10	
Steak	6 - 8	Shield edges and unevenly shaped ends of roasts halfway through the defrost cycle.
Miscellaneous	7 - 9	
<b>Pork/Lamb</b>		
Roast	8 - 10	Large roasts may still be icy in centre. Let stand.
Chops	6 - 8	
Ribs	6 - 8	
<b>POULTRY</b>		
<b>Chicken</b>		
whole	8 - 10	Turn poultry over two to four times during defrosting. Halfway through the defrost cycle, shield end of drumsticks, wings, breast bones and ends of poultry with foil.
pieces	7 - 9	
fillets	7 - 9	Break apart chicken pieces and remove small pieces such as wings, which may be defrosted before larger pieces.
<b>Duck</b>	7 - 9	
<b>Turkey</b>	8 - 10	Rinse poultry under cold water to remove ice crystals. Let stand 5 to 10 minutes, before cooking.
<b>FISH &amp; SHELLFISH</b>		
<b>Fish Fillets</b>	8 - 10	Halfway through the defrost cycle, turn whole fish or blocks of fillets over. Also, break apart prawns or scallops.
<b>Whole Fish</b>	7 - 9	
<b>Crabmeat</b>	6 - 8	Remove any pieces that are defrosted.
<b>Lobster Tails</b>	6 - 8	
<b>Sea Scallops</b>	6 - 8	
<b>Green Prawns</b>	6 - 8	Let stand, 5 to 10 minutes, before cooking.

# To Cook Using Sensor Cook

Sensor Cook allows you to cook foods without selecting times and power levels. The sensor detects the heat and humidity generated by the food and cooks your food automatically.

Place food into an appropriate sized dish for the volume of food you are cooking. Cover securely with plastic wrap or a securely fitting lid (do not use any snap closing lids). Plastic dishes are not suitable as a secure seal cannot be achieved and inaccurate cooking may result.

Food Category	Recommended Weight Range
<b>Sensor Reheat</b>	125 g - 1.0 kg
<b>Vegetables</b>	125 g - 500 g
<b>Frozen Veg.</b>	125 g - 1.0 kg
<b>Potatoes</b>	125 g - 1.0 kg
<b>Legumes</b>	1-4 cups
<b>Fresh Pasta</b>	125 g - 625 g
<b>Dried Pasta</b>	125 g - 500 g
<b>Noodles</b>	150 g - 800 g
<b>Rice</b>	1 cup - 2½ cups
<b>Risotto</b>	½ cup - 3 cups
<b>Fish</b>	125 g - 500 g
<b>Curries</b>	250 g - 750 g
<b>Chicken Pcs.</b>	400 g - 1000 g



- Select and press the appropriate pad for the food you are cooking. The category appears in the Display Window.  
eg. Press once for Vegetables  
twice for Froz. Veg.

If desired, press **More / Less** Pad.

- **Press**  
The food category you have selected remains in the display window. Do not stop the oven or open the door during this part of the cooking stage as inaccurate cooking may result. After the heat humidity is detected by the SENSOR, the remaining time appears in the Display Window and begins to count down.

- For information on individual categories refer to each chapter in the cookbook section.

## More/Less Pad:

More/  
Less

Each individual may prefer a variable cooked level to their food. After having using the Sensor Cook a few times, you may vary the level that your food is cooked to. By using the **More/Less** Pad, the Auto Sensor programmes can be adjusted to cook food for a longer or shorter time. Press

**More/Less** Pad before pressing **Start** Pad.

- 1 tap : More cooking with indication "MORE +"
- 2 taps: Less cooking with indication "Less -"
- 3 taps: Returns to average cooking result.

If you are satisfied with the result of the **SENSOR REHEAT/COOK** programme, you don't have to use this pad.

## For best results, follow these recommendations:

1. The door should not be opened before the time appears in the Display Window.
2. Do not use plastic dishes as a secure seal cannot be achieved and inaccurate cooking may occur.

# To Cook Using Sensor Reheat

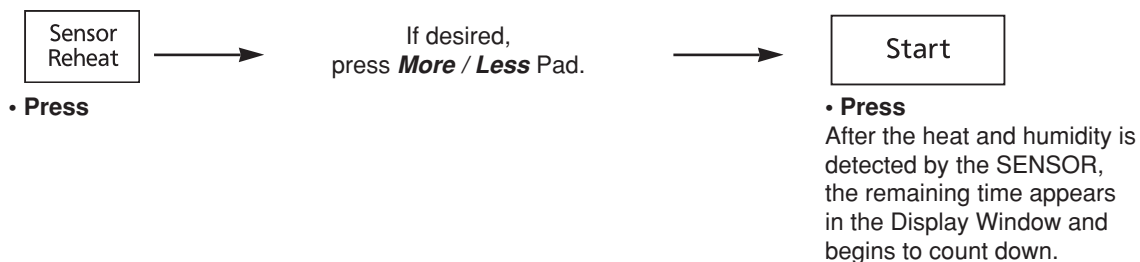

## For best results on Sensor Reheat, follow these recommendations:

1. Food being reheated should weigh between 125 g and 1.0 kg. For foods weighing less than 125 g and more than 1.0 kg, use a manual micro power setting.
2. All foods must be previously cooked and at room or refrigerator temperature (for sensor reheat) or frozen at -18°C for at least 24 hours (for frozen reheat).
3. Foods should always be covered loosely, but completely, with plastic wrap. (Do not use any snap closing lids.)
4. All foods should have a covered stand time of at least 3 to 5 minutes.
5. **Do not** reheat bread or pastry products (raw or uncooked), or beverages.
6. **Do not** use if oven cavity is warm (from previously cooked foods).

# INGREDIENT CONVERSION CHART

INGREDIENT CONVERSION CHART			
¼ cup	60 ml	¼ teaspoon	1 ml
⅓ cup	85 ml	½ teaspoon	2 ml
½ cup	125 ml	1 teaspoon	5 ml
⅔ cup	165 ml	2 teaspoons	10 ml
¾ cup	190 ml	3 teaspoons	15 ml
1 cup	250 ml	1 tablespoon	20 ml
1¼ cups	310 ml	1½ tbs	30 ml
1½ cups	375 ml	2 tbs	40 ml
2 cups	500 ml	3 tbs	60 ml
3 cups	750 ml	4 tablespoons	80 ml
3½ cups	875 ml		
4 cups	1 litre		
6 cups	1.5 litre		
8 cups	2 litre		

All recipes are tested using standard measurement that appear in the above chart.

# To Use Timer

## To Use as a Kitchen Timer

---

Press once.

Set desired amount of time.  
(up to 99 minutes and 99 seconds)

Press Start.  
Time will count down  
without oven operating.



## To Set Standing Time

---

Press once.

Set desired  
amount of standing time.  
(up to 99 minutes and 99 seconds)

Press Start.  
Cooking will start.  
After cooking, standing  
time will count down  
without oven operating.

Set the desired  
cooking program.  
(see Page 9)

Timer/  
Clock

0 to 9

Start



## To Set Delay Start

---

Press once.

Set desired  
amount of delay time.  
(up to 99 minutes and 99 seconds)

Press Start.  
Delayed time will count  
down. Then cooking  
will start.

Timer/  
Clock

0 to 9

Set the desired  
cooking program.  
(see Page 9)

Start

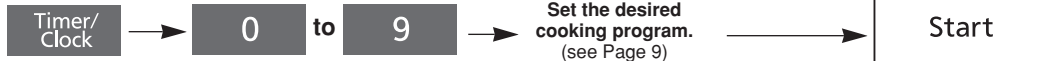

### NOTES:

1. If oven door is opened during the Standing Time, Delay Start or Kitchen Timer, the time in the Display Window will continue to count down.
2. Delay Start/Standing Time cannot be programmed before/after any Auto Control function. This is to prevent the standing temperature of the food from rising before defrosting or cooking begins. A change in the starting temperature could cause inaccurate results and / or food may deteriorate.

# Before Requesting Service

## THESE THINGS ARE NORMAL

The oven causes interference with my TV.

Some radio and TV interference might occur when you cook with the microwave oven. This interference is similar to the interference caused by small appliances such as mixers, vacuums, hair dryers, etc. It does not indicate a problem with your oven.

Steam accumulates on the oven door and warm air comes from the oven vents.

During cooking, steam and warm air are given off from the food. Most of the steam and warm air are removed from the oven by the air which circulates in the oven cavity. However, some steam will condense on cooler surfaces such as the oven door. This is normal.

I accidentally ran my microwave oven without any food in it.

Running the oven empty for a short time will not damage the oven. However, we do not recommend this.

### PROBLEM

### POSSIBLE CAUSE

### REMEDY

Oven will not turn on.	→	The oven is not plugged in securely.	Remove plug from outlet, wait 10 seconds and re-insert.
		Circuit breaker or fuse in your home is tripped or blown.	Contact the specified service centre.
		There is a problem with the outlet.	Plug another appliance into the outlet to check if the outlet is working.
Oven will not start cooking.	→	The door is not closed completely.	Close the oven door securely.
		<b>Start</b> was not pressed after programming.	Press <b>Start</b> Pad.
		Another programme has already been entered into the oven.	Press <b>Stop/Reset</b> Pad to cancel the previous programme and programme again.
		The programme has not been entered correctly.	Programme again according to the Operating Instructions.
	<b>Stop/Reset</b> has been pressed accidentally.	Programme over again.	
The word "LOCK" appears in the display window.	→	The Child Safety Lock was activated by pressing <b>Start</b> pad 3 times.	Deactivated Lock by pressing <b>Stop/Reset</b> pad 3 times.
The word "DEMO MODE"* appears on the screen.	→	The oven is in demonstration mode.	Deactivated mode by pressing <b>Micro power</b> Pad once, <b>Start</b> pad 4 times and <b>Stop/Reset</b> pad 4 times.
When the oven is turning on, there is noise coming from the Glass Tray.	→	The Roller Ring and oven bottom are dirty.	Clean these parts according to "Care of Your Microwave Oven" (see next page).
"H97" or "H98" appears in the display window.	→	The display indicates a problem with microwave generation system.	Contact the specified service centre.
"COOL" appears in the display window and the post fan operates after using the oven.	→	The fan rotates to cool the electric components. This is normal.	It is quite safe to take out the food from the oven while the fan operates.

\* DEMO MODE is designed for retail store display. Cooking and other functions will not operate during the DEMO mode. If it seems there is a problem with the oven, contact an authorised Service Centre.



# Care of Your Oven

**NOTE:** The oven should be cleaned regularly and any food deposits removed.

## BEFORE CLEANING:

Remove plug from outlet. If impossible, leave oven door open to prevent oven from accidentally turning on.

## AFTER CLEANING:

Be sure to replace the Roller Ring and Glass Tray in the proper position and press **Stop/Reset** Pad to clear the Display Window.

### Inside of the oven:

Wipe with a damp cloth. Mild detergent may be used if the oven gets very dirty. The use of harsh detergent or abrasives is not recommended.

### Glass Tray:

Remove and wash in warm soapy water or in a dishwasher. If grease accumulates, clean with a non-abrasive nylon mesh scouring pad and a non-abrasive cleanser.

### Outside oven surfaces and back vents.

To prevent overheating caused by blocked vents, clean periodically with damp cloth. To prevent damage to the operating parts inside the oven, water should not be allowed to seep into ventilation openings.

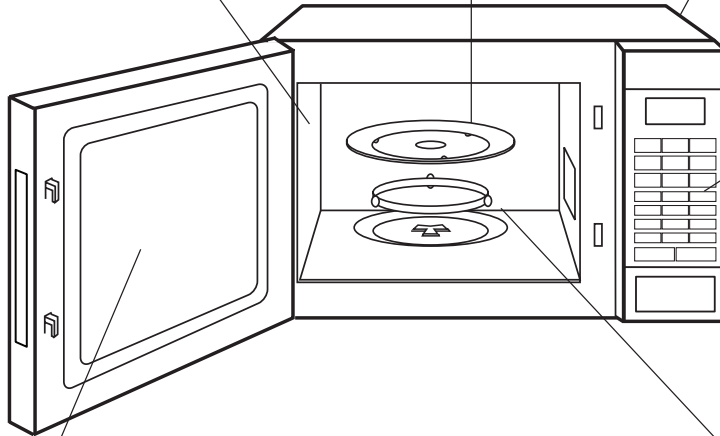

### Control Panel:

- If it becomes wet, clean with a soft, dry cloth. Do not use harsh detergents or abrasives on the Control Panel.

### Oven Door:

Wipe with a soft cloth when steam accumulates inside or around the outside of the oven door. This may occur when the microwave oven is operated under high humidity conditions and in no way indicates a malfunction of the unit or of microwave leakage.

### Roller Ring and oven cavity floor:

Wipe the bottom surface of the oven with mild detergent water or window cleaner and dry. Roller Ring may be washed in mild soapy water or dishwasher. These areas should be kept clean to avoid excessive noise and scratching of painted surface.

## Technical Specifications

	NN-ST680S	NN-ST780S
Power Supply:	230 - 240 V 50 Hz	
Power Consumption*:	1,050 W 4.6 A	1000 W 4.6 A
Power Requirement:	1,800 W 7.8 A	1800 W 8.0 A
Output*:	1,100 W	
Outside Dimensions (W x H x D):	518 mm x 301 mm x 406 mm	555 mm x 304 mm x 508 mm
Oven Cavity Dimensions (W x H x D):	375 mm x 225 mm x 386 mm	418 mm x 228 mm x 470 mm
Operating Frequency:	2,450 MHz	
Uncrated Weight:	Approx. 12 kg	Approx. 13.9 kg

\* IEC Test Procedure  
Specifications subject to change without notice.

# Panasonic Warranty

1. The product is warranted for 12 months from the date of purchase. Subject to the conditions of this warranty Panasonic or its Authorised Service Centre will perform necessary service on the product without charge for parts or labour if, in the opinion of Panasonic, the product is found to be faulty within the warranty period.
2. This warranty only applies to Panasonic products purchased in Australia and sold by Panasonic Australia or its Authorised Distributors or Dealers and only where the products are used and serviced within Australia or its territories. Warranty cover only applies to service carried out by a Panasonic Authorised Service Centre and only if valid proof of purchase is presented when warranty service is requested.
3. This warranty only applies if the product has been installed and used in accordance with the manufacturer's recommendations (as noted in the operating instructions) under normal use and reasonable care (in the opinion of Panasonic). The warranty covers normal domestic use only and does not cover damage, malfunction or failure resulting from use of incorrect voltages, incorrect installation, accident, misuse, neglect, build-up of dirt or dust, abuse, maladjustment of customer controls, mains supply problems, thunderstorm activity, infestation by insects or vermin, tampering or repair by unauthorised persons (including unauthorised alterations), exposure to abnormally corrosive conditions or any foreign object or matter having entered the product.
4. This warranty does not cover the following items unless the fault or defect existed at the time of purchase:

(a) Video or Audio Tapes	(d) Cabinet Parts	(g) Microwave Oven cook plates.
(b) Video or Audio Heads and Stylii resulting from wear and tear in normal use	(e) User replaceable Batteries	(h) Kneader mounting shaft unit (bread bakery)
(c) Shaver Heads or Cutters	(f) Thermal Paper, Toner/Ink Cartridges, Drums, Developer, Film (Ink/Ribbon), Film Cartridge, Printer Heads	
5. If warranty service is required you should:
  - Telephone Panasonic's Customer Care Centre on 132600 or visit our website and use the Service Centre Locator for the name/address of the nearest Authorised Service Centre.
  - Send or bring the product to a Panasonic Authorised Service Centre together with your proof of purchase receipt as a proof of purchase date. Please note that freight and insurance to and / or from your nearest Authorised Service Centre must be arranged by you.
  - Note that home or pick-up/delivery service is available for the following products in the major metropolitan areas of Australia or the normal operating areas of the nearest Authorised Service Centres:

(a) Picture tube (CRT) based Television Receivers (screen sizes greater than 66cm); Rear Projection TV's; Plasma/LCD televisions / displays (screen size greater than 103 cm)	(b) Convection/Combination Microwave Ovens	(c) Whiteboard (except portable type)
---	--	---------------------------------------
6. The warranties hereby conferred do not extend to, and exclude, any costs associated with the installation, deinstallation or re-installation of a product, including costs related to the mounting, de-mounting or remounting of any screen, (and any other ancillary activities), delivery, handling, freighting, transportation or insurance of the product or any part thereof or replacement of and do not extend to, and exclude, any damage or loss occurring by reason of, during, associated with, or related to such installation, de-installation, re-installation or transit.

Panasonic Authorised Service Centres are located in major metropolitan areas and most regional centres of Australia, however, coverage will vary dependant on product. For advice on exact Authorised Service Centre locations for your product, please telephone our Customer Care Centre on 132600 or visit our website and use the Service Centre Locator.

Unless otherwise specified to the consumer the benefits conferred by this express warranty are additional to all other conditions, warranties, guarantees, rights and remedies expressed or implied by the Trade Practices Act 1974 and similar consumer protection provisions contained in legislation of the States and Territories and all other obligations and liabilities on the part of the manufacturer or supplier and nothing contained herein shall restrict or modify such rights, remedies, obligations or liabilities.

November 2005

**THIS WARRANTY CARD AND THE PURCHASE DOCKET (OR SIMILAR PROOF OF PURCHASE)  
SHOULD BE RETAINED BY THE CUSTOMER AT ALL TIMES**

**If you require assistance regarding warranty conditions or any other enquiries,  
please visit the **Panasonic Australia** website**

**[www.panasonic.com.au](http://www.panasonic.com.au) or by phone on 132 600**







**If phoning in, please ensure you have your operating instructions available.**

**Panasonic Australia Pty. Limited**

ACN 001 592 187 ABN 83 001 592 187

Locked Bag 505, Frenchs Forest, NSW 2086  
[www.panasonic.com.au](http://www.panasonic.com.au)

# Quick Guide to Operation

Feature	How to Operate			
<b>To Set Clock</b> <small>(☞ page 8)</small>	 <p>Press twice                      Set time of day. (Max 12:59)                      Press</p>			
<b>To Set / Cancel Child Safety Lock</b> <small>(☞ page 8)</small>	<table border="0" style="width: 100%;"> <tr> <td style="width: 50%; vertical-align: top;"> <p><b>To Set:</b></p> <p>Start → LOCK</p> <p>Press 3 times</p> </td> <td style="width: 5%; text-align: center; vertical-align: middle;"> </td> <td style="width: 45%; vertical-align: top;"> <p><b>To Cancel:</b></p> <p>Stop/Reset → 12:35</p> <p>Press 3 times</p> </td> </tr> </table>	<p><b>To Set:</b></p> <p>Start → LOCK</p> <p>Press 3 times</p>		<p><b>To Cancel:</b></p> <p>Stop/Reset → 12:35</p> <p>Press 3 times</p>
<p><b>To Set:</b></p> <p>Start → LOCK</p> <p>Press 3 times</p>		<p><b>To Cancel:</b></p> <p>Stop/Reset → 12:35</p> <p>Press 3 times</p>		
<b>To Cook / Reheat / Defrost by Micro Power and Time Setting</b> <small>(☞ page 9)</small>	 <p>Select power.                      Set the cooking time.                      Press</p>			
<b>To use Turbo Defrost Pad</b> <small>(☞ page 10)</small>	 <p>Press                      Set weight.                      Press</p>			
<b>To Cook using "Sensor Cook" Pads (S)</b> <small>(☞ page 12)</small>	<p>Press until desired food category pad appears.            e.g.  → ( More/Less ) → Start</p> <p style="text-align: center;">optional                      Press</p>			
<b>To Reheat using "Sensor Reheat" Pad</b> <small>(☞ page 13)</small>	 <p>Press once                      optional                      Press</p>			
<b>To Use as a Kitchen Timer</b> <small>(☞ page 14)</small>	 <p>Press once                      Set Kitchen time.                      Press</p>			
<b>To Set Standing Time</b> <small>(☞ page 14)</small>	<p><b>Set the desired cooking program.</b> (See Page 9) → Timer/Clock → 0 to 9 → Start</p> <p style="text-align: center;">Press once                      Set Standing time.                      Press</p>			
<b>To Set Delay Start</b> <small>(☞ page 14)</small>	 <p>Press once                      Set Delay time.                      Press</p>			

Microwaves penetrate the surface of the food to a depth of about two to three centimetres and then the heat is gradually conducted in a random pattern. Some parts of food matter cook faster than others. Special microwave techniques are used to promote

fast and even cooking. Some of these techniques are similar to those used in conventional cooking, but because microwaves produce heat very quickly the following techniques are extremely important. It's a must for you to be familiar with the following tips.

---

## Food Characteristics

---

### Size and Quantity

Small portions cook faster than large portions. As you increase the quantity of food you put into the microwave oven, you must also increase your cooking time. The microwave oven has the same power regardless of quantity; thus the power is divided between more items and so it takes longer to cook.

As a general guide, if you double the quantity of food suggested in the recipe, add half the time suggested again.

### Liquid Content

Low moisture foods take a shorter time to cook than foods with a lot of moisture.

### Shape

Uniform sizes cook more evenly. To compensate for irregular shapes, place thin pieces towards the centre of the dish and thicker pieces towards the outer edge of the dish.

### Bone and Fat

Bones conduct heat and cause the meat next to them to be heated more quickly. Large amounts of fat absorb microwave energy and the meat next to these areas may overcook.

### Starting Temperature

Food which has been sitting at room temperature takes less time to cook than refrigerated or frozen food.

### Density and Composition

Porous, airy foods (cakes and breads) take less time to cook than heavy compacted foods (meat and vegetables). Recipes high in fat and sugar content cook more quickly.

---

## Techniques for Preparation

---

### Timing

A range of cooking times is given in each recipe for two reasons. First, to allow for the uncontrollable differences in food shapes, starting temperatures and personal preferences. Secondly, these allow for the differences in electrical voltage input which changes during peak load periods. Always remember that it is easier to add time to undercooked food. Once the food is overcooked, nothing can be done. For each recipe, an approximate cooking time is given.

### Stirring

Stirring is often necessary during microwave cooking. We have noted when stirring is helpful in the recipes. Always bring the outside edges towards the centre and the centre portions to the outside.

### Rearranging or Turning

Some foods should be turned in the container during cooking. For example, because of the different thicknesses in the breast and back sections of poultry, it is a good idea to turn poultry over once to ensure more even cooking. Rearranging or turning over uneven shaped food in the dish should be done as suggested to ensure a satisfactory result. Rearrange small items such as chicken pieces, prawns, hamburger patties, nuts or potatoes. Rearrange pieces from the centre to the edge of the dish.

### Cooking in Layers

This microwave oven is not designed to cook more than 1 layer of food. Cooking in 2 layers may not always be successful, it takes longer and may be uneven. You can successfully reheat two dinner plates of food at one time but remember to increase the reheating time and use a microwave warming rack.

### Piercing of Foods

Pierce the skin or membrane of foods such as eggs, tomatoes and jacket potatoes when cooked whole in the microwave oven. This allows steam to escape. If the skin has not been pierced, food may burst.

### Cured Meats

Cured meats may overcook in some areas due to the high concentration of salts used in the curing process. So take care when cooking different brands of bacon as cooking times may vary slightly.

## Techniques for preparation

### Covering

Covering food minimizes the microwave cooking time.

Because microwave cooking is done with time and not direct heat, the rate of evaporation cannot be easily controlled. However, this can be corrected by using different materials to cover dishes. Plastic wrap is the best substitute for a lid as it creates a tighter seal and so it retains more heat and steam. Wax paper and paper towels hold the heat in but not the steam. These materials also prevent splattering. Use a paper towel, wax paper or no cover when steam is not needed for tenderising.

### Browning

Meats and poultry, when cooked longer than 10 to 15 minutes, will brown from their own fat. Foods cooked for shorter periods of time can be aided with the help of a browning sauce, worcestershire sauce or soy sauce. Simply brush one of these sauces over meat or poultry before cooking. Baked goods do not need long cooking times and therefore, do not brown. When cakes or cupcakes are iced, no one will notice the visual difference. For cakes or cupcakes, brown sugar can be used in the recipe in place of caster sugar or the surface can be sprinkled with dark spices before baking.

### Standing Time

The moisture molecules continue to vibrate in the food when the microwave oven has turned itself off. After all, the molecules were vibrating at 2,450,000,000 times per second during cooking. So cooking continues even after the food is no longer being exposed to the microwaves whether in or outside your microwave oven.

Standing time refers to the time it takes (after the microwave time is completed) to allow the interior of the food to finish cooking.

The amount of standing time varies with the size and density of the food. In meat cookery, the internal temperature will rise between 5°C and 10°C if allowed to stand covered for ten to fifteen minutes. Rice and vegetables need shorter standing time, but this time is necessary to allow foods to complete cooking in the centre without overcooking on the edges.

The power level used in microwave cooking also determines the standing time. For example, when using a lower power level the standing time is shorter because of a lower concentration of heat in the food. Foods should always be kept covered while standing in order to retain the heat. If a longer standing time is required (while you cook another food to serve with the first, for instance), cover with aluminum foil.

## Converting Your Favourite Conventional Recipes for Microwave Cooking

When adapting conventional recipes for microwave cooking, time are reduced considerably.

For example, A chicken which takes 1 hour to cook in a moderate oven will take 15 to 20 minutes on P7 Power in your microwave oven.

Use similar microwave recipes to help you adapt conventional recipes. Remember, it is always best to undercook a recipe and then add an extra minute or two to finish it off.

Here are some other tips that may help:

- Reduce liquids in a conventional recipe by one half to two thirds, e.g. 1 cup (250 ml) should be reduced to ½ cup (125 ml).
- Add more thickening such as flour or cornflour to sauces and gravies if you do not reduce the liquid.
- Reduce seasonings slightly in a recipe where ingredients do not have time to simmer by microwave.
- Do not salt meats, poultry or vegetables before cooking; otherwise, they will toughen and dry out.
- If one ingredient takes longer to cook than the others, pre-cook it in the microwave oven first. Onion, celery and potato are examples.
- When cooking meat or vegetables, omit any oil or fat that would have been used in a conventional recipe for browning.
- Reduce leavening agents for cakes by one quarter and increase liquids by one quarter.
- Biscuits require a stiff dough. Increase flour by about 20 percent. Substitute brown sugar for white sugar and use biscuit recipes that have dark spices or require icing. Because of the short cooking time, biscuits don't have time to brown. Chill dough for half an hour before baking. This produces a crisper biscuit. Bake biscuits on a glass tray lined with greaseproof paper.
- Since microwaves penetrate foods about two centimetres from the top, bottom and sides, mixtures in round shapes and rings cook more evenly. Corners receive more energy and may overcook.
- Items with a lot of water, such as rice and pasta, cook in about the same time as they would on a conventional stove. (Refer to **Rice** and **Pasta** chapter.)

Select recipes that convert easily to microwave cooking such as casseroles, stews, baked chicken, fish and vegetable dishes. The results from foods such as grilled meats, cooked souffles or two-crust pies could be less than satisfactory. Never attempt to deep fry in your microwave oven.



---

## Menu Planning for Microwave Cooking

---

### How to Keep Everything Hot at The Same Time

Plan your meals so that the food will not all need last minute cooking or attention at the same time. The special features of microwave cookery make it easy to serve meals with everything piping hot. Cooking of some foods may be interrupted while you start others, without harming the nutritional value or flavour of either.

A recipe which requires standing time can be microwaved first and another food cooked while it stands. Dishes prepared in advance can be reheated briefly before serving.

It does take some experience and time to cook with confidence. Microwaves are fast so you will have to do some experimenting. You might find you will use your conventional range in conjunction with your microwave oven. For example, while cooking the roast in the microwave oven, you can be cooking the vegetables and gravy on the range top. This can also be done the other way around. Prepare your meals as follows.

1. Firstly, cook the most dense item (roast or casserole). Drain and retain meat juice from joints then cover with foil.
2. Cook the potatoes, rice or pasta.
3. Cover with foil for standing.
4. Cook greens and other vegetables.
5. Cover with foil for standing.
6. Cook the gravy with the retained meat juices, stock and thickening.
7. Carve the roast and serve the vegetables and gravy.

While you are learning to plan meals, you may get a bit behind time. Don't worry. Dinner servings may be reheated on P7, for 1 to 2 minutes per serving. If you prefer not to use foil, cover food with saucepan lids. A metal lid will retain the heat for at least 15 minutes.

Meanwhile, how can you cook all the vegetables at the same time? Simply place potatoes and pumpkin in one dish and less dense vegetables such as broccoli, cabbage, cauliflower, beans and peas in another. Sprinkle greens with water. Cover with a lid or plastic wrap. Cook on P10 for cooking times refer to vegetable cooking chart on page 37. Fresh and frozen vegetables can be mixed on a vegetable platter, but remember frozen vegetables are not as dense as fresh vegetables, as they have been blanched before freezing.

If vegetables are cut to a similar size, they can be cooked in separate ramekins or small dishes at the same time.

---

## Increasing & Decreasing Recipes

---

### Increasing

- To increase a recipe from 4 to 6 servings, increase each ingredient listed by half.
- To increase a recipe from 4 to 8 servings, double each ingredient listed.
- For larger quantities of a recipe, a large dish should be used. Make sure that the dish is deep enough to prevent the recipe from boiling over during cooking.
- Make sure to cover, stir or rearrange food as directed in the recipe and always check the food during cooking.
- Increase standing times by 5 minutes per 500g.
- Use the same Power Level recommended in the original recipe.
- Increase the cooking times by:  $\frac{1}{3}$  of original cooking time for 6 servings; and an extra  $\frac{1}{2}$  of original cooking time for 8 servings.

### Decreasing

- To decrease a recipe from 4 to 2 servings, decrease each ingredient listed by half.
- For small quantities, a small dish should be used. Make sure that the dish is large enough to prevent the recipe from boiling over during cooking.
- Use the same Power Level recommended in the original recipe.
- Decrease the cooking times by  $\frac{1}{2}$  to  $\frac{2}{3}$  of the original cooking time.

---

### Cooking for One

---

- To decrease a recipe from 4 to 1 serving, quarter each ingredient listed.
- A smaller dish should be used, making sure that the dish is still large enough to prevent the recipe from boiling over.
- Use the same Power Level recommended in the original recipe.
- Quarter the original cooking times, then add extra time, if needed.
- Make sure to cover, stir or rearrange food as directed in original recipe and always check the food during cooking.

---

### Converting Recipes from Other Sources

---

When the recipe is written with a wattage different than your oven, adjust the cooking time by approximately 10% per 100 watts, e.g. 6 minutes would be adjusted by 36 seconds. Alternately, adjust the power level by one level. If your wattage is higher than the recipe: (1) Adjust time downward or (2) Adjust power level downward. If your wattage is lower than the recipe: (1) adjust time upward or (2) adjust power level upward (when possible).

## Converting recipes from other sources

One of the most common uses for a microwave oven is to reheat food. Your Panasonic microwave allows you to either reheat by placing food into the oven and you choose the micro power level and length of heating time or you may reheat automatically by using the SENSOR REHEAT Pad on your microwave. Following are some directions for reheating pre-cooked foods from either frozen refrigerator temperature or room temperature.

### General rules for reheating foods by Micro Power

- Many convenience foods contain heating instructions on the packaging. It is best to follow these instructions, being sure to check the wattage of the oven they used and adjust the cooking time if necessary (decrease cooking time by 10% for every 100watts more powerful your oven is).
  - If package directions are not available, follow the recommendations in the charts on the following pages.
  - All foods must be pre-cooked; raw foods will not cook through during reheating times and if consumed may cause illness.
  - Do not reheat in foil containers, cans or plastic containers as incorrect heating times will result. Place foods into microwave safe bowls or onto dinner-plates before heating.
  - Most foods can be heated on P10 but consider if the food is delicate in structure like baked custard or you have a large quantity, a lower power level for slightly longer may be gentler.
  - Cover foods with plastic wrap if you require a steamed effect or leave uncovered for a drier surface, e.g. Crumbed foods.
- Note:** when cooking by Sensor Cook all food must be covered.
- Stir or re-arrange foods during heating as this will help food heat evenly. Stir after heating and let stand for 2 to 3 minutes. Check temperatures before adding extra heating time and ensure food is hot. If food is not heated enough, consumption may cause illness.

#### Caution:

Pastry items which have a filling that is high in fat., sugar or moisture will become hotter in the centre and the pastry may only feel warm. Ensure you allow it to stand for several minutes before eating.

## Reheating by Sensor Cook (125 g - 1.0 kg)

- Reheating by Sensor is suitable for pre-cooked foods. There is a setting for frozen and refrigerator temperature or room temperature foods. It is suitable for casseroles, plated meals, soup, stews, pasta dishes (except lasagne) and canned foods.
- Do not reheat bread or pastry products, raw uncooked food or beverages on Sensor Reheat.
- Foods greater than 1 kg or smaller than 125 g should be cooked by micro power and time.
- Follow general directions for heating as above.
- Cover foods securely with plastic wrap or a fitted lid, which does not snap seal.
- During the heating time, the oven will 'beep' and prompt you to stir/rearrange the food. There is no need to recover if not required.
- After heating, stir the food, check it is hot and allow standing for 2 to 3 minutes.

**To Operate:** Press then Press **Start**.

Sensor Reheat
------------------

## Reheating by Micro Power - Frozen Pre-cooked Foods

FROZEN ITEM (Pre-cooked)	POWER	TIME (in minutes)	SPECIAL INSTRUCTIONS
<b>BREAD &amp; BAKED PRODUCT</b>			
Bread 1 slice	P7	10 - 15 sec	Do not let bread get hot, or it will become rubbery and dry out. Remove whole loaf from original wrapper. Place on paper towel to absorb moisture.
1 loaf	P7	1 - 3	
6 rolls	P6	1 - 2	
Cheesecake (450g)	P3	5 - 7	Remove from container. Defrost on plate.
Muffins - 4 (400 g)	P7	1½ - 2	Place onto paper towel lined plate.
Scones - 6 (400 g)	P6	1½ - 2	Defrost on paper lined plate. Stand 2 minutes.
<b>PIES</b>			
Fruit Pie (600 g)	P3 then P7	5 - 7  5 - 7	Remove from foil container and place uncovered into a pie dish.
Meat Pie (175g)	P7	4 - 5	Place onto paper towel lined plate.
Pizza (350 g)	P10	5 - 7	Remove from package and place onto paper towel or follow manufacturer's instructions.
<b>FROZEN MEAL</b>			
Fish in Sauce (200 g)	P5	5 - 7	Pierce corner of bag. Heat on a plate.
Frozen Casserole (500g)	P10	9 - 11	Pierce pouch. Heat on a plate or bowl.
Lasagne (500 g)	P9	11 - 13	Remove from foil container, place into serving dish.
Plated style dinner (320 g)	P5	8 - 10	Remove foil cover and replace with plastic wrap.
Vegetables & Sauce (in the bag) (500 g)	P7	6 - 8	Pierce corner of bag. Heat on a plate.
<b>MISCELLANEOUS</b>			
Chicken Pieces (500 g)	P7	8 - 10	Place onto paper towel lined plate.
Chicken Nuggets (12)	P7	3 - 4	Place onto paper towel lined plate.
Croissants - 4 (200 g)	P3	1 - 1½	Place onto paper towel lined plate.
Fish Fingers - 8 (200 g)	P3 then P10	2 - 4  2 - 3	Place onto paper towel lined plate.
Sausage Rolls (225 g)	P5	2 - 3	Place onto paper towel lined plate.

## IMPORTANT POINTS TO CONSIDER WHEN REHEATING COLD FOODS

### STARTING TEMPERATURE —

Foods taken from the refrigerator will take longer to reheat than foods from room temperature.

### Quantity —

One serving heats faster than several servings. When heating large quantities, stir food to ensure even heating. It is quicker to heat individual plates of food than large quantities in a casserole dish.

### Plated Dinners —

Arrange foods with the most dense items towards the outside of the plate. Cover meats with sauces/gravies if desired, spread out mashed potatoes or rice so it heats more evenly. When assembling plates of leftover foods, use foods which have a similar starting temperature.

### Covering Foods —

Most foods need to be covered with one sheet of absorbent paper towel to hold in the heat and prevent splattering without steaming. When more moisture is desired, cover with plastic wrap.

### Heating —

Reheating is usually done on P10, however, if food has a more delicate texture, like a baked custard, a lower power setting should be used. P7 for a little longer will be gentler on the food. An average plate of food would generally take 1 to 3 minutes to heat depending on the density of the food. Place it in for the minimum time and add extra heating time if required.

Ensure food is hot by feeling the bottom of the plate in the centre. If the plate is cool, food may be warm but will lose heat quickly as the plate will absorb the heat and taste cold when served.

If food is not heated enough, consumption may cause illness.

### Elevation —

Elevate pastries and breads on a small plastic rack with paper towel under the food to prevent it from becoming soggy.

#### Caution:

Pastry items which have a filling that is high in fat, sugar or moisture will become hotter in the centre and the pastry may only feel warm. Ensure you allow it to stand for several minutes before eating.

## IMPORTANT POINTS TO CONSIDER WHEN REHEATING FOODS FROM THE FREEZER

### VOLUME —

The greater the volume and the more dense the item, the longer it takes to reheat. E.g. frozen cake will take less time than frozen casserole.

### LARGE VOLUME —

Large, dense, frozen precooked foods are best thawed on defrost until icy in the centre then heated on P7. This prevents overcooking of the edges. Stirring is often needed to distribute heat evenly.

### Commercial frozen foods —

These foods should be removed from their foil containers if possible and placed into suitable microwave safe containers. If a foil container is used in the microwave oven it shouldn't be more than 4 cm high and must not touch the interior of the microwave oven. Remove the cover from the tray and replace with paper towel or plastic wrap to prevent splattering.

### Foods to be served at room temperature —

For best results, defrost for a short time and allow to stand to complete thawing, e.g. frozen cake.

### Vacuum sealed pouches —

Pierce pouches, bags before heating to allow steam to escape. This prevents bursting.

### Containers —

Use dishes about the same volume of the food or slightly larger to allow for stirring. Remove or release snap seal lids other wise they will pop during heating and may disfigure.

### Pies and pastries —

Pies and pastries that contain raw pastry and filling cannot be cooked in the microwave oven. Pre-cooked products can be thawed and heated. Place them on a sheet of paper towel and elevate on plastic rack for best results. For added crispness place under the grill or in a hot oven for few minutes. Pastry items can become tough and rubbery if overheated, remember to allow 5 minutes standing then test before adding extra heating time.

---

## PUMPKIN SOUP

---

Serves: 4

### Ingredients:

1 kg	diced pumpkin
1	onion, diced
2 cups	chicken stock
1 teaspoon	curry powder
	pepper

### Method:

Place pumpkin, onion and curry powder in a 2-litre casserole dish. Cover and cook on P10 for 12 minutes. Add chicken stock and pepper. Cook on P10 for 10 minutes. Cool slightly. Purée pumpkin and liquid in blender or food processor. Pour into individual serving dishes and garnish with chives.

### To cook by Sensor Cook:

Prepare pumpkin as above cover with plastic wrap. Refer to Potatoes directions on page 39.

---

## SHORT AND LONG SOUP

---

Serves: 4

### Ingredients:

200 g	fresh singapore noodles
12 (200 g)	frozen mini dim sims
4	green onions, sliced
1 litre	chicken stock
1 teaspoon	crushed garlic
½ teaspoon	chopped fresh ginger
2 tablespoons	soy sauce
1	chicken breast, cooked and sliced
4	baby bok choy, quartered
1 cup	bean sprouts
2 tablespoons	dried onion (optional)

### Method:

Place all ingredients except bok choy and bean sprouts in a 4 litre casserole dish and cook on P10 for 10 minutes. Add bok choy and cook on P10 for 2 minutes. Serve in individual bowls topped with bean sprouts and onion.

### Hint:

To cook 1 double chicken breast. Place onto a dinner plate. Cover and cook on P7 for 8 to 10 minutes.

---

## PEA AND HAM SOUP

---

Serves: 6

### Ingredients:

2½ cups	green split peas
850 g	smoked ham hock
1 medium	onion, chopped
1 tablespoon	fresh thyme leaves
1	bay leaf
6 cups	chicken stock
½ cup	frozen peas

### Method:

Wash split peas and place in a 2-litre capacity bowl with 1-litre of water. Cover and allow soaking for 8 hours or overnight. Remove rind from ham hock and discard. Cut meat away from the bone and roughly chop. Reserve bone. Drain peas and place into a 5-litre capacity microwave safe dish. Add ham bone, chopped ham, onion, thyme, bay leaf and chicken stock. Cook uncovered on P10 for 15 minutes. Reduce power to P6 and cook for 15 minutes. Skim top of soup and cook on P6 for a further 30 minutes. Remove ham bone and bay leaf and stir in frozen peas. Cook on P6 for 10 minutes. Blend half the soup and return to the bowl, stirring through the remaining soup. Serve hot with crusty bread.

### Tip:

Substitute 500 g bacon bones and 250 g of diced bacon rashers for the ham hock. Do not add salt when cooking lentils or pulses, as they will toughen. Add salt after cooking if desired.

---

## POTATO AND LEEK SOUP

---

Serves: 4 to 6

### Ingredients:

1 kg	potatoes, peeled and diced
2 medium	thinly sliced leeks
2 teaspoons	fresh thyme
	pepper
3 cups	chicken stock
150 ml	cream

### Method:

Place potatoes, leeks, thyme and pepper in 4-litre casserole dish. Cover and cook on P10 for 8 minutes. Stir in chicken stock. Cover and cook on P10 for 14 to 16 minutes. Purée soup mixture. Stir in cream and serve hot or cold in individual bowls.

### To cook by Sensor Cook:

Place potatoes, leeks, thyme and pepper in a 4-litre dish. Cover with plastic wrap. Refer to Potatoes directions on page 39.



**CHICKEN AND PRAWN LAKSA**

Serves: 4

**Ingredients:****Soup:**

2 tablespoons laksa paste  
 400 ml coconut milk  
 1 litre chicken stock  
 1 tablespoon soy sauce  
 fresh ground black pepper

**Laksa:**

250 g rice noodles  
 8 cups boiling water  
 1 bunch coriander, leaves chopped  
 4 small red chillies, seeds removed  
 and finely chopped  
 1/2 cup bean sprouts  
 4 limewedges  
 1 tablespoon peanut oil  
 400 g cooked chicken tenderloins, sliced  
 12 green king prawns, peeled

**Method:****Soup:**

Place the laksa paste, coconut milk, stock, soy sauce and pepper into a 3-litre dish and cook covered on P10 for 8 to 10 minutes.

**Laksa:**

Place the noodles and water in a 4 litre dish. Cover and cook on P10 for 2 to 3 minutes, stirring halfway through. Drain well and divide between 4 deep bowls. Place the coriander, chillies, bean sprouts and lime on top. Place the peanut oil and prawns in a 1-litre dish and cook on P7 for 3 to 5 minutes, stirring halfway through. Add the chicken and prawns to each individual bowl and set aside.

**To serve:**

Heat soup on P10 for 2 minutes. Pour the hot soup over the ingredients in the 4 bowls and serve.

**ZUCCHINI SLICE**

Serves: 4 to 6

**Ingredients:**

4 rashers bacon, diced  
 1 onion, diced  
 2 cups grated zucchini  
 2 cups grated carrot  
 1 cup grated tasty cheese  
 1 cup self raising flour  
 5 eggs, lightly beaten  
 125 ml vegetable oil  
 1 tablespoon fresh chopped parsley  
 salt and pepper

**Method:**

Lightly grease a 25 cm square microwave safe dish. Place bacon and onion in a 2-litre casserole dish and cook on P10 for 2 to 3 minutes. Allow to cool slightly. Stir in zucchini, carrot and cheese and flour. In a 1-litre bowl whisk together eggs, oil and parsley. Add to bacon mixture season with salt and pepper and stir until combined. Pour into prepared dish. Cook on P6 for 22 to 24 minutes.

**NACHOS SUPREME**

Serves: 4 to 6

**Ingredients:**

500 g topside mince  
 35 g taco seasoning mix  
 1/3 cup tomato paste  
 1 teaspoon Mexican chilli powder  
 310 g red kidney beans, mashed in liquid  
 180 g corn chips  
 1 avocado  
 1/2 cup sour cream  
 1/2 cup grated cheese  
 paprika

**Method:**

Place meat in a 2-litre dish. Cook on P7 for 6 minutes, stirring halfway through. Mix with fork, breaking up any large pieces of meat. Add taco mix, tomato paste, chilli powder and kidney beans. Cook on P7 for further 10 minutes, stirring halfway through cooking. Place corn chips in a 3-litre microwave suitable serving dish. Pile meat sauce in the centre. In a small bowl, mash avocado and mix in sour cream. Spoon this mixture over meat sauce and top with grated cheese. Sprinkle with paprika. Heat on P7 for 3 to 4 minutes.

**NUTS AND BOLTS**

Serves: 6 to 8

**Ingredients:**

80 g butter  
 2 teaspoons curry powder  
 2 tablespoons worcestershire sauce  
 1/2 teaspoon salt  
 1/4 teaspoon garlic powder  
 100 g mixed rice crackers  
 100 g fried noodles  
 200 g salted peanuts  
 125 g pretzel sticks  
 1/2 cup Nutri-Grain

**Method:**

Place butter, curry, worcestershire sauce, salt and garlic powder in a 3-litre casserole dish. Cook on P10 for 1 to 2 minutes. Add remaining ingredients, mix well and cook on P10 for 4 to 5 minutes. Stir twice through cooking. Allow to cool. Place in a bowl and serve with drinks. Store in an airtight container once cool.

## Cooking Fish and Shellfish by Micro Power

Clean fish before starting the recipe. Arrange fish in a single layer, overlap thin fillet ends to prevent overcooking. Prawns and scallops should be placed in a single layer.

Cover dish with plastic wrap. Cook on the power level and the minimum time recommended in the chart below. Halfway through cooking rearrange or stir prawns, fish fillets or scallops.

### Cooking Fish and Shellfish using Micro Power

FISH OR SHELLFISH	AMOUNT	POWER	APPROX. COOKING TIME (in minutes)
Fish Fillets	500 g	P4	8 to 10
Scallops (sea)	500 g	P4	6 to 8
Green Prawns medium size (shelled and cleaned)	500 g	P4	7 to 9
Whole Fish (stuffed or unstuffed)	500 g to 600 g	P4	7 to 10

### Directions for cooking fish by Sensor Cook

- Suitable for cooking whole fish and fish fillets.
- Select fish suitable for microwave cooking and place in a single layer in a shallow dish, with skin-side down.
- Add butter, spices, herbs, or lemon juice to flavour.
- Overlap thin edges of fillets to prevent overcooking.
- Shield the eye and tail area of whole fish with small amounts of aluminum foil to prevent overcooking.
- During the cooking time, the oven will 'beep' and prompt you to turn over/rearrange.
- Allow large amounts of fish to stand for 3 to 5 minutes after cooking before serving.

#### To Operate for Sensor Cook (125g - 500g):

Cover dish securely with plastic wrap or fitted lid. Select **Fish**, then **Start**.

### LEMON PEPPER FISH

Serves: 2

#### Ingredients:

350 g fish fillets  
 ¼ cup lemon juice  
 1 teaspoon cracked black pepper

#### Method:

Place fish, lemon juice and cracked black pepper in 1-litre casserole dish. Cook on P4 for 4 to 6 minutes. Let stand for 3 minutes before serving.

#### To cook by Sensor Cook:

Prepare as above. Cover with plastic wrap. Select **Fish**, then **Start**.

### GARLIC & CHILLI PRAWNS

Serves: 4

#### Ingredients:

1 kg medium uncooked king prawns  
 1 small red onion, thinly sliced  
 40 g butter  
 3 garlic cloves, crushed  
 2 fresh bird's eye chillies, deseeded & finely chopped  
 ½ small red capsicum, finely sliced  
 100 g snow peas, trimmed  
 1 tablespoon lemon juice  
 80 ml thickened cream  
 ¼ cup coriander leaves, chopped  
 Cooked jasmine rice, to serve

#### Method:

Peel and de-vein prawns leaving tails in tact, set aside. Place onion, butter, garlic and chilli into a 3 litre microwave safe dish. Cook on P10 for 4 minutes, stir halfway through cooking. Add prawns and mix to combine. Cook on P7 for 3 minutes. Stir in capsicum and snow peas, cover and cook on P7 for a further 3 minutes. Stir through lemon juice, cream and coriander, season and cook on P10 for 1 minute. Serve immediately with cooked rice.

**TOMATO BASIL MUSSELS**

Serves: 4

**Ingredients:**

1 kg	fresh mussels
¼ cup	water
1 tablespoon	olive oil
1	leek, sliced
1	clove garlic, crushed
1 (425 g)	can tomato pieces
1 tablespoon	tomato paste
½ teaspoon	oregano
2 tablespoons	chopped fresh basil
	freshly ground black pepper

**Method:**

Place mussels and water into a bowl. Cover and cook on P7 for 4 to 6 minutes. Set aside. Place oil, leeks and garlic into a 3-litre dish. Cook on P10 for 2 minutes. Stir well, add tomatoes, tomato paste, oregano, basil and pepper. Mix well. Cook on P10 for 3 to 4 minutes. Add mussels. Cover and cook on P10 for 2 to 3 minutes. Serve immediately.

**BOUILLABaisse**

Serves: 4 to 6

**Ingredients:**

2 tablespoons	olive oil
2	onions, sliced
1	large leek, sliced
4	cloves garlic, crushed
425 g	tomato pieces
½ cup	tomato paste
4 cups	hot fish stock
⅓ cup	dry white wine
1 tablespoon	fresh thyme leaves
½ teaspoon	saffron powder
1 teaspoon	chilli powder
	freshly ground black pepper
	salt
500 g	firm fish fillets, chopped
500 g	green prawns meat de-veined

**Method:**

Place oil, onions, leek and garlic in a 4-litre dish. Cover and cook on P10 for 6 to 8 minutes. Stir halfway through cooking. Add tomatoes, tomato paste, fish stock, wine, thyme, saffron, and chilli powder. Season with salt and pepper. Cook on P10 for 12 minutes. Add fish fillets and prawns. Cook on P10 for 8 to 10 minutes or until seafood is cooked. Serve garnished with fresh thyme.

**GARLIC PRAWNS**

Serves: 2

**Ingredients:**

60 g	butter
2 cloves	garlic, minced
1 tablespoon	lemon juice
1 tablespoon	chopped parsley
500 g	peeled green prawns

**Method:**

Place butter and garlic in a 1-litre dish and cook on P10 for 30 to 50 seconds. Add lemon juice, parsley and prawns. Cook on P6 for 5 to 7 minutes, stirring halfway through cooking. Serve in individual ramekins.

**SALMON STEAKS WITH LIME BUTTER**

Serves: 4

**Ingredients:**

30 g	butter
1	clove garlic, crushed
1 teaspoon	grated fresh ginger
1 teaspoon	grated lime rind
2 tablespoons	lime juice
½ teaspoon	sugar
500 g	salmon, steaks

**Method:**

Place butter, garlic, ginger, lime rind, juice and sugar in a shallow dish. Cook on P7 for 1 to 2 minutes. Stir halfway through cooking. Add salmon steaks and coat with sauce. Cover and cook on P5 for 5 to 7 minutes. Stand for 2 to 3 minutes before serving.

**To cook by Sensor Cook:**

Prepare as above. Cover with plastic wrap. Select **Fish**, then **Start**.

**OYSTERS KILPATRICK**

Makes: 12

**Ingredients:**

2 rashers	bacon finely chopped
1 tablespoon	worcestershire sauce
2 teaspoons	lemon juice
1 tablespoon	barbecue sauce
12	oysters in shell

**Method:**

Spread bacon onto a dinner plate. Cover with paper towel and cook on P10 for 2 to 3 minutes. Mix together worcestershire sauce, lemon juice and barbecue sauce. Place oysters in shell evenly around dinner plate and sprinkle with bacon mixture. Pour some sauce mixture over each oyster. Cook on P10 for 1 to 1½ minutes. Serve with drinks or as an entree.

**SEAFOOD MARINARA**

Serves: 4

**Ingredients:**

750 g	Marinara mix
2 tablespoons	butter
1	clove garlic, crushed
2	tomatoes, peeled and chopped
1 tablespoon	tomato paste
¼ cup	white wine
¼ cup	fresh basil leaves, chopped
	pepper

**Method:**

Place marinara mix into a 2-litre casserole dish. Set aside. Place butter and garlic in 1-litre casserole dish. Cook on P7 for 1 minute. Add remaining ingredients (except seafood), to dish and cook on P10 for 5 minutes. Purée tomato mixture in blender or food processor and pour over seafood. Cook on P6 for 7 to 9 minutes, stir halfway through cooking. Stand for 5 minutes. Serve with salad and pasta.

## Cooking Whole Poultry by Micro power

Season as desired, but salt after cooking. Browning sauce mixed with equal parts of butter will enhance the appearance.

Poultry must be unstuffed. Tie legs together with cotton string. Place on a microwave rack set in a rectangular dish. Place poultry breast-side down: turn over halfway through cooking. Cover with wax paper to prevent splattering.

If the poultry is not cooked enough, return it to the oven and cook a few more minutes at the recommended power level.

**DO NOT USE A CONVENTIONAL MEAT THERMOMETER IN THE MICROWAVE OVEN.**

Let stand, covered with foil, 10 to 15 minutes after cooking. Standing time allows the temperature to equalize throughout the food and finishes the cooking process.

If a large amount of juice accumulates in the bottom of the baking dish, occasionally drain it. If desired, reserve juices for making gravy.

Less-tender birds should be cooked in liquid such as soup or broth. Use ¼ cup per 500g of poultry.

Use an oven cooking bag or a covered casserole.

Select a covered casserole deep enough so that bird does not touch the lid.

If an oven cooking bag is used, prepare according to package directions. Do not use wire twist-ties to close bag. Use only nylon tie, a piece of cotton string, or a strip cut from the open end of the bag.

Make six 2 cm slits on top of bag.

Multiply the weight of the poultry by the minimum recommended minutes per 500 g. See chart below. Programme Micro Power and Time.

After cooking, check the internal temperature of the bird with a microwave or conventional meat thermometer inserted into the muscle. Check temperature in both muscles. The thermometer should not touch bone. If it does, the reading could be inaccurate. A thermometer cannot be accurately inserted into a small bird. To check desired cooking of a small bird, juices should be clear and the drumsticks should readily move up and down after standing time.

During cooking, it may be necessary to shield legs, wings and the breast bone with foil to prevent overcooking. Wooden toothpicks can be used to hold foil in place.

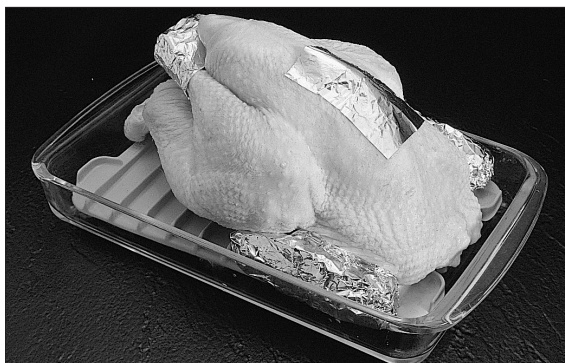

## Cooking Poultry Pieces by Micro power

Cover with wax paper or paper towel. Use the chart below to determine recommended minimum cooking times.

Arrange pieces skin-side down and evenly spread in a shallow dish.

Turn or rearrange halfway through cooking. Shield wing tips, drumstick ends etc., if required.



### **Cooking Poultry by Micro power**

<b>POULTRY</b>	<b>POWER</b>	<b>TEMPERATURE AFTER COOKING</b>	<b>APPROX. COOKING TIME (minutes per 500g)</b>
Chickens (up to 2 kg)	P7	87°C	10 to 15
Chicken (pieces)	P7	87°C	8 to 10
Turkey	P7	87°C	12 to 17
Duck	P7	87°C	10 to 15

---

### Cooking Chicken Pieces by Sensor Cook

---

- **Minimum weight 400g / Maximum weight 1.0 kg**
- Suitable for cooking chicken pieces, such as wings, thighs, legs, breast fillets.
- Chicken pieces should be completely thawed before cooking.
- Marinate chicken pieces before cooking for added flavour and colour.
- Arrange chicken pieces skin side down with thicker, meatier portions towards the edge of dish.
- Cover dish securely with plastic wrap.
- During the cooking time, the oven will 'beep' and instruct you to 'Turn over/Rearrange'. Remove the plastic wrap completely from dish. There is no need to re-cover.
- Let stand 5 to 10 minutes at the completion of cooking.

**To Operate:** Select **Chicken Pcs**, then press **Start**.

---

### SCRAMBLED EGGS

---

Serves: 2

#### Ingredients:

2 x 60 g	eggs
2 tablespoons	milk
	pinch of salt

#### Method:

In a 1-litre casserole dish, beat eggs lightly with whisk. Add milk and salt. Whisk until well combined. Cover dish with plastic wrap and cook on P6 for 1 to 1½ minutes. Stir eggs and cook for further 1 to 1½ minutes. Stand, covered, for 1 minute before serving.

---

### Cooking Eggs by Micro power

---

**Boiled Eggs:** Do not boil eggs in your microwave. Raw eggs boiled in their shells can explode and cause serious injury.

**Poached Eggs:** The membrane on egg yolks must be pierced before cooking, otherwise steam will build up and cause yolk to pop.

**Scrambled Eggs:** Slightly undercook scrambled eggs as they will finish cooking during standing.

---

### POACHED EGGS

---

Serves: 2

#### Ingredients:

2 x 60 g	eggs
½ cup	hot tap water
	dash of vinegar
	pinch of salt

#### Method:

Place one quarter of cup of water, dash of vinegar and pinch of salt into 2 ramekin dishes or small glass bowls. Heat water on P10 for 30 - 60 seconds. Break egg into the water and with toothpick pierce the egg yolk twice and egg white several times. Cover dishes with plastic wrap and cook on P6 for 1 to 1½ minutes.

Stand, covered, for 1 minute before serving.

**Note:** The size of the eggs will alter cooking time.

---

## GREEN PEPPERCORN CHICKEN

---

Serves: 4

### Ingredients:

500 g	sliced chicken breast fillets
2 tablespoons	green peppercorns
1 tablespoon	seeded mustard
1 teaspoon	chicken stock powder
2 tablespoons	lemon juice
1/2 cup	cream

### Method:

Place chicken in a 3-litre casserole dish. Cook on P7 for 8 to 10 minutes stirring halfway through cooking. Mix together peppercorns, mustard, stock powder, lemon juice and cream. Pour over chicken, stir. Cook on P10 for 2 to 3 minutes.

---

## CHICKEN CURRY

---

Serves: 4

### Ingredients:

1	onion, chopped
2 tablespoons	red curry paste
500 g	chicken fillets, sliced
1 tablespoon	fish sauce
1 tablespoon	brown sugar
2 cups	finely sliced vegetables
1 cup	coconut milk

### Method:

Place onion and curry paste in a 3-litre casserole dish. Cook on P10 for 2 to 3 minutes. Add chicken and combine. Cook on P7 for 6 minutes, stirring once during cooking. Add fish sauce, brown sugar, vegetables and coconut milk. Stir well. Cover and cook on P10 for 4 to 6 minutes. Serve with Jasmine rice.

---

## CHICKEN CACCIATORE

---

Serves: 4

### Ingredients:

400 g	can diced tomatoes
1/4 cup	tomato paste
1 teaspoon	minced garlic
1	onion, diced
2 teaspoons	dried oregano
1 kg	chicken drumsticks
1/4	red capsicum, sliced

### Method:

Place all ingredients in a 2-litre casserole dish. Stir until combined. Cover and cook on P7 for 10 to 12 minutes. Turn chicken and stir. Cook on P7 for 10 to 12 minutes.

### HINT:

After cooking whole poultry, cover with foil to retain heat while finishing the remainder of the meal.

---

## ROAST CHICKEN

---

Serves: 4 to 6

### Ingredients:

1.5 kg	chicken
2 tablespoons	melted butter
	seasonings of your choice
	lemon, pepper, seasoned salt, etc.

### Method:

Clean and pat dry chicken with paper towel. Brush chicken with melted butter and sprinkle with seasoning. Place chicken, breast-side down, on rack in 3-litre dish. Cook on P7 for 30 to 35 minutes. Turn halfway through cooking.

---

## CHICKEN BURRITOS

---

Serves: 4

### Ingredients:

1	clove garlic, crushed
2	large onions, chopped
1 teaspoon	chilli powder (optional)
35 g	taco seasoning mix
500 g	chicken tenderloins, diced
425 g	can red kidney beans, drained
1/2 cup	tomato paste
1/2 cup	water
1 cup	grated cheese
12	tortillas

### Method:

Place garlic, onion and chilli in a 3 litre casserole dish. Cook on P10 for 2 minutes. Stir in remaining ingredients except cheese and tortillas. Cover and cook on P7 for 16 to 18 minutes, stirring twice during cooking. Serve in warmed tortillas topped with grated cheese.

---

## THAI CHICKEN WINGS

---

Serves: 3 to 4

### Ingredients:

1 kg	chicken wings
2 tablespoons	soy sauce
2 tablespoons	fish sauce
2 tablespoons	lime juice
1 teaspoon	crushed garlic
1 teaspoon	crushed ginger
1 teaspoon	crushed chilli

### Method:

Place wings into a shallow dish. Combine remaining ingredients and pour over wings. Marinate for at least 2 hours in the refrigerator. Cook on P7 for 15 to 20 minutes, rearranging halfway through cooking.

### To cook by Sensor Cook:

Prepare as above. Cover with plastic wrap. Select **Chicken Pcs**, then **Start**.



**APRICOT NECTAR CHICKEN**

Serves: 4

**Ingredients:**

400 ml	apricot nectar
40 g	French onion soup mix
1	onion, diced
1	clove garlic, crushed
1/2 cup	dried apricots
1 kg	chicken legs

**Method:**

Place all ingredients except chicken legs into a 3-litre dish. Mix well to combine. Add chicken legs and stir to coat with sauce. Cook on P7 for 20 to 25 minutes, stirring halfway through cooking.

**CHICKEN SAN CHOY BAU**

Serves: 4 to 6

**Ingredients:**

10	dried shiitake mushrooms
2 teaspoons	sesame oil
1	clove garlic, chopped
500g	minced chicken
10	water chestnuts, finely chopped
227g	can bamboo shoots, chopped
1/4 cup	soy sauce
1 tablespoon	oyster sauce
2 tablespoons	dry sherry
1	small iceberg lettuce

**Method:**

Cover mushrooms with boiling water, stand for 30 minutes. Drain, remove stems and chop finely. Place oil and garlic in a 2 litre casserole dish, cook on P10 for 40 to 50 seconds. Add chicken and cook on P7 for 5 to 6 minutes. Add remaining ingredients except lettuce and cook on P7 for 5 to 6 minutes. Separate lettuce leaves. place tablespoons of mixture into each lettuce leaf. Serve immediately.

**CHICKEN ROLLS WITH HONEY MUSTARD**

Serves: 4 to 6

**Ingredients:**

8	chicken thigh fillets
16	prunes, pitted
8	green onions, sliced
2 tablespoon	flaked almonds
4 rashers	rindless bacon, halved lengthwise

**Honey Mustard Glaze**

1 tablespoon	brown sugar
1 tablespoon	French Mustard
1 tablespoon	honey
10 g	butter, melted
	ground black pepper

**Method:**

Open out each thigh fillet and trim away fat. Place 2 prunes, some spring onion and a few flaked almonds on each fillet. Roll fillets up and wrap a piece of bacon around each one. Secure with toothpicks. Blend all glaze ingredients together in a small bowl. Place chicken into a 3-litre dish in a single layer and brush with glaze mixture. Cook on P7 for 16 to 20 minutes, turning halfway through cooking.

**CHICKEN AND ASPARAGUS RISOTTO**

Serves: 4

**Ingredients:**

300 g	fresh asparagus, chopped
2 tablespoons	olive oil
1 1/2 cups	arborio rice
1	clove garlic, crushed
4 cups	boiling chicken stock
2 cups	coarsely chopped cooked chicken
1/4 cup	grated fresh parmesan cheese
1/4 cup	cream
	ground black pepper
1 tablespoon	chopped parsley
extra	coarsely grated parmesan cheese

**Method:**

Place asparagus into 2-litre dish and cook on P10 for 1 minute. Set aside. Place oil, rice and garlic in a large microwave safe bowl. Cook covered on P10 for 1 minute. Add 2 cups of boiling chicken stock, cook on P10 for 5 minutes. Stir twice during cooking. Add remaining chicken stock and cook on P10 for another 5 minutes. Add remaining ingredients along with asparagus and stir into risotto. Cook covered on P10 for 2 minutes. Stand for 5 minutes. Serve topped with extra parmesan and black pepper.

**HONEY SESAME DRUMSTICKS**

Serves: 4

**Ingredients:**

1 kg	chicken drumsticks
1 clove	garlic, chopped
1 teaspoon	chopped ginger
1/4 cup	soy sauce
1/4 cup	honey
2 tablespoons	sesame seeds

**Method:**

Place all ingredients in 2-litre bowl, stir until combined. Marinate for at least 2 hours or overnight. Remove chicken from marinade and place in shallow dish with the meatiest ends to the outside. Cook on P7 for 15 to 18 minutes, turning once during cooking.

**To cook by Sensor Cook:**

Prepare as above. Cover with plastic wrap. Select **Chicken Pcs.**, then **Start**.

**CHICKEN WINGS IN LEMON SAUCE**

Serves: 4 to 6

**Ingredients:**

1 kg	chicken wings
1/4 cup	soy sauce
1 teaspoon	ginger powder
2	cloves garlic, crushed
1/4 cup	lemon juice

**Method:**

Place chicken wings in 3-litre casserole dish. Mix together remaining ingredients and pour over chicken wings. Marinate for 1 to 2 hours in the refrigerator. Cook, covered, on P7 for 15 to 20 minutes. Serve hot with rice.

**To cook by Sensor Cook:**

Prepare as above. Select **Chicken Pcs.**, then **Start**.

## Cooking Tender Cuts of Meat using Micro power

For best results, select roasts that are uniform in shape.

Place meat on a microwave rack in a suitable dish. Beef rib roast should be placed cut-side down. Other bone-in roasts should be placed fat-side down. Boneless roasts should be placed fat-side up. Halfway through cooking, turn roasts. Half hams should be shielded by wrapping an 8 cm wide strip of foil around the large end of the ham. Secure to the body of the ham with wooden toothpicks. Fold 3 cm over cut surface. For shank ham halves, shield shank bone by cupping it with foil. One third of the way through cooking, remove ham from oven and cut off skin. Turn fat side up and reshield edges. If desired, glaze last 10 to 20 minutes of cooking. Loosely cover baking dish with wax paper or paper towel to prevent splatter. If a large amount of juice accumulates in the bottom of the dish, drain occasionally. If desired, reserve for making gravy. Multiply the weight of the roast by the minimum recommended times per 500g. Programme Micro Power and Time. Meats can be shielded at the beginning of cooking or halfway through cooking. If you wish to shield at the

beginning of cooking, remove foil halfway through the cooking time. Beef and pork rib roasts should be shielded around the bones. Foil should extend about 5 cm down from bones. The shank and thin ends of boneless roasts should also be shielded. Make sure foil does not touch the sides of the oven, as arcing may occur. Canned hams should be shielded on the top cut-edge with a 3 cm strip of foil. Wrap strip of foil around ham and secure to body of ham with wooden toothpicks. Fold 2 cm over cut surface. After heating, check temperature using a meat thermometer. The thermometer should not touch bone or fat. If it does, the reading could be inaccurate. Lower temperatures are found in the centre of the roast and in the muscle close to a large bone, such as a pork loin centre rib roast. If the temperatures are low, return meat to the oven and cook a few more minutes at the recommended power level. **DO NOT USE A CONVENTIONAL MEAT THERMOMETER IN THE MICROWAVE OVEN.** Let stand, covered with foil, 10 to 15 minutes. During standing time the internal temperature equalises and the temperature rises 5°C to 10°C.

## Cooking Less-Tender Cuts of Meat by Micro power

Less-tender cuts of meat such as pot roasts should be cooked in liquid. Use  $\frac{1}{2}$  to 2 cups of soup, broth, etc. per 500g of meat. Use an oven cooking bag or covered casserole when cooking less-tender cuts of meat. Select a covered casserole deep enough so that the meat does not touch the lid. If an oven cooking bag is used, prepare the bag according to package directions. Do not use wire or metal

twist-ties. Use the nylon tie provided, otherwise, use a piece of cotton string or a strip cut from the open end of the bag. Make six 2 cm slits in top of bag to allow steam to escape. Multiply the weight of the roast by the minimum recommended minutes per 500g. Programme Micro Power and Time. Turn meat over halfway through cooking. Meat should be tender when cooked.

### Cooking Meat by Micro power

MEAT	POWER	APPROX. COOKING TIME (minutes per 500 g)
<b>Beef</b>		
Roasts		
Rare	P6	10 to 12
Medium	P6	12 to 14
Well	P6	14 to 16
Pot Roast	P2	25 to 30
<b>Pork</b>		
Leg of Pork	P7	11 to 13
Loin of Pork	P7	11 to 13
Ham Canned (fully cooked)	P7	4 to 5
<b>Lamb</b>		
Medium	P6	8 to 10
Well	P6	12 to 14



## Cooking Curries by Sensor Cook

(250 g - 750 g)(Weight of only meat)

- See chart below for quantities to use.
- Cut meat and vegetables into even size pieces.
- Place curry paste, meat, onion and hard vegetable into a suitable size casserole dish, do not use plastic dishes. Cover with plastic wrap. Select curries then Start.
- When the oven beeps add remaining ingredients including liquid and continue to cook, uncovered by pressing Start.
- At the end of cooking time, allow to stand for 5-10 minutes.

### To Operate for Sensor Cook:

Select **Curries**, then press **Start**.

## THAI BEEF CURRY

Serves: 4 to 6

### Ingredients:

1	onion, thinly sliced
2 tablespoons	Thai green curry paste
500 g	thinly sliced lean beef
1/2	red capsicum, thinly sliced
1	carrot, thinly sliced
1	zucchini, sliced
200 g	broccoli, broken into flowerets
1 cup	coconut milk
1 tablespoon	soy sauce
1 tablespoon	lemon juice
2 tablespoons	shredded fresh basil
1/2 cup	roasted unsalted peanuts

### Method:

Place the onion and curry paste into a 4-litre dish. Cook on P10 for 2 to 3 minutes. Add the beef and cook on P10 for 4 to 6 minutes, stirring halfway through cooking. Add the vegetables and coconut milk and cook on P10 for 6 to 8 minutes. Mix in the soy sauce, lemon juice and basil and serve sprinkled with peanuts.

## LAMB KORMA

Serves: 4

### Ingredients:

1	onion, diced
500 g	lamb, cubed
1/3 cup	korma curry paste
2 large	carrots sliced
250 ml	tomato puree
250 ml	beef stock
2 tablespoons	natural yoghurt

### Method:

Place onion, lamb, curry paste and carrot in a 3-litre casserole dish. Cook on P10 for 6 minutes. Add tomato puree and beef stock and stir, cook on P5 for 40 minutes, stirring once during cooking. Stir in yoghurt and serve with basmati rice.

### To cook by Sensor Cook:

Cover with plastic wrap. Select **Curries**, then press **Start**.

## MUSSAMAN BEEF CURRY

Serves: 4

### Ingredients:

500 g	round steak diced
1/3 cup	mussaman curry paste
400 g	potato diced
250 ml	coconut milk
250 ml	beef stock
1 tablespoon	brown sugar

### Method:

Place steak, curry paste and potato in a 3-litre casserole dish cook on P10 for 6 minutes. Add coconut milk, beef stock and brown sugar, stir, cook on P5 for 40 minutes. Stir once during cooking serve with jasmine rice.

### To cook by Sensor Cook:

Follow general directions. Select **Curries**, then press **Start**.

## General Guide to Curries for Sensor Cook

Serves	Weight of meat	Amount of liquid (coconut milk, stock)	Weight of hard vegetables
2	250 g	375 ml	200 g
4	500 g	500 ml	400 g
6	750 g	750 ml	600 g

---

## BEEF BOURGUIGNONNE

---

Serves: 4 to 6

### Ingredients:

750 g	diced chuck steak
4 rashers	bacon
6	pickling, onions
2 cloves	garlic, minced
¼ cup	red wine
400 ml	tomato puree
½ cup	beef stock
1 teaspoon	minced chilli
1 teaspoon	dried tarragon
250 g	button mushrooms, halved

### Method:

Place all ingredients except mushroom in a 3-litre casserole dish, stir until combined. Cover and cook on P7 for 14 to 16 minutes. Stir and cook on P4 for 28 to 30 minutes.

---

## CORNED BEEF

---

Serves: 4

### Ingredients:

1.5	corned silverside
1 tablespoon	brown sugar
1 tablespoon	white vinegar
1	onion, cut in half
4	cloves
6	peppercorns
1	bay leaf
5 cups	water

### Method:

Rinse corned silverside under cold running water to remove excess salt. Place corned silverside in 4-litre casserole dish. Add remaining ingredients. Cover and cook on P10 for 10 minutes. Turn meat, cover and cook on P3 for 1¼ to 1½ hours. Stand corned silverside in cooking liquid for 10 minutes before carving.

**Note:** Depending on the size and shape of the silverside, it may require a further 10 to 15 minutes on P3.

---

## FRENCH ONION BEEF CASSEROLE

---

Serves: 4

### Ingredients:

100 g	onion, chopped
1 teaspoon	minced garlic
200 g	diced potatoes
600 g	beef, diced
100 g	carrots, diced
⅓ cup	tomato paste
1½ cups	beef stock
100 g	whole button mushrooms
¼ cup	frozen peas

### Method:

Place onion and garlic in 3-litre casserole dish. Cook on P10 for 1 to 2 minutes. Add remaining ingredients, except mushrooms and peas. Stir until combined. Cover and cook on P10 for 8 minutes. Stir and cook on P4 for 28 to 30 minutes. Add mushrooms and frozen peas. Stir cook on P4 for 14 to 15 minutes.

---

## GOULASH

---

Serves: 4

### Ingredients:

1	onion, chopped
1	clove garlic, crushed
1 tablespoon	butter
2 tablespoons	tomato paste
1 teaspoon	paprika
500 g	lamb, diced
1	small capsicum, diced
1 cup	beef stock
2 tablespoons	flour
2 tablespoons	water
2 tablespoons	sour cream

### Method:

Place onion, garlic and butter in 3-litre casserole dish. Cook on P10 for 1 to 2 minutes. Add tomato paste and paprika. Cook on P10 for a further 2 minutes. Add lamb, capsicum and stock. Cover and cook on P6 for 25 to 30 minutes, stirring halfway through cooking. Mix flour with 2 tablespoons of water and stir into goulash mixture. Cook on P10 for 1 to 2 minutes. Stir in sour cream and serve with pasta and rice.

### HINT:

It is better to cook meat for a lesser time in a recipe and add extra time if needed. This will prevent over cooking.

**SPAGHETTI MEAT SAUCE**

Serves: 4 to 6

**Ingredients:**

500 g	minced beef
1	onion, chopped
1 clove	garlic, minced
425 g	can tomatoes
1 cup	tomato paste
2	beef stock cubes
1 teaspoon	dried mixed herbs
	pepper

**Method:**

Combine all ingredients in a 3-litre casserole dish. Cook on P10 for 7 minutes, stir. Cook on P7 for 14 to 16 minutes. Stir halfway through cooking. Serve with spaghetti.

**BEEF STROGANOFF**

Serves: 4

**Ingredients:**

1	onion, sliced
1 clove	garlic, minced
750 g	rump steak sliced thinly
2 tablespoons	tomato sauce
2 tablespoons	worcestershire sauce
1	beef stock cube
1 teaspoon	paprika
1/3 cup	sour cream
200 g	sliced mushrooms

**Method:**

Place all ingredients (except sour cream and mushrooms) in a 3-litre casserole dish. Stir until combined. Cover and cook on P7 for 7 to 9 minutes, stirring once during cooking. Add mushrooms. Stir and cook on P7 for 4 to 5 minutes. Stir through sour cream.

**CHINESE BEEF AND VEGETABLES**

Serves: 4 to 6

**Ingredients:**

500 g	rump steak sliced
1 teaspoon	chopped ginger
1 clove	garlic, chopped
1 tablespoon	soy sauce
1/4 cup	Hoisin sauce
1/4 cup	sweet chilli sauce
3 cups	sliced vegetables

**Method:**

Place steak, ginger and garlic in a 3-litre casserole dish. Cook on P10 for 1 minute. Add soy sauce, Hoisin sauce and chilli sauce to meat mixture. Cook on P10 for 4 to 5 minutes. Add the vegetables, cover and cook on P10 for 3 to 5 minutes, stirring halfway through cooking. Let stand for 5 minutes before serving.

**LAMB PILAU**

Serves: 4

**Ingredients:**

1 tablespoon	oil
1	large onion, sliced
600 g	lean lamb, diced
400 g	can tomato pieces
2 teaspoons	garam masala
1 teaspoon	dried thyme
1 cup	long grain rice
600ml	hot chicken stock
150g	natural yoghurt
	freshly ground black pepper

**Method:**

Place the oil and onion in a 3 litre dish. Cover and cook on P10 for 2 to 3 minutes. Add lamb, tomato pieces, garam masala, and thyme. Cover and cook on P7 for 10 minutes. Stir. Cook on P7 for a further 10 minutes. Add the rice and chicken stock and cook covered on P5 for a further 30 minutes or until the rice is tender. Stir in yoghurt, season with pepper and serve.

**SEASONED ROAST LAMB**

Serves: 4 to 6

**Ingredients:**

1.4 kg	leg of lamb
1 tablespoon	seeded mustard
1 tablespoon	rosemary

**Method:**

Place lamb fat side down on rack set in a 3-litre dish. Brush with mustard and rosemary. Cook on P6 for 30 to 35 minutes, turn halfway through cooking. Stand, covered, for 15 minutes before slicing.

**GINGERED PORK STIR FRY**

Serves: 4

**Ingredients:**

500 g	sliced lean pork
1/4 cup	teriyaki sauce
1 tablespoon	honey
2 teaspoons	minced ginger
2 teaspoons	cornflour
1	onion, sliced
300 g	sugar snap peas, trimmed
1	zucchini, sliced
1/2	red capsicum, sliced
2	green onions, sliced
1/2 cup	bean sprouts
1 tablespoon	toasted sesame seeds

**Method:**

Place pork, teriyaki sauce, honey, ginger and cornflour in a 2-litre dish. Cover and marinate in the refrigerator for 2 hours. Place onion in a 3 litre dish. Cook on P10 for 1 to 2 minutes. Add marinated pork and sauces and cook on P7 for 3 to 4 minutes. Add peas, zucchini, capsicum, green onions and bean sprouts. Cook on P10 for 3 to 4 minutes. Sprinkle with sesame seeds and serve with noodles.

## Cooking Fresh Vegetables by Micro power

Place vegetables in a casserole dish. Add 2 to 3 tablespoons of water per 500 g of vegetables. Add salt to water or add after cooking. Do not place salt directly on vegetables. Cover dish with glass lid or plastic wrap.

Cook on P10 according to time recommended in the chart. Halfway through cooking, stir, turn vegetables over or rearrange.

Vegetables that are to be cooked whole and unpeeled, need to be pierced to allow steam to escape. Place vegetables on a paper towel lined dinner plate. Allow to stand, covered, according to the time indicated in the charts.

## Cooking Fresh Vegetables by Micro power

Vegetables should be covered and cooked on P10 power for best results. Weights given are trimmed weights.

VEGETABLE	QUANTITY	COOKING PROCEDURE	APPROX. COOKING TIME (in minutes) on P10
Asparagus	250 g	Covered dish with $\frac{1}{4}$ cup water.	1 to 3
Beans (finely sliced)	250 g	Covered dish with $\frac{1}{4}$ cup water.	3 to 5
Beetroot	4 whole (1 kg)	Covered with 1 cup water in 4-litre dish. Stand after cooking - 5 mins.	14 to 18
Broccoli	250 g	Covered dish with $\frac{1}{4}$ cup water.	4 to 6
Brussels Sprouts	250 g	Covered dish with $\frac{1}{4}$ cup water.	4 to 6
Cabbage	500 g	Shredded, with $\frac{1}{4}$ cup water in covered dish.	5 to 7
Carrots	4 (sliced finely) 250 g	With $\frac{1}{4}$ cup water in covered dish.	5 to 6
Cauliflower	500 g	With $\frac{1}{4}$ cup water in covered dish.	6 to 8
Celery	6 stalks (400 g) cut in 1 cm pieces	With $\frac{1}{4}$ cup water in covered dish.	4 to 6
Corn	2 cobs (500 g) 4 cobs (1 kg)	Brush with melted butter and cook in covered dish.	4 to 6 10 to 12
Eggplant	1 (500 g)	Dice with $\frac{1}{4}$ cup water in covered dish.	4 to 6
Mushrooms	250 g (sliced)	Cook with 2 tablespoons butter in covered dish.	2 to 4
Onions	3 (200 g)	Cut in quarters with $\frac{1}{4}$ cup water in covered dish.	5 to 7
Peas	250 g	Shell peas and place with $\frac{1}{4}$ cup water in covered dish.	3 to 5
Potatoes-Mashed -Jacket	500 g 3 Med	Peeled and quartered with $\frac{1}{4}$ cup water. Covered. Cook uncovered on paper towel lined plate.	8 to 10 7 to 9
Pumpkin	500 g	Peeled and cut into uniform pieces with $\frac{1}{4}$ cup water in covered dish.	7 to 9
Spinach / Silver beet	250 g	Remove stem, cut leaves into small pieces. Cook with $\frac{1}{4}$ cup water in covered dish.	4 to 6
Sweet Potato	500 g	In serving size pieces with 2 tablespoons water in covered dish.	7 to 9
Turnips	500 g	Peeled and sliced finely with $\frac{1}{4}$ cup water in covered dish.	6 to 8
Tomatoes	2 (300 g)	Sliced and cooked covered.	2 to 4
Zucchini	500 g	Cut in 2 cm pieces in covered dish.	5 to 7

**COOKING FROZEN VEGETABLES BY MICRO POWER**

Remove vegetables from package and place in an appropriate sized container. Vegetables frozen in a pouch should be placed on a dish and the top pierced. Cook on P10 according to directions given in chart. Vegetables should be cooked covered with a lid or plastic wrap.

Halfway through cooking, stir, turn vegetables over or rearrange. Stir after cooking. Allow to stand for 2 to 3 minutes before serving.

**Cooking Frozen Vegetables by Micro power**

VEGETABLE	QUANTITY	COOKING PROCEDURE	APPROX. COOKING TIME (in minutes) on P10
Beans	250 g	Cook in covered 2-litre dish.	4 to 6
Broad Beans	250 g	Cook in covered 2-litre dish.	5 to 7
Broccoli (spears)	350 g	Cook in covered 2-litre dish.	5 to 7
Brussels Sprouts	250 g	Cook in covered 2-litre dish.	5 to 7
Carrots (baby)	250 g	Cook in covered 2-litre dish.	6 to 8
Cauliflower	500 g	Cook in covered 2-litre dish.	5 to 7
Corn (½ cob)	125 g	Cook in covered 2-litre dish.	3 to 4
Corn (cobs)	250 g	Cook in covered 2-litre dish.	5 to 7
Mixed Vegetables	250 g	Cook in covered 2-litre dish.	5 to 7
Peas	250 g	Cook in covered 2-litre dish.	4 to 6
Spinach	250 g	Cook in covered 2-litre dish.	4 to 6

**COOKING FROZEN VEGETABLES BY SENSOR****COOK****(125 g - 1.0 kg)**

- Suitable for all types of frozen vegetables.
- Place in a suitable size dish. Do not use plastic dishes.
- Best results are achieved if large quantities are placed in a single layer.
- Add 1 tablespoon to ¼ cup water to vegetables, if desired.

- Butter, herbs etc. may be added before heating, but do not add salt until serving.
- Cover dishes securely with plastic wrap.
- During the cooking time, the oven will 'beep' and prompt you to stir/rearrange vegetables.
- At the end of the cooking time, stir vegetables and let stand, covered, for 2 to 3 minutes.

To Operate:

Select **Froz. Veg.**, then press **Start**.

## COOKING VEGETABLES AND ROOT VEGETABLES BY SENSOR COOK

### Vegetables

#### (125 g - 500 g by Sensor Cook)

- Suitable for cooking all types of leaf, green and soft varieties of vegetables, including broccoli, squash cauliflower, cabbage, asparagus, beans, celery, zucchini, spinach, capsicum or a mixture of these.
- All vegetables should be trimmed or prepared and cut into evenly sized pieces.
- Add 1 tablespoon to  $\frac{1}{4}$  cup of water to vegetables if dehydrated or a softer cooked texture is desired.
- Place in a suitable size dish.
- Butter, herbs, etc., may be added before heating, but do not salt vegetables until serving.
- Cover dishes securely with plastic wrap or a fitted lid.
- At the completion of heating, stir larger quantities of vegetables. Let stand, covered, for 2 to 3 minutes.

#### To Operate by Sensor Cook:

Select **Vegetables**, then press **Start**.

### COOKING DRIED BEANS OR PEAS BY MICRO POWER

Place hot tap water in 4-litre dish. Bring hot water to the boil on P10 for 10 to 12 minutes. Add beans and 2 tablespoons oil to water. Cook according to directions in chart. Stir. Allow to stand, covered, for 15 to 20 minutes.

### Potatoes

#### (125 g - 1.0 kg by Sensor Cook)

- Suitable for cooking root vegetables such as potatoes, sweet potatoes, pumpkin, onions, swede, carrots, turnip and beetroot.
- All vegetables should be trimmed or prepared and cut into even sized pieces.
- Add 1 tablespoon to  $\frac{1}{4}$  cup of water to vegetables if dehydrated or a softer cooked texture is desired.
- Place into an appropriate size dish and cover securely with plastic wrap or a fitted lid.
- If desired, butter, herbs etc. may be added but do not add salt until after cooking.
- During the cooking time, the oven will 'beep' and prompt you to stir/rearrange the vegetables.
- At the completion of cooking, stir larger quantities of vegetables. Let stand, covered, for 2 to 3 minutes.

#### To Operate by Sensor Cook:

Select **Potatoes**, then press **Start**.

**Note:** Beans such as red kidney beans and lima beans should be soaked overnight before cooking. 250 g of dried beans equals about 3 cups cooked beans. Use in place of canned beans.

### Cooking Dried Beans and Peas using Micro power

ITEM	CONTAINER	AMOUNT OF HOT WATER	APPROX. TIME TO BOIL HOT WATER on P10 (in minutes) COVERED	TO COOK BEANS on P3 (in minutes) COVERED
Lentils (250 g)	4-litre dish	2 litres	10 to 12	15 to 20
Soup Mix (250 g)	4-litre dish	2 litres	10 to 12	20 to 25
Split Peas or Lentils (250 g)	4-litre dish	2 litres	10 to 12	25 to 30
Beans (250 g) Soaked overnight	4-litre dish	2 litres	10 to 12	25 to 30

**POTATO BAKE**

Serves: 4 to 6

**Ingredients:**

750 g	peeled and sliced potatoes
300 ml	cream
¼ cup	milk
3	green onions, sliced
2	bacon rashers, chopped
½ cup	grated cheese

**Method:**

Combine potatoes, cream and milk in 2-litre casserole dish. Cook on P10 for 15 to 18 minutes. Top with green onions, bacon and cheese. Cook on P10 for 5 minutes.

**VEGETABLE FRITTATA**

Serves: 4 to 6

**Ingredients:**

400 g	potatoes, thinly sliced
½	red capsicum, sliced into strips
½	green capsicum, sliced into strips
1	tomato, diced
2 tablespoons	fresh basil, chopped
4	eggs
⅓ cup	sour cream
½ teaspoon	cracked black pepper
½ cup	grated tasty cheese

**Method:**

Place potatoes in a 2-litre shallow dish. Cook on P10 for 5 to 7 minutes. Arrange capsicum in a circular pattern on top of potato sprinkle with tomato and basil. Beat together eggs and sour cream in a jug. Pour over vegetables. Cook on P6 for 3 to 5 minutes. Sprinkle with pepper and cheese and cook on P6 for 7 to 9 minutes.

**CREAMED SPINACH**

Serves: 4

**Ingredients:**

1	bunch spinach, roughly chopped
4	green onions, finely chopped
1	clove garlic, crushed
2 tablespoons	sour cream
	salt and pepper

**Method:**

Cook washed spinach leaves, green onions and garlic in a covered 3-litre casserole dish on P10 for 5 to 7 minutes.

**To cook by Sensor Cook:**

Prepare as above. Cover with plastic wrap. Select **Vegetables**, then **Start**. Drain well by squeezing between two dinner plates. Stir through sour cream. Season to taste. Cook on P10 for 1 to 2 minutes. Serve.

**ARDENNIS STYLE POTATOES**

Serves: 4

**Ingredients:**

4	medium sized potatoes
100 g	ham, finely diced
3 tablespoons	snipped chives
50 g	butter
½ cup	grated Cheddar cheese
	ground black pepper

**Method:**

Scrub potatoes, wash and pat dry with paper towel. Prick skins and place on a dinner plate. Cook on P10 for 6 to 8 minutes.

**To cook by Sensor Cook:**

Prepare as above. Cover with plastic wrap. Select **Potatoes**, then **Start**.

Allow to cool slightly. Cut tops off potatoes and scoop out pulp from centre, leaving 1 to 2 cm in shell. Mash pulp and combine with remaining ingredients. Spoon filling back into potato shells. Place potatoes in 2-litre casserole dish. Cook on P10 for 2 to 3 minutes.

**CAULIFLOWER AU GRATIN**

Serves: 4

**Ingredients:**

500 g	trimmed cauliflower and cut into pieces
2 tablespoons	water
2 tablespoons	butter
2 tablespoons	flour
1 cup	milk
¼ cup	grated tasty cheese

**Method:**

Place cauliflower and water in a shallow casserole dish. Cover and cook on P10 for 6 to 8 minutes.

**To cook by Sensor Cook:**

Prepare as above. Cover with plastic wrap. Select **Vegetables**, then **Start**. Stand, covered, while making sauce. Place butter in a 4-cup glass jug. Cook on P10 for 1 to 2 minutes. Stir in flour and cook on P10 for 1 minute. Add milk gradually. Stir well. Cook on P10 for 2 to 3 minutes, stirring halfway through cooking. Drain cauliflower and pour over sauce. Sprinkle with cheese. Cook on P7 for 1 to 2 minutes.

**Note:** Depending on size and arrangement of cauliflower pieces, timing will vary.

**HINT:**

**TO SKIN TOMATOES:** Cut a cross into the tomato skin. Place 1 cup of hot tap water in a 2 cup jug or bowl and heat on P10 for 1½ minutes or until boiling. Add 1 tomato and heat for a further 20 to 30 seconds. Remove and repeat procedure with remaining tomatoes. The skin will loosen and can be easily removed.



**THAI VEGETABLE CURRY**

Serves: 4

**Ingredients:**

1	onion, sliced
2 tablespoons	green curry paste
3 cups	sliced vegetables
440 g	chick peas, drained
1 cup	coconut milk
1 tablespoon	lemon juice
1 tablespoon	soy sauce
½ cup	chopped nuts

**Method:**

Place onion and curry paste in a 3-litre casserole dish. Cook on P10 for 2 minutes. Add vegetables, chick peas, coconut milk, lemon juice and soy sauce. Cook on P10 for 6 to 8 minutes. Sprinkle with chopped nuts. Serve with jasmine rice.

**HERBED VEGETABLES**

Serves: 4 to 6

**Ingredients:**

200 g	sliced snow peas
200 g	sliced carrots
200 g	sliced zucchini
2 tablespoons	chopped fresh parsley

**Method:**

Place snow peas, carrots and zucchini in a 2-litre casserole dish. Cover. Cook on P10 for 4 to 6 minutes, stirring once during cooking. Sprinkle with parsley. Serve.

**TOMATO VEGETABLE CASSEROLE**

Serves: 4 to 6

**Ingredients:**

200 g	mushrooms, sliced
1	eggplant, chopped
200 g	zucchini, sliced
1	capsicum, sliced
1	onion, sliced
400 g	can tomatoes
½ cup	tomato paste
1 tablespoon	chopped basil
1 clove	garlic, minced

**Method:**

Place mushrooms, eggplant, zucchini, capsicum and onion in a 3-litre casserole dish. Cover. Cook on P7 for 10 minutes. Add tomatoes, tomato purée, herbs and garlic. Re-cover and cook on P10 for 8 to 10 minutes.

**To cook by Sensor Cook:**

Prepare vegetables as above. Cover with plastic wrap. Select **Vegetables** then **Start**. Add remaining ingredients. Cover with plastic wrap. Cook on P10 for 8 to 10 minutes.

**HINT:**

It is better to slightly undercook vegetables as they will soften on standing. Allow to stand, covered, with plastic wrap or a lid.

**HINT:**

Wrap jacket potatoes in foil after cooking. They will retain their heat for about 15 to 20 minutes.

**SAVOURY BRUSSELS SPROUTS**

Serves: 4

**Ingredients:**

250 g	brussels sprouts
1 tablespoon	butter
150 g	bacon, finely chopped
1	onion, finely chopped
1 teaspoon	dill or basil
1 teaspoon	sugar

**Method:**

Wash and drain brussels sprouts. Cook in a covered 2-litre casserole dish on P10 for 4 to 5 minutes.

**To cook by Sensor Cook:**

Prepare as above. Cover with plastic wrap. Select **Vegetables**, then **Start**.

Drain and set aside. Place remaining ingredients in separate 1-litre casserole dish. Cook on P10 for 3 to 5 minutes. Add brussels sprouts and cook on P10 for 1 to 2 minutes. Serve.

**HONEY GLAZED CARROTS AND SUGAR SNAP PEAS**

Serves: 4 to 6

**Ingredients:**

350 g	carrots
150 g	sugar snap peas, trimmed
2 tablespoons	brown sugar
2 teaspoons	butter
2 tablespoons	honey
1 tablespoon	toasted sesame seeds

**Method:**

Peel and thinly slice carrots. Combine all ingredients in a 2-litre casserole dish. Cover and cook on P10 for 5 to 7 minutes, stirring halfway through cooking. Serve.

**To cook by Sensor Cook:**

Prepare as above. Cover with plastic wrap. Select **Vegetables**, then **Start**.

**PARMESAN ASPARAGUS**

Serves: 2 to 4

**Ingredients:**

1	bunch of asparagus spears
2 tablespoons	water
1 tablespoon	butter
1	clove garlic, crushed
1 tablespoon	grated Parmesan cheese

**Method:**

Place asparagus and water in a 2-litre casserole dish. Cover and cook on P10 for 1 to 2 minutes. Drain. Place butter and garlic in a small dish and cook on P10 for 1 minute. Add drained asparagus and mix lightly. Cook on P10 for a further 1 minute. Sprinkle Parmesan cheese over asparagus. Serve.

**Tip:**

When placing asparagus in dish, place half the tips one way and half the tips in the opposite direction for more even cooking.



## Cooking Legumes by Sensor Cook

- Suitable for cooking chickpeas, split peas dried beans and peas and brown rice.
- Cover legumes with cold water and soak overnight, drain.
- Place legumes and boiling water into an appropriate sized dish.( See table for quantities )

Amount of Legumes	Amount of Boiling Water	Dish Size
1 cup	3 cups	2 litre
2 cups	4 cups	3 litre
3 cups	6 cups	4 litre
4 cups	8 cups	4 litre

- For sensor cook, cover with plastic wrap. Select **Legumes**, then press **Start**.
- Anytime during cooking the oven will beep and prompt you to stir. Remove covering.
- At the end of cooking time, allow legumes to stand for 5 minutes if required.

## RED COCONUT DHAL

Serves: 4 to 6

### Ingredients:

1 cup	red lentils
1 teaspoon	turmeric
400 ml	coconut milk
250 ml	water
1 teaspoon	crushed red chilli
1 teaspoon	crushed garlic
lemon juice to taste	

### Method:

Place all ingredients in a 2 litre casserole dish. Stir and cook on P6 for 18 to 20 minutes, stirring twice during cooking.

### To cook by Sensor Cook:

Prepare as above; cover with plastic wrap, select **Legumes** then **Start**.

## HUMMUS

### Ingredients:

1 cup	chick peas, water for soaking
3 cups	boiling water
2 tablespoons	lemon juice
2 teaspoon	turmeric
¼ cup	tahini ( sesame paste )
4 cloves	garlic, minced
2 tablespoons	olive oil

### Method:

Place chickpeas and water into a 4-litre casserole dish and soak overnight. Drain.  
Place chickpeas and boiling water into a 3-litre casserole dish and cook on P6 for 25 to 30 minutes. Drain, process with remaining ingredients.

### To cook by Sensor Cook:

Prepare as above; cover with plastic wrap, select **Legumes** then **Start**.

## Chickpea Salad with Coriander

### Dressing

Serves: 4 to 6

### Ingredients:

1 cup	dried chickpeas, water for soaking
3 cups	boiling water
1	red capsicum, diced
1	lebanese cucumber, diced
250 g	cherry tomatoes, quartered
1	spanish onion, diced

### Coriander Dressing:

½ cup	lemon juice
2 teaspoons	sugar
½ cup	chopped fresh coriander
1 teaspoon	chopped red chilli

### Method:

Cover chickpeas with water and soak overnight. Drain. Place chickpeas and boiling water into a 3-litre dish and cook on P7 for 25 to 30 minutes.

### To cook by Sensor Cook:

Prepare as above, cover with plastic wrap, select **Legumes** then **Start**.

Drain and allow to cool.

Combine remaining salad ingredients in a large bowl and mix well.

### Dressing:

Combine all ingredients in a screw top jar, shake well. Pour over salad and toss well.

## Lentil Hot Pot

Serves: 4 to 6

### Ingredients:

900 g	new potatoes
2	onions, diced
2	carrots, diced
2	stalks celery, sliced
3	cloves garlic, crushed
1 teaspoon	curry powder
400 g	can diced tomatoes
1 cup	vegetable stock
2 tablespoon	tomato paste
¾ cup	red lentils, washed
½ cup	grated cheese
paprika	
1 tablespoon	chopped parsley

### Method:

Wash potatoes and place onto a paper towel lined plate. Cook on **Sensor Cook Potatoes** or P7 for 8 to 10 minutes. Set aside. Place onion, carrot, celery and garlic into a 3 litre dish. Cook on P7 for 7 to 8 minutes. Add curry powder and cook on P7 for a further 1 minute. Add tomatoes, stock, tomato paste and lentils. Cook on P7 for 20 to 24 minutes, stirring halfway through cooking. Slice potatoes thickly and layer over the top of lentil mixture. Sprinkle with grated cheese, paprika and parsley. Cook on P10 for 4 to 6 minutes.

## Cooking Rice by Micro power

Follow directions in chart for recommended dish size, amounts of water and cooking time. Add rice to water. Add salt and butter according to package directions. Cook on P10 for time recommended in

chart. Allow to stand, covered, before serving. For special rice, substitute beef or chicken stock for water. Add cooked onion, mushrooms or crumbled bacon before serving.

ITEM	CONTAINER	AMOUNT OF TAP WATER	APPROX. TIME TO COOK GRAIN on P10 UNCOVERED (in minutes)	STANDING TIME (in minutes)
RICE				
Quick Cook Brown (1 cup)	2-litre dish	1 $\frac{1}{3}$ cups	10	5
Brown (1 cup)	3-litre dish	3 cups	25 to 30	10
Long Grain (1 cup)	2-litre dish	2 cups	12 to 14	5
Short Grain (1 cup)	2-litre dish	2 cups	12 to 14	5

## Cooking Rice by Sensor Cook

- **Minimum weight 1 cup / Maximum weight 2.5 cups**
- Suitable for cooking short and long grain rice including specialty rices.
- It is not suitable for cooking brown rice or wild rice.
- Place rice with water at room temperature in a suitable dish. We recommend the following proportions of rice to cold tap water:

Rice	Water	Dish Size
1 cup	2 cups	3 litre
1 $\frac{1}{2}$ cups	3 cups	3 litre
2 cups	4 cups	4.5 litre
2 $\frac{1}{2}$ cups	5 cups	4.5 litre

It may be necessary to adjust the water to your personal preference.

- Using a large size dish will prevent the rice from boiling over.
- Do not cook rice in plastic dishes as incorrect cooking times may result.
- Cover dish securely with plastic wrap.
- During cooking, the oven will 'beep' and instruct you to stir and 'remove cover'. Remove the plastic wrap or lid and stir. There is no need to cover the rice again.
- At the completion of the cooking time, let stand 5 to 10 minutes.

**To Operate:** Select **Rice**, then press **Start**.

**PAELLA**

Serves: 6 to 8

**Ingredients:**

500 g	mussels
¼ cup	water
1	green capsicum, sliced
1	red capsicum, sliced
1	onion, sliced
1	clove garlic, crushed
2 tablespoons	butter
2 cups	long grain rice
400 g	can peeled tomatoes, chopped
2 cups	hot chicken stock
	pinch saffron powder
1½ cups	cooked diced chicken
200 g	peeled green prawns

**Method:**

Place mussels and water in a 3-litre dish. Cover and cook on P7 for 3 to 5 minutes. Set aside. Place capsicum, onion, garlic and butter into 4-litre dish and cook on P10 for 4 to 5 minutes. Add rice and stir well. Cook on P10 for 2 to 4 minutes. Stir in tomatoes, hot chicken stock and saffron. Cook on P10 for 16 to 18 minutes. Stir in chicken, prawns and mussels. Cook on P7 for 4 to 6 minutes. Stand for 10 minutes before serving.

**FRAGRANT COCONUT RICE**

Serves: 4 to 6

**Ingredients:**

1	onion, chopped
2 cups	long grain rice
500 ml	chicken stock
400 ml	coconut milk
1 teaspoon	turmeric

**Method:**

Place all ingredients in a 3-litre casserole dish. Stir. Cook on P10 for 15 to 18 minutes. Cover and let stand 10 minutes before serving.

**To cook by Sensor Cook:**

Prepare as above. Cover with plastic wrap.

Select **Rice**, then **Start**.

When oven beeps, remove plastic wrap, stir.

**SEASONED RICE**

Serves: 4 to 6

**Ingredients:**

1	onion, chopped
1 cup	long grain rice
1 teaspoon	thyme
1½ cups	chicken stock
¼ cup	toasted slivered almonds

**Method:**

Place onion, rice, thyme and chicken stock in a 3-litre casserole dish. Cook on P10 for 14 to 16 minutes. Stir, cover, and let stand for 10 minutes. Stir through slivered almonds and serve hot.

**To cook by Sensor Cook:**

Prepare as above. Cover with plastic wrap.

Select **Rice**, then **Start**.

When oven beeps, remove plastic wrap.

**FRIED RICE**

Serves: 4

**Ingredients:**

1 tablespoon	sesame oil
1	clove garlic, crushed
1 cm	piece of green ginger, finely chopped
1	small carrot, finely chopped
1	stick celery, sliced
½	green or red capsicum, cut in strips
2	eggs
4	green onions, chopped
	black pepper
1	small can prawns
1 tablespoon	soy sauce
6 cups	cooked rice

**Method:**

Place oil, garlic and ginger in a large shallow dish and cook on P10 for 30 to 40 seconds. Add carrot, celery and capsicum. Cook a further 2 minutes on P10. Break eggs into a small dish, add pepper to taste, mix well and cook on P7 for 1 to 1½ minutes. Slice into thin strips. Add eggs plus all remaining ingredients to vegetable mixture. Stir well and cook on P10 for 3 to 5 minutes to heat thoroughly. Serve.

**Notes:**

- 1 cup uncooked rice will yield 2 cups cooked rice.
- Cooked rice can be cooked using **Sensor Cook** functions.

**CHICKEN RISOTTO**

Serves: 4

**Ingredients:**

1	onion, sliced
2 cups	short grain rice
1 teaspoon	dried oregano
1 teaspoon	cracked black pepper
4 cups	chicken stock
¼	green capsicum, sliced
¼	red capsicum, sliced
200 g	mushrooms, sliced
½ cup	frozen peas
2	cooked chicken breast fillets, sliced
¼ cup	grated parmesan cheese

**Method:**

Place onion, rice, oregano, pepper and chicken stock into a 4-litre dish. Cook on P10 for 17 to 19 minutes. Add remaining ingredients, stir well and cook on P10 for 4 minutes. Serve.

**HINT:**

**TO REHEAT 2 CUPS OF COOKED RICE:**  
Add 1 to 2 tablespoons of water or a knob of butter and cook on P10 for 2 to 3 minutes.

## Cooking Risotto by Sensor Cook (S)

- Suitable for cooking many basic risotto recipes and variations.
- Onions and garlic should be pre-cooked with 1 tablespoon of oil before adding rice and stock.
- Follow general directions in chart below for quantities of rice and amounts of stock.
- Always use arborio rice or shortgrain rice.
- Chicken, vegetable, beef or fish stock may be used.
- Stock should be boiling when added to rice otherwise cooking times may be incorrect.
- Cover dish securely with plastic wrap at stage 1.
- During the cooking time the oven will beep and instruct you to add liquid/stir. Remove plastic wrap completely from dish. Add remaining stock. There is no need to re-cover for stage 2.
- At the end of stage 2 add grated parmesan cheese, stir through and cook for 2 to 4 minutes on P10.
- Standing time may be required at the end to allow risotto to finish cooking.

### To Operate:

Select **Risotto**, then press **Start**.

## BASIC RISOTTO RECIPE

Serves 4

### Ingredients:

1 tablespoon	olive oil
1	onion, diced
1	clove garlic, crushed
1½ cups	Arborio rice
4 cups	boiling stock
¼ cup	grated Parmesan cheese.

### Method

#### Pre-Cook:

Place oil, onion and garlic in a 3-litre ceramic dish. Cook on P10 for 1 to 2 minutes or until softened.

#### Stage 1:

Add rice and 2 cups of boiling stock to dish. Cover dish securely with plastic wrap. Select **RISOTTO**, then Press **START**.

#### Stage 2:

When oven beeps, remove plastic and stir in remaining stock.

**Note:** other ingredients may be added at this stage. eg. vegetables, cooked meats etc.

Return to oven and press start.

#### Stage 3:

At the end of cooking time, stir in grated Parmesan cheese and cook on for 2 to 4 minutes or until melted.

## General Quantities For Cooking Risotto

	Pre cook	Stage 1		Stage 2	Stage 3
	P 10 for 1 to 2 min. (all quantities)	Rice	Boiling Stock	Boiling Stock	P 10 for 2 to 4 min.
2 serves	½ onion 1 clove garlic 1 tabsp. Oil	¾ cup	250ml	250ml	2 tablespoons parmesan
4 serves	1 onion 2 cloves garlic 2 tabsp. Oil	1½ cups	500ml	500ml	¼ cup parmesan
6 serves	2 onions 3 cloves garlic 3 tabsp. Oil	2¼ cups	750ml	750ml	⅓ cup parmesan

## Cooking Pasta by Micro power

Follow directions in chart for recommended dish size, amount of water and cooking time. Boil water, with 1 teaspoon salt and 1 tablespoon oil. Add pasta and cook for time recommended in chart. Cook on

P10. Test pasta for desired cooking before adding more time. Slightly undercook pasta that will be heated again in casserole. Stir and let stand, uncovered, 5 minutes.

ITEM	CONTAINER	AMOUNT OF WATER	APPROX. TIME TO COOK PASTA on P10 UNCOVERED (in minutes)	STANDING TIME (in minutes)
Dried Fettuccine (250 g)	4-litre dish	6 cups	10 to 12	5
Elbow Macaroni, shells, etc. (250 g)	3-litre dish	4 cups	12 to 14	5
Fresh Spaghetti, Fettuccine (375 g)	4-litre dish	6 cups	6 to 8	5
Dried Spaghetti (250 g)	4-litre dish	4 cups	12 to 14	5
Fresh Tortellini, Ravioli (250 g)	4-litre dish	4 cups	7 to 9	5
Fresh Gnocchi (375g)	4-litre dish	6 cups	6 to 8	5

### Cooking Fresh and Dried pasta by Sensor Cook

#### Fresh Pasta (125 g - 625 g)

- Suitable for cooking fresh pasta such as fettuccine, tagliatelle, tortellini, ravioli and agnolotti. (Gnocchi should be cooked by manual MICRO POWER.)
- Place pasta in an appropriate size dish with boiling water. Use the above chart as a guide:
- Cover dish with plastic wrap.

**To Operate:** Select **Fresh Pasta**, then press **Start**.

#### Dried Pasta (125 g - 500 g)

- Suitable for cooking dried pasta such as spaghetti, fettuccine, macaroni, penne, spiral and various pasta shapes.
- Place pasta in an appropriate size dish with boiling water. Use the following as a guide:

Pasta	Boiling Water	Dish Size
150g	4 cups	3 litre
250g	5 cups	3 litre
350g	6 cups	4 litre
500g	8 cups	4 litre
625g	8 cups	5 litre

- Add 1 tablespoon of oil, if desired, before cooking to prevent pasta from sticking together.
- Cover dish with plastic wrap.
- Halfway through the cooking time, the oven will 'beep' and instruct you to 'Stir/Remove Cover'. Remove plastic wrap or lid and stir.
- At the end of the cooking time, cover and let stand for 5 to 10 minutes, if required, before draining.

**To Operate:** Select **Dried Pasta**, then press **Start**.

---

## PENNE PUTTANESCA

---

Serves: 4

### Ingredients:

500 g	Penne Pasta
2 litres	boiling water
1 tablespoon	olive oil
3	cloves garlic, crushed
1 teaspoon	dried chilli flakes
1 kg (approx 5)	tomatoes, roughly chopped
200 g	kalamata olives, pitted
8	anchovy fillets, drained and chopped
1/3 cup	capers, drained and rinsed
1/3 cup	flat leaf parsley, chopped
2 tablespoons	finely shredded basil leaves

### Method:

Place pasta and boiling water into a 4-litre dish. Stir and cook on P10 for 12 to 14 minutes or until tender. Drain and set aside. Place oil and garlic into a 2 litre dish and cook on P10 for 1 minutes. Stir in chilli and tomatoes. Cover and cook on P10 for 5 minutes, stir halfway through cooking. Add remaining ingredients and cook on P10 for a further 10 minutes or until tomatoes break down and sauce has thickened. Stir sauce into pasta. Cover and cook on P10 for 2 to 3 minutes to heat through. Season and serve topped with extra basil leaves or parsley.

---

## CREAMY SUN-DRIED TOMATO PENNE

---

Serves: 4

### Ingredients:

250 g	penne
6 cups	boiling water
1/2 cup	sun-dried tomatoes in oil, drained
1 cup	basil leaves
1/4 cup	toasted pinenuts
1/3 cup	grated parmesan cheese
300 ml	cream
1/2 cup	sliced ham
1/4 cup	grated parmesan cheese, extra

### Method:

Place pasta and water in a 4-litre casserole dish. Cook on P10 for 14 to 16 minutes, or cook by **Sensor Cook**. While pasta is cooking, prepare sauce. Place all ingredients except ham and extra parmesan cheese into a food processor. Process until smooth. Drain pasta and add sauce. Serve topped with ham and extra parmesan cheese.

### To cook by Sensor Cook:

Prepare as above. Cover with plastic wrap.

Select **Dried Pasta**, then **Start**.

### Tip:

To toast 1/4 cup pinenuts place into a small bowl. Cook on P10 for 3 to 4 minutes, stirring every minute.

---

## SPAGHETTI WITH CHILLI TOMATO SAUCE

---

Serves: 4

### Ingredients:

250 g	spaghetti
4 cups	boiling water
1 tablespoon	olive oil
1	onion, finely chopped
2	cloves garlic, crushed
425 g	can crushed tomatoes
2 teaspoons	crushed chillies
2 tablespoons	fresh chopped basil
1 teaspoon	pepper

### Method:

Place spaghetti and water in a 3-litre casserole dish. Cook on P10 for 12 to 14 minutes, or cook by **Sensor Cook**.

Stand, covered, for 2 minutes. Drain. Place oil, onion and garlic in a 4-cup jug. Cook on P10 for 1 to 2 minutes. Add tomatoes, chillies, basil and pepper. Stir until combined. Cover and cook on P7 for 10 to 15 minutes, stirring halfway through cooking. Serve with spaghetti.

### To cook by Sensor Cook:

Prepare as above. Cover with plastic wrap.

Select **Dried Pasta**, then **Start**.

---

## CREAMY BACON SAUCE

---

Makes: Approximately 300 ml

### Ingredients:

1	onion, chopped
3	bacon rashers, chopped
1 teaspoon	minced garlic
300 ml	cream
1/4 cup	Parmesan cheese
	pepper
2 tablespoons	chopped fresh parsley

### Method:

Place onion, bacon and garlic in a 2-litre casserole dish. Cook on P10 for 4 to 5 minutes. Add cream, Parmesan cheese, pepper, parsley and stock. Mix well. Cook on P10 for 3 to 4 minutes. Serve with cooked Fettuccine.

---

## MACARONI AND CHEESE

---

Serves: 4 to 6

### Ingredients:

40g	butter
1	onion, finely chopped
2 tablespoons	flour
2 cups	milk
1 cup	grated tasty cheese
6 cups	cooked macaroni, drained well
1/2 cup	extra grated tasty cheese
	paprika

### Method:

Place butter and onion in a 2-litre casserole dish and cook on P10 for 3 to 5 minutes. Add flour, mix well and cook on P10 for 1 minute. Blend in milk and cook on P10 for 4 to 5 minutes, stirring halfway through cooking. Add cheese to sauce and season. Place macaroni and sauce in a 3-litre casserole dish. Mix well.

Top with extra cheese and sprinkle with paprika. Cook on P10 for 6 to 8 minutes.

**Note:** Macaroni can be cooked using Sensor Cook and Auto Cook functions.

## Cooking Dried Noodles by Micro power

Follow directions in chart recommended dish size, amount of water and cooking time. Add 1 tablespoon of oil to water to prevent noodles from sticking together. Add noodles and cook for time recommended in chart. Cook noodles on P10. Test

noodles for desired cooking before adding extra time. Slightly undercook noodles that will be cooked again in a stir-fry or recipe. Always drain noodles immediately after cooking or they may overcook on standing.

ITEM	CONTAINER	AMOUNT OF BOILING WATER	APPROX. TIME TO COOK NOODLES on P10 UNCOVERED (in minutes)	INSTRUCTION
2 minutes noodles (85 g)	1-litre	500 ml	2 to 3	drain immediately
Long Life Asian Noodles (250 g)	3-litre	1 litre	5 to 6	drain immediately
Rice Vermicelli (125 g)	2-litre	1 litre	3 to 4	drain immediately

## Cooking Fresh Noodles by Sensor Cook (150 g - 800 g)

- Suitable for cooking fresh noodles such as Hokkien, Singapore, Udon, Soba, Rice noodles.
- Place noodles and boiling water as recommended in chart below in a suitable size dish.
- Cover securely with plastic wrap.
- The oven will beep during the cooking time and instruct you to "stir/remove cover". There is no need to re-cover noodles.
- At the end of cooking time, drain and use as required.

Noodles	Boiling Water	Dish Size
200g	¼ cup	1.5-litre
350g	½ cup	2-litre
500g	½ cup	2.5-litre
800g	½ cup	2.5-litre

**To Operate by Sensor Cook:**  
Select **Noodles**, then press **Start**.

## TERIYAKI TOFU VEGETABLE NOODLES

Serves: 4

### Ingredients:

1 tablespoon	sesame oil
350 g	firm tofu, diced
1	onion, cut into petals
300 g	stir fry vegetables
1 tablespoon	hoisin sauce
1 tablespoon	teriyaki sauce
85 g	2 minute noodles
2 cups	boiling water

### Method:

Place oil, tofu and onion in a 3-litre dish and cook on P10 for 2 to 3 minutes. Add vegetables and sauces and cook on P10 for 3 to 4 minutes, stirring once during cooking. Place noodles and water in a 2-litre bowl and cook on P10 for 2 minutes. Stir and drain. Toss noodles through tofu and vegetables and serve.

## SZECHUAN SALAD NOODLES

### Ingredients:

350 g	fresh Hokkien noodles
½ cup	boiling water
250 g	cooked chicken, shredded
½ cup	roasted cashew nuts

### Dressing:

4	green onions, finely sliced
2 tablespoons	chopped coriander
2	cloves garlic, minced
2 tablespoons	smooth peanut butter
2 tablespoons	sweet chilli sauce
1 tablespoon	soy sauce
1 tablespoon	sweet sherry
2 teaspoons	sesame oil
2 tablespoons	olive oil
2 tablespoons	chicken stock
10	toasted szechuan peppercorns, ground

### Method:

Place noodles in a bowl with the boiling water. Cook on P7 for 1 to 2 minutes. Drain and rinse under cold water. Drain well. Combine all dressing ingredients and whisk well. Combine noodles, chicken and cashew nuts and pour over dressing. Toss well to combine. Serve immediately.

### To cook Noodles by Sensor Cook:

Prepare as above. Cover with plastic wrap. Select **Noodles**, then **Start**.



Cakes, Desserts and slices can successfully be cooked in the microwave oven if a few simple rules are followed see individual recipes for instructions.

---

### Cooking Cakes by Micro power

---

- The texture of cakes cooked in the microwave oven is not the same as cakes cooked in a conventional oven, but it is a convenient way of cooking cakes.
- Do not use metal cake tins, plastic dishes and pyrex, give the best results when cooking cakes. Grease the dish and line with paper towel or bake paper to absorb excess moisture.
- Round or oval shaped dishes produce the most even cooking results. Square cakes may need the corners shielded with foil to prevent overcooking.
- Choose light coloured cakes that can be iced or substitute brown sugar for white sugar and sprinkle the top of cake with spices to give a darker appearance.
- Do not fill cake pans more than half full. Microwaved cakes rise substantially more than conventionally cooked cakes.
- Cakes need to be well mixed but do not over beat. Creaming with an electric mixer or food processor is not necessary. Use a fork to mix as the microwave aerates the mixture as it cooks.
- Do not cover cakes as the top will steam.
- Cakes should be removed from the oven just before they look cooked as the cooking process will finish during standing time.
- Chocolate cakes cook slightly faster than plain cakes.
- Cakes containing a large amount of whisked egg white will not cook successfully in the microwave oven.

---

### SULTANA CAKE

---

Serves: 4 to 6

#### Ingredients:

100 g	butter
1 cup	sultanas
1 cup	brown sugar
1 cup	milk
1	egg, beaten
2 cups	self-raising flour

#### Method:

Place butter, sultanas, brown sugar and milk in heat resistant mixing bowl. Cook on P10 for 3 to 4 minutes. Stir halfway through cooking. Allow to cool. Add egg and flour. Pour batter into base of lined 20 cm round dish. Cook on P6 for 9 to 11 minutes. Let cool, loosely covered, with plastic wrap on wire rack.

---

### PACKET CAKE

---

#### Ingredients:

1 packet cake mix (340 g)  
Ingredients as recommended by manufacturer.

#### Method:

Mix cake and other ingredients with a metal spoon. DO NOT OVERBEAT. Pour into 20 cm round dish that has been lightly greased and lined with paper. Cook on P8 for 5 to 7 minutes. Stand and allow to cool before removing.

#### Variations:

- 1 tablespoon jam added to batter before cooking.
- Add 1 cup sour cream to batter and halve water suggested by manufacturer.
- Half a cup chopped nuts,  $\frac{1}{4}$  cup brown sugar and 1 teaspoon cinnamon. Mix and place on base of cake dish before cooking cake.
- Melt two tablespoons honey and 30 g butter in glass jug on P10 for 30 to 60 seconds. Pour over just baked buttercake. Sprinkle with cinnamon. Serve warm with cream or custard as a dessert or serve cold with cream as tea cake.
- A quarter cup of toasted muesli mixed with 1 tablespoon marmalade and placed in the base of the dish.

**Tip:** Packet cakes are best mixed by hand as the microwave will do the aerating.

---

### QUICK MIX CHOCOLATE CAKE

---

Serves: 4 to 6

#### Ingredients:

1 cup	self-raising flour
1 cup	caster sugar
2 tablespoons	cocoa
3 tablespoons	butter, softened
2	eggs
$\frac{1}{3}$ cup	milk

#### Method:

Sift all dry ingredients into a bowl. Add butter, eggs and milk. Beat with wire whisk for 1 to 2 minutes. Grease 2-litre plastic ring mould and line with paper towel. Pour mixture into mould and cook on P7 for 5 to 7 minutes. Stand, covered, for 5 minutes before turning out. Cool on wire rack.

**Tip:** To soften butter cook on P5 for 10 to 20 seconds.

**CHOCOLATE SELF SAUCING PUDDING**

Serves: 4

**Ingredients:**

1 cup	self raising flour
1 tablespoon	cocoa powder
1/3 cup	caster sugar
1/2 cup	milk
1 teaspoon	vanilla essence
100 g	chocolate
30 g	butter
3/4 cup	brown sugar
2 tablespoons	cocoa, extra
3/4 cup	water

**Method:**

Sift flour and cocoa into a 2-litre bowl. Add sugar, milk and vanilla essence. Mix well. Place chocolate and butter in a 2-cup pyrex jug and cook on P7 for 1 to 1 1/2 minutes. Stir and add to mixture. Mix well. Spread mixture into base of 2-litre casserole dish. Combine brown sugar, cocoa and water in 2-cup jug. Pour evenly over pudding. Cook on P10 for 4 to 6 minutes.

**HINT:****TO MELT CHOCOLATE:**

Place 100 g broken chocolate in a 4-cup glass jug and heat on P5 for 1 to 2 minutes. As chocolate holds its shape after heating, stir and stand before adding extra cooking time.

**APPLE CRUMBLE**

Serves: 4

**Ingredients:**

780 g	can pie apples
1/2 cup	rolled oats
1/4 cup	plain flour
1/2 cup	desiccated coconut
1/2 cup	brown sugar
1 teaspoon	cinnamon
60 g	butter

**Method:**

Place apples in the base of a 1-litre casserole dish. Place remaining ingredients (except butter) in mixing bowl. Melt butter in a 2-cup jug on P10 for 40 to 60 seconds. Combine melted butter with dry ingredients and mix well. Spread evenly over apples. Cook on P10 for 5 to 8 minutes.

**PEACH AND MUESLI CRUMBLE**

Serves: 6 to 8

**Ingredients:**

80 g	butter
1/2 cup	flour
1/4 cup	caster sugar
1 1/2 cups	toasted muesli
1/2 cup	shredded coconut
1/2 teaspoon	cinnamon
810 g	peach slices, drained

**Method:**

Place butter in a 2-litre jug. Cook on P7 for 1 minute. Add flour, sugar, muesli, coconut and cinnamon, stir until combined. Place peaches into a 1-litre casserole dish. Place crumble mixture on top of peaches and cook on P10 for 10 to 12 minutes. Serve with cream or ice cream.

**APRICOT COBBLER**

Serves: 4 to 6

**Ingredients:**

800 g	apricot halves
1 (340 g)	packet butter cake mix
1/2 cup	toasted coconut
70 g	butter, melted

**Method:**

Arrange apricots on the base of a 20 cm casserole dish. Combine cake mix, toasted coconut and butter. Sprinkle cake mixture over apricots. Cook on P10 for 6 to 8 minutes.

## Cooking Fruit by Micro Power

<b>FRUIT - Peel, slice, chop into even sized pieces. Place in shallow heatproof dish on turntable.</b>				
Apples - poached	500 g	P10	8	Add 300 ml of water. Only half fill dish. Cover.
Apples - stewed	500 g	P10	6	Only half fill dish. Cover.
Peaches - poached	500 g	P10	4 - 5	Add 300 ml of water. Only half fill dish. Cover.
Pears - poached	500 g	P10	6 - 7	Add 300 ml of water. Only half fill dish. Cover.
Plums - poached	500 g	P10	8	Add 300 ml of water. Only half fill dish. Cover.
Plums - stewed	500 g	P10	8 - 10	Add 30 ml (2 tbsp) of water. Only half fill dish. Cover.
Rhubarb - stewed	500 g	P10	5	Only half fill dish. Cover.

### **SWEET BERRY SAUCE**

Makes: Approximately 2 cups

#### **Ingredients:**

½ cup	caster sugar
½ cup	water
500 g	berries, halved if large
2 tablespoons	water
1 tablespoon	cornflour

#### **Method:**

Combine sugar and water in a 3-litre bowl. Cook on P10 for 2 to 3 minutes. Add berries. Cook on P10 for 3 to 4 minutes. Blend water and cornflour. Mix into berry sauce. Cook on P10 for 2 minutes. Serve hot or cold with ice cream.

### **CINNAMON POACHED PEARS**

Serves: 4

#### **Ingredients:**

½ cup	water
½ cup	caster sugar
½ teaspoon	cinnamon
4	pears, peeled and sliced

#### **Method:**

Combine water, caster sugar and cinnamon in a 1-litre jug. Cook on P10 for 2 minutes. Place the pears in a 2-litre dish. Pour over syrup and cover. Cook on P10 for 6 to 8 minutes.

#### **Tip:**

To soften butter cook on P5 for 10 to 20 seconds.

### **FIGS IN RIESLING AND HONEY**

Serves 4

#### **Ingredients:**

8	firm figs
1½ cups	Riesling wine
80 ml	honey
1 teaspoon	lemon juice
1 teaspoon	grated lemon rind
2 tablespoons	chopped pistachio nuts

#### **Method:**

Wash and stem the figs place into a 2 litre dish  
Combine Riesling, and honey and pour over figs.  
Cook on P7 for 6 to 8 minutes  
Remove figs from syrup, set aside  
Add lemon juice and rind to syrup and cook on P10 for 3 to 4 minutes or until slightly reduced.  
Pour syrup over figs and allow to cool. Serve with ice cream or cream and sprinkle with pistachio nuts.

**FRUIT MINCE**

Serves: 4

**Ingredients:**

250 g	mixed dried fruit
400 g	can crushed pineapple and juice
1	cooking apple peeled, cored and grated
1 cup	brown sugar
1 tablespoon	brandy
1 teaspoon	nutmeg
1 teaspoon	cinnamon
1 tablespoon	cornflour
¼ cup	water

**Method:**

Combine all ingredients (except cornflour and water) in a 2-litre casserole dish. Cook on P7 for 3 to 5 minutes. Blend cornflour with water and stir into fruit mixture. Cook on P10 for 3 to 5 minutes. Stir. Cool. Bottle and seal or use immediately.

**INDIVIDUAL CHRISTMAS PUDDING**

Makes: 8

**Ingredients:**

100 g	sultanas
150 g	raisins
50 g	craisins
100 g	dates, chopped
100 g	dried figs, chopped
50 g	glace ginger, chopped
½ cup	brandy
125 g	butter
¾ cup	firmly packed brown sugar
2	eggs
½ teaspoon	cinnamon
½ teaspoon	mixed spice
½ teaspoon	nutmeg
½ cup	plain flour
½ cup	pie apple
¾ cup	fresh breadcrumbs
1 tablespoon	golden syrup
1 tablespoon	parisienne essence

**Method:**

Place all dried fruits and brandy into a 2-litre bowl. Mix and cook uncovered on P3 for 10 minutes. Stir halfway through cooking. Cool. Beat butter and sugar in a large bowl with an electric mixer until light and fluffy. Add eggs, one at a time, beating between each addition. Stir in cooled fruits, then remaining ingredients. Grease 4 x 200 ml microwave safe cups. Place half a cup of mixture into each cup, pushing mixture in firmly. Smooth over the top of puddings with the back of a spoon. Place cups evenly around the edge of the microwave turntable and cook uncovered on P3 for 20 minutes. Stand for 5 minutes before turning out. Repeat with remaining mixture. Serve with cream or custard.

**MINCE PIES • CAUTION**

Take care not to overheat mince pies, otherwise burning can occur due to the high fat and sugar content of the filling. Check the temperature of the filling before consuming to avoid burning your mouth. REMEMBER even if the pastry is cold to the touch, the filling will be piping hot and will warm the pastry through.

**CHOCOLATE PÂTÉ**

Makes 24 x 8 cm loaf tin

**Ingredients:**

300 g	dark chocolate
400 g	can condensed milk
1 cup	brazil nuts
½ cup	hazelnuts
⅓ cup	glace cherries
½ cup	sultanas

**Method:**

Break chocolate into pieces and place with condensed milk in a 2-litre dish. Cook on P7 for 3 to 5 minutes, stirring twice during cooking. Fold through nuts and fruits. Line a 24 x 8 cm loaf tin with foil and pour in the mixture. Chill for several hours or until set. Turn out and serve thinly sliced.

**STIRRED CUSTARD**

Makes: Approximately 400 ml

**Ingredients:**

3 tablespoons	sugar
2 tablespoons	custard powder
1½ cups	milk
2	egg yolks, lightly beaten
1 teaspoon	vanilla essence

**Method:**

Combine sugar and custard powder in 4-cup jug. Gradually stir in milk until smooth. Cook on P6 for 4 to 5 minutes, stirring halfway through cooking. Add egg yolks and mix well. Cook on P6 for further 30 to 60 seconds. Add vanilla, stir well and serve.

**BRANDY SAUCE**

Makes: 1½ cups

**Ingredients:**

2 tablespoons	butter
2 tablespoons	cornflour
3 tablespoons	sugar
2 tablespoons	golden syrup
1 cup	milk
¼ cup	brandy

**Method:**

In a 1-litre pyrex jug melt butter on P10 for 20 to 30 seconds. Blend in cornflour, sugar and golden syrup and cook on P10 for 50 to 60 seconds. Add milk gradually and cook on P6 for 3 to 4 minutes. Stirring halfway through cooking. Stir in brandy. Serve hot with fruit or Christmas pudding.

**CHOCOLATE BROWNIES**

Makes: 1 x 20 cm square slice pan

**Ingredients:**

125 g	butter
200 g	chocolate
1 cup	caster sugar
1 teaspoon	vanilla essence
3	eggs
1 cup	plain flour

**Method:**

Grease and line 20 cm square pyrex dish. Melt butter and chocolate in 2-litre dish on P7 for 2 minutes. Stir in sugar, vanilla essence, eggs and flour. Spread into prepared dish. Cook on P7 for 5 to 6 minutes. Refrigerate until cold. Cut into squares.

**RHUBARB, APPLE & GINGER COMPOTE**

Serves: 4

**Ingredients:**

300 g	rhubarb, trimmed cut to 3 cm lengths
2	apples, peeled, cored and diced
30 g	crystallised ginger, thinly sliced
½ cup	caster sugar
1	orange, grated rind and juice

**Method:**

Place all ingredients into a 2-litre microwave safe dish. Stir to dissolve sugar. Cook on P10 for 8 to 10 minutes or until fruit is softened.

**MOCHA FUDGE**

Makes: 64 x 2.5 cm square pieces

**Ingredients:**

395 g	can sweetened condensed milk
300 g	dark chocolate melts
1 teaspoon	vanilla extract
1 teaspoon	instant coffee powder
64	chocolate coated coffee beans

**Method:**

Grease a square (20 cm) cake pan, set aside. Place condensed milk and chocolate in a 1.5-litre microwave safe and heatproof bowl. Cook on P7 for 2 minutes. Stir in vanilla and coffee. Mix until well combined. Cook on P5 for 2 minutes. Stir and pour into prepared pan. Arrange coffee beans evenly over the fudge. Chill for 2 hours or until set. Cut into 2.5 cm squares to serve.

**Tip:**

Chocolate coated coffee beans are available from specialty coffee shops.

**Preserving Precautions**

Do not use your oven for home canning or the heating of any closed jar. Pressure will build up and the jar may explode. In addition, the microwave oven cannot maintain the food at the correct canning temperature. Improperly canned food may spoil and be dangerous to consume.

**Jars and Bottles**

Jars and bottles can be used to warm food to serving temperature. If the lid is removed first. Cooking should not be done in these containers since most are not heat resistant and during extended heating times, heat from food would cause cracking or breaking.

**Thermometers** are available for use in microwave ovens. DO NOT USE CONVENTIONAL MERCURY TYPE CANDY OR MEAT THERMOMETERS in food while cooking in the microwave oven.

Alternatively, a conventional meat thermometer may be used after the food is removed from the oven.

**Sterilizing Jars**

Jam jars can be sterilized by microwave ready for your jams. Half fill with water and heat them on HIGH power until water boils (approx.3 mins, for 2 jars). Empty and drain upside down on kitchen paper. The jars should be warm when filled with jam.

**TOMATO CHUTNEY**

Makes: 3 cups (750 ml)

**Ingredients:**

250 g	onion, finely chopped
1.5 kg	ripe tomato, skins removed and chopped
1 teaspoon	salt
1 teaspoon	paprika
	pinch cayenne pepper
150 ml	malt vinegar
175 g	sugar

**Method:**

Place onions in a 3-litre dish. Cover. Cook on P10 for 4 to 5 minutes. Add tomatoes. Cover. Cook on P10 for 5 to 6 minutes. Add salt, spices and vinegar. Stir well. Cook on P10 for 10 minutes, stirring halfway through. Add sugar, stir well and cook on P7 for 35 to 40 minutes. Stirring occasionally. Pour into sterilised jars and seal.

**LEMON BUTTER**

Makes: 1 cup (250 ml)

**Ingredients:**

½ cup	lemon juice
1 tablespoon	lemon rind
⅓ cup	sugar
3	egg yolks
1 tablespoon	butter
1 tablespoon	cornflour

**Method:**

Blend all ingredients in a 4-cup glass jug. Cook on P6 for 4 to 5 minutes, stirring every minute. Pour into hot sterilised jars and seal immediately.

**BASIC WHITE SAUCE**

Makes: 1 cup

**Ingredients:**

2 tablespoons butter  
 2 tablespoons flour  
 salt and white pepper  
 1¼ cups milk

**Method:**

Place butter in a 4-cup jug. Cook on P10 for 30 to 40 seconds. Stir in flour, salt and pepper. Gradually add milk, stirring until smooth. Cook on P10 for 2 minutes, stirring every minute.

**Tip:** For cheese sauce, stir in ½ cup grated cheese once sauce has thickened.

**GRAVY**

Makes: 2 cups

**Ingredients:**

2 tablespoons dripping or pan juice  
 1 small onion, finely chopped  
 2 tablespoons flour  
 1 tablespoon tomato paste  
 1½ cups beef stock  
 salt and pepper

**Method:**

Place dripping or pan juices and onion in a 2-cup jug. Cook on P10 for 2 minutes. Add flour, tomato paste and half of the beef stock. Stir well. Cook on P10 for 2 minutes. Add remaining stock. Stir well and cook on P10 for a further 2 minutes. Season with salt and pepper. Serve with the meat of your choice.

**CHEESE SAUCE**

Makes: 1½ cups

**Ingredients:**

40 g butter  
 2 tablespoons flour  
 1½ cups milk  
 ½ cup grated cheese

**Method:**

Melt butter in 1-litre jug on P10 for 30 seconds. Add flour and mix well. Gradually stir in milk. Cook on P10 for 3 to 4 minutes. Stirring halfway through cooking. Add cheese and cook on P10 for a further 1 to 1½ minute. Stir and serve with vegetables of your choice.

**HINT:****COOKING SAUCES:**

When making some sauces in the microwave oven, less liquid may be needed as less evaporation occurs with a shorter cooking time.

**LEMON LIME CORDIAL**

Makes: approximately 1.5 litres of undiluted cordial

**Ingredients:**

10 large lemons  
 6 limes  
 4 cups sugar  
 2 cups water  
 2 teaspoons citric acid

**Method:**

Squeeze juice from lemons and limes. Place in a 3 to 4-litre dish with the remaining ingredients. Cook on P10 for 8 to 10 minutes. Stir 2 to 3 minutes during this cooking time to dissolve sugar. Cook on P10 for 25 to 30 minutes, or until the mixture has become a syrupy consistency. Set aside to cool. Pour into bottles and seal. Store in the refrigerator and serve with cold water, soda or mineral water and fresh mint leaves if desired.

**RICH CHOCOLATE SAUCE**

Makes: 1¼ cups

**Ingredients:**

200 g chocolate pieces  
 300 ml cream

**Method:**

Combine chocolate and cream in a 1-litre jug. Cook on P10 for 2 minutes. Mix well. Serve over ice cream.

**STRAWBERRY LIQUEUR**

Makes: 750 ml

**Ingredients:**

500 g sugar  
 500 g washed and hulled strawberries  
 600 g brandy or whisky

**Method:**

Place sugar and strawberries in a 4-litre dish. Stir well. Cook on P10 for 15 minutes. Stir in brandy or whisky. Pour into an airtight container. Store refrigerated for 2 to 3 months. Serve in liqueur glasses or as a tall drink with ice cubes and soda water.

**MINT SAUCE**

Makes: Approximately ¼ cup

**Ingredients:**

¼ cup water  
 1 tablespoon sugar  
 2 tablespoons brown vinegar  
 2 tablespoons mint, finely chopped

**Method:**

Combine all ingredients in 1-cup jug. Cook on P10 for 30 to 60 seconds. Stir well and serve with Roast Lamb.





© Panasonic Home Appliances Microwave Oven (Shanghai) Co., Ltd. 2010.

F00039U20QP  
IP0710-0  
Printed in China