

Panasonic®



MICROWAVE COOKERY BOOK & OPERATING INSTRUCTIONS

FOR MODELS: NN-SD466 / NN-SD456 / NN-SD446

Standard Conversion Chart

Weight

1/2oz	–	15g
1oz	–	25g
2oz	–	50g
3oz	–	75g
4oz	–	100g
5oz	–	150g
6oz	–	175g
7oz	–	200g
8oz	–	225g
9oz	–	250g
10oz	–	275g
11oz	–	300g
12oz	–	350g
13oz	–	375g
14oz	–	400g
15oz	–	425g
1lb/16oz	–	450g

Capacity

1/2tsp	–	3ml
1tsp	–	5ml
1tbsp	–	15ml
1/4pt	–	150ml
1/2pt	–	300ml
3/4pt	–	450ml
1pt	–	600ml
13/4pt	–	1 litre

When using recipes in this book always follow metric or imperial measurements. Do not combine the two. In some recipes the conversions are not a direct equivalent due to recipe result.

Important Notice

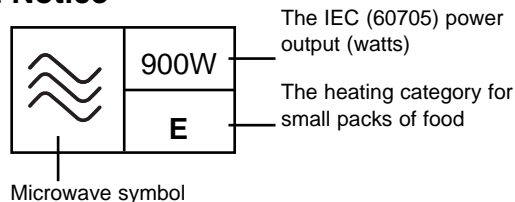

Your oven is rated 900 Watts (IEC)*. When using other cookbooks remember to adjust cooking times accordingly. The symbol above, which is displayed on your oven door, indicates the heating category for your oven when cooking or reheating convenience foods.

Your oven is rated 'E', which is very efficient. It is therefore very important that you refer carefully to the packet instructions on convenience foods. Some packet instructions only display information for B or D rated ovens. We therefore provide additional guidelines for reheating on pages 25-33 of this book. ALWAYS check the progress of the food as it cooks or reheats by simply opening the door and after checking the progress of the foods press START to continue the cooking time.

*1000 Watts IEC (60705) is achieved by using the Turbo Reheat pad, see page 16 for details.

Failure to follow the instructions given in this Cookbook and Operating Instructions, may affect the recipe result and in some instances may be dangerous.



COOKERY ADVICE LINE 01344 862108 (Opens 3 days a week)

Customer Care Centre **08705 357357**

Selected Spares and Accessories:

Order direct on line at www.panasonic.co.uk or by telephoning the Customer Care Centre number above.

Welcome to Panasonic Microwave Cooking

Dear Owner,

Thank you for purchasing a Panasonic Microwave Oven. Even if this is not your first microwave oven, do please read the opening chapters of this cookbook to achieve perfect results every time



This microwave oven has the benefit of the Inverter System Inside. The new unique technology has been in use with microwave ovens in Japan for many years, improving the cooking performance of the oven. It also means that you benefit from having more space inside your oven, without taking up more room on your work surface.

Microwaves leave most foods tastier and leave you with less washing up, but don't expect to become a perfect microwave cook overnight – some of the methods are very different to those used in conventional cooking.

Home Economists program the ovens especially for the UK market. The recipes are also tested many times to ensure you achieve successful results

We hope you enjoy using your new oven but should you require any further help or explanation, phone our

COOKERY ADVICE LINE 01344 862108 (Opens 3 days a week)

Home economists will provide friendly guidance on queries relating to recipes & cooking in your microwave. Alternatively, write to the address below or contact us on-line at:

test.kitchen@panasonic.co.uk

Or visit our website at **www.cooking-corner.co.uk**

The Microwave Test & Development Kitchen

Panasonic Consumer Electronics U.K

Willoughby Road

Bracknell

Berks

RG12 8FP

When writing, be sure to state your model number and daytime telephone number.

CONTENTS

Safety Information	2
Unpacking your oven	3
Care and Cleaning	4
Parts of your oven	5
Important Information	6-7
Microwaving Principles	8
General Guidelines	9-10
Containers to use	11-12
Control Panel	13
Operating Instructions	14-20
Auto Weight Cooking - NN-SD466/NN-SD456	21-22
NN-SD446	23
Reheating Guidelines	24
Reheating Charts	25-28
Cooking Charts	29-33
Increasing/ Decreasing Recipes	34

RECIPES

Soups and Starters	35
Fish	36-38
Meat and Poultry	39-42
Pasta and Rice	43-44
Cheese and Egg Dishes	45-46
Vegetables/Vegetarian	47-50
Puddings and Desserts	51-53
Sauces	54
Baking	55-56
Preserves	57-58
Technical Specification	59
Building in your Oven	59
Index	61-62



Important safety instructions

Read carefully and keep for future reference

This appliance is supplied with a moulded three pin mains plug for your safety and convenience, which may be marked, and rated, either 10 amps or 13 amps.

A 10 amp or 13 amp fuse is fitted according to the type of mains plug fitted.

Should the fuse need to be replaced, please ensure that the replacement fuse has the correct rating for the type of mains plug fitted and that it is approved by ASTA or BSI to BS1362.

Check for the ASTA mark  or the BSI mark  on the body of the fuse.

If the fuse cover is detachable, never use the plug with the cover omitted. A replacement fuse cover can be purchased from your local Panasonic Dealer.

HOW TO REPLACE THE FUSE

Open the fuse compartment with a screwdriver and replace the fuse.

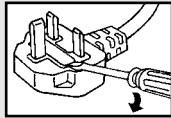

IF THE FITTED MOULDED PLUG IS UNSUITABLE FOR THE SOCKET OUTLET IN YOUR HOME THEN THE FUSE SHOULD BE REMOVED AND THE PLUG CUT OFF AND DISPOSED OF SAFELY AND AN APPROPRIATE ONE FITTED. THERE IS A DANGER OF SEVERE ELECTRICAL SHOCK IF THE CUT OFF PLUG IS INSERTED INTO ANY 13 AMP SOCKET.

If a new plug is to be fitted, please observe the wiring code as shown opposite. If in any doubt, please consult a qualified electrician. (For U.K. Models only)

WARNING: THIS APPLIANCE MUST BE EARTHED.

IMPORTANT: The wires in this mains lead are coloured in accordance with the following code: Green-and-yellow: Earth. Blue: Neutral. Brown: Live.

As the colours of the wire in the mains lead of this appliance may not correspond with the coloured markings identifying the terminals in your plug, proceed as follows:

The wire which is coloured GREEN-AND-YELLOW must be connected to the terminal in the plug which is marked with the letter E or by the Earth symbol  or coloured GREEN or GREEN-AND-YELLOW.

The wire which is coloured BLUE must be connected to the terminal in the plug which is marked with the letter N or coloured BLACK.

The wire which is coloured BROWN must be connected to the terminal in the plug which is marked with the letter L or coloured RED.

When this oven is installed it should be easy to isolate the appliance from the electricity supply by pulling out the plug or operating a circuit breaker.

Voltage & Power

The voltage used must be the same as specified on this microwave oven. Using a higher voltage than that which is specified is dangerous and may result in a fire or other type of accident causing damage.

Do not immerse cord, plug or oven in water. Keep cord away from heated surfaces. Do not let cord hang over the edge of table or work top. Do not plug your oven in via an extension cable as this can be dangerous. It is important to plug the oven directly into a wall socket.

The back of the appliance heats up during use. Do not allow the cord to be in contact with the back of the appliance or cabinet surface.

Unpacking your oven

1. Examine Your Oven

Unpack oven, remove all packing material, and examine the oven for any damage such as dents, broken door latches or cracks in the door. Notify dealer immediately if unit is damaged. Do NOT install if unit is damaged.

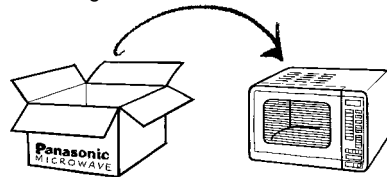

2. Guarantee

Your receipt is your guarantee, please keep safely.

3. Cord

If the supply cord of this appliance is damaged, it must be replaced by the manufacturer or its service agent or a similarly qualified person in order to avoid a hazard.

N.B. The appliance should be inspected for damage to the door seals and door seal areas. If these areas are damaged the appliance should not be operated until it has been repaired by a service technician trained by the manufacturer.

Placement of your oven

Counter Top:

This oven is intended for counter-top or built-in use only. It is not intended for use inside a cabinet or cupboard. Refer to Building-In your oven on page 59.

1. Oven must be placed on a flat, stable surface 850mm above floor level. For proper operation, the oven must have sufficient air flow. i.e. 5cm/2" at one side, the other being open; 15cm/6" clear over the top; 10cm/4" at the rear.

2. Do not place the microwave oven on a shelf directly above a gas or electric hob. This may be a safety hazard and the oven may be damaged.

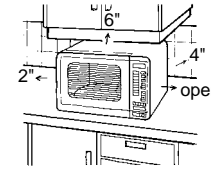

3. Do not block air vents on the rear and bottom or top of the cabinet. Do not place any articles on the top of the oven over the vents. If air vents are blocked during operation, the oven may overheat. If the oven overheats, a thermal safety device will turn the oven off. The oven will remain inoperable with blank display until it has cooled.

4. Do not use outdoors.

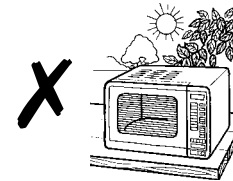

Using your oven

1. The appliance must not be operated by Microwave WITHOUT FOOD IN THE OVEN. Operation when empty will damage the appliance.

2. Only allow children to use the oven without supervision when adequate instructions have been given so that the child is able to use the oven in a safe way and understands the hazards of improper use.



3. Storage of Accessories

Do not store any objects other than oven accessories inside the oven in case it is accidentally turned on. In case of electronic failure, oven can only be turned off at wall socket.

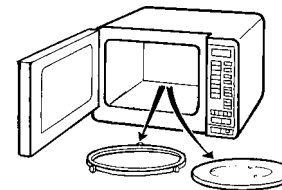

Care & Cleaning of your Microwave Oven - **IMPORTANT**

It is essential for the safe operation of the oven that it is kept clean, and wiped out after each use. Failure to maintain the oven in a clean condition could lead to deterioration of a surface that could adversely affect the life of the appliance and possibly result in a hazardous situation.

1. **Switch the oven off** before cleaning and unplug at socket if possible.
2. **Keep the inside of the oven, door seals and door seal areas clean.** When food splatters or spilled liquids adhere to oven walls, door seals and door seal areas wipe off with a damp cloth. Mild detergent may be used if they get very dirty. The use of harsh detergents or abrasives is not recommended.
3. The **outside oven surface** should be cleaned with a damp cloth. To prevent damage to the operating parts inside the oven, water should not be allowed to seep into the ventilation openings.
4. If the **Control Panel** becomes dirty, clean with a soft, dry cloth. Do not use harsh detergents or abrasives on Control Panel. When cleaning the Control Panel, leave the oven door open to prevent the oven from accidentally turning on. After cleaning touch STOP/CANCEL Pad to clear display window.
5. **If steam accumulates** inside or around the outside of the oven door, wipe with a soft cloth. This may occur when the microwave oven is operated under high humidity conditions and in no way indicates a malfunction of the unit or microwave leakage.
6. It is occasionally necessary to remove the **glass turntable** for cleaning. Wash the turntable in warm soapy water.
7. The **roller ring and oven cavity floor** should be cleaned regularly to avoid excessive noise. Simply wipe the bottom surface of the oven, particularly the turntable spindle and the area surrounding this, with mild detergent and hot water then dry with a clean cloth. The roller ring may be washed in mild soapy water. Cooking vapours collect during repeated use but in no way affect the bottom surface or the roller ring wheels. After removing the roller ring from the cavity floor for cleaning, be sure to replace it in the proper position.
8. A steam cleaner is not to be used for cleaning.

Maintenance of your oven

1. **Service**

WHEN YOUR OVEN REQUIRES SERVICING call your local Panasonic engineer (08705 357357 Customer Support). It is hazardous for anyone other than a competent person to carry out any service or repair operation which involves the removal of a cover which gives protection against exposure to microwave energy.

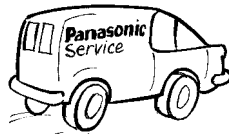

2. **Door Seals**

Do not attempt to tamper with or make any adjustments or repairs to door, control panel housing, safety interlock switches or any other part of the oven. Do not remove outer panel from oven. The door seals and door seal areas should always be kept clean – use a damp cloth.

N.B. The appliance should be inspected for damage to the door seals and door seal areas. If these areas are damaged the appliance should not be operated until it has been repaired by a service technician trained by the manufacturer.

3. **Oven Light**

The oven lamp must be replaced by a service technician trained by the manufacturer. **DO NOT** attempt to remove the outer casing from the oven.

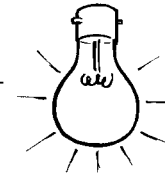

4. **Selected Spares and Accessories**

These may be ordered direct; on line at www.panasonic.co.uk or by telephoning the Customer Care Centre 08705 357357. Most major credit and debit cards accepted. Ensure you quote the correct model number.

Parts of Your Oven

1. Do not operate the oven without the Roller Ring and Glass Turntable in place.
2. Only use the Glass Turntable specifically designed for this oven. Do not substitute with any other Glass Turntable.
3. If Glass Turntable is hot, allow to cool before cleaning or placing in water.
4. Do not cook directly on Glass Turntable. Always place food in a microwave safe dish. The only exception to this is when cooking Jacket Potatoes or Auto Program Jacket Potatoes.
5. If food or utensil on Glass Turntable touches oven walls, causing the turntable to stop moving, it will automatically rotate in the opposite direction. This is normal. Open oven door, reposition the food and restart.
6. The Glass Turntable can rotate in either direction. The maximum weight that can be placed on the turntable is 4 Kg (8 lb 14 oz) (this includes total weight of food and dish).
7. While cooking by MICROWAVE the turntable may vibrate. This will not affect cooking performance.
8. Arcing may occur if the incorrect weight of food is used or a metal container has been used accidentally. If this occurs, stop the machine immediately.

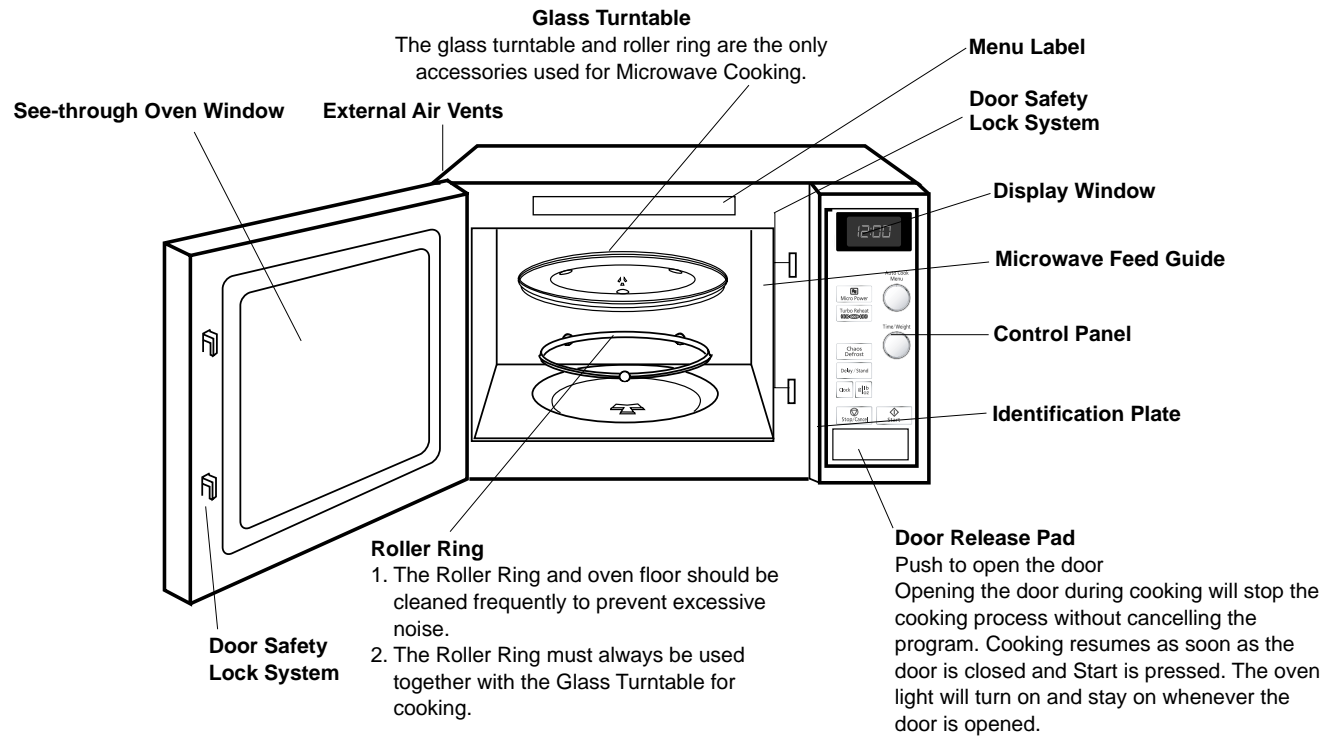

Important Information – Read Carefully

Safety

If smoke or a fire occurs in the oven, press Stop/Cancel pad and leave the door closed in order to stifle any flames. Disconnect the power cord, or shut off the power at the fuse or the circuit breaker panel.

Short Cooking Times

As microwave cooking times are much shorter than other cooking methods it is essential that recommended cooking times are not exceeded without first checking the food.

Cooking times given in the cookbook are approximate. Factors that may affect cooking times are: preferred degree of cooking, starting temperature, altitude, volume, size and shape of foods and utensils used. As you become familiar with the oven, you will be able to adjust these factors.

It is better to undercook rather than overcook foods. If food is undercooked, it can always be returned to the oven for further cooking. If food is overcooked, nothing can be done. Always start with minimum cooking times.

Important.

If the recommended cooking times are exceeded the food will be spoiled and in extreme circumstances could catch fire and possibly damage the interior of the oven.



1. Small quantities of food.

Take care when heating small quantities of food as these can easily burn, dry out or catch fire if cooked too long. Always set short cooking times and check the food frequently.

NEVER OPERATE THE OVEN WITHOUT FOOD INSIDE ON MICROWAVE.

2. Foods low in moisture.

Take care when heating foods low in moisture, eg bread items, chocolate, popcorn, biscuits and pastries. These can easily burn, dry out or catch on fire if cooked too long.

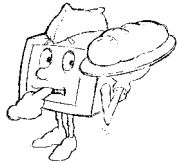

3. Christmas Pudding.

Christmas puddings and other foods high in fats or sugar, eg. jam, mince pies, must not be over heated. These foods must never be left unattended as with over cooking these foods can ignite.

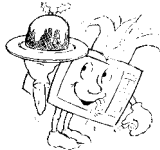

4. Boiled Eggs.

Eggs in their shell and whole hard-boiled eggs should not be heated in microwave ovens since they may explode even after microwave heating has ended.

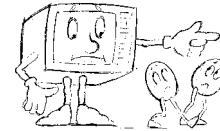

5. Foods with Skins.

Potatoes, apples, egg yolk, whole vegetables and sausages are examples of food with non porous skins. These must be pierced using a fork before cooking to prevent bursting.

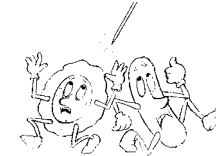

6. Liquids.

Liquids and other foods must not be heated in sealed containers since they are liable to explode. When heating liquids, eg soup, sauces and beverages in your microwave oven, overheating the liquid beyond boiling point can occur without evidence of bubbling.

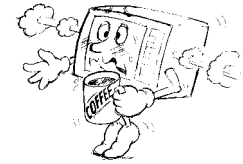

This could result in a sudden boil over of the hot liquid. To prevent this possibility the following steps should be taken:

- Avoid using straight-sided containers with narrow necks.
- Do not overheat.
- Stir the liquid before placing the container in the oven and again halfway through the heating time.
- After heating, allow to stand in the oven for a short time, stirring again before carefully removing the container.
- Microwave heating of beverages can result in delayed eruptive boiling, therefore care should be taken when handling the container.

7. Lids.

Always remove the lids of jars and containers and takeaway food containers before you microwave them. If you don't then steam and pressure might build up inside and cause an explosion even after the microwave cooking has stopped.

8. Deep Fat Frying.

Do not attempt to deep fat fry in your oven.

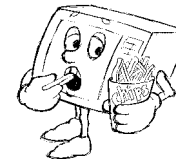

Important Information – Read Carefully

9. Meat Thermometer.

Use a meat thermometer to check the degree of cooking of roasts and poultry only when meat has been removed from the microwave. If undercooked, return to the oven and cook for a few more minutes at the recommended power level. Do not leave a conventional meat thermometer in the oven when microwaving.

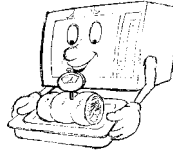

10. Paper, Plastic.

When heating food in plastic or paper containers, keep an eye on the oven due to the possibility of ignition. Do not use wire twist-ties with roasting bags as arcing will occur.

Do not use re-cycled paper products, eg Kitchen roll unless they say they are specifically designed for use in a microwave oven. These products contain impurities which may cause sparks and/or fires when used.

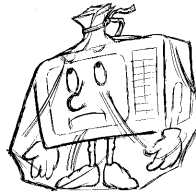

11. Reheating.

It is essential that reheated food is served "piping hot".

Remove the food from the oven and check that it is "piping hot", ie steam is being emitted from all parts and any sauce is bubbling. (If you wish you may choose to check the food has reached 72°C with a food thermometer – but remember do not use this thermometer inside the microwave.)

For foods that cannot be stirred, eg lasagne, shepherds pie, the centre should be cut with a knife to test it is well heated through. Even if a manufacturer's packet instructions have been followed always check the food is piping hot before serving and if in doubt return your food to the oven for further heating.

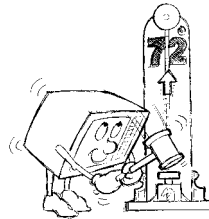

12. Standing Time.

Standing time refers to the period at the end of cooking or reheating when food is left before being eaten, ie. it is a rest time which allows the heat in the food to continue to conduct to the centre, thus eliminating cold spots.

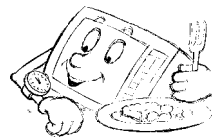

13. Keeping Your Oven Clean.

It is essential for the safe operation of the oven that it is wiped out regularly. Use warm soapy water, squeeze the cloth out well and use to remove any grease or food from the interior. Pay particular attention to the door seal area and also the areas around the microwave feed guide situated on the right hand side of the cavity wall. The oven should be unplugged when cleaning.

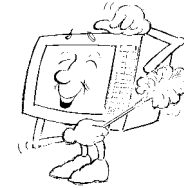

14. Fan Motor Operation.

After using the microwave the fan motor may rotate for a few minutes to cool the electric components. This is normal and you can take out food even though the fan motor operates. You can continue using the oven during this time.

15. Utensils.

Before use check that utensils/containers are suitable for use in microwave ovens.

16. Babies Bottles and Food Jars.

When reheating babies bottles always remove top and teat. Liquid at the top of the bottle will be much hotter than that at the bottom and must be shaken thoroughly before checking the temperature. The lid must also be removed from babies food jars, the contents must also be stirred or shaken before the temperature is checked. This should be carried out before consumption in order to avoid burns.

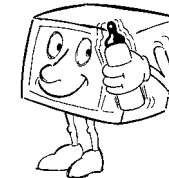

17. Arcing

Arcing may occur if a metal container has been used accidentally or if the incorrect weight of food is used. Arcing is when blue flashes of light are seen in the microwave oven. If this occurs, stop the machine immediately. If the oven is left unattended and this continues it can damage the machine.

18. Maximum weight on turntable

The maximum weight that can be placed on the turntable is 4 Kg (8 lb 14 oz) (this includes total weight of food and dish).

Microwaving Principles

Microwave energy has been used in this country to cook and reheat food since early experiments with RADAR in World War II. Microwaves are present in the atmosphere all the time, both naturally and from manmade sources.

Manmade sources include radar, radio, television, telecommunication links and car phones.

HOW MICROWAVES COOK FOOD

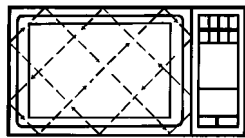
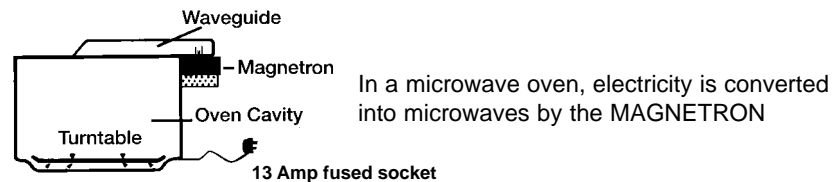

REFLECTION

The microwaves bounce off the metal walls and the metal door screen.



TRANSMISSION

Then they pass through the cooking containers to be absorbed by the water molecules in the food, all foods contain water to a more or lesser extent.

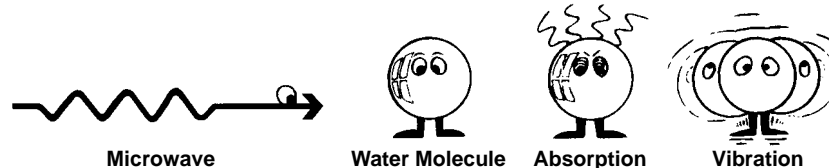

The microwaves cause the water molecules to vibrate which causes FRICTION, ie. HEAT. This heat then cooks the food. Microwaves are also attracted to fat and sugar particles, and foods high in these will cook more quickly. Microwaves can only penetrate to a depth of 1½-2 inches (4-5 cm) and as heat spreads through the food by conduction, just as in a traditional oven, the food cooks from the outside inwards.

IMPORTANT NOTES

The dish used to cook or reheat the food will get warm during cooking, as the heat conducts from the food. Even in microwaving, oven gloves are required!

MICROWAVES CANNOT PASS THROUGH METAL AND THEREFORE METAL COOKING UTENSILS CAN NEVER BE USED IN A MICROWAVE, FOR COOKING ON MICROWAVE ONLY

Foods Not Suitable for Cooking by Microwave Only

Yorkshire Puddings, Souffles, Double Crust Pastry Pies.

Because these foods rely on dry external heat to cook correctly, do not attempt to cook by microwave.

Foods that require deep fat frying cannot be cooked either.

Boiled Eggs

Do not boil eggs in your microwave. Raw eggs boiled in their shells can explode and cause serious injury

STANDING TIME

When a microwave oven is switched off, the food will continue to cook by conduction – NOT BY MICROWAVE ENERGY. Hence STANDING TIME is very important in microwaving, particularly for dense foods i.e. meat, cakes and reheated meals. (Refer to page 9.)

General Guidelines

STANDING TIME



Dense foods e.g. meat, jacket potatoes and cakes, require a **STANDING TIME** (inside or outside of the oven) after cooking, to allow heat to finish conducting to cook the centre completely.

- **MEAT JOINTS** – Stand 15 mins. wrapped in aluminium foil.
- **JACKET POTATOES** – Stand 5 mins. wrapped in aluminium foil.
- **LIGHT CAKES** – Stand 5 mins. before removing from dish.
- **RICH DENSE CAKES** – Stand 15-20 mins.
- **FISH** – Stand 2-5 mins.
- **EGG DISHES** – Stand 2-3 mins.
- **PRECOOKED CONVENIENCE FOODS** – Stand for 5 mins.
- **PLATED MEALS** – Stand for 2-5 mins.
- **VEGETABLES** – Boiled potatoes benefit from standing 1-2 mins., however most other types of vegetables can be served immediately.
- **DEFROSTING** – It is essential to allow standing time to complete the process. This can vary from 5 mins. e.g. raspberries, to up to 1 hour for a joint of meat.

If food is not cooked after **STANDING TIME**, return to oven and cook for additional time.

PIERCING

The skin or membrane on some foods will cause steam to build up during cooking. These foods must be pierced or a strip of skin should be peeled off before cooking to allow the steam to escape. Eggs, potatoes, apples, sausages etc, will all need to be pierced before cooking. **DO NOT ATTEMPT TO BOIL EGGS IN THEIR SHELLS.**



MOISTURE CONTENT

Many fresh foods e.g. vegetables and fruit, vary in their moisture content throughout the season. Jacket potatoes are a particular example of this. For this reason cooking times may have to be adjusted throughout the year. Dry ingredients e.g. rice, pasta, can dry out further during storage and cooking times may differ from ingredients freshly purchased.

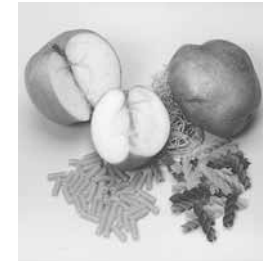

CLING FILM

Cling film helps keep the food moist and the trapped steam assists in speeding up cooking times. However it should be pierced before cooking, to allow excess steam to escape. Always take care when removing cling film from a dish as the build-up of steam will be very hot. Always purchase cling film that states on the packet "suitable for microwave cooking" and use as a covering only. Do not line dishes with cling film.





DISH SIZE

Follow the dish sizes given in the recipes, as these affect the cooking and reheating times. A quantity of food spread in a bigger dish cooks and reheats more quickly.



QUANTITY

Small quantities cook faster than large quantities, also small meals will reheat more quickly than large portions.



SPACING

Foods cook more quickly and evenly if spaced apart. NEVER pile foods on top of each other.



SHAPE

Even shapes cook evenly. Food cooks better by microwave when in a round container rather than square.

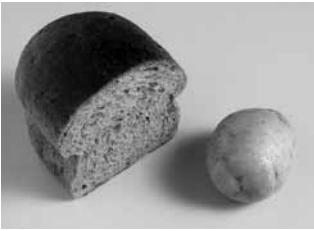

DENSITY

Porous airy foods heat more quickly than dense heavy foods.



COVERING

Cover foods with microwave cling film or a self-fitting lid. Cover fish, vegetables, casseroles, soups. Do not cover cakes, sauces, jacket potatoes, pastry items.



ARRANGING

Individual foods e.g. chicken portions or chops, should be placed on a dish so that the thicker parts are to the outside.



STARTING TEMPERATURE

The colder the food, the longer it takes to heat up. Food from a fridge takes longer to reheat than food at room temperature.



TURNING AND STIRRING

Some foods require stirring during cooking. Meat and poultry should be turned after half the cooking time.



LIQUIDS

All liquids must be stirred **before** and **during** heating. Water especially must be stirred before and during heating, to avoid eruption. Do not heat liquids that have previously been boiled. DO NOT OVERHEAT.



CHECKING FOOD

It is essential that food is checked during and after a recommended cooking time, even if an AUTO PROGRAM has been used (just as you would check food cooked in a conventional oven). Return the food to the oven for further cooking if necessary.



CLEANING

As microwaves work on food particles, keep your oven clean at all times. Stubborn spots of food can be removed by using a branded microwave spray cleaner, sprayed onto a soft cloth, always wipe the oven dry after cleaning.

Containers to use

Choosing the correct container is a very important factor in deciding the success or failure of your cooking.

Testing Dishes for Suitability



When unsure that a cooking container is suitable for use in your microwave, check by the following test:

1. Fill a microwave safe measuring jug with 300ml ($\frac{1}{2}$ pt) cold water.
2. Place it on the turntable alongside the dish to be tested. If the dish you are testing is a large dish, then stand the measuring jug on top of the empty dish.
3. Heat on HIGH power for 1 minute.

Result

If the dish is suitable for microwaving, it will remain cool, whilst the water in the jug will begin to feel warm. If the testing dish feels warm, do not use as it is obviously absorbing microwave energy.

N.B. This test does not apply to plastic or metal based containers e.g. Le Creuset® style dishes, which should not be used as they are cast iron covered with enamel.

QUICK CHECK GUIDE TO COOKING UTENSILS



OVEN GLASS

Everyday glass that is heat resistant e.g. Pyrex®, is ideal. Do not use delicate glass which may crack due to the heat from the food. Do not use lead crystal which may crack or arc.

POTTERY, EARTHENWARE, STONEWARE

If completely glazed, these dishes are suitable. Do not use if partially glazed or unglazed, since they are able to absorb water which in turn absorbs microwave energy, making the container very hot and slows down the cooking of food.



CHINA AND CERAMIC

Everyday glazed china plates, saucers, bowls, mugs and cups can be used if they are heat resistant. Porcelain and ceramic are also ideal. Fine bone china should only be used for reheating for short periods, otherwise the change in temperature may crack

the dish or craze the finish. Do not use dishes with a metal rim or pattern. Do not use jugs or mugs with glued handles, since the glue can melt in a microwave.

FOIL/METAL CONTAINERS

NEVER ATTEMPT TO COOK IN FOIL OR METAL containers – the microwaves cannot pass through and the food will not heat evenly – this may also damage your oven. Small items in shallow foil containers can be REHEATED in the microwave, but take care that containers do not touch the oven walls or door. Use wooden kebab sticks instead of metal skewers. DO NOT RE-USE FOIL CONTAINERS AS THEY MAY BECOME DENTED OR DAMAGED AND ARCING MAY OCCUR.



PLASTIC

Many plastic containers are designed for microwave use. Only use Tupperware® containers if they are designed for microwave use. Do not use Melamine – although it



is heat resistant it absorbs microwave energy and scorches. Even if a container is microwave safe, do not use for cooking foods high in sugar or fat. Foods that require long cooking times e.g. brown rice, should not be cooked in plastic. Never cook in margarine cartons or yoghurt pots, as these will melt with the heat from the food. Many plastics that are not heatproof for cooking are suitable for defrosting.



PAPER

Plain white absorbent kitchen paper (kitchen towel) can be used for covering blind pastry cases and for covering bacon to prevent splattering BUT FOR SHORT COOKING TIMES ONLY. NEVER RE-USE A PIECE OF KITCHEN TOWEL. ALWAYS USE A FRESH PIECE OF PAPER FOR EACH DISH.



Avoid kitchen paper containing manmade fibres. If you are using branded re-cycled kitchen towel, check first that it is recommended for microwave use. Do not use waxed or plastic coated cups or plates as the finish may melt in the oven. Greaseproof paper can be used to line the base of dishes and to cover fatty foods e.g. bacon rashers to stop them splattering. White paper plates can be used for SHORT REHEATING TIMES.



WICKER, WOOD, STRAW BASKETS

Do not use these items in your microwave. With continued use and with prolonged exposure they will crack and could ignite. Do not use wooden dishes in your microwave.

CLING FILM

Microwave cling film can be used for covering food that is



reheated by microwave. It is also useful for covering food to be cooked, but care should be taken to avoid the film being in direct contact with the food.

ROASTING BAGS

Roasting bags are useful when slit up one side to tent a joint for roasting by power and time. Do not use the metal twists supplied.



ALUMINIUM FOIL

Small amounts of smooth aluminium foil can be used to SHIELD joints of meat during defrosting and cooking, as the microwaves cannot pass through the foil, this prevents the parts shielded from overcooking or overdefrosting. Take care that the foil does not touch the sides or roof of the oven, as this may cause arcing and damage your oven.

Control Panel

NN-SD466/NN-SD456/NN-SD446*

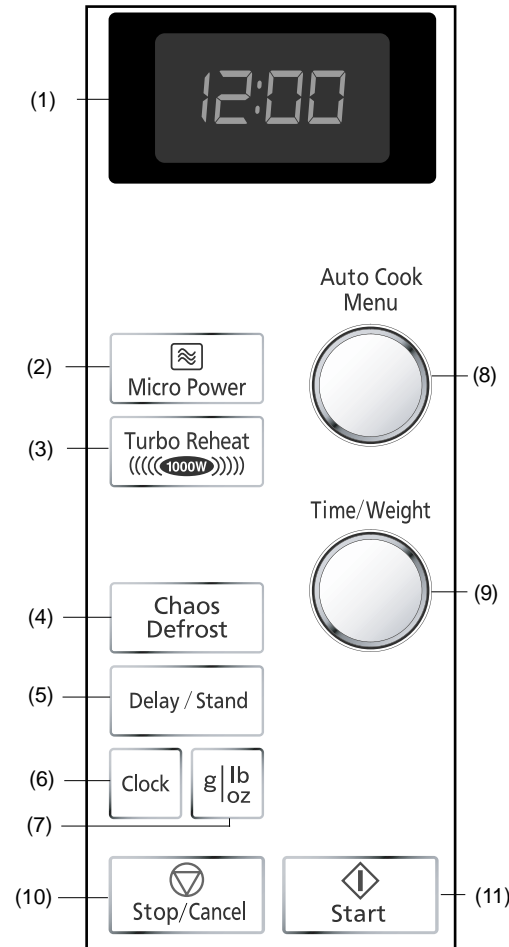

* The design of your control panel may vary from the panel displayed (depending on colour), but the words on the pads will be the same.

- (1) **Display Window**
- (2) **Microwave Power Setting**
- (3) **Turbo Reheat**
- (4) **Auto Weight Defrost Programs**
- (5) **Delay/Stand Pad:**
This can be used to delay a cooking program for up to 9 hrs 90 mins., or used to time or for standing (non-cooking) time.
- (6) **Clock Pad:**
Press the clock pad. Using the Time/Weight Dial set the clock (12 hr clock). Press clock pad again to stop colon flashing.
- (7) **lb/oz Conversion Pad**
- (8) **Auto Cook Menu Dial**
- (9) **Time/Weight Dial**
- (10) **Stop/Cancel Pad:**
Before Cooking:
one press clears your instructions.
During Cooking:
one press temporarily stops the cooking program. Another press cancels all your instructions and the time of day will appear in the display.
- (11) **Start Pad:**
Press to start operating the oven. If during cooking the door is opened or Stop/Cancel Pad is pressed once, Start Pad has to be pressed again to continue cooking.

Beep Sound:

A beep sounds when a pad is pressed. If this beep does not sound, the setting is incorrect. When the oven changes from one function to another, two beeps sound. After completion of cooking, five beeps sound.

Let's Start to Use your Oven

NN-SD466/NN-SD456
NN-SD446*

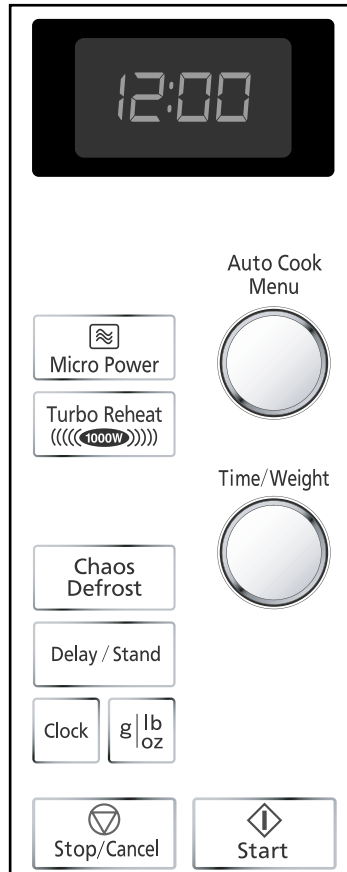

* The design of your control panel may vary from the panel displayed (depending on colour), but the words on the pads will be the same.

1 Plug in

Plug into a 13 amp fused electrical socket. You will be reminded to read your operating instructions.

2 Press Clock Pad

Set clock as a 12hr clock. Set time using Time/Weight Dial. Press clock pad again. (See page 15 for details).

3 Demonstration Mode

This is to enable you to experiment setting various programs. (The letter D will always appear in the display window. This is to confirm that there is no microwave power produced and it is safe to use the oven without any food). To select this mode press the clock pad three times. "Demo Mode Press Any Key" will appear in the display window.

4 Select Power

For example - For HIGH power, press MICRO POWER PAD once.

5 Enter Time Using Time/Weight Dial

To set a cooking time eg. 1 minute, turn time /weight dial until 1 minute is displayed.

6 Press Start Pad

The time will be displayed in the window and count down. The oven will beep at the end of the cooking program. Check that the letter **D** appears in the display window, to confirm no microwave power is being produced, and it is safe to use the oven without any food. To cancel the demonstration mode press the clock pad a further three times.

7 Child Lock

To operate the child lock facility press the start pad three times, this will deactivate the microwave. "Lock" will appear in the display and none of the controls will operate. To clear child lock facility press Stop/Cancel three times.

Setting the Clock



- **Press Clock Pad**

“SET TIME” will appear in the display window, and the colon starts to blink.

- **Turn Time/Weight Dial**

Enter time of day by using the Time/Weight Dial. Time counts up in minutes. Turning the dial slowly will count up in 1 minute steps. Turning the dial quickly will count up in 10 minute steps. Set as a 12 hour clock.

- **Press Clock Pad**

Colon stops blinking. Time of day is now locked into the display.

N.B.

1. To reset time of day, repeat step 1 through to step 3.
2. The clock will keep the time of day as long as the oven is plugged in and electricity is supplied.
3. This is a 12 hour clock.

Microwave Cooking and Defrosting

There are 6 different microwave power levels available.

Selecting Microwave Power Level



- Press this Pad until the power you require appears in the display window.

Press	Power Level	Wattage
once	High	900 W
twice	Defrost	270 W
3 times	Medium	600 W
4 times	Low	440 W
5 times	Simmer	250 W
6 times	Warm	100 W

Time/Weight



- Enter the cooking time by using the Time/Weight Dial. 0-8 minutes, time counts up in seconds. Upwards from 8 minutes, time counts up in minutes. **(HIGH Power: Up to 30 minutes). (Other Powers: Up to 99 minutes).**



- Press Start.

CAUTION: The oven will automatically work on HIGH microwave power if a cooking time is entered without the power level previously being selected.

Turbo Reheat

This will provide an added boost of microwave power up to 1000 watts, for the initial part of the cooking time, when reheating foods e.g. soup, baked beans.

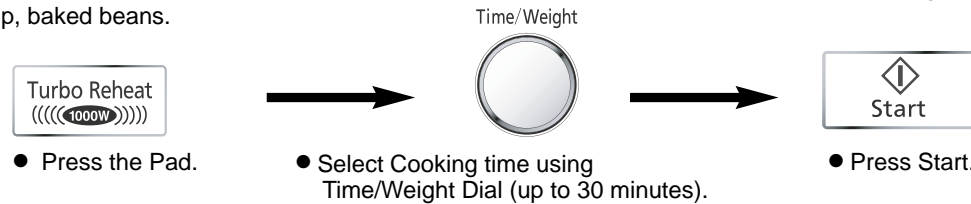

- Press the Pad.
- Select Cooking time using Time/Weight Dial (up to 30 minutes).
- Press Start.

Using the the Delay/Stand Feature

The Delay/Stand Pad is used as a timing pad either before, during or after a cooking program (up to 30 minutes). When the Delay/Stand Pad is selected with a time, there is no microwave power in the oven during this time.

1. To Set a Standing Time:

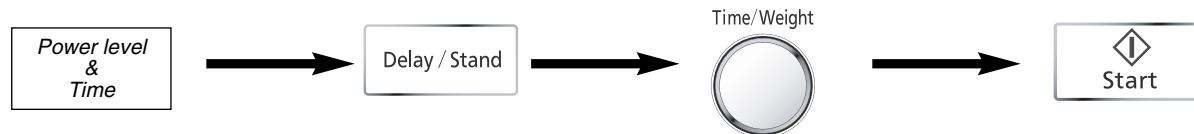

- Set the desired Cooking Program, by selecting power level and time required.
- Then Press the Stand Pad.
- Set desired standing time using the Time/Weight Dial (max 9hrs 90mins). An "H" will appear in the display to denote hours.
- Press Start Pad. Cooking program will commence after which the standing time will count down.

2. To Set a Delay Start:

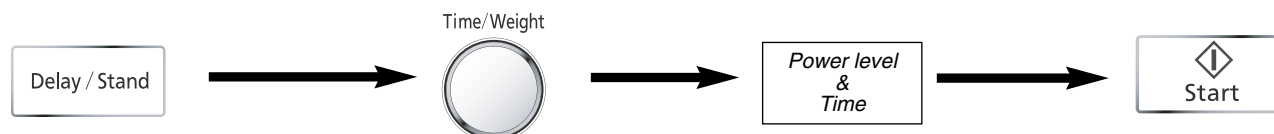

- Press the Delay Pad
- Set Delay time using the Time/Weight Dial (max 9hrs 90mins). An "H" will appear in the display to denote hours.
- Set the complete cooking program, by entering power level and time required.
- Press Start Pad. Delayed time will count down then the cooking program will start.

NB

1. If the oven door is opened during the stand or delay time, the time in the display window will continue to count down.
2. Delay Start cannot be used before an Auto Program.
3. If the Delay Stand pad is pressed three times, this will turn off the auto guide system. "Operation guide off" will appear once. The words will not now scroll in the display window. To turn the auto guide back on, press the Delay/Stand pad three times. "Operation guide on" will appear, and then the words will scroll again.

Microwave Cooking and Defrosting

ACCESSORY TO USE:

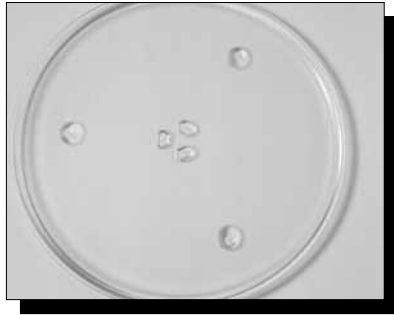

When using your oven, the glass turntable provided must always be in position. DO NOT place food directly onto the turntable except in the case of Jacket Potatoes or Auto Program Jacket Potatoes.

Foods reheated or cooked by MICROWAVE are normally covered with a lid or cling film, unless otherwise stated.

Two Stage Cooking:

eg. High power 10 minutes followed by Simmer power 20 minutes; Select High power and program 10 minutes then select second power (Simmer) with second cooking time (20 minutes) then press Start.

Three Stage Cooking:

eg. High power 5 minutes, Delay 5 minutes, High power 2 minutes; Select first Power level and cooking time, then press DELAY and time, then select final power level and final cooking time. Then press Start.

Auto Weight Defrost

With this feature you can defrost frozen foods according to the weight. Select the category and set the weight of the food. The weight can be programmed in pounds and ounces or grams. The weight starts from the minimum weight for each category.

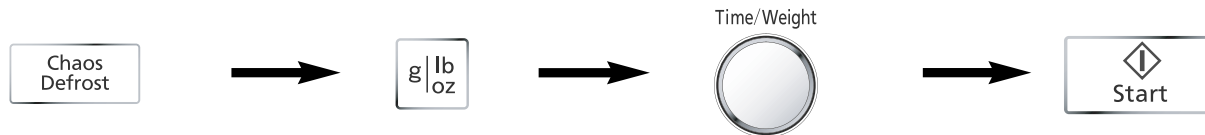

- Select the desired program by pressing pad. Press "CHAOS DEFROST" pad once, twice or three times to select food.

- Press to select g or lb and oz.

- Enter the weight by turning the Time/Weight Dial. The display will start with the minimum weight for each food. Turning the dial slowly will count up in 10 g (or 1 oz) steps. Turning the dial quickly will count up in 100 g (or 10 oz) steps.

- Press Start.

Program	Weight Range	Suitable Foods
1 Bread	100 - 800g (4oz - 1lb 12oz)	Bread and rolls. Turn at beep.
2 Meat Items	150 - 1200g (5oz - 2lb 10oz)	Small pieces of meat, minced meat, chicken portions, steaks, chops. Turn at beeps.
3 Meat Joints	400 - 2000g (14oz - 4lb 6oz)	Whole chicken, meat joints. Turn at beeps and shield.

Auto Weight Defrost Programs

This feature allows you to defrost minced meat, chops, chicken portions, meat joints and bread.

The CHAOS defrost pad should be pressed to select the correct category and then enter in the weight of the food in grams or pounds and ounces using the appropriate pads (See page 17).

Foods should be placed in a suitable dish, whole chickens and joints of meat should be on an upturned saucer or on a rack. Chops, chicken portions and slices of bread should be placed in a single layer. It is not necessary to cover the foods.

The **CHAOS Theory** principle is used in Auto Weight defrost programs to give you a quick and more even defrost.

The CHAOS system uses a random sequence of pulsing microwave energy which speeds up the defrosting process.

During the program the oven will beep to remind you to check the food.

IT IS ESSENTIAL THAT YOU TURN AND STIR THE FOOD FREQUENTLY AND SHIELD IF NECESSARY. (See page 19).

On hearing the first beep you should TURN and SHIELD (if possible). On the second beep you should turn the food or break it up.

1st Beep



Turn

or

1st Beep

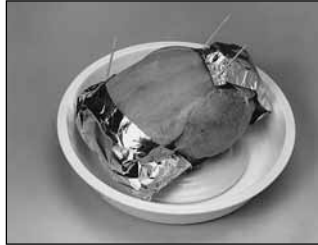

Shield

2nd Beep



Turn or break up

CATEGORY 1 BREAD

The Bread Program is suitable for defrosting small items e.g. rolls, buns and slices of bread which are required for immediate use. Small items may feel warm immediately after defrosting. Loaves can also be defrosted on this program but these will require standing time to allow the centre to thaw out. Standing time can be shortened if slices are separated and buns and loaves cut in half. Items should be turned halfway during defrosting. THIS PROGRAM IS NOT SUITABLE FOR CREAM CAKES OR DESSERTS eg. cheesecake.

Chaos
Defrost

CATEGORY 2 MEAT ITEMS (MINCE/CHOPS/CHICKEN PORTIONS)

It is necessary for mince to be broken up frequently during defrosting and this is best carried out in a large shallow dish. Chops and chicken portions should be arranged in a single layer and turned frequently.

CATEGORY 3 MEAT JOINTS/WHOLE CHICKENS

Meat joints and chickens will require shielding during defrosting especially if they are particularly fatty pieces. This is to prevent over defrosting on the outside edges. Smooth foil secured with cocktail sticks should be used. DO NOT ALLOW THE FOIL TO TOUCH THE WALLS OF THE OVEN. Back fat of joints, legs, wings and breast bones need shielding (see photograph above). Standing time of at least 1 hour should be allowed (rolled joints may require longer) before cooking to ensure the centre is fully defrosted.

Defrosting Guidelines

By selecting the DEFROST power level, from the microwave power pad, and setting a time, you can defrost food in your microwave. The biggest problem is getting the inside defrosted before the outside starts to cook.

For this reason a defrost program alternates between a defrost power and a standing time. The name for this type of defrost is cyclic and during the

standing stages there is not any microwave power in the oven, although the light will remain on and the turntable will turn. The automatic stand times ensure a more even defrost but it is still necessary to allow for standing time before use. Place foods in a suitable container. Meat joints and chickens should be placed on an upturned saucer or on a plastic rack if you have one.



Separate chops and small items e.g. bread slices where possible.

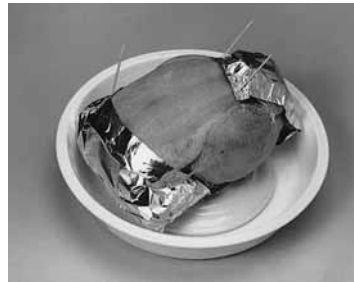

Chickens and joints of meat will require shielding during defrosting.

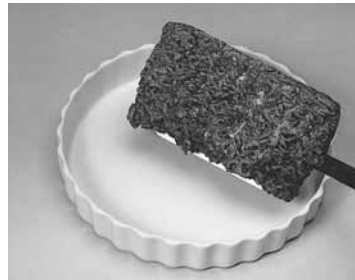

Turn dense foods and meat 2/3 times during defrosting.



Break up small items e.g. minced meat, frequently during defrosting.

TIPS

- 1 *Check foods during defrosting. Foods vary in their defrosting speed.*
- 2 *It is not necessary to cover the food.*
- 3 *Always turn or stir the food especially when the oven "beeps". Shield if necessary (see point 5).*
- 4 *Minced meat/chops/chicken portions should be broken up or separated as soon as possible and placed in a single layer.*
- 5 *Shielding prevents food cooking. It is essential when defrosting chickens and joints of meat. The outside thaws out first, so protect wings/breast/fat with smooth pieces of aluminium foil secured with cocktail sticks.*
- 6 *Allow standing time so that the centre of the food thaws out. (minimum 1 hour for joints of meat and whole chickens).*

Defrosting Foods Using Defrost Power & Time

The times given below are a guideline only. Always check the progress of the food by opening the oven door and then re-starting. For larger quantities adjust times accordingly. Food should not be covered during defrosting.

Meat	Defrosting Time	Method	Standing Time
Beef/Lamb/ Pork Joint	14-16 mins. 450g (1lb)	Place in a suitable dish or on an upturned saucer or use a rack. Turn 3-4 times. Shield.	60 mins.
Minced Beef	12 mins. 450g (1lb)	Place in a suitable dish. Break up and turn 3-4 times.	15 mins.
Chops	10 mins. 450g (1lb)	Place in a suitable dish in a single layer. Turn twice. Shield if necessary.	15 mins.
Sausages	12 mins. 450g (1lb)	Place in a suitable dish in a single layer. Turn twice. Shield if necessary.	15 mins.
Bacon	6-7 mins. 450g (1lb)	Place in a suitable dish in a single layer. Turn twice. Shield if necessary.	10 mins.
Stewing Steak	12 mins. 450g (1lb)	Place in a suitable dish. Break up frequently.	15 mins.
Chicken	13 mins. 450g (1lb)	Place in a suitable dish on an upturned saucer or use a rack. Turn 3-4 times. Shield.	60 mins.
Chicken Portions	10-12 mins. 450g (1lb)	Place in a suitable dish in a single layer. Turn twice. Shield if necessary.	30 mins.
Fish			
Whole	9-10 mins. 450g (1lb)	Place in a suitable dish. Turn Twice. Shield.	15 mins.
Fillet/Steak	7-8 mins. 450g (1lb)	Place in a suitable dish. Turn twice, separate if necessary.	15 mins.
Prawns	6-7 mins. 450g (1lb)	Place in a suitable dish. Stir twice during defrosting.	10 mins.
General			
Bread Sliced	5 mins. 400g (14oz)	Place on the turntable. Separate and rearrange during defrosting.	10 mins.
Slice of bread.	30 sec. 30g (1oz)	Place on the turntable on a piece of kitchen paper.	1-2 mins.
Pastry	5½ mins. 450g (1lb)	Place on a plate. Turn over half way.	10-15 mins.
Soft Fruit	6-7 mins. 450g (1lb)	Place in a suitable dish. Stir twice during defrosting.	10 mins.

Auto Weight Reheat / Cook Programs NN-SD466/SD456/SD446

This feature allows you to cook or reheat foods by setting the weight only. The oven determines the Microwave power level and then the cooking time automatically. Select the category of food and then just enter the weight. The weight can be entered in grams or pounds and ounces. The NN-SD466/NN-SD456 has eight programs and the NN-SD446 six programs.

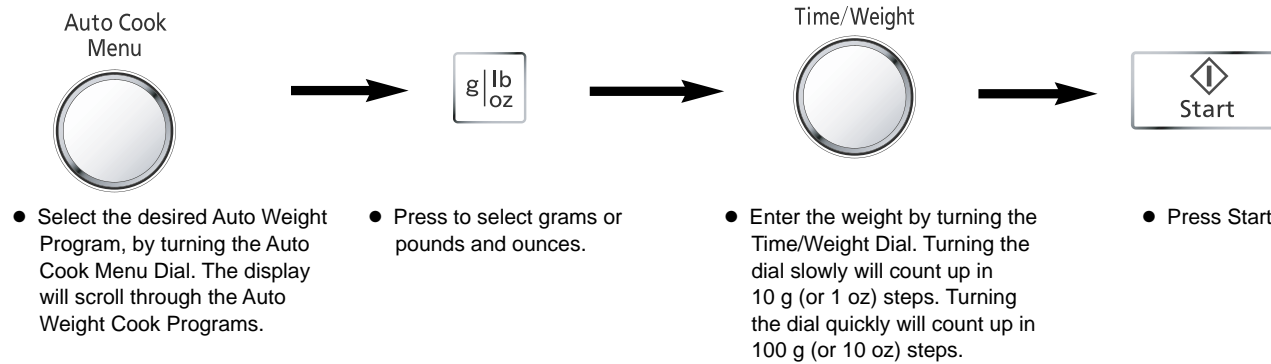

Guidelines for Use

The Auto Weight Programs are designed to take the guesswork out of cooking or reheating your food. They must ONLY be used for the foods described.

1. Only cook foods within the weight ranges described (see appropriate table for your oven below or on page 23).
2. Only use the accessories as indicated on pages 22-23.
3. Always choose a container size that is suitable for the quantities of food, ie. do not allow a large headspace or food may not cook correctly.
4. Always cover the dish with pierced cling film or a lid, this helps keep the food moist. The only exception to this rule is the Jacket Potato program.
5. Most foods benefit from a STANDING time after cooking on an Auto Program, to allow heat to continue conducting to the centre.
6. To allow for some variations that occur in food, check that food is thoroughly cooked and piping hot before serving.

Minimum/Maximum Weights to use on Auto Weight Programs NN-SD466/SD456

Program	Minimum	Maximum
1 Curry	300g (11oz)	800g (1lb 12oz)
2 Chinese	300g (11oz)	450g (1lb)
3 Pasta	300g (11oz)	1500g (3lb 5oz)
4 Casserole	300g (11oz)	1000g (2lb 2oz)
5 Fresh Vegetables	100g (4oz)	800g (1lb 12oz)
6 Fresh Fish	100g (4oz)	800g (1lb 12oz)
7 Jacket Potatoes	200g (7oz)	1500g (3lb 5oz)
8 Boiled Potatoes	200g (7oz)	1000g (2lb 2oz)

Auto Weight Cook Programs for NN-SD466/SD456

Auto Programs must ONLY be used for the foods described below. Place food off centre, unless stated otherwise.

1 Curry



This program is for reheating a chilled curry convenience meal that can be stirred. Foods must be in a suitable single section microwaveable container* and have the film pierced. Place on turntable. Select program 1 using Auto Cook Menu Dial. Enter the weight then press START. Stir halfway. Allow to stand for 1 minute. Ensure that the food is piping hot. Stir the food before serving.

2 Chinese Style

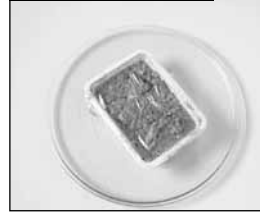

This program is for reheating a chilled chinese style convenience meal that can be stirred. Foods must be in a suitable single section microwaveable container* and have the film pierced. Place on the turntable. Select program 2 using Auto Cook Menu Dial. Enter the weight then press START. Stir halfway. Allow to stand for 1 minute. Ensure food is piping hot. Stir again before serving.

3 Pasta



This program is for reheating a chilled pasta style convenience meal that can be stirred. Foods must be in a suitable single section microwaveable container* and have the film pierced. Place on turntable. Select program 3 using Auto Cook Menu Dial. Enter the weight then press START. Stir halfway. Allow to stand for 1 minute. Ensure that the food is piping hot. Stir the food before serving.

4 Casserole

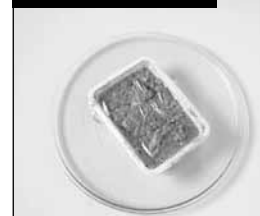

This program is for reheating a chilled casserole style convenience meal that can be stirred. Foods must be in a suitable single section microwaveable container* and have the film pierced. Place on the turntable. Select program 4 using Auto Cook Menu Dial. Enter the weight and press START. Stir halfway. Allow to stand for 1 minute. Ensure food is piping hot. Stir again before serving. Note: Large pieces of meat may require longer cooking.

5 Fresh Vegetables



To cook FRESH vegetables. Place prepared vegetables into a shallow container on turntable. Add 15ml (1tbsp) of water per 100g (4 oz) vegetables. Cover with pierced cling film or lid. Select program 5 using Auto Cook Menu Dial. Enter the weight. Press START.

6 Fresh Fish



To cook FRESH fish. Shield the thinner portions. Place in a shallow container on turntable. Add 15-30ml (1-2tbsp) liquid. Cover with pierced cling film or lid. Select program 6 using Auto Cook Menu Dial. Enter the weight. Press START.

7 Jacket Potatoes



To cook jacket potatoes choose medium sized potatoes 200-250g (7-9oz). Wash and dry and prick with a fork several times. Arrange around edge of turntable. Select program 7 using Auto Cook Menu Dial. Enter weight. Press START. DO NOT COVER. After cooking, wrap in foil and stand for 5 mins.

8 Boiled Potatoes



Cut into even size pieces, arrange in a single layer. For weights below 450g (1lb) add 6tbsp (90ml) water. For large weights add 150ml (1/4pt) water. Cover with pierced cling film or a lid. Select program 8 using Auto Cook Menu Dial. Enter the weight and press START.

*IMPORTANT NOTE:

Meals in bowl shaped containers may require extra cooking time.

Auto Weight Reheat / Cook Programs NN-SD446

Auto Programs must ONLY be used for the foods described below. Place food off centre, unless otherwise stated.

1 Curry

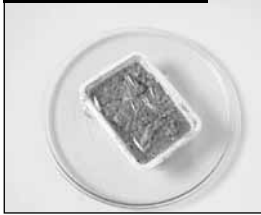

This program is for reheating a chilled curry convenience meal that can be stirred. Foods must be in a suitable single section microwaveable container* and have the film pierced. Place on turntable. Select program 1 using Auto Cook Menu Dial. Enter the weight then press START. Stir halfway. Allow to stand for 1 minute. Ensure that the food is piping hot. Stir the food before serving.

2 Chinese Style

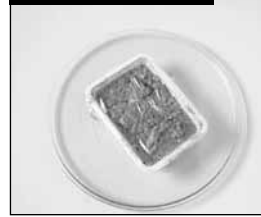

This program is for reheating a chilled chinese style convenience meal that can be stirred. Foods must be in a suitable single section microwaveable container* and have the film pierced. Place on the turntable and Select program 2 using Auto Cook Menu Dial. Enter the weight. Press START. Stir halfway. Allow to stand for 1 minute. Ensure food is piping hot. Stir again before serving.

3 Pasta



This program is for reheating a chilled pasta style convenience meal that can be stirred. Foods must be in a suitable single section microwaveable container* and have the film pierced. Place on turntable. Select program 3 using Auto Cook Menu Dial. Enter the weight then press START. Stir halfway. Allow to stand for 1 minute. Ensure that the food is piping hot. Stir the food before serving.

4 Jacket Potatoes

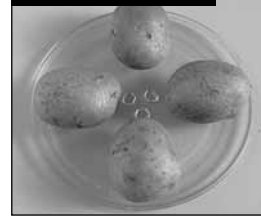

To cook jacket potatoes choose medium sized potatoes 200-250g (7-9oz). Wash and dry and prick with a fork several times. Arrange around edge of turntable. Select program 4 using Auto Cook Menu Dial. Enter weight. Press START. DO NOT COVER. After cooking, wrap in foil and stand for 5 mins.

5 Fresh Vegetables



To cook FRESH vegetables. Place prepared vegetables into a shallow container on turntable. Add 15ml (1tbsp) of water per 100g (4 oz) vegetables. Cover with pierced cling film or lid. Select program 5 using Auto Cook Menu Dial. Enter the weight. Press START.

6 Fresh Fish



To cook FRESH fish. Shield the thinner portions. Place in a shallow container on turntable. Add 15-30ml (1-2tbsp) liquid. Cover with pierced cling film or lid. Select program 6 using Auto Cook Menu Dial. Enter the weight. Press START.

*IMPORTANT NOTE:

Meals in bowl shaped containers may require extra cooking time.

Minimum/Maximum Weights to use on Auto Weight Programs for NN-SD446

Program	Minimum	Maximum
1 Curry	300g (11 oz)	800g (1lb 12oz)
2 Chinese	300g (11 oz)	450g (1lb)
3 Pasta	300g (11 oz)	1500g (3lb 5oz)
4 Jacket Potatoes	200g (7 oz)	1500g (3lb 5oz)
5 Fresh Vegetables	100g (4 oz)	800g (1lb 12oz)
6 Fresh Fish	100g (4 oz)	800g (1lb 12oz)

Cooking and Reheating Guidelines

Most foods reheat very quickly in your oven by HIGH power. Meals can be brought back to serving temperature in just minutes and will taste freshly cooked and NOT leftover. Always check food is piping hot and return to oven if necessary.

As a general rule, always cover wet foods, e.g. soups, casseroles and plated meals.

Do not cover dry foods e.g. bread rolls, mince pies, sausage rolls etc.

The charts on pages 25-33 show you the best way to cook or reheat your favourite foods. The best method depends on the type of food.

Remember when cooking or reheating any food that it should be stirred or turned wherever possible. This ensures even cooking or reheating on the outside and in the centre.

When is food reheated?

Food that has been reheated or cooked should be served "piping hot" i.e. steam should be visibly emitted from all parts. As long as good hygiene practices have been followed during the preparation and storage of the food, then cooking or reheating presents no safety risks.

Foods that cannot be stirred should be cut with a knife to test that they are adequately heated throughout. Even if a manufacturer's instructions or the times in the cookbook have been followed, it is still important to check the food is heated thoroughly. If in doubt, always return to the oven for further reheating.

If you cannot find the equivalent food in the chart then choose a similar type and size listed and adjust the cooking time if necessary.

PLATED MEALS

Everyone's appetite varies and reheat times depend on meal contents. Dense items e.g. mashed potato, should be spread out well. If a lot of gravy is added, extra time may be required. Place denser items to the outside of the plate. Between 3-5 mins. on HIGH power will reheat an average portion. If stacking two meals, heat on HIGH power for 6-7 mins. and change the meals over halfway.

CANNED FOODS

Remove foods from can and place in a suitable dish before heating.

SOUPS

Use a bowl and stir before heating and at least once through reheat time and again at the end.

CASSEROLES

Stir halfway through and again at the end of heating.

MINCE PIES - CAUTION

REMEMBER even if the pastry is cold to the touch, the filling will be piping hot and will warm the pastry through. Take care not to overheat otherwise burning can occur due to the high fat and sugar content of the filling. Check the temperature of the filling before consuming to avoid burning your mouth.

CHRISTMAS PUDDINGS AND LIQUIDS - CAUTION

Take great care when reheating these items. See Page 6.

Do not leave unattended.

Do not add extra alcohol.

BABIES' BOTTLES - CAUTION

Milk or formula MUST be shaken thoroughly before heating and again at the end and tested carefully before feeding a baby.

See page 25 for details.

WE DO NOT RECOMMEND THAT YOU USE YOUR MICROWAVE TO STERILISE BABIES' BOTTLES. If you have a special microwave steriliser we urge extreme caution, due to the low quantity of water involved. It is vital to follow the manufacturers instructions implicitly.

Reheating Charts

The times given in the charts below are a guideline only, and will vary depending on **STARTING** temperature, dish size etc.

HEATING CATEGORY

Your oven is Heating Category E and this is displayed on the front of your oven door. The information on this label will assist you in using new instructions on food packs to enable you to program the best heating time in your oven.

*1000 Watts IEC (60705) is achieved by using the Turbo Reheat pad, see page 16 for details.

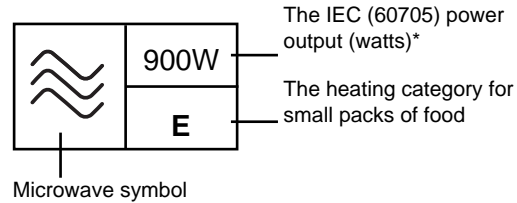

Food	Weight/ Quantity	Power Level	Time to Select (approx)	Instructions/Guidelines
BABIES BOTTLES – CAUTION				
For 7-8 fl.oz of milk from fridge temperature, remove top and teat. Heat on HIGH Power for 25-30 secs. CHECK CAREFULLY For 3 fl.oz of milk from fridge temperature, remove top and teat. Heat on HIGH Power for 10-15 secs. CHECK CAREFULLY N.B. Liquid at the top of the bottle will be much hotter than at the bottom of the bottle and must be shaken thoroughly before checking the temperature. Milk or formula must always be tested carefully before feeding a baby.				
BREAD – Precooked – Fresh – N.B. Breads reheated by Microwave will have a soft base.				
Crissants	2	HIGH	15-20 secs.	Place on microwave safe plate on turntable. Do not cover.
	4	HIGH	30-40 secs.	
Rolls	1	HIGH	15 secs.	
	4	HIGH	30-40 secs.	
CANNED BEANS, PASTA				
Baked Beans	225 g	TURBO REHEAT	1 min. 40 secs.	Place in a microwave safe bowl on turntable. Cover.
	420 g	TURBO REHEAT	3 mins. - 3 mins. 30 secs.	
Ravioli in sauce	215 g	HIGH	2 mins. 30 secs.	
	400 g	HIGH	4 mins.	
Macaroni chese	225 g	TURBO REHEAT	2 mins.	
Spaghetti Bolognese	210 g	HIGH	2 mins.	
	430 g	HIGH	4 mins.	
Spaghetti in Tomato Sauce	200 g	TURBO REHEAT	1 min. 40 secs.	
CANNED MEAT				
Chilli Con Carne	410 g	HIGH	3 mins. 30 secs.	Place in a microwave safe bowl on turntable. Cover.
Hot Dogs (drained)	415 g	HIGH	2 mins. 30 secs.	
Meat Balls	418 g	HIGH	4 mins. 30 secs.	
Minced Beef & Onion	392 g	HIGH	4 mins.	
Stewed Steak	405g	HIGH	4 mins.	
CANNED SOUPS				
Cream of Tomato	425 g	HIGH	3 mins. 30 secs. - 4 mins.	Place in a microwave safe bowl on turntable. Cover.
Minestrone	300 g	TURBO REHEAT	2 mins.	

POINTS FOR CHECKING

Always check that food is piping hot after reheating in the microwave. If unsure return to oven. Foods will still require a **STAND TIME**, especially if they cannot be stirred. The denser the food the longer the stand time.

Reheating Charts

Food	Weight/ Quantity	Power Level	Time to Select (approx)	Instructions/Guidelines
CANNED PUDDINGS				
Creamed Rice	425 g	HIGH	2 mins. - 2 mins. 30 secs.	Place in a microwave safe bowl on turntable. Cover.
	624g	HIGH	3 mins.	
Custard	425g	HIGH	2 mins.	
Sponge Pudding	300 g	HIGH	2 mins.	
CANNED VEGETABLES – Drain where appropriate				
Carrots, whole	410 g	HIGH	3 mins.	Place in a microwave safe bowl on turntable. Cover.
Mushrooms, whole	300 g	HIGH	2 mins.	
Peas, Mushy	440 g	HIGH	2 mins. - 3 mins.	
Peas, Garden	550 g	HIGH	2 mins. 30 secs.	
Potatoes, new	820 g	HIGH	5 mins.	
Sweetcorn	198 g	HIGH	1 min. 30 secs.	
	340 g	HIGH	2 mins.	
Tomatoes, whole	400 g	HIGH	3 mins.	
CHRISTMAS PUDDINGS - Overheating may cause pudding to ignite				
Slice	150 g	HIGH	30 secs.	Place in a microwave safe dish on turntable. Cover.
Small	450 g	HIGH	2 mins.	
Medium	900 g	HIGH	3 mins.	
Large	1.1 kg	HIGH	3 mins. 30 secs.	
DRINKS – COFFEE				
1 mug	235 ml	HIGH	2 mins.	Place in a microwave safe mug on turntable. Stir, before, during and after reheating.
2 mugs	470 ml	HIGH	3 mins. 30 secs.	
3 mugs	705 ml	HIGH	4 mins. 30 secs.	
4 mugs	940 ml	HIGH	6 mins.	
DRINKS – MILK				
1 mug	235 ml	MEDIUM	2 mins.	Place in a microwave safe mug on turntable. Stir, before, during and after reheating.
1 jug	600 ml	MEDIUM	4 mins. 30 secs.	
HOMEMADE MEAT DISHES				
Casserole for 2	500 g	HIGH	3 mins.	Place in a microwave safe dish on turntable. Cover.
Casserole for 4	1 kg	HIGH	10 mins.	
Bolognese Sauce	250 g	HIGH	3 mins.	
	1 kg	HIGH	8 mins.	

POINTS FOR CHECKING

Always check that food is piping hot after reheating in the microwave. If unsure return to oven. Foods will still require a STAND TIME, especially if they cannot be stirred. The denser the food the longer the stand time.

Reheating Charts

Food	Weight/ Quantity	Power Level	Time to Select (approx)	Instructions/Guidelines
PASTA				
Cooked Spaghetti	100 g	HIGH	1 min.	Place in a microwaveable safe dish on turntable. Cover.
Macaroni Cheese	225 g	HIGH	3 mins.	
	1 kg	HIGH	8 mins.	
PASTRY PRODUCTS - PRECOOKED - N.B. Pastries reheated by microwave will have a soft base.				
Beef & Onion Pie	155 g	HIGH	1-2 mins.	Place on microwaveable safe plate on turntable. Do not cover.
Chicken Pie	480 g	HIGH	4-5 mins.	
Cornish Pastie	200 g (1)	HIGH	2-3 mins.	
Quiche	400 g (1)	HIGH	3-4 mins.	
Samosas	140 g (4)	HIGH	1-2 mins.	
Steak & Kidney Pie	550 g (1)	HIGH	6-6 mins. 30 secs.	
Steak & Kidney Pie	250 g (1)	HIGH	2-2 mins. 30 secs.	
Sausage Rolls	260 g (4)	HIGH	1 min. 30 secs.-2 mins.	
Spring Roll	230 g (6)	HIGH	1-2 mins.	
Christmas Mince Pies	90 g (2)	HIGH	10-20 secs.	
PLATED MEALS - HOMEMADE - CHILLED				
Child Size	1	HIGH	3 mins.	Place on a microwave safe plate on turntable. Cover.
	2	HIGH	5 mins.	
Adult Size	1	HIGH	4-5 mins.	
	2	HIGH	5-6 mins.	
PORRIDGE				
1 portion		HIGH	1 min.	Use a large bowl on turntable. Stir during cooking.
4 portions		HIGH	5 mins.	
PUDDINGS & DESSERTS N.B. Transfer food from foil containers to a similar sized microwave safe dish				
Apple Pie	500 g	HIGH	4 mins.	Place in a microwave safe bowl on turntable. Do not cover.
Baked Apple - 1	175 g	HIGH	30 secs.-1 min.	
Bread & Butter Pudding	340 g	HIGH	2-3 mins.	
Fruit Crumble	400 g	HIGH	4 mins.	
Fruit Pie, individual	1	TURBO REHEAT	10-15 secs.	
	4	TURBO REHEAT	30-40 secs.	
Milk Pudding for 1		HIGH	50 secs.	
Milk Pudding for 4		HIGH	3 mins. 40 secs.	

POINTS FOR CHECKING

Always check that food is piping hot after reheating in the microwave. If unsure return to oven. Foods will still require a STAND TIME, especially if they cannot be stirred. The denser the food the longer the stand time.

Reheating Charts

Food	Weight/ Quantity	Power Level	Time to Select (approx)	Instructions/Guidelines
PUDDINGS AND DESSERTS N.B. Transfer food from foil containers to a similar sized microwave safe dish				
Pancakes, filled	1	HIGH	45-60 secs.	Place in a microwaveable safe dish on turntable. Cover.
	2	HIGH	1 min. 30 secs.	
Rice Pudding	500 g	HIGH	2 mins. 30 secs.	
PURCHASED CONVENIENCE FOODS - CHILLED N.B. Transfer food from foil container to a similar sized microwave safe dish. Plastic dishes designed for microwave and conventional ovens may be used with care.				
Cauliflower Cheese	450 g	HIGH	7 mins.	Place on microwaveable safe plate or rack on turntable. Do not cover.
Cottage Pie	190 g	HIGH	3-4 mins.	
	600 g	HIGH	6-8 mins.	
Hot & Spicy Wings	700 g	HIGH	6-7 mins.	
Lasagne	300 g	HIGH	5-6 mins.	
Onion Bhajjis	200 g (6)	HIGH	1-2 mins.	
Pakora & Felafel				
Vegetable Bake	454 g	HIGH	6-8 mins.	
PURCHASED CONVENIENCE FOODS - FROZEN N.B. Transfer food from foil container to a similar sized microwave safe dish. Plastic dishes designed for microwave and conventional ovens may be used with care.				
Lasagne	400 g	HIGH	5 mins. then rest for 1 min.	Place on turntable. Do not cover.
		then HIGH	4 mins.	
Salmon Crumble	300 g	HIGH	3 mins. then rest for 1 min.	
		then HIGH	3-4 mins.	
Shepherd's Pie	460 g	HIGH	6 mins. then rest for 1 min.	
		then HIGH	4-5 mins.	
SAUCES				
Custard	300 ml	HIGH	1 min. 30 secs.	Use a large bowl on turntable. Stir during cooking.
	600 ml	HIGH	3 mins.	
Savoury Sauce	300 ml	HIGH	2 mins.	
VEGETABLES				
Jacket Potato	250 g	HIGH	1 min.	Place in a microwave safe bowl on turntable. Do not cover.
Green Vegetables	100 g	HIGH	1 min. 30 secs.	
	225 g	HIGH	2 mins.	
Mashed Potato	350 g	MEDIUM	7-8 mins.	
Root Vegetables	100 g	HIGH	1 min.	
	225 g	HIGH	1 min. 30 secs.	

POINTS FOR CHECKING

Always check that food is piping hot after reheating in the microwave. If unsure return to oven. Foods will still require a STAND TIME, especially if they cannot be stirred. The denser the food the longer the stand time.

Cooking Charts

Food	Weight/ Quantity	Choice of Cooking Modes	Time Approx. (mins.)	Instructions/Guidelines
BACON – from raw				
Rashers	200 g (8)	HIGH	4-5 or 45 secs per rasher.	Place on microwave safe rack or plate on turntable and cover with kitchen towel to minimise splatter.
Steaks	210 g (4)	HIGH	4-5 mins.	Place on microwave safe rack or plate on turntable.
BEANS & PULSES – should be pre-soaked (except lentils)				
Black Eyed Beans	225 g	HIGH	10	Use 600 ml (1 pt) boiling water in a large bowl. Cover.
		then SIMMER	25-30	
Chick Peas	225 g	HIGH	10	
		then SIMMER	40	
Lentils	225 g	MEDIUM power	10-15	
Red Kidney Beans	225 g	HIGH	15	Use 600 ml (1 pt) boiling water in a large bowl. Cover. Must boil for at least 12 minutes to destroy toxic enzymes.
		then SIMMER	40	
BEEF – Joints from raw – Caution: Hot fat! Remove dish with care. For Guidelines see Meat Chapter page 39.				
Medium Rare		MEDIUM	11-14 per 450 g (1 lb)	Place on upturned saucer in flan dish or drip tray. Cover. Place on turntable. Turn joint over halfway during cooking. Drain off fat during cooking.
BEEF – Steaks from raw – Caution: Hot fat! Remove dish with care.				
Rump	350 g (2)	MEDIUM	6-8	Place on microwave safe rack or plate on turntable. Cover.
Sirloin	400 g (2)	MEDIUM	7-9	
BEEFBURGERS – Fresh from raw – Caution: Hot fat! Remove dish with care.				
	227 g (2)	MEDIUM	3-4	Place on microwave safe rack or plate on turntable. Cover.
BEEFBURGERS – Frozen from raw – Caution: Hot fat! Remove dish with care.				
	335 g (6)	MEDIUM	6	Place on microwave safe rack or plate on turntable. Cover.
CHICKEN from raw – Caution: Hot fat! Remove dish with care.				
Breasts, boneless	595 g	MEDIUM	12-14	Place on microwave safe rack or plate on turntable. Cover.
Drumsticks	900 g (8)	MEDIUM	12-14	
Quarters	1.2 kg (4)	MEDIUM	20	
Whole		MEDIUM	9-10 per 450 g (1 lb)	Place on upturned saucer breast side down in flan dish or drip tray. Cover. Place on turntable. Turn chicken over halfway.

POINTS FOR CHECKING

Always check that food is piping hot after reheating in the microwave. If unsure return to oven. Foods will still require a STAND TIME, especially if they cannot be stirred. The denser the food the longer the stand time.

Cooking Charts

Food	Weight/ Quantity	Choice of Cooking Modes	Time Approx. (mins.)	Instructions/Guidelines
EGGS – Poached.				
Water	45 ml	HIGH	50 secs.	<ul style="list-style-type: none"> Place in a small bowl and heat for 1st cooking time. Add egg (medium sized). Pierce yolk and white. Cover. Cook for 2nd cooking time. Then leave to stand for 1 min.
Egg	1	MEDIUM	30 secs.	
Water	90 ml	HIGH	1	
Eggs	2	MEDIUM	1	
Water	135 ml	HIGH	1 min. 30 secs.	
Eggs	3	MEDIUM	1 min. 30 secs.	
Water	180 ml	HIGH	2	
Eggs	4	MEDIUM	1min. 50 secs.	
EGGS – Scrambled.				
1 Egg		HIGH	30 secs.	<ul style="list-style-type: none"> Add 1 tbsp of milk for each egg used. Beat eggs, milk and knob of butter together. Cook for 1st cooking time then stir. Cook for 2nd cooking time then stand for 1 min.
		HIGH	20 secs.	
2 Eggs		HIGH	50 secs.	
		HIGH	30 secs.	
3 Eggs		HIGH	1 min. 20 secs.	
		HIGH	30 secs.	
FISH – FRESH from raw – For Guidelines see Fish Chapter page 36.				
Filletts	450 g (3)	HIGH	3-4	Place in microwave safe dish. Add 30 ml liquid. Cover.
Steaks	350 g (2)	HIGH	3-4	
Whole	280 g (1)	HIGH	3-4	
FISH – FROZEN from raw – For Guidelines see Fish Chapter page 36.				
Fish Fingers	210 g (8)	HIGH	4-5	Place on microwave safe dish. Do not cover.
Haddock Fillets	380 g (4)	HIGH	7-8	Place in microwave safe dish. Add 30 ml of liquid. Cover.
Whole	450 g (2)	HIGH	10-12	
Boil in the Bag	170 g (1)	DEFROST	4	Place bag sauce side down on a microwave safe plate. Slash top of bag with a knife.
		then stand	2	
		then MEDIUM	6	
FRUIT – Peel, slice, chop into even sized pieces. Place in shallow microwave safe dish.				
Apples – poached	450 g	HIGH	6	Add 300 ml (1/2 pt) water. Only half fill dish. Cover.
Apples – stewed	450 g	HIGH	5	Only half fill dish. Cover.
Peaches – poached	450 g	HIGH	4-5	Add 300 ml (1/2 pt) water. Only half fill dish. Cover.
Pears – poached	450 g	HIGH	5-6	
Plums – poached	450 g	HIGH	8	
Plums – stewed	450 g	HIGH	8-10	Add 30 ml (2 tbsp) of water. Only half fill dish. Cover.
Rhubarb – stewed	450 g	HIGH	5	Only half fill dish. Cover.

POINTS FOR CHECKING

Always check that food is piping hot after reheating in the microwave. If unsure return to oven. Foods will still require a STAND TIME, especially if they cannot be stirred. The denser the food the longer the stand time.

Cooking Charts

Food	Weight/ Quantity	Choice of Cooking Modes	Time Approx. (mins.)	Instructions/Guidelines
LAMB – from raw – CAUTION: Hot Fat! Remove dish with care. For Guidelines see Meat Chapter page 39.				
Chops, cutlets	425 g (4)	MEDIUM	6-7	Place in microwave safe dish or rack on turntable. Cover.
Chops, loin	600 g (4)	MEDIUM	7-8	
Joints		MEDIUM	12-13 per 450 g (1 lb)	Place on upturned saucer in microwave safe dish or drip tray. Cover. Place dish on turntable. Turn joint over halfway during cooking. Drain off fat during cooking.
PASTA – Place in a large 2 litre (4 pint) microwave safe bowl.				
Twists	225 g	HIGH	8-10	Use 1 litre (1¾ pt) boiling water. Add 15 ml oil. Cover. Stir halfway.
Macaroni	225 g	HIGH	10-12	
Spaghetti	225 g	HIGH	8	
Lasagne	225 g	HIGH	6-8	
Tortellini	225 g	HIGH	12	
Tagliatelli	225 g	HIGH	8-9	
Spaghetti (Quick Cook)	225 g	HIGH	5-7	
Pasta Shapes (Quick Cook)	225 g	HIGH	6-7	
PASTRY – UNCOOKED				
Shortcrust Flan Case	23 cm (9")	HIGH	3-4	Prick base of pastry, chill well. Lay piece of kitchen towel in base. Place on turntable.
PIZZA – FRESH CHILLED – N.B. Remove all packaging. Pizzas will have a soft base.				
Thin & Crispy	400 g	HIGH	4-5	Place on heatproof plate on turntable. Do not cover.
Deep Pan	475 g	HIGH	4-6	
PORK – from raw – CAUTION: Hot Fat! Remove dish with care. For Guidelines see Meat Chapter page 39.				
Chops	360 g (2)	MEDIUM	5-6	Place in microwave safe dish on rack on turntable. Cover.
Joints		MEDIUM	13-15 per 450 g (1 lb)	Place on upturned saucer in microwave safe dish or drip tray on turntable. Turn joint over halfway during cooking. Drain off fat during cooking.
PORRIDGE – N.B. Use a large bowl.				
1 serving	½ cup oats	HIGH	2-2½	Add 1 cup of water or milk. Stir halfway.
2 servings	1 cup oats	HIGH	4-5	Add 2 cups of water or milk. Stir halfway.
3 servings	2 cups oats	HIGH	8-9	Add 4 cups of water or milk. Stir halfway.
RICE – Place in a large microwave safe bowl.				
Basmati	250 g	MEDIUM	10-12	Use 600 ml (1 pt) boiling water. Cover.
Easycok White	250 g	HIGH	12-13	

POINTS FOR CHECKING

Always check that food is piping hot after reheating in the microwave. If unsure return to oven. Foods will still require a STAND TIME, especially if they cannot be stirred. The denser the food the longer the stand time.

Cooking Charts

Food	Weight/ Quantity	Choice of Cooking Modes	Time Approx. (mins.)	Instructions/Guidelines
RICE – Place in a large microwave safe bowl.				
Easycook Brown	250 g	HIGH	15-17	Use 600 ml (1 pt) boiling water. Cover.
Long Grain White	250 g	MEDIUM	14	
Long Grain Brown	250 g	MEDIUM	20	
Wild Rice & Brown Rice Mix	250 g	MEDIUM	18	
MILK PUDDING – Place in a large microwave safe bowl.				
Flaked Rice	50 g	SIMMER power	20	Add 600 ml (1 pt) milk. 30 ml sugar.
Pudding Rice	50 g	HIGH then SIMMER	5 30	Add 450 ml (¾ pt) milk. 30 ml sugar.
Tapioca	50 g	SIMMER	30-35	Add 600 ml (1 pt) milk. 30 ml sugar.
SAUSAGES from raw – CAUTION: Hot Fat! Remove dish with care.				
Chipolatas	227 g (8)	HIGH	3-4	Place on microwave safe plate or rack on turntable. Cover.
Thick	454 g (8)	HIGH	4-5	
FRESH VEGETABLES – Place in shallow microwave safe dish.				
Asparagus	450 g	HIGH	6-8	Add 90 ml (6 tbsp) water. Cover.
Aubergine	450 g	HIGH	7	
Broad Beans	450 g	HIGH	6	
Runner Beans	450 g	HIGH	7	
French Beans	450 g	HIGH	7-8	
Beetroot	450 g	MEDIUM	12	
Broccoli	450 g	HIGH	8	
Brussel Sprouts	450 g	HIGH	8-9	
Cabbage – sliced	450 g	HIGH	7-9	
Carrots	450 g	HIGH	7-9	
Cauliflower – florets	450 g	HIGH	9	
Celery	450 g	HIGH	8-9	
Corn on the Cob	450 g	HIGH	6-7	
Courgettes	450 g	HIGH	5	
Leeks	450 g	HIGH	7-9	
Mange Tout	450 g	HIGH	4-5	
Marrow – cubed	450 g	HIGH	4-5	
Mushrooms	450 g	HIGH	5	
Parsnips – sliced	450 g	HIGH	6-7	

POINTS FOR CHECKING

Always check that food is piping hot after reheating in the microwave. If unsure return to oven. Foods will still require a STAND TIME, especially if they cannot be stirred. The denser the food the longer the stand time.

Cooking Charts

Food	Weight/ Quantity	Choice of Cooking Modes	Time Approx. (mins.)	Instructions/Guidelines
FRESH VEGETABLES – Place in shallow microwave safe dish.				
Peas	450 g	HIGH	4-6	Add 90 ml (6 tbsp) water. Cover.
Potatoes – boiled	450 g	HIGH	6-7	
Potatoes – par-boiled	450 g	HIGH	4-5	
Potatoes – new whole	450 g	HIGH	6-7	
Potatoes – to mash	450 g	HIGH	8	
Potatoes – jacket (200 g / 7 oz)	1	HIGH	4 mins. 30 secs.	Wash and prick skins several times. Place directly on turntable. After cooking stand for 5 mins wrapped in foil. Or use Auto Program Jacket Potato.
	2	HIGH	7	
	4	HIGH	12	
Potatoes – jacket (250 g / 9 oz)	1	HIGH	5 mins. 30 secs.	
	2	HIGH	9 mins. 30 secs.	
	4	HIGH	15	
Spinach	450 g	HIGH	7	Add 90 ml (6 tbsp) water. Cover.
Spring Greens	450 g	HIGH	7	
Swede – cubed	450 g	HIGH	7-8	
Turnip	450 g	HIGH	11-12	
FROZEN VEGETABLES – Place in shallow microwave safe dish.				
Asparagus	450 g	HIGH	7-8	Add 30 ml (2 tbsp) water. Cover.
Beans – broad	450 g	HIGH	8	
Beans – green	450 g	HIGH	8-9	
Broccoli	450 g	HIGH	9	
Brussel Sprouts	450 g	HIGH	9-10	
Cabbage – shredded	450 g	HIGH	5-6	
Carrots	450 g	HIGH	8-9	
Cauliflower	450 g	HIGH	10	
Mange Tout	450 g	HIGH	7-8	
Mixed Vegetables	450 g	HIGH	7	
Peas	450 g	HIGH	6-7	
Spinach – nuggets	450 g	HIGH	8-9	
Swede – diced	450 g	HIGH	10	
Sweetcorn	450 g	HIGH	7	

POINTS FOR CHECKING

Always check that food is piping hot after reheating in the microwave. If unsure return to oven. Foods will still require a STAND TIME, especially if they cannot be stirred. The denser the food the longer the stand time.

Increasing and Decreasing Recipes

INCREASING RECIPES

- **To increase a recipe from 4 to 6 servings**, increase each ingredient listed by half. To double the quantity, simply double every ingredient listed.
- Do not forget that large quantities will require a larger dish. Make sure that it is deep enough to prevent the recipe from boiling over during cooking.
- Cover as directed in the recipe. Stir or rearrange foods as recommended.
- Increase the stand times by 5 mins. per lb/450 g.
- Always check the recipe during cooking.
- When increasing the ingredients to 6 servings, add an extra one third of the original cooking time, ie. 30 mins. on MEDIUM power

for 4 servings will become 40 mins. on MEDIUM power for 6 servings.

- **When doubling a recipe from 4 to 8** add on half the original cooking time, ie. 30 mins. on MEDIUM power for 4 servings will become 45 mins. on MEDIUM power for 8 servings.

DECREASING RECIPES

- To decrease a recipe from 4 servings to 2 servings, halve the ingredients listed.
- Choose a dish that is proportionally smaller than the one recommended in the recipe, however make sure it is deep enough to stop food boiling over.
- Allow half to two-thirds of the original cooking time, ie. 30 mins. on MEDIUM power for 4 servings will become 15-20 mins. on MEDIUM power for 2 servings.

Using Recipes from Other Books

The best way to convert a family favourite dish is to find a similar recipe in a cookery book to give you a guide to the correct method and timings to use.

Many cookbooks refer to 650 W ovens, however since 1990 oven output powers have been set by a new standard (IEC). When using

other cookbooks, the 900 W output power of your oven must be allowed for. Use the same power level suggested e.g. HIGH or MEDIUM and select the same cooking time suggested, however CHECK the progress of the food during cooking and adjust the time if necessary.

Cooking for One

- For one serving quarter ALL ingredients listed.
- Choose a dish that is proportionally smaller than the one recommended in the recipe.
- Use the same cooking power recommended in the original recipe.
- Start by cooking for one quarter of the recommended cooking time, although extra time in most cases will be required.

- Always check the food during cooking.
- There is not a great saving for reduced quantities of soups, casseroles, stews and rice, as a minimum time is required to tenderise meats and blend flavours.
- When cooking for one it often makes sense to cook for two and plate up both meals. Freeze one meal for a later date.

Soups and Starters

Ingredients

8 field mushrooms, approx. 150 g
(5 oz) total weight
50 g (2 oz) butter
60 ml (4 tbsp) chopped mixed herbs
1 garlic clove, crushed
seasoning

Ingredients

8 rashers streaky bacon, stretched and halved
450 g (1 lb) minced pork
60 ml (4 tbsp) breadcrumbs
5 ml (1 tsp) sage
1 onion, finely chopped
15 ml (1 tbsp) lemon juice
30 ml (2 tbsp) parsley, chopped
15 ml (1 tbsp) capers
salt and pepper to taste

Ingredients

25 g (1 oz) butter
15 ml (1 tbsp) olive oil
1 onion, finely chopped
350 g (12 oz) potatoes, diced
500 g (1 lb 2 oz) broccoli, cut into florets
850 ml (1½ pts) vegetable stock
3 ml (½ tsp) grated nutmeg
150 ml (¼ pt) semi skimmed milk
100 g (4 oz) stilton cheese, cubed
Salt and pepper

Garlic Mushrooms with Herbs

Serves 4

Dish: large flan dish

1. Arrange the mushrooms in a large flan dish. Dot with butter and sprinkle with the herbs and garlic.
2. Cover and cook on HIGH power for 3-4 mins. or until mushrooms are just tender. Season and serve.

Coarse Pork Pâtés

Serves 4

Dish: 4 ramekin dishes 8 cm (3") diameter

1. Line each ramekin with 4 half rashers of bacon.
2. Mix all ingredients together and press into ramekins.
3. Cook 4 ramekins together on MEDIUM power for 12-14 mins. or until cooked through. Pour off excess liquid, and serve hot or cold with crusty French bread.

Broccoli and Stilton Soup

Serves 4

Dish: large bowl

1. Place the butter, oil and onion in a large bowl. Cover and cook on HIGH power for 3 mins. or until soft.
2. Add the potatoes, cover and cook on HIGH power for 3-4 mins. or until softened.
3. Add the broccoli, hot vegetable stock and nutmeg. Cover and cook on HIGH power for 15-20 mins. or until the broccoli is cooked.
4. Allow to cool and then blend in a food processor until smooth.
5. Stir in the milk and stilton cheese. Season to taste. Reheat the soup on HIGH power for 4-5 mins. or until hot and smooth. Stir frequently.

Fish

Fish cooks very well by microwave as it stays moist and the lingering fish smells left in conventional ovens are avoided.

WHEN IS FISH COOKED?

Fish is cooked when it flakes easily and becomes opaque.



ARRANGING

Thin fillets of fish i.e. plaice, should be rolled up prior to cooking to avoid overcooking on the thinner outside edge and tail.

Fish steaks should be arranged in a circle, thicker part to the outside. Cover with cling film or lid.

Ingredients

4 trout, 350 g (12 oz) each

Stuffing:

1 bunch spring onions, finely chopped
100 g (4 oz) button mushrooms, finely sliced
grated rind and juice of 1 orange
2½ cm (1") cube fresh ginger, peeled and grated
dash of Soy sauce

juice of 1 orange
juice of 1 lime
black pepper
25 g (1 oz) butter

For fish with a strong odour, eliminate the smell after cooking by placing 600 ml (1 pt) of boiling water and 1 sliced lemon in a large bowl, cook on SIMMER for 20 mins. Wipe out oven with a dry cloth.



LIQUID

Fresh fish should always be sprinkled with 30 ml (2 tbsp) of lemon juice, white wine or water.

When cooking **Frozen** fish, add liquid as above for even cooking.

Do not sprinkle salt onto fish before cooking as this may make the fish dry.

WHOLE FISH

If cooking 2 whole fish together, they should be arranged head to tail for even cooking.

Large whole fish must have the tail and head shielded halfway through cooking with smooth pieces of tin foil secured with cocktail sticks.



NOISE

During cooking, popping sounds may be heard. This is due to moisture trapped between the flesh, particularly with oily fish such as salmon and mackerel. This can be minimised when cooking if the skin and flesh is pierced several times with a cocktail stick.

Stuffed Citrus Trout

Serves 4

Dish: large shallow dish

1. Wash, cut the heads off the fish and pat dry. Pierce the flesh all over. Fill the fish cavities with the combined stuffing ingredients and arrange the fish in a shallow dish.
2. Pour over the orange and lime juice. Season. Marinade for one hour.
3. Dot with butter, cover and cook on HIGH power for 10-12 mins. or until cooked. Allow to stand for 5 mins. before serving.

Ingredients

100 g (4 oz) broccoli
100 g (4 oz) cauliflower
1 medium red pepper, diced
198 g (7 oz) can salmon, drained
25 g (1 oz) butter
30 ml (2 tbsp) plain flour
300 ml (½ pt) milk
50 g (2 oz) grated tasty cheese
150 ml (¼ pt) cream cheese (optional)
salt and pepper to taste
15 g (½ oz) butter
75 g (3 oz) fresh white breadcrumbs
15 ml (1 tbsp) chopped fresh parsley
pinch paprika

Ingredients

450 g (1 lb) smoked haddock cut into
4 portions
300 ml (½ pt) milk
knob of butter

Ingredients

450 g (1 lb) smoked haddock
30 ml (2 tbsp) lemon juice
15 ml (1 tbsp) oil
1 large onion, sliced
600 g (1¼ lb) cooked jacket potatoes, sliced
(see page 33)
40 g (1½ oz) butter
40 g (1½ oz) flour
3 ml (½ tsp) mustard
600 ml (1 pt) milk
salt and pepper
100 g (4 oz) Red Leicester cheese
75 g (3 oz) wholemeal breadcrumbs

Salmon and Vegetable Mornay

Serves 4

Dish: 20 x 25 cm (8" x 10") dish

1. Break broccoli and cauliflower into florets, add red pepper and 2 tbsp water. Cover and cook on HIGH power for 5 mins. or until soft. Drain.
2. Flake salmon and mix with vegetables.
3. Melt butter in a jug on HIGH power for approx. 20-30 secs. Stir in flour then milk. Cook on HIGH power for 2 mins. or until mixture boils and thickens; stir halfway. Stir in cheese, cream and seasoning. Pour cheese sauce over vegetables and salmon.
4. Melt extra butter in a small bowl on HIGH power for approx. 15-20 secs. Stir in breadcrumbs, parsley and paprika. Sprinkle over vegetable mixture.
5. Cook on MEDIUM power for 7-8 mins. or until piping hot.

Poached Smoked Haddock

Serves 4

Dish: casserole dish

1. Place haddock in single layer in casserole dish and cover with milk and butter. Cover and cook on HIGH power for 5-6 mins. Serve on its own or with poached eggs on top.

Family Fish Pie

Serves 4

Dish: large casserole

1. Arrange fish in a shallow dish. Add lemon juice, cover and cook on HIGH power for 3 mins. or until it flakes easily.
2. Place onion and oil in a bowl. Cover and cook on HIGH power for 3 mins. or until the onion is soft.
3. Melt the butter on HIGH power for 30 secs. Stir in the flour and mustard and cook for a further 15 secs. Add milk and seasoning, gradually stirring to a smooth paste. Cook on HIGH power for 5 mins. or until the sauce is thick and bubbling. Stir twice during cooking. Add 75 g (3 oz) of grated cheese to the sauce and stir well.
4. Flake the fish and arrange in the serving dish. Add onions and place the sliced potatoes on top.
5. Pour over the cheese sauce. Sprinkle with breadcrumbs and remaining cheese.
6. Cook on MEDIUM power for 8-10 mins. or until the mixture has been completely reheated.

Ingredients

25 g (1 oz) butter
 2 onions, peeled and quartered
 1 clove of garlic, crushed
 2 courgettes, sliced
 1 yellow pepper, sliced
 3 ml (½ tsp) cumin
 3 ml (½ tsp) paprika
 15 ml (1 tbsp) tomato puree
 400 g (14 oz) can tomatoes
 8 plaice fillets
 15 ml (1 tbsp) lemon juice

Ingredients

1 red pepper, cut into chunks
 350 g (12 oz) cod or huss, cubed
 8 button mushrooms
 1 small sweetcorn, cooked and cut into slices

Marinade:

½ small onion, grated
 60 ml (4 tbsp) olive oil
 60 ml (4 tbsp) lemon juice
 2 cloves of garlic, crushed
 30 ml (2 tbsp) parsley, chopped

Ingredients

15 ml (1 tbsp) oil
 1 onion, finely chopped
 175 g (6 oz) okra, topped and tailed
 1 green pepper, deseeded and sliced
 30 ml (2 tbsp) Balti curry paste
 400 g (14 oz) can chopped tomatoes
 75 ml (5 tbsp) water
 350 g (12 oz) cod fillet, cubed
 12 large king prawns, cooked

Plaice Provencal

Serves 4

Dish: large shallow rectangular dish

1. Place the butter, onions and garlic in a large bowl. Cover and cook on HIGH power for 2 mins. or until softened.
2. Add the courgettes and yellow pepper. Cover and cook on HIGH power for 2 mins. or until softened. Add the spices, puree and tomatoes. Cover and cook on HIGH power for 4 mins. or until piping hot. Pour into serving dish.
3. Roll each fillet and arrange on top of the sauce. Sprinkle with lemon juice. Cook covered on HIGH power for 7-8 mins. or until the fish is cooked. Garnish with parsley and serve with French bread.

Fish Kebabs

Serves 4

Dish: shallow dish + wooden skewers

1. Place pieces of red pepper in a bowl with 30 ml (2 tbsp) of water. Cover and cook on HIGH power for 1-2 mins, or until slightly softened.
2. Prepare 4 kebabs by threading fish and vegetables alternately. Place in a shallow dish.
3. Mix together the marinade ingredients. Pour over the kebabs, cover and leave to marinate in the fridge for at least 2 hours.
4. Place the kebabs in a shallow dish. Cover and cook on HIGH power for 6-7 mins. or until cooked. Rearrange the kebabs halfway through cooking. Fish should be white and flake easily when cooked. Serve on a bed of wild rice.

Fish Balti

Serves 4

Dish: 3 litre (6 pt) casserole dish

1. Place the oil and onion in a large bowl. Cover and cook on HIGH power for 3 mins. or until the onion is softened.
2. Add the okra and pepper and cook on HIGH power for 3 mins. or until softened.
3. Stir in the curry paste, tomatoes and the water. Cover and cook on HIGH power for 5 mins. or until boiling.
4. Add the cod and cook on HIGH power for 3 mins. Stir in the prawns and cook on HIGH power for a further 2 mins. or until the fish is cooked.

Meat and Poultry

Guidelines

DEFROSTED JOINTS

If the meat has previously been frozen, ensure it is properly thawed before cooking by microwave. Defrosted joints of meat must be allowed to **STAND** for a **minimum of 60 mins.** before cooking to ensure the centre is fully defrosted.

FAT

Large amounts of fat absorb microwave energy and can cause the meat next to it to overcook. Always choose joints that aren't excessively fatty.

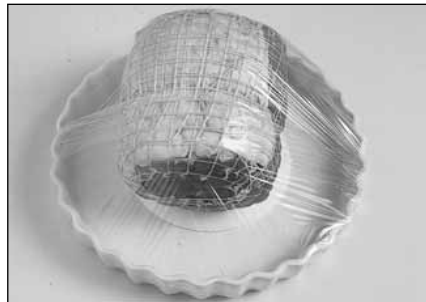

How to roast a joint by microwave

To roast basic joints of meat place the joint onto the rack of a microwave roasting set and cover with a dome lid. Alternatively use a large, shallow dish and place the joint on an upturned saucer and cover with cling film.

STANDING TIME

Meat and poultry require a **minimum of 15 mins. STANDING TIME** wrapped in aluminium foil after cooking by microwave. Roast meat is always easier to carve after **STANDING** and the meat will continue to cook during the **STAND TIME**.

BONE

Bone tips on legs of lamb and crown roasts may need shielding when cooked by microwave, to prevent overcooking.



How to cook small cuts of meat by microwave

Some cuts of meat can be cooked successfully by microwave although due to their short cooking times and no heat source, they will not crisp and brown.

They should always be cooked on a microwave rack to lift them out of their juices.

TURNING

Joints and poultry **should be turned over** halfway through cooking.

SHIELDING

Large joints may need shielding with pieces of smooth aluminium foil after half the cooking time to avoid overcooking on the outside edges. Turkeys and large chickens should have their breast meat, legs and wings protected. Secure foil with cocktail sticks and **do not** allow foil to touch the walls of the oven.

ROASTING BAGS

Roasting bags are useful when split up one side to tent a joint for roasting by power and time.

Do not use the metal twists supplied.

TIPS

Braised and stewed meat cooked in a microwave has a slightly firm texture and therefore it is essential to purchase good quality meats.

When cooking a casserole, place a saucer or small upturned plate over the meat to keep it submerged in the juices.

Crispy Bacon - place on a microwave safe rack (optional extra obtainable from cookware shops). Cover with a plain piece of kitchen towel to minimise splatter. Cook on **HIGH** power for approx. 45 secs. per rasher, or until desired crispness is achieved.

Ingredients

1 onion, diced
 1 clove of garlic, crushed
 1 green pepper, diced
 30 ml (2 tbsp) oil
 100 g (4 oz) mushrooms, sliced
 225 g (8 oz) lean minced beef
 1 glass of red wine
 15 ml (1 tbsp) mixed herbs
 100 g (4 oz) garlic sausage or bacon, diced
 396 g (14 oz) can chopped tomatoes
 30 ml (2 tbsp) tomato puree
 salt and pepper

Ingredients

3-4 cloves garlic
 1 cm ($\frac{1}{4}$ " piece fresh ginger, grated
 50 g (2 oz) ground almonds
 3x15 ml (3 tbsp) water
 3 whole cardamon pods
 2 cloves
 2.5 cm (1") stick of cinnamon
 1 onion chopped
 2x15 ml (2 tbsp) oil
 450 g (1 lb) boned lamb, trimmed and cut into cubes
 1x5 ml (1 tsp) ground coriander
 1x5 ml (1 tsp) ground cumin
 1.5 ml ($\frac{1}{4}$ tsp) garam masala
 1.5 ml ($\frac{1}{4}$ tsp) cayenne pepper
 150 ml ($\frac{1}{4}$ pt) single cream
 salt and pepper

Ingredients

675 g (1 $\frac{1}{2}$ lb) shoulder of lamb, cubed
 1 large onion, chopped
 450 ml ($\frac{3}{4}$ pt) hot chicken stock
 15 ml (1 tbsp) dried rosemary
 450 g (1 lb) potatoes, peeled and coarsely chopped
 salt and pepper
 10 ml (2 tsp) cornflour
 50 g (2 oz) tasty cheese grated

Bolognese Sauce

Serves 4

Dish: 1.5 litre (3 pt) casserole dish

1. Mix onion, garlic, pepper and oil in a bowl. Cook on HIGH power for 2 mins. or until the onion is soft.
2. Stir in all the other ingredients. Cover and cook on HIGH power for 10 mins. then MEDIUM power for 15-20 mins. or until vegetables are soft.

Lamb in a Spicy Cream and Almond Sauce

Serves 4

Dish: large casserole dish

1. Mix together the garlic, ginger, almonds and water to make a thick paste.
2. Place the cardamon pods, cloves, cinnamon, onion and oil in the casserole dish cook on HIGH power for 2 mins.
3. Add the lamb and cook for 5 mins. on HIGH power or until light brown in colour. Stir halfway.
4. Stir in the rest of the spices, the almond mixture, cream, salt and pepper. Cover and cook on SIMMER power for 40-50 mins. or until the meat is tender. Stir the casserole 2-3 times during the cooking time.
5. Remove the whole cardamon pods, cloves and cinnamon before serving with rice or other vegetables.

Lamb Casserole

Serves 4

Dish: 3 litre (6 pt) casserole dish

1. Place all the ingredients except cheese and cornflour into casserole dish. Place plate on top of meat to prevent meat drying out during cooking.
2. Cover and cook on HIGH power for 10 mins., then SIMMER power for 40 mins. or until meat is tender.
3. Mix cornflour with a little water and stir into casserole to thicken gravy.
4. Sprinkle with cheese and reheat on HIGH power for 2 mins. or until cheese melts.

Ingredients

500 g (1 lb 2 oz) braising steak, cubed
 2 large onions, sliced thinly
 1 clove garlic, crushed
 30 ml (2 tbsp) seasoned flour
 15 ml (1 tbsp) brown sugar
 300 ml (1/2 pt) hot beef stock
 300 ml (1/2 pt) light ale
 15 ml (1 tbsp) wine vinegar
 5 ml (1 tsp) mixed herbs
 2 bay leaves

Ingredients**Filling:**

350 g (12 oz) braising steak, cubed
 100 g (4 oz) kidney, cubed
 30 ml (2 tbsp) seasoned flour
 1 onion, chopped
 600 ml (1 pt) hot beef stock

Pudding:

175 g (6 oz) self-raising flour
 pinch salt
 75 g (3 oz) suet
 cold water to mix
 15 ml (1 tbsp) cornflour

Ingredients

100 g (4 oz) creamed coconut
 90 ml (6 tbsp) crunchy peanut butter
 45 ml (3 tbsp) lemon juice
 30 ml (2 tbsp) soy sauce
 large pinch of chilli powder
 4 chicken breast fillets, skinned
 30 ml (2 tbsp) vegetable oil
 2 garlic cloves, crushed
 5 ml (1 tsp) ground turmeric
 5 ml (1 tsp) five-spice powder
 5 ml (1 tsp) coriander seeds
 5 ml (1 tsp) cumin seeds

Belgian Beef Casserole

Serves 4

Dish: large casserole with lid

1. Combine all the casserole ingredients in dish. Cover with lid and cook on HIGH power for 10 mins. Stir then use SIMMER power for 90 mins. or until meat is tender, stir every 30 mins. Remove bay leaves.

Steak and Kidney Pudding

Serves 4

Dish: 1.5 litre (3 pt) casserole + 1.2 litre (2 pt) pudding basin

1. Combine all filling ingredients in casserole. Place upturned plate on top of meat, cover and cook on HIGH power for 10 mins., then SIMMER power for 60 mins., or until meat is tender. Remove plate.
2. Mix flour, salt and suet together. Mix to a firm dough with cold water.
3. Roll out 3/4 of pastry to line basin.
4. Remove meat with a slotted spoon and fill basin. Mix cornflour with water and stir into the gravy. Cook on HIGH power for 2 mins., stirring once, or until gravy has thickened. Pour 60 ml (4 tbsp) of gravy over the meat and reserve the rest for serving. Roll the remaining pastry to form a lid, moisten the edges and seal over the top of meat.
5. Cook on MEDIUM power for 10-12 mins. or until pastry looks dry.

Chicken Satay

Serves 4

Dish: 4-8 wooden skewers + large shallow dish

1. For the serving sauce: Crumble 50 g (2 oz) of creamed coconut into a large jug. Add the peanut butter, 15 ml (1 tbsp) of the lemon juice, 15 ml (1 tbsp) of the soy sauce, the chilli powder and 300 ml (1/2 pt) water. Cook on HIGH power for 5-6 mins. or until the sauce boils and thickens, stirring frequently. Turn into a serving bowl.
2. Cut the chicken into small chunks and place in a bowl.
3. Put the remaining creamed coconut, lemon juice and soy sauce into a blender or food processor. Add the remaining ingredients and blend until smooth.
4. Pour over the chicken. Cover and marinate in the fridge for 2-3 hours or overnight.
5. Thread the chicken onto wooden skewers. Place on a shallow dish, cover with any remaining marinade and cook covered on HIGH power for 7-8 mins. or until cooked, turn and baste frequently. Serve hot with the sauce for dipping.

Ingredients

15 ml (1 tbsp) sunflower oil
 450 g (1 lb) pork, cubed
 1 onion, sliced
 1 clove garlic, crushed
 1 green pepper, deseeded and cut into strips
 15 ml (1 tbsp) paprika
 3 ml ($\frac{1}{2}$ tsp) ground cumin
 396 g (14 oz) can chopped tomatoes
 15 ml (1 tbsp) tomato puree
 150 ml ($\frac{1}{4}$ pt) hot pork or chicken stock
 175 g (6 oz) button mushrooms
 black pepper
 10 ml (2 tsps) cornflour
 30 ml (2 tbsp) crème fraîche

Ingredients

25 g (1 oz) butter
 2 medium onions, sliced
 2 sticks celery, trimmed and chopped
 100 g (4 oz) mushrooms, sliced
 4 chicken quarters, skinned
 300 ml ($\frac{1}{2}$ pt) hot chicken stock
 396 g (14 oz) can tomatoes
 salt and pepper
 30 ml (2 tbsp) cornflour

Ingredients**Sauce**

15 ml (1 tbsp) cornflour
 15 ml (1 tbsp) caster sugar
 15 ml (1 tbsp) white wine vinegar
 15 ml (1 tbsp) orange juice
 15 ml (1 tbsp) tomato sauce
 15 ml (1 tbsp) sherry
 juice from pineapple
 seasoning to taste

450 g (1 lb) pork fillet, diced and trimmed
 $\frac{1}{2}$ green pepper sliced
 225 g (8 oz) can pineapple chunks, drained
 (reserve juice)

Paprika Pork Casserole

Serves 4

Dish: large casserole

1. Place all the ingredients except the cornflour and crème fraîche in a large bowl. Cover and cook on HIGH power for 10 mins.
2. Stir the casserole, cover and cook on SIMMER power for 50 mins., or until the meat is cooked. Stir once during cooking.
3. Blend the cornflour with a little water and stir into the casserole. Cover and cook for a further 5 mins. on SIMMER power or until thickened.
4. Swirl in the crème fraîche and serve immediately.

Chicken Casserole

Serves 4

Dish: 3 litre (6 pt) casserole

1. Place vegetables and butter in dish. Cover and cook on HIGH power for 2-3 mins. or until soft.
2. Place chicken on top of vegetables, cover with stock and tomatoes and add salt and pepper to taste.
3. Cover and cook on HIGH power for 5 mins. then SIMMER power for 35-40 mins. or until well cooked through.
4. Mix cornflour with a little water. Remove chicken from casserole, skim off excess fat and stir in cornflour paste. Cook on HIGH power for 2 mins. Serve chicken with sauce poured over.

N.B.

If diced boneless breast is used in place of the quarters, reduce 2nd cooking time to 15-20 mins. or until well cooked through.

Sweet and Sour Pork

Serves 4

Dish: 20 cm (8") casserole

1. Mix all sauce ingredients together.
2. Layer pork, pepper and pineapple in casserole, pour over sauce.
3. Cover and cook on HIGH power for 5 mins. then LOW power for 10-15 mins. or until meat is tender. Stir halfway through cooking time.

Pasta and Rice

Ingredients

275 g (10 oz) spaghetti
400 g (14 oz) new potatoes, cubed
225 g (8 oz) green beans, halved
120 g (4½ oz) tub fresh pesto
olive oil, for drizzling
salt and fresh ground black pepper

Ingredients

225 g (8 oz) mixed dried pasta i.e. tagliatelle, twists, shells
1½ litre (3 pt) boiling water
15 ml (1 tbsp) oil
3 ml (½ tsp) salt
25 g (1 oz) butter
100 g (4 oz) mushrooms, peeled and sliced
198 g (7 oz) can tuna, drained

Sauce:

40 g (1½ oz) butter
40 g (1½ oz) flour
600 ml (1 pt) milk
30 ml (2 tbsp) Dry Vermouth (optional)
salt & pepper
100 g (4 oz) prawns to garnish

Ingredients

175 g (6 oz) easycook brown rice
450 ml (¾ pt) hot chicken stock
450 g (1 lb) smoked haddock
30 ml (2 tbsp) lemon juice
1 medium onion, chopped
15 ml (1 tbsp) oil
150 ml (¼ pt) sour cream
15 ml (1 tbsp) curry paste
100 g (4 oz) frozen peas
30 ml (2 tbsp) parsley, chopped
2 hardboiled eggs, chopped

Pesto Spaghetti

Serves 4

Dish: large casserole

1. Place spaghetti in a large bowl, add 1 litre (1¾ pt) of boiling water, cover and cook on HIGH power for 8-9 mins. or until cooked. Drain and keep warm.
2. Place the potatoes in a bowl with 90 ml (6 tbsp) of water, and cook on HIGH power for 5-6 mins., add the green beans and cook for a further 3-4 mins. or until tender.
3. Combine the spaghetti and vegetables together with 4 tbsps of the liquid, from the potatoes and beans.
4. Stir in the fresh pesto, season to taste and serve drizzled with a little olive oil.

Tuna Pasta Bake

Serves 4

Dish: 3 litre (6 pt) casserole dish

1. Cook pasta in water with oil and salt covered on HIGH power for 10-12 mins. or until soft. Leave to stand for 2-3 mins. Drain.
2. Melt butter in small dish on HIGH power for approx. 45 secs. Add mushrooms and cook on HIGH power for 3-4 mins. or until soft.
3. To make sauce, melt butter on HIGH power for 30-40 secs. Stir in flour to make a roux. Gradually whisk in milk until well combined. Cook on HIGH power for 3-5 mins. or until smooth and glossy. Stir halfway through cooking. Add Vermouth and season.
4. Combine pasta, tuna and mushrooms in dish. Pour sauce over and stir to mix thoroughly. Garnish with prawns.

Kedgerree

Serves 2

Dish: large casserole

1. Place the rice and chicken stock in casserole, cover and cook on HIGH power for 15-17 mins. or until tender.
2. Place the fish in a shallow dish, sprinkle with lemon juice, cover and cook on HIGH power for 5-6 mins. or until cooked. Skin and flake.
3. Place onion and oil in a small dish, cover and cook on HIGH power for 3-4 mins. or until softened.
4. Combine sour cream with curry paste. Mix into rice then stir in flaked fish, onion, peas, parsley, eggs and seasoning. Cover and cook on HIGH power for 5 mins. until piping hot.

Ingredients

30 ml (2 tbsp) olive oil
 1 onion, finely chopped
 2 cm ($\frac{3}{4}$ ") fresh root ginger, peeled and chopped
 10 ml (2 tsp) cumin seeds
 3 ml ($\frac{1}{2}$ tsp) turmeric
 1 cinnamon stick, broken in half
 4 boneless chicken breasts, cubed
 275 g (10 oz) basmati rice
 1 litre ($1\frac{3}{4}$ pt) hot chicken stock
 75 g (3 oz) ready to eat dried apricots, chopped
 50 g (2 oz) sultanas
 salt and pepper

Ingredients

1 aubergine, cubed
 salt
 350 g (12 oz) tagliatelle, fresh
 1 onion
 1 clove garlic crushed
 15 ml (1 tbsp) olive oil
 397 g (14 oz) tin of chopped tomatoes
 5 ml (1 tsp) basil
 15 ml (1 tbsp) tomato puree
 15 g ($\frac{1}{2}$ oz) butter
 salt and pepper
 8-10 black olives, stoned
 100 g (4 oz) mozzarella, diced
 30 ml (2 tbsp) parmesan cheese, grated

Ingredients

1 large onion, sliced
 225 g (8 oz) courgettes, thickly sliced
 225 g (8 oz) green beans, chopped
 225 g (8 oz) carrots, thickly sliced
 1 small cauliflower, broken into florets
 396 g (14 oz) can chick peas, drained
 5 ml (1 tsp) tumeric
 3 ml ($\frac{1}{2}$ tsp) cinnamon
 salt
 1 clove garlic, crushed
 300 ml ($\frac{1}{2}$ pt) hot vegetable stock
 350 g (12 oz) couscous

Fruity Chicken Risotto

Serves 4

Dish: 3 litre (6 pt) casserole

1. Place the oil, onion and ginger in a large bowl, cover and cook on HIGH power for 3 mins. or until softened.
2. Add the cumin, turmeric, cinnamon and chicken. Cover and cook on HIGH power for 1 minute.
3. Add the rice, stock, apricots and sultanas. Cover and cook on HIGH power for 10 mins. and then MEDIUM power for 8 mins. or until the chicken and rice are cooked.
4. Season to taste and cover and allow to stand 5 mins. before serving.

Tagliatelle Toscana

Serves 4

Dish: deep casserole dish

1. Sprinkle the aubergine with salt and leave for 20 mins. then rinse and dry.
2. Cook the pasta in 600 ml (1 pt) boiling water, covered, on HIGH power for 4 mins. or until tender. Drain.
3. Place onion, garlic and oil in a bowl, cover and cook on HIGH power for 2 mins. or until soft. Add the remaining ingredients except the mozzarella and parmesan cheese, cover and cook on HIGH power for 6 mins.
4. Mix the drained pasta with the mozzarella. Place in a casserole dish. Pour the sauce over the top. Sprinkle with parmesan. Cover and cook on HIGH power for 4-5 mins. until piping hot.

Vegetable Couscous

Serves 4

Dish: large casserole

1. Place all the vegetables in a large casserole with the spices, salt, garlic and chick peas. Add the hot vegetable stock. Cover and cook on HIGH power for 16-18 mins. or until the vegetables are tender.
2. Pour 450 ml ($\frac{3}{4}$ pt) of boiling water over the couscous. Allow to stand for 10 mins. Cover and cook on MEDIUM power for 5 mins. or until warm and fluffed. Separate the grains with a fork and serve with the vegetables.

Cheese and Egg Dishes

PIERCING

Always pierce egg yolk and white to stop them exploding when poaching or frying in a microwave.

Ingredients

1 garlic clove, halved
300 ml (½ pt) dry white wine
450 g (1 lb) Gruyère cheese, grated
25 g (1 oz) plain flour
Pinch of pepper
Pinch of grated nutmeg
Paprika for sprinkling

Ingredients

2 onions, finely chopped
50 g (2 oz) butter or margarine
225 g (8 oz) long grain rice
600 ml (1 pt) hot chicken stock
800 g (1½ lb) tin tomatoes
100 g (4 oz) mature cheddar cheese, grated
25 g (1 oz) Parmesan cheese, grated
salt and pepper
1 bunch of chives, chopped

Ingredients

15 ml (1 tbsp) olive or vegetable oil
½ red pepper, deseeded & diced
½ green pepper, deseeded & diced
1 onion finely chopped
4 eggs
3 ml (½ tsp) basil
salt and pepper to taste

BOILED EGGS IN SHELLS

Never attempt to cook a boiled egg by microwave. They can explode dangerously.

QUICHES

Always cook quiches on SIMMER power to avoid curdling the egg filling.

Swiss Cheese Fondue

Serves 4-6

Dish: large 2 litre (4 pt) bowl

1. Place garlic and wine in the bowl and cook on HIGH power for 4 mins., or until wine is just boiling.
2. In another bowl mix the cheese and flour together, until evenly combined.
3. Remove the garlic from the wine and discard. Add half of the cheese mixture, stirring constantly until the cheese melts.
4. Cook on HIGH power for 1 minute, then stir in the rest of the cheese mixture.
5. Return to the microwave and cook again for 1 minute on HIGH power. Season with pepper and nutmeg.
6. Sprinkle with paprika, if desired. Serve with chunks of french bread, or vegetables.

Cheesy Risotto

Serves 4

Dish: large casserole

1. Place the onions and butter in a large casserole. Cover and cook on HIGH power for 3 mins. or until softened.
2. Stir in the rice, cover and cook on HIGH for 1 minute.
3. Add the hot stock and tomatoes, cover and cook on HIGH power for 5 mins. and then MEDIUM power for 15 mins. or until the rice is cooked. Stir halfway during cooking.
4. Season and stir in 75 g (3 oz) cheese. Cover and leave to stand for 5 mins. (this enables the rice to absorb any excess stock).
5. Serve the Risotto sprinkled with remaining cheese and chives.

Piperade

Serves 2

Dish: 22 cm (9") Pyrex plate

1. Place oil and vegetables in a bowl, cover and cook on HIGH power for 3-4 mins. or until soft.
2. Grease the plate and spread with vegetables. Beat the eggs with salt and pepper and pour over the vegetables.
3. Cook on HIGH power for 3-4 mins. or until eggs are softly set, but still moist, beating with a fork several times during cooking. Allow to stand covered for 2 mins. before serving.

Ingredients

225 g (8 oz) shortcrust pastry
 1 medium onion, chopped
 15 ml (1 tbsp) oil
 6 streaky bacon rashers,
 or 100 g (4 oz) ham cut into strips
 2 eggs
 150 ml (¼ pt) single cream
 salt and pepper to taste
 50 g (2 oz) cheddar cheese, grated

Ingredients

675 g (1½ lb) new potatoes
 225 g (8 oz) broccoli florets
 150 ml (¼ pt) soured cream
 75 g (3 oz) Gruyère cheese, grated
 seasoning

Ingredients

175 g (6 oz) quick cooking macaroni
 40 g (1½ oz) butter
 1 small onion, finely chopped
 100 g (4 oz) bacon, chopped
 40 g (1½ oz) flour
 600 ml (1 pt) milk
 5 ml (1 tsp) french mustard
 150 g (5 oz) red cheese, grated
 salt and pepper
 30 ml (2 tbsp) fresh brown breadcrumbs

Quiche Lorraine

Serves 4

Dish: 20 cm (8") flan dish

1. Roll out pastry and use to line the flan dish. Prick base of pastry with a fork, chill for 15 mins. Line base of pastry with kitchen towel and cook on HIGH power for 4-5 mins. or until pastry is starting to dry.
2. Place the onion and oil in a small dish. Cover and cook on HIGH power for 2 mins. or until onion is soft. Drain onion and place in bottom of flan case.
3. Place bacon on a microwave rack and cook on HIGH power for 4 mins. or until starting to crisp. Cool and cut into bite-sized pieces. Place in flan case.
4. Beat the eggs, cream, salt and pepper and pour over the bacon. Sprinkle with cheese and cook uncovered on LOW power for 10-12 mins. or until just set.

Creamy Cheese, Potato & Broccoli Bake

Serves 4

Dish: large bowl + heatproof dish

1. Cut potatoes in half (or quarters if large). Place in a bowl with 90 ml (6 tbsp) of water and cook on HIGH power for 8 mins. covered with cling film.
2. Add the broccoli to the potatoes and cook for a further 4-6 mins. or until tender.
3. Mix together ½ the cheese and the cream.
4. Arrange the potato and broccoli in a heatproof dish in a single layer, pour the cream mixture over them and sprinkle the rest of the cheese on top.
5. Cook on HIGH power for 2-3 mins. until cheese melts.

Macaroni Cheese

Serves 4

Dish: large dish + jug

1. Cook macaroni in 450ml (¾ pt) boiling water on HIGH power for 5-6 mins. or until soft. Drain.
2. Place butter, onion and bacon in a jug. Cook on HIGH power for 5 mins. or until onion is soft. Stir halfway through cooking.
3. Stir in flour and cook for 30 secs. on HIGH power.
4. Gradually add milk stir well and season. Cook on HIGH power for 5 mins. or until sauce is thick and bubbling. Stir twice during cooking.
5. Add mustard and 100g (4oz) grated cheese. Place the macaroni in a large dish and pour over the sauce. Sprinkle with breadcrumbs and remaining cheese.
6. Cook on HIGH power for 2-3 mins. until the cheese starts to melt.

Vegetables and Vegetarian



- Root vegetables. i.e. carrots, swede, should be cut into slices, strips or cubes.
- Do not mix fresh and frozen vegetables as the cooking times may be different.



- Cabbage should be shredded and cooked by power and time.
- Fresh vegetables require 90 ml (6 tbsp) of water. For each extra 450 g (1 lb) add an extra 90 ml (6 tbsp) of water and stir halfway.



- If cooking potatoes with other vegetables, only cook with other ROOT vegetables.
- Never add salt to vegetables before microwaving. Remember the flavour of microwaved vegetables is much better than boiled.



- Always cook vegetables in a dish that is a suitable size. Use flat dishes not basins. Always cover with microwave cling film or a lid.



- Certain vegetables i.e. broccoli and asparagus, should be arranged so that the tips are in the centre of the dish, as these require less cooking.



- Whole cauliflower should be cooked upside down on MEDIUM power for 10 mins. approx. with 90 ml (6 tbsp) water. Make a cross with a knife in the stalk. Turn half way during cooking.

Jacket Potatoes

Varieties of potatoes vary in their suitability for cooking by microwave. We recommend Maris Piper for consistently good results. The cooking times given may need adjustment for other varieties. The ideal size of potato to be cooked by microwave is 200 g-250 g (7-9 oz).

Before Cooking

Wash potatoes and prick skins several times. Spread around edge of turntable.

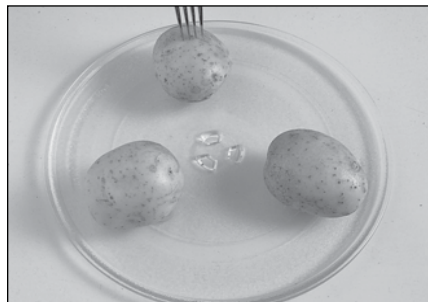

After Cooking

Remove from oven and wrap in aluminium foil to retain the heat. Leave to stand for 5 mins.

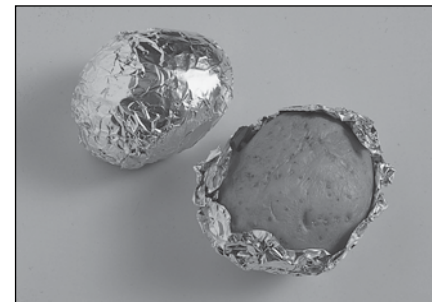

Ingredients

1 aubergine, sliced
 5 ml (1 tsp) salt
 1 courgette, sliced
 1 onion, sliced
 1 green pepper, trimmed and sliced
 1 clove of garlic, peeled and crushed
 396 g (14 oz) can of tomatoes
 30 ml (2 tbsp) olive oil
 salt and pepper to taste

Ingredients

1 clove of garlic, halved
 675 g (1½ lb) potatoes, sliced very thinly
 pinch nutmeg
 salt and pepper
 150 ml (¼ pt) double cream
 25 g (1 oz) butter

Ingredients

1 large onion, chopped
 25 g (1 oz) butter
 1 clove of garlic, crushed
 225 g (8 oz) each of diced carrots,
 diced leeks, diced courgettes
 1 green pepper, chopped
 150 ml (¼ pt) hot vegetable stock
 salt and pepper to taste
 300 ml (½ pt) prepared tomato sauce
 175 g (6 oz) pre-cooked lasagne
 225 g (8 oz) Mozzarella cheese

Ratatouille

Serves 4

Dish: 20 cm (8") casserole

1. In a colander sprinkle aubergine slices with salt and leave for 30 mins. to remove bitter juices. Rinse with cold water.
2. Combine all ingredients in a casserole. Cover and cook on HIGH power for 15 mins. or until vegetables are soft. Stir halfway through cooking time.

Gratin Dauphinois

Serves 4

Dish: 20 cm (8") shallow dish

1. Rub halves of garlic around inside of dish and discard.
2. Layer the potato slices in the dish, seasoning with salt and pepper and nutmeg between each layer.
3. Pour the cream evenly over the top of the potatoes and dot with butter. Cook on MEDIUM power for 12 mins.

Vegetable Lasagne

Serves 4-6

Dish: large shallow rectangular Pyrex® or heatproof dish

1. Place onion, butter and garlic in a casserole dish, cover and cook on HIGH power for 3 mins. Add vegetables and stock, re-cover and cook on HIGH power for 8-10 mins. or until vegetables are soft. Season to taste.
2. Cover base of dish with a thin layer of tomato sauce, then a layer of lasagne on top followed by a layer of vegetable mixture. Thinly slice 175 g (6 oz) of the cheese and layer on top of vegetables. Continue layering until ingredients are all used ending with a tomato sauce layer.
3. Grate remaining cheese and arrange over top in 3 diagonal bands. Cook on HIGH power for 20 mins. or until piping hot. Brown under a preheated grill if desired.

Ingredients

2 medium sweet potatoes
1 large tomato, sliced
50 g (2 oz) spicy sausage, sliced
30 ml (2 tbsp) coriander, chopped
75 g (3 oz) cheddar cheese, grated
salt and pepper

Ingredients

1 cauliflower, trimmed
90 ml (6 tbsp) water
25 g (1 oz) butter
25 g (1 oz) flour
3 ml (½ tsp) French mustard
300 ml (½ pt) milk
seasoning to taste

Topping:

75 g (3 oz) grated cheese
15 ml (1 tbsp) brown breadcrumbs

Ingredients

2 onions, chopped
15 ml (1 tbsp) olive oil
2 cloves garlic, crushed
1 large aubergine, chopped
2 courgettes, sliced
1 large red pepper, deseeded and sliced
1 large green pepper, deseeded and sliced
400 g (14 oz) can chopped tomatoes
300 ml (½ pt) vegetable stock
5 ml (1 tsp) chopped rosemary
10 ml (2 tsp) chopped thyme
100 g (4 oz) red lentils

Stuffed Sweet Potatoes

Serves 4

Dish: shallow heatproof dish

1. Wash and prick the potato skins. Cook on the Jacket Potato program.
2. Split the potatoes horizontally, keeping the edge joined.
3. Layer the tomatoes and the sausage alternately over the potatoes. Season and sprinkle with coriander and the grated cheese.
4. Cook on HIGH power for 2-3 mins. until the cheese melts.

Cauliflower Cheese

Serves 4

Dish: large bowl + shallow casserole

1. Place cauliflower upside down in a bowl. Add water. Cover and cook on MEDIUM power for 10 mins. or until tender. Drain.
2. Melt butter on HIGH power for 15-30 secs. Stir in flour and mustard. Cook for a further 15 secs. Add milk gradually. Stir well and season. Cook on HIGH power for 2-3 mins. or until sauce is thick and bubbling. Stir once halfway during cooking.
3. Stir in 50 g (2 oz) grated cheese. Pour the sauce over the cauliflower. Top with remaining cheese and breadcrumbs.
4. Cook on HIGH power for 1-2 mins. or until piping hot.

Red Lentil Casserole

Serves 4

Dish: large casserole

1. Place onions, oil, and garlic in the casserole. Cook on HIGH power for 3 mins.
2. Add chopped aubergine, courgettes, and peppers to the casserole. Cook on HIGH power for 4-5 mins.
3. Add the tomatoes, vegetable stock, herbs and lentils. Cook on HIGH power for 5 mins.
4. Stir and then cook on SIMMER power for 10-12 mins. or until lentils are tender.

Ingredients**Tomato Sauce:**

½ green pepper, chopped
1 onion, chopped
1 clove garlic, crushed
15 ml (1 tbsp) oil
397 g (14 oz) can chopped tomatoes
227 g (8 oz) can whole tomatoes
3 ml (½ tsp) ground cumin
3 ml (½ tsp) dried oregano
3 ml (½ tsp) chilli powder
salt and pepper

Enchiladas:

50 g (2 oz) cheddar cheese, grated
100 g (4 oz) cottage cheese
pinch salt
2 ml (½ tsp) chilli powder
pinch ground cumin
1 tomato, chopped
1 courgette, grated
½ green pepper, chopped
1 small onion, chopped
6 x 15 cm (6") corn tortillas or thin crepes

Ingredients

22.5 ml (1 ½ tbsp) olive oil
½ large red onion, chopped
450 g (1 lb) red cabbage, finely shredded
2 eating apples, cored, peeled and sliced
37 ml (2 ½ tbsp) light muscovado sugar
30 ml (2 tbsp) red wine vinegar
22.5 ml (1 ½ tbsp) red currant jelly
¼ tsp ground cinnamon
50 g (2 oz) flaked almonds, toasted

Ingredients

100 g (4 oz) black-eye beans, soaked overnight
100 g (4 oz) adzuki beans, soaked overnight
15 ml (1 tbsp) vegetable oil
1 garlic clove, crushed
1 yellow pepper, chopped
10 ml (2 tsp) caraway seeds, lightly crushed
15 ml (1 tbsp) paprika
397 g (14 oz) can chopped tomatoes
175 g (6 oz) mushrooms, thickly sliced
60 ml (4 tbsp) natural yoghurt
salt and pepper

Garnish:

fresh parsley, chopped

Vegetable Enchiladas

Serves 4

Dish: 20 x 25cm (8 x 10") shallow dish

1. Combine the green pepper, onion, garlic and oil in a bowl. Cover and cook on HIGH power for 3-5 mins. or until tender.
2. Stir in remaining sauce ingredients and cook uncovered on HIGH power for 5-7 mins. or until piping hot and thickened. Leave to one side.
3. Combine 25 g (1 oz) cheddar cheese in a small bowl with the cottage cheese, salt, chilli and cumin. Mix well.
4. Mix tomato, courgette, green pepper and onion in a bowl. Cover and cook on HIGH power for 4-6 mins. or until vegetables are tender. Drain and press lightly to remove excess moisture. Stir in half of the tomato sauce.
5. Spread the cheese mixture over each tortilla, top with vegetable mixture and roll up. Arrange tortillas seam side down in a shallow dish. Pour the remaining sauce down the centre.
6. Cook on MEDIUM power for 6-8 mins. or until piping hot.

Red Cabbage with Red Onion and Almonds

Serves 4-6

Dish: large bowl

1. Soften the onion on HIGH power for 2 mins.
2. Add all the other ingredients except the almonds, mix well and then cook on HIGH power for 10-12 mins. or until cabbage is softened. Stir halfway through cooking.
3. Stir in the almonds just before serving, so they retain their crunch.

Spicy Bean Goulash

Serves 4-6

Dish: large casserole

1. Drain the beans, rinse well and place in a large bowl. Add 600 ml (1pt) boiling water. Cover and cook on HIGH power for 15 mins. then LOW power for 30 mins. or until tender.
2. Place the oil, garlic, yellow pepper, caraway seeds and paprika in a large casserole. Cover and cook on HIGH power for 2 mins. or until softened.
3. Add drained, rinsed beans, tomatoes and mushrooms. Cover and cook on HIGH power for 8-10 mins. or until piping hot and the mushrooms are soft. Stir once during cooking.
4. Stir in 30 ml (2 tbsp) yoghurt and season to taste. Drizzle remaining yoghurt on top and sprinkle with parsley.

Puddings and Desserts

Ingredients

385 g (13 oz) can apple slices
100 g (4 oz) margarine
100 g (4 oz) light muscovado sugar
2 eggs
50 g (2 oz) ground almonds
50 g (2 oz) self raising flour
5 ml (1 tsp) ground mixed spice
60 ml (4 tbsp) flaked almonds

Ingredients

150 ml (1/4 pt) water
100 g (4 oz) caster sugar
3 eggs
3 ml (1/2 tsp) vanilla essence
30 ml (2 tbsp) caster sugar
300 ml (1/2 pt) cold milk

Ingredients

200 g (7 oz) fresh dates, stoned and finely chopped
175 g (6 oz) self-raising flour
5 ml (1 tsp) baking powder
5 ml (1 tsp) vanilla essence
15 ml (1 tbsp) Camp coffee essence
100 ml (3 1/2 fl. oz) milk
75 g (3 oz) butter
150 g (5 oz) caster sugar
2 eggs lightly beaten

Butterscotch sauce

45 g (1 3/4 oz) butter
120 ml (8 tbsp) soft brown sugar
200 ml (7 fl. oz) whipping cream
15 ml (1 tbsp) vanilla essence

Almond Eve's Pudding

Serves 4

Dish: 22 cm (8 1/2") Pyrex® or microwave safe dish

1. Arrange the apple slices in the base of the dish.
2. Beat together the remaining ingredients except the flaked almonds until smooth.
3. Spread over the top of the apples and sprinkle with flaked almonds.
4. Cook on MEDIUM power for 8-9 mins or until cooked. Test with a skewer to ensure the middle is cooked.

Creme Caramel

Serves 4

Dish: 15 cm (6") souffle dish

1. Put water and the 100 g (4 oz) of sugar in a souffle dish. Cook on HIGH power for 2-3 mins. or until sugar has dissolved. Continue cooking on HIGH power for 6-10 mins. until sugar has caramelised, keeping a close watch as it can burn easily: **CAUTION** - Remove from oven very carefully using oven gloves (the base will be extremely hot) and cool.
2. Beat eggs, essence, caster sugar and milk together and strain over caramel.
3. Cook on SIMMER power for 14-16 mins. or until starting to set around edge of dish. The custard will continue to set on cooling. Refrigerate for several hours before turning out.

N.B. Individual Creme Caramels can be prepared by dividing the above ingredients between 4 individual 9 cm (3 1/2") ramekins. Cook the sugar solution for approx. 10-12 mins. on HIGH power then cook the custards for approx. 11-13 mins. on SIMMER power.

Date Puddings and Butterscotch Sauce

Serves 6

Dish: 6 Individual microwave proof moulds

1. Pour 175 ml (6 fl. oz) boiling water over the chopped dates and set aside to cool.
2. Sift together flour and baking powder. Add vanilla and coffee essence to the milk.
3. Cream the butter and sugar until light and fluffy. Add eggs a little at a time.
4. Fold in the flour and flavoured milk, then pour in the date mixture.
5. Place in six moulds. Cook on HIGH power for 7 mins. and leave to stand for 10 mins.

Sauce

1. Place butter in a large jug and cook on HIGH power for 45 sec. to 1 minute, or until bubbling.
2. Add sugar and stir until it has dissolved cooking for 1 minute at a time on HIGH power. Continue to cook until liquid is foaming and bubbling 30 sec. at a time on HIGH power.
3. Slowly pour in the cream and bring to the boil on HIGH power for 2-3 mins. Add essence. Stir, continue to boil on HIGH power 30 sec. at a time until it starts to thicken.

Ingredients

2 lemons
 500 ml (18 fl oz.) full fat milk
 1 cinnamon stick
 grated nutmeg
 4 medium egg yolks
 50 g (2 oz) caster sugar
 30 ml (2 tbsp) cornflour
 100 g (4 oz) demerara sugar

Ingredients

4 medium sized apples
 30 ml (2 tbsp) sugar
 25-50 g (1-2 oz) mixed dried fruit
 25g (1 oz) butter

Ingredients

1 whole orange
 1 orange, juice and grated rind of
 175 g (6 oz) self-raising flour, sifted
 100 g (4 oz) soft margarine
 100 g (4 oz) caster sugar
 2 eggs, beaten
 100 g (4 oz) chocolate drops

Lemon Brûlée

Serves 4

Dish: 4 individual heatproof ramekins

1. Place the grated rind of the lemons with the milk, cinnamon and nutmeg in a large jug and cook on HIGH power for 4 mins. Allow to cool.
2. Whisk the egg yolks and caster sugar until pale and foamy, then stir in the cornflour.
3. Strain the milk into the egg mixture and then cook on HIGH power for 4-5 mins. or until thickened. Stir frequently.
4. Pour into 4 ovenproof dishes and allow to cool for 4 hours or overnight.
5. Sprinkle with remaining sugar and place under a hot grill to caramelize the top.

Baked Apples

Serves 4

Dish: 20cm (8") shallow dish

1. Core the apples and score the skin around the middle.
2. Mix together the sugar and fruit and fill the centres of the apples.
3. Dot the top with butter. Stand the apples in a suitable dish and cook on HIGH power for 5-7 mins. before serving.

The apples will look quite green when removed from the oven, but they should feel slightly soft when tested with a sharp knife. During the standing time, the colour will become dull and the apples will be tender. The apples will overcook very easily, so take care to undercook slightly. For 1 baked apple cook for 2-3 mins. For 2 baked apples cook for 3-5 mins.

Orange and Chocolate Drop Pudding

Serves 4-6

Dish: 1.2 litre (2 pt) pudding basin

1. Cut one orange into slices and arrange around the sides of the basin.
2. Mix flour, margarine, sugar, grated rind and orange juice and eggs and beat well until thoroughly mixed. Stir in chocolate drops. Spoon mixture into pudding basin and cook on HIGH power for 5-6 mins. or until just set.

Ingredients

30 g (1 ¼ oz) unsalted butter
125 g (4 ½ oz) arborio rice
600 ml (1 pint) milk
50 g (2 oz) granulated sugar
50 g (2 oz) fine plain Continental chocolate,
broken into pieces
50 g (2 oz) plain dark chocolate chips

Ingredients

150 g (5 oz) self-raising flour
pinch of salt
50 g (2 oz) caster sugar
50 g (2 oz) suet
1 egg
150 ml (¼ pt) milk
30 ml (2 tbsp) jam or golden syrup
Optional:
add 1 tbsp of sultanas to dry ingredients

Ingredients

1 cooking apple, peeled and grated
1 carrot, peeled and grated
1 orange, juice and grated rind of
400 g (14 oz) mixed dried fruit
45 ml (3 tbsp) brandy
15 ml (1 tbsp) black treacle
50 g (2 oz) self-raising flour
pinch of salt
15 ml (1 tbsp) cocoa
5 ml (1 tsp) mixed spice
3 ml (½ tsp) nutmeg
100 g (4 oz) shredded suet
150 g (5 oz) fresh breadcrumbs
50 g (2 oz) mixed peel
50 g (2 oz) flaked almonds
2 eggs, beaten

Chocolate Risotto Indulgence

Serves 4-6

Dish: Large bowl

1. Place butter in the bowl, cook on HIGH power for 1 min. to melt.
2. Stir in the rice and ensure all grains are coated with a little butter.
3. Add the milk and the sugar to the rice, cook on HIGH power for 10 mins. stir at the end of cooking.
4. Cook on Simmer power for 7 mins.
5. Add the plain Continental chocolate to the rice mixture, stir well and then cook for a further 11-12 mins. on Simmer power, or until thickened.
6. Allow to cool slightly then stir in the chocolate chips just before serving.
7. Serve immediately with clotted cream, mascarpone or vanilla ice cream.

Steamed Suet Sponge Pudding

Serves 4

Dish: 1 litre (2 pt) pudding basin

1. In a mixing bowl, sift together the flour and salt. Stir in the sugar and suet.
2. Make a well in the centre and add beaten egg and milk. Mix to a soft dropping consistency.
3. Put the jam in the base of the greased pudding basin and pour pudding mixture over. Cook on HIGH power for 5-6 mins. until firm.

Christmas Pudding

Serves 6-8

Dish: 1.3 litre (2½ pt) pudding basin lightly greased

1. Place apple and carrot in a large bowl. Cover and cook on HIGH power for 5 mins. Beat well to make a thick puree.
 2. Stir in juice, rind and mixed fruit. Cook on HIGH power for 2 mins. Stir in brandy and treacle. Stand for 5 mins. Beat in rest of ingredients.
 3. Press into the pudding basin. Cover with greaseproof paper and cook on HIGH power for 4 mins. Stand for 5 mins. Cook on HIGH power for another 2 mins. or until just firm.
- N.B.** One of the advantages of using your microwave to make this traditional pudding is that it can be made the week before Christmas and stored in a cool dry place. **Do not** attempt to make the pudding earlier than this, since the flavour will not improve with keeping, unlike a traditionally steamed pudding.

Sauces

CONTAINER SIZE

Always use a container or jug at least twice the capacity of the sauce, to avoid boiling over.

COVERING

DO NOT cover sauces when cooking.

Ingredients

30 g (1 oz) butter
30 g (1 oz) flour
600 ml (1 pt) milk

Variations of White Sauce

Parsley

Stir 60 ml (4 tbsp) chopped parsley and 15 ml (1 tbsp) lemon juice into sauce halfway through cooking time.

Onion

Cook 1 small onion in the butter for 30 secs. on HIGH power before adding the flour and milk.

Ingredients

30 ml (2 tbsp) custard powder
15 ml (1 tbsp) sugar
600 ml (1 pt) cold milk

Ingredients

3 egg yolks
30 ml (2 tbsp) white wine vinegar
100 g (4 oz) chilled, unsalted butter, cut into cubes
pepper

STIRRING – IMPORTANT

Sauces/gravy should be thoroughly stirred before, during and after cooking, to avoid any eruptions and to result in a smooth sauce.

REHEATING

Sauces can be made in advance and reheated by microwave. Reheat on HIGH power and stir halfway.

POWER LEVEL

Most sauces require HIGH Power for cooking. Sauces containing eggs should be cooked on SIMMER power.

WOODEN SPOONS

Do not leave wooden spoons in the sauce when cooking. The wood may dry out and burn. NEVER LEAVE metal spoons in the sauce.

White Pouring Sauce

Dish: 1 litre (2 pt) jug

1. Melt butter in jug on HIGH power for 20-40 secs.
2. Stir in the flour to make a roux.
3. Add the milk gradually stirring continuously until well combined.
4. Cook for 2 mins. on HIGH power. Stir and cook for a further 3 mins. Sauce should be smooth and glossy and coat the back of a spoon.

Custard

Dish: 1 litre (2 pt) jug

1. Mix together the custard powder, sugar and a little milk to form a smooth paste.
2. Blend in the remaining milk, whisking well.
3. Cook on HIGH power for 4-6 mins. Whisk well halfway through cooking time and again at the end.

Hollandaise Sauce

Dish: 1 litre (2 pt) jug

1. Place egg yolks and vinegar in a jug. Beat well.
2. Drop cubes of butter on top. Cook on HIGH power for 15 secs.
3. Whisk. Cook on HIGH power for 10 secs.
4. Whisk again and cook on HIGH power for 10 secs. Repeat 10 secs. stages until sauce is thick and creamy.
5. Season and serve immediately with salmon steaks or asparagus spears.

N.B. This sauce must not boil or eggs will curdle.

Baking Guidelines

DISH SHAPE

Ring moulds are ideal for baking cakes in, especially dense cakes. They help prevent the outside edge of the cake overcooking before the dense centre is cooked through.

KEEPING QUALITY

Light sponge type cakes cook very quickly by microwave and so should be cooked as required, since their keeping quality is not as long as those baked traditionally.

Ingredients

100 g (4 oz) self raising flour
100 g (4 oz) soft margarine
100 g (4 oz) caster sugar
2 eggs
30 ml (2 tbs) milk

Ingredients

2 eggs beaten
150 ml (¼ pt) vegetable or corn oil
150 g (5 oz) self-raising wholemeal flour
100 g (4 oz) soft light brown sugar
10 ml (2 tsp) cinnamon
75 g (3 oz) raisins
100 g (4 oz) carrots, grated

Icing

50 g (2 oz) cream cheese
50 g (2 oz) butter
100 g (4 oz) icing sugar
10 ml (2 tsp) lemon juice
50 g (2 oz) walnuts, chopped

CONSISTENCY

Generally cakes to be cooked by microwave should have a softer consistency than those baked traditionally. As a general rule add 15-30 ml (1-2 tbs) of milk or water to the mixture.

COVERING

Just as you wouldn't cover a cake baked in a traditional oven, NEVER cover your cakes cooked by microwave.

DISH SIZE

Always use the exact dish size stated in the following recipes, otherwise cooking times and results will be affected.

MIXING/BEATING

Cakes cooked by microwave need to be well mixed, but not over beaten. Generally it is unnecessary to cream butter and sugar or beat eggs in an electric mixer or food processor. Do not attempt to cook whisked/fatless sponges, or any cakes containing whisked egg white.

EGGS

The following recipes have been tested using medium eggs. Using a different size of egg may affect cooking times.

Sponge Cake

Dish: 18 cm (7") soufflé dish, based lined with greaseproof paper

1. Combine all ingredients together in a large bowl. Mix well until smooth. Tip into prepared dish and smooth the top.
2. Cook on MEDIUM power for 3½-4 mins. Cool for 10 mins. before turning out onto a rack. The cake is cooked when it has just dried on the top. Do not overcook as overcooked cakes stale quickly.

Carrot Cake

Dish: 25 cm (10") ring mould, based lined with greaseproof paper

1. Mix eggs and oil together.
2. Combine flour, sugar, cinnamon, raisins and carrots in a mixing bowl. Pour egg mixture into flour and stir well until well combined.
3. Pour into ring mould and cook on MEDIUM power for 7-8 mins. or until firm. Stand for 10 mins. before turning out.
4. Beat cream cheese and butter until smooth. Gradually beat in icing sugar and lemon juice. Spread over sides and top of cake and sprinkle with walnuts.

Ingredients

75 g (3 oz) butter or margarine
 30 ml (2 tbsp) golden syrup
 75 g (3 oz) light brown sugar
 150 g (5 oz) porridge oats
 50 g (2 oz) raisins

Ingredients

100 g (4 oz) butter or margarine
 100 g (4 oz) golden syrup
 100 g (4 oz) black treacle
 75 g (3 oz) soft brown sugar
 100 g (4 oz) self-raising flour
 100 g (4 oz) plain wholemeal flour
 5 ml (1 tsp) mixed spice
 30 ml (2 tsp) ground ginger
 5 ml (1 tsp) bicarbonate of soda
 pinch salt
 150 ml (1/4 pt) milk
 2 eggs beaten

Ingredients

100 g (4 oz) plain chocolate
 100 g (4 oz) butter
 100 g (4 oz) soft dark brown sugar
 100 g (4 oz) self-raising flour
 10 ml (2 tsp) cocoa powder
 pinch salt
 2 eggs, beaten
 3 ml (1/2 tsp) vanilla essence
 100 g (4 oz) walnuts, chopped

Chewy Flapjacks

Makes: 8 slices

Dish: 20 cm (8") round flan dish

1. Place butter, syrup and sugar in a bowl and cook on HIGH power for 1-2 mins. or until melted.
2. Stir in the oats and raisins. Press into dish. Cook on HIGH power for 3-4 mins. or until firm. Allow to cool slightly then cut into pieces.

Ginger Cake

Dish: 20 cm (8") Soufflé dish base lined with greaseproof

1. Place butter, syrup, treacle and sugar in a bowl and heat on HIGH power for 1-2 mins. or until fat has melted.
2. Place flours, spices, bicarbonate and salt in a large bowl. Stir in treacle mixture and mix well. Stir in milk and eggs and beat until smooth.
3. Pour into cake dish and cook on MEDIUM power for 8-9 mins. or until set around edges. The cake will appear slightly wet in centre, but will continue cooking as it cools.

Boston Brownies

Dish: 20 cm (8") square dish base lined with greaseproof

1. Place chocolate and butter in a bowl and cook on HIGH power for 1 minute or until chocolate has melted.
2. Stir in all other ingredients and beat well.
3. Pour into dish and cook on MEDIUM power for 6 mins. or until just slightly sticky. Allow to cool and then cut into squares.

Preserves

STERILIZING JARS

Jam jars can be sterilized by microwave ready for your jams. Half fill with water and heat them on HIGH power until water boils (approx. 3 mins. for 2 jars). Empty and drain upside down on kitchen paper. The jars should be warm when filled with jam.

If you wish to cook larger quantities than given in the recipes below, revert to the traditional hob method, using a traditional recipe.

Ingredients

450 g (1 lb) soft fruit, washed
450 g (1 lb) caster sugar
30 ml (2 tbsp) lemon juice
5 ml (1 tsp) butter

Ingredients

4 lemons, grated rind and juice of
450 g (1 lb) caster sugar
4 eggs, beaten
100 g (4 oz) butter

Ingredients

450 g (1 lb) seville oranges
1 lemon
900 ml (1½ pts) water
450 g (1 lb) sugar
knob of butter

DISH SIZE

Always use a very large pyrex bowl. DO NOT attempt to use jam pans or saucepans in your microwave.

DO NOT LEAVE JAMS UNATTENDED DURING COOKING BECAUSE OF THE HIGH SUGAR CONTENT.

COVERING

Do not cover preserves whilst cooking, apart from if recommended in the recipe.

WE DO NOT RECOMMEND THAT YOU USE YOUR MICROWAVE TO STERILIZE BABIES' BOTTLES.

(See details on pages 24 and 25)

DO NOT SEAL PRESERVING JARS IN YOUR MICROWAVE.

SETTING POINT

To determine whether setting point is reached, place a couple of drops of jam or marmalade on a cold saucer (put one in the fridge whilst making the jam). Leave to cool. The jam should wrinkle on the surface when your finger pushes across the top.

Soft Fruit Jam

Makes approx. 1½ lbs jam

Dish: large bowl

1. Place all ingredients in a large bowl and stir. Cook on HIGH power for 5 mins. (10-15 mins. if using frozen fruit), stirring frequently. Continue to cook in one minute intervals until sugar has dissolved.
2. Wash down any sugar crystals from around the bowl.
3. Bring mixture to the boil and continue to cook until setting point is reached – approx. 15-25 mins. Test regularly for setting point.

Lemon Curd

Makes 2 lbs

Dish: large bowl

1. Place all ingredients in bowl. Mix well.
2. Cook on HIGH power for 1 min. Stir. Continue to cook in 1 minute stages until mixture starts to thicken, then cook for 30 secs. at a time until mixture coats back of spoon. (The eggs will curdle if overcooked).
3. The mixture will thicken on cooling. Pot into warm jars. Cover with a circle of waxed paper and a jam pot cover.

Orange Marmalade

Makes 1½-2lbs

Dish: large bowl

1. Grate oranges and lemon ensuring all the pith is left on the fruit.
2. Place the peeled fruit in a food processor and chop until the pips are broken.
3. Place the chopped mixture in a large bowl and pour over boiling water. Cover and cook on HIGH power for 10 mins.
4. Strain the mixture through a sieve into another large bowl pressing the pulp well until all the juice is extracted. Discard the pulp.
5. Stir the shredded rind into the hot juice and cook uncovered on HIGH power for 10 mins. until rind is tender, stirring occasionally. Stir in the sugar until dissolved.
6. Cook on HIGH for 8 mins covered. Stir in the butter and cook to setting point 4-6 mins.
7. Leave to stand for 10 mins then pour into warmed sterilized jars.

Ingredients

675 g (1½ lb) plums or damsons
 200 ml (7 fl. oz) water
 675 g (1½ lb) sugar
 30 ml (2 tbsp) lemon juice
 5 ml (1 tsp) butter

Ingredients

675 g (1½ lb) tomatoes
 225 g (8 oz) cooking apples, peeled and sliced
 1 medium onion, chopped
 100 g (4 oz) granulated sugar
 30 ml (2 tbsp) tomato puree
 5 ml (1 tsp) salt
 200 ml (7 fl. oz) white distilled vinegar
 10 ml (2 tsp) ground ginger
 2 ml (¼ tsp) cayenne pepper
 3 ml (½ tsp) mustard powder

Ingredients

45 ml (3 tbsp) olive oil
 4 large red onions halved and thinly sliced
 50 g (2 oz) demerara sugar
 100 g (4 oz) sultanas
 300 ml (½ pint) red wine
 125 ml (4 fl.oz) red wine vinegar

Plum Jam

Makes approx. 2-2½ lbs jam

Dish: large bowl

1. Prick the plums and place in a large bowl with the water. Cook on HIGH power for 5-10 mins. or until the fruit is soft. Add the rest of ingredients. Cook on HIGH power for 5 mins. stirring frequently.
2. Wash down any sugar crystals from around the bowl and bring to the boil on HIGH power. Continue to cook until setting point is reached - approx. 15-20 mins., opening the door and testing regularly. Leave to cool slightly, remove the stones, then pot, seal and label.

Tomato Chutney

Makes approx. 2 lbs

Dish: large bowl

1. Prick the tomatoes and place in a bowl. Cover with boiling water and leave for 5 mins. Drain. Peel off skin and roughly chop flesh.
2. Blend apple and onion in a food processor to a thick puree.
3. Combine all ingredients together in a bowl. Cook on HIGH power for 25-30 mins., stirring occasionally, or until the mixture is thick with no excess liquid.
4. Leave to stand covered for 10 mins. then stir and pour into sterilised jars. Cover and label.

Red Onion Chutney

Makes approx 1½ - 2 lbs

Dish: large bowl

1. Put oil in bowl with onions. Soften on HIGH power for 10 minutes, stirring halfway.
2. Add all other ingredients and mix well.
3. Cook on MEDIUM power for 20 mins, or until onions are soft.
4. Cool slightly, then pour into a jar.
5. Allow to cool thoroughly before chilling.

Questions and Answers

Q My microwave oven causes interference with my TV, is this normal?

A Some radio and TV interference might occur when you cook with the microwave oven. This interference is similar to the interference caused by small appliances such as mixers, vacuums, hair dryers, etc. It does not indicate a problem with your oven.

Q Sometimes warm air comes from the oven vents. Why?

A The heat given off from the cooking food warms the air in the oven cavity. This warmed air is carried out of the oven by the air flow pattern in the oven. There isn't an airtight seal to the air therefore steam can escape. There are no microwaves in the air, or steam. The oven vents should never be blocked during cooking.

Technical Specifications

Rated Voltage: 230-240 V 50 Hz

Operating Frequency: 2,450 MHz

Input Power: Microwave 1260 W (**NN-SD466/SD456**)
1160 W (**NN-SD446**)

Output Power: Microwave 900 W (IEC-60705)
1000 W Turbo Reheat (IEC-60705)

Outer Dimensions: 510 (W) x 380 (D) x 304 (H) mm

Oven Cavity Dimensions: 359 (W) x 352 (D) x 217 (H) mm

Weight: 12 kg

Weight and Dimensions are approximate.

This product is an equipment that fulfills the European standard for EMC disturbances (EMC = Electromagnetic Compatibility) EN 55011. According to this standard this product is an equipment of group 2, class B and is within required limits. Group 2 means that radio-frequency energy is intentionally generated in the form of electromagnetic radiation for purpose of warming or cooking food. Class B means that this product may be used in normal household areas.

Building-in Your Oven

1. In case of fitting into an oven housing, please use Panasonic's Trim Kit
NN-TKV63WBBP - white
NN-TKV63MBBP - silver
2. Microwave ovens should **not be built** into a unit **directly above** a top front venting conventional cooker. This will invalidate your one year guarantee.
3. A microwave which is built in must be more than 850 mm above floor level. Read Trim-Kit instructions carefully before installation.

It is recommended that the microwave oven is placed below a convectional oven to avoid heat damage to the fascia of the microwave.

Information on Disposal for Users of Waste Electrical & Electronic Equipment (private households)



This symbol on the products and/or accompanying documents means that used electrical and electronic products should not be mixed with general household waste.

For proper treatment, recovery and recycling, please take these products to designated collection points, where they will be accepted on a free of charge basis. Alternatively, in some countries you may be able to return your products to your local retailer upon the purchase of an equivalent new product.

Disposing of this product correctly will help to save valuable resources and prevent any potential negative effects on human health and the environment which could otherwise arise from inappropriate waste handling. Please contact your local authority for further details of your nearest designated collection point.

Penalties may be applicable for incorrect disposal of this waste, in accordance with national legislation.

For business users in the European Union

If you wish to discard electrical and electronic equipment, please contact your dealer or supplier for further information.

Information on Disposal in other Countries outside the European Union

This symbol is only valid in the European Union.

If you wish to discard this product, please contact your local authorities or dealer and ask for the correct method of disposal.

Index

A

Adapting Recipes.....	34
Apples, poached/stewed.....	30
Arcing.....	7
Auto weight cooking	21-23
Auto weight defrosting.....	17-18

B

Babies bottles	7,24,25
Bacon	
Rashers	29
Baked Apples.....	52
Baking guidelines.....	55
Beans, cooking chart	29
Beef	
guidelines.....	39
cooking charts.....	29
Belgian Beef Casserole	41
Bolognese Sauce.....	40
Steak and Kidney Pudding	41
Boil in the bag fish	30
Building in	59

C

Cakes

Boston Brownies.....	56
Carrot Cake	55
Chewy Flapjacks.....	56
Ginger Cake.....	56
Sponge Cake	55

Chaos defrost.....

Cheese and Egg Dishes

Cheesey Risotto	45
Creamy Cheese, Potato & Broccoli Bake	46
Macaroni Cheese.....	46
Piperade	45
Quiche Lorraine	46
Swiss Cheese Fondue.....	45

Chicken

guidelines.....	39
cooking charts.....	29
Chicken Casserole.....	42
Chicken Satay.....	41
Fruity Chicken Risotto.....	44
Child Lock.....	14
Christmas Pudding	53

reheating.....	6, 26
Cleaning your Microwave	4
Cling Film.....	9, 12
Clock, setting the time	15
Containers to use.....	11-12
Control Panels	13
Cooking Charts.....	29-33
Custard	54
reheating.....	26

D

Defrosting

guidelines.....	19
charts	20
Delay/Stand feature	16
Demo Mode	14

E

Eggs boiled	6,8,45
Eggs poached/scrambled	30

F

Fan motor operation	7
---------------------------	---

Fish

guidelines.....	36
cooking charts.....	30
Family Fish Pie	37
Fish Balti	38
Fish Kebabs.....	38
Plaice Provencal.....	38
Poached Smoked Haddock	37
Salmon and Vegetable Mornay.....	37
Stuffed Citrus Trout.....	36
Fruit, poached and stewing.....	30

G

General Guidelines.....	9-10
-------------------------	------

H

Hollandaise Sauce.....	54
------------------------	----

J

Jacket Potatoes	22, 23, 33, 47
Jam	57, 58

K	
Kedgeree	43
L	
Lamb	
guidelines.....	39
cooking charts.....	31
Chops	31
Lamb Casserole.....	40
Lamb in a spicy cream & almond sauce	40
Lemon Curd	57
M	
Meat and Poultry guidelines	39
Meat and Poultry recipes	40-42
Microwave power levels.....	15
Microwave principles	8
Milk puddings.....	32
Milk puddings, reheating.....	27
Mince pies, reheating.....	24,27
O	
Orange Marmalade.....	57
P	
Pasta, cooking	31
Pasta and Rice recipes	
Kedgeree	43
Fruity Chicken Risotto	44
Pesto Spaghetti	43
Tagliatelle Toscana	44
Tuna Pasta Bake	43
Vegetable Couscous.....	44
Plated Meals	27
Pork	
guidelines.....	39
cooking	31
chops	31
Paprika Pork Casserole	42
Sweet and Sour	42
Porridge	31
Preserves	
Soft Fruit Jam	57
Lemon Curd.....	57
Orange Marmalade.....	57

Plum Jam.....	58
Red onion Chutney	58
Tomato Chutney.....	58
Pulses, cooking.....	29
Puddings and Desserts	
Almond Eve's Pudding.....	51
Baked Apples.....	52
Chocolate Risotto Indulgence.....	53
Christmas Pudding	53
Creme Caramel	51
Date Puddings and Butterscotch Sauce	51
Lemon Brûlée	52
Orange and Chocolate Drop Pudding.....	52
Steamed Suet Sponge Pudding	53
R	
Reheating guidelines	24
Reheating Charts.....	25-28
Rice, cooking	31-32
S	
Sauces	54
Sausages.....	32
Shielding.....	18-19
Soups and Starters	
Broccoli & Stilton Soup	35
Coarse Pork Pâtés.....	35
Garlic Mushrooms with Herbs.....	35
Standing Times.....	9
T	
Technical Specification	59
Turbo Reheat.....	16
V	
Vegetables + Vegetarian	
guidelines.....	47
cooking	32-33
Cauliflower cheese	49
Gratin Dauphinois.....	48
Ratatouille.....	48
Red Cabbage with Red Onions and Almonds	50
Red Lentil Casserole	49
Spicy Bean Goulash	50
Stuffed Sweet Potatoes	49
Vegetable Enchiladas	50
Vegetable Lasagne	48
W	
White Sauce	54

**PHONE OUR
CUSTOMER CARE CENTRE**

08705 357357

For service or spares.

Or order spares direct on line at
www.panasonic.co.uk



Panasonic®

For **COOKERY ADVICE** call:

01344 862108

Open 3 days a week

Home Economists will provide friendly guidance on queries
relating to recipes and cooking in your microwave.

F00038G30BP