

Operation Guide
Microwave Oven



Model Numbers:

NN-ST786W / NN-ST756W

Panasonic[®] Panasonic[®]

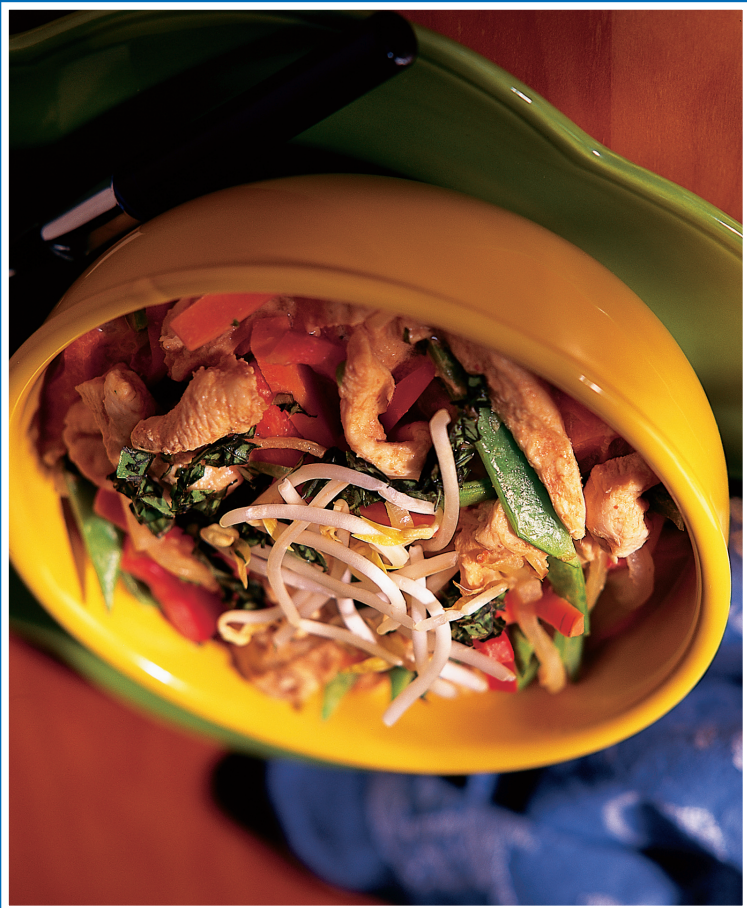

Cook book
Microwave Oven



Safety Instructions

Precautions to be taken when using Microwave Ovens for Heating foodstuffs

INSPECTION FOR DAMAGE. A microwave oven should only be used if an inspection confirms all of the following conditions:

1. The door fits squarely and securely and opens and closes smoothly.
2. The door hinges are in good condition.
3. The metal plates of a metal seal on the door are neither buckled nor deformed.
4. The door seals are neither covered with food nor have large burn marks.

PRECAUTIONS. Microwave radiation from microwave ovens can cause harmful effects if the following precautions are not taken:

1. Never tamper with or deactivate the interlocking devices on the door.
2. Never poke an object, particularly a metal object, through a grille or between the door and the oven while the oven is operating.
3. Never place saucepans, unopened cans or other heavy metal objects in the oven.
4. Do not let other metallic articles, e.g., fast food foil containers, touch the side of the oven.
5. Clean the oven cavity, the door and the seals with water and a mild detergent at regular intervals. Never use any form of abrasive cleaner that may scratch or scour surfaces around the door.
6. Always use the oven with trays or cookware recommended by the manufacturer.
7. Never operate the oven without a load (i.e., an absorbing material such as food or water) in the oven cavity unless specifically allowed in the manufacturer's literature.
8. For horizontally hinged doors, never rest heavy objects such as food containers on the door while it is open.
9. Do not place sealed containers in microwave ovens. Baby bottles fitted with a screw cap or a teat are considered to be sealed containers.
10. The appliance is not intended for use by young children or infirm persons without supervision.
11. Young children should be supervised to ensure that they do not play with the appliance.

Important Instructions

WARNING—To reduce the risk of burns, electric shock, fire, injury to persons or excessive microwave energy:

1. Read all instructions before using the microwave oven.
2. Some products such as whole eggs and sealed containers - (for example, closed glass jars **and sealed baby bottles with teat**) - may explode and should not be heated in the microwave oven.
3. Use this microwave oven only for its intended use as described in this manual.
4. As with any appliance, close supervision is necessary when used by children.
5. Do not operate this microwave oven if it is not working properly or if it has been damaged or dropped.

6. To reduce the risk of fire in the oven cavity:
 - (a) Do not overcook food. Carefully attend microwave oven if paper, plastic, or other combustible materials are placed inside the oven to facilitate cooking.
 - (b) Remove wire twist-ties from bags before placing bag in oven.
 - (c) If materials inside the oven should ignite, keep oven door closed, turn oven off at the wall switch, or shut off power at the fuse or circuit breaker panel.

Earthing Instructions

This microwave oven must be earthed. In the event of an electrical short circuit, earthing reduces the risk of electric shock by providing an escape wire for the electric current. This microwave oven is equipped with a cord having an earthing wire with an earthing plug. The plug must be plugged into an outlet that is properly installed and earthed.

WARNING—Improper use of the earthing plug can result in a risk of electric shock.

WE CERTIFY THAT THIS MICROWAVE OVEN HAS BEEN INSPECTED AND COMPLIES WITH THE REQUIREMENTS OF REGULATION 3, SUBCLAUSE(2), OF THE MICROWAVE OVENS REGULATIONS 1982.
MATSUSHITA ELECTRIC INDUSTRIAL CO.,LTD.

(This statement applicable only to New Zealand.)

We certify that this microwave oven has been inspected and complies with the safety requirements of government notice 466 of March 1981, and complies with the Radio Regulation of government notice 587 of March 1986.

(This statement applicable only to South Africa)

WARNING

- a) The door seals and door seal areas should be cleaned with a damp cloth. The appliance should be inspected for damage to the door seals and door seal areas and if these areas are damaged the appliance should not be operated until it has been repaired by a qualified service technician trained by the manufacturer.
- b) It is dangerous for anyone other than a qualified service technician trained by the manufacturer to perform repair services.
- c) If the supply cord of this appliance is damaged, it must be replaced by a qualified service technician with the special cord available only from the manufacturer.
- d) Before use, the user should check that utensils are suitable for use in microwave ovens.
- e) Liquids or other foods must not be heated in sealed containers since they are liable to explode.
- f) Only allow children to use the oven without supervision when adequate instructions have been given so that the child is able to use the oven in a safe way and understands the hazards of improper use.

Installation and General Instructions

General Use

1. In order to maintain high quality, do not operate the oven when empty. The microwave energy will reflect continuously throughout the oven if no food or water is present to absorb energy.
2. If smoke is observed, press the **STOP/RESET** Pad and leave door closed in order to stifle any flames. Disconnect the power cord, and/or shut off power at the fuse or circuit breaker panel.
3. Do not dry clothes, newspapers or other materials in oven. They may catch on fire.
4. Do not use recycled paper products, unless the paper product is labelled as safe for microwave oven use. Recycled paper products may contain impurities which may cause sparks and/or fires when used.
5. Do not use newspapers or paper bags for cooking.
6. Do not hit or strike the Control Panel. Damage to controls may occur.
7. POT HOLDERS may be needed as heat from food is transferred to the cooking container and from the container to the Glass Tray. The GlassTray can be very hot after removing the cooking container from the oven.
8. Do not store flammable materials next to, on top of, or in the oven. It could be a fire hazard.
9. Do not cook food directly on Glass Tray unless indicated in recipes. (Food should be placed in a suitable cooking utensil.)
10. **DO NOT** use this oven to heat chemicals or other non-food products. **DO NOT** clean this oven with any product that is labelled as containing corrosive chemicals. **The heating of corrosive chemicals in this oven may cause microwave radiation leaks.**
11. Look at the oven from time to time when food is heated or cooked in disposal containers of plastic, paper or other combustible materials, as these types of containers ignite if overheated.

Placement of Oven

1. The oven must be placed on a flat, stable surface. For correct operation, the oven must have sufficient air flow. **Allow 15 cm of space on the top of the oven, 10 cm at the back, and 5 cm on both sides. If one side of the oven is placed flush to wall, the other side or top must not be blocked. Do not remove feet.**
 - a. Do not block air vents. If they are blocked during operation, the oven may be overheated and damaged. When using any cloth over the oven, the air intake and exhaust should not be blocked. Also allow sufficient space on back and both sides of the oven.
 - b. Do not place oven near a hot or damp surface such as a gas stove, electric range or sink etc.
 - c. Do not operate oven when room humidity is too high.
2. This oven was manufactured for household use only.
3. This oven may be built into a wall cabinet, if desired. This microwave oven is designed and approved for use only with a genuine Panasonic trim kit for Model number listed in the operating instructions (page 21). Installation with any other trim kit may void the warranty.

Circuits

Your microwave oven should be operated on a separate 10 A circuit from other appliances. Failure to do this may cause the power board fuse to blow, and/or food to cook slower. Do not insert higher value fuse in the power board.

Food

1. Do not use your oven for home canning or the heating of any closed jar. Pressure will build up and the jar may explode. In addition, the microwave oven cannot maintain the food at the correct canning temperature. Improperly canned food may spoil and be dangerous to consume.
2. Do not attempt to deep fry in your microwave oven.
3. Do not boil eggs in their shell and whole hard-boiled eggs (unless otherwise stated in Cooking Guide section). Pressure will build up and the eggs will explode.
4. Potatoes, apples, egg yolks, chicken wings, whole squash and sausages are examples of foods with nonporous skins. This type of food must be pierced before cooking, to prevent bursting.
5. When heating liquids, e.g. soup, sauces and beverages, in your microwave oven, overheating the liquid beyond boiling point can occur without evidence of bubbling. This could result in a sudden boil over of hot liquid. To prevent this possibility the following steps should be taken:
 - a) Avoid using straight-sided containers with narrow necks.
 - b) Do not overheat.
 - c) **Stir** the liquid before placing the container in the oven and halfway through cooking time.
 - d) After heating, allow to stand in the oven for a short time, stirring again before carefully removing the container.
6. **DO NOT USE A CONVENTIONAL MEAT THERMOMETER IN THE MICROWAVE OVEN. To check the degree of cooking of roasts and poultry use a MICROWAVE THERMOMETER.** Alternatively, a conventional meat thermometer may be used after the food is removed from the oven. If undercooked, return meat or poultry to the oven and cook for a few more minutes at the recommended power level. It is important to ensure that meat and poultry are thoroughly cooked.
7. **COOKING TIMES given in the Cooking Guide section are APPROXIMATE.** Factors that may affect cooking time are preferred degree of moisture content, starting temperature, altitude, volume, size, shape of food and utensils used. As you become familiar with the oven, you will be able to adjust for these factors.
8. **It is better to UNDERCOOK RATHER THAN OVERCOOK foods.** If food is undercooked, it can always be returned to the oven for further cooking. If food is overcooked, nothing can be done. Always start with minimum cooking times recommended.
9. Extreme care should be taken when cooking popcorn in a microwave oven. Cook for minimum time as recommended by manufacturer. Use the directions suitable for the wattage of your microwave oven. **NEVER** leave oven unattended when popping popcorn.
10. When heating food in plastic or paper containers, check the oven frequently due to the possibility of ignition.
11. The contents of feeding bottles and baby food jars are to be stirred or shaken and the temperature is to be checked before consumption, in order to avoid burns.

Microwaves and How They Work

Microwaves are a form of high frequency radio waves similar to those used by a radio, including AM, FM and CB. They are similar to a television where the radio waves are converted to a picture on the screen. However, microwaves are much shorter than radio waves; approximately twelve centimetres wave length. Electricity is converted into microwave energy by the magnetron tube (which is the heart of the microwave oven).

From the magnetron tube, microwave energy is transmitted to the oven cavity through a small plastic covered piece. The microwaves are converted to heat in the food. The microwaves enter from the outside of the food and travel through the food losing half of their power every two to three centimetres. Continued cooking to the centre occurs by conduction.

Although pacemakers used to be affected by microwaves (as well as by other radio waves), they are now shielded and are not bothered by these interferences. This allows people with pacemakers to sit calmly by their radio or television and cook with microwave ovens.

When microwaves come in contact with a substance, any one or combination of three things may occur.

They can be:

1. REFLECTED
2. TRANSMITTED
3. ABSORBED

Reflection:

Metal substances REFLECT microwave energy and because there is no absorption, there is no heating. This is why the oven interior is either stainless steel or epoxy-coated steel. This ensures that the microwaves are kept inside the cavity and evenly distributed throughout the food with the help of the turntable.

Transmission:

Such substances as paper, glass and plastic TRANSMIT microwave energy and do not become hot except from food. Because these substances do not reflect or absorb microwave energy, they are ideal materials for microwave cooking containers.

Absorption:

Food contains moisture and will ABSORB microwave energy, which causes the moisture molecules within the food to vibrate at an incredible rate (2,450,000,000 times per second). Friction, created by the vibration, produces heat energy which is conducted throughout the food.

Cookware and Utensils Guide

It is important to use the correct container when cooking in a microwave oven. The following will help you make the right selection.

How to Test a Container for Safe Microwave Oven Use

TO TEST A CONTAINER FOR SAFE MICROWAVE OVEN USE: Fill a 1-cup glass measure with cool water and place it in the microwave oven alongside the empty container to be tested; **heat one (1) minute at P10.** If the container is microwave oven-safe (transparent to microwave energy), the container should remain comfortably cool, the water in glass measure should be hot. If the container is hot, it has absorbed some microwave energy and should NOT be used. This test cannot be used for plastic containers.

Paper Products and Freezer Wrap

Waxed paper, paper plates, cups and napkins should not be used for heating or cooking food. Freezer wrap should not be used as it is not heat resistant and may melt. Paper towel, greaseproof paper and bake paper may be safely used for short periods of time for covering or lining.

Glass, Ceramic and China

Heat-Resistant glass cookware is invaluable in microwave cooking. Many of these items are readily available in most homes: glass jugs, mixing bowls, loaf dishes, covered casseroles, oblong baking dishes, pie plates and round or square cake dishes. Examples of this type of cookware are Pyrex® and Corningware®.

Dinnerware can be used for microwave heating. Many brands of dinnerware are microwave safe. Check the care information for reference to microwave use for dinnerware and serving pieces. If dinnerware is marked ovenproof, it frequently is safe to use in the microwave oven. However, to be sure, check by conducting microwave dish test previously mentioned.

Several types of glassware and dinnerware are not recommended for use in the microwave oven. Do not use dishes with metallic trim or containers with metal parts. Do not use cups or mugs with glued on handles, as they may fall off with continued heating. Do not use delicate glassware. Although the glassware may be transparent to microwave energy the heat from the food may cause the glassware to crack.

Cookware and Utensil Guide *(continued)*

Plastics

Plastic dishes, cups and some freezer containers should be used with care in a microwave oven.

Choose plastic containers carefully, as some plastic containers may become soft, melt and may scorch. The majority of plastic dishes, even those designed for use in the microwave oven, are not suitable for cooking foods with high fat or sugar content, or for lengthy cooking times. Most microwave plastic dishes should not be used for longer than 3 to 5 minutes on **P10** power. These dishes, although not suitable for extended cooking, may be used successfully for defrosting or for use on lower power levels.

Cooking Bags designed to withstand boiling, freezing, or conventional heating are microwave safe. Prepare bags according to manufacturer's directions. When cooking by microwave, **DO NOT** use wire twist-ties to close bag. They can act as an antenna and cause arcing (sparks).

DO NOT COOK IN PLASTIC FOOD STORAGE BAGS.

Plastic Wrap such as GLAD WRAP® can be used to cover dishes in most recipes. Over an extended heating time, some disfiguration of the wrap may occur. When removing plastic wrap "covers", as well as any glass lid, be careful to remove it away from you to avoid steam burns.

Loosen plastic but let dish stand, covered.

Jars and Bottles

Jars and bottles can be used to warm food to serving temperature, if the lid is removed first. Cooking should not be done in these containers since most are not heat resistant and during extended heating times, heat from food would cause cracking or breaking.

Metal

Metal cookware or utensils, or those with metallic trim, should **NOT** be used in the microwave. Since microwave energy is reflected by metal, foods in metal containers will not cook evenly. There is also a possibility of "arcing."

Although metal utensils should be avoided in microwave cooking, some metal can be helpful when used correctly.

Aluminum foil can be used safely, if certain guidelines are followed, to prevent overcooking. Small pieces of foil are used to shield areas such as chicken wings, tips of roasts, or other thin parts that cook before the rest of the recipe is finished. Make sure foil is attached securely and doesn't touch sides of oven, otherwise arcing may occur. Foil lined containers, either cardboard or plastic, should **NOT** be used in the microwave oven as arcing could occur.

Metal twist-ties, either paper or plastic coated, should **NOT** be used in the microwave oven. Frozen dinner trays can be used in the microwave, if the container is no deeper than 2 cm and is filled with food. Metal skewers can not be used in microwave ovens as arcing may occur. Wooden skewers are readily available and give the same result.

Shells: Scalloped baking shells are best used during reheating and for short periods of cooking time only.

Thermometers are available for use in microwave ovens. **DO NOT USE CONVENTIONAL MERCURY TYPE CANDY OR MEAT THERMOMETERS** in food while cooking in the microwave oven.

Straw, Wicker and Wood

Straw and wicker baskets may be used in the microwave oven for short periods of time to warm rolls or bread. Large wooden utensils, such as bowls or cutting boards should **NOT** be used for prolonged heating as the microwave energy may cause the wood to become dry and brittle.

Feature Diagram

Glass Tray

1. Do not operate the oven without the Roller Ring and Glass Tray in place.
2. Only use the Glass Tray specifically designed for this oven. Do not substitute another Glass Tray.
3. If Glass Tray is hot, allow to cool before cleaning or placing in water.
4. **Do not** cook directly on Glass Tray. Always place food on a microwave-safe dish, or on a rack set in a microwave-safe dish.
5. If food or utensil on Glass Tray touches oven walls, causing the tray to stop moving, the tray will automatically rotate in opposite direction. This is normal.
6. Glass Tray can rotate in either direction.

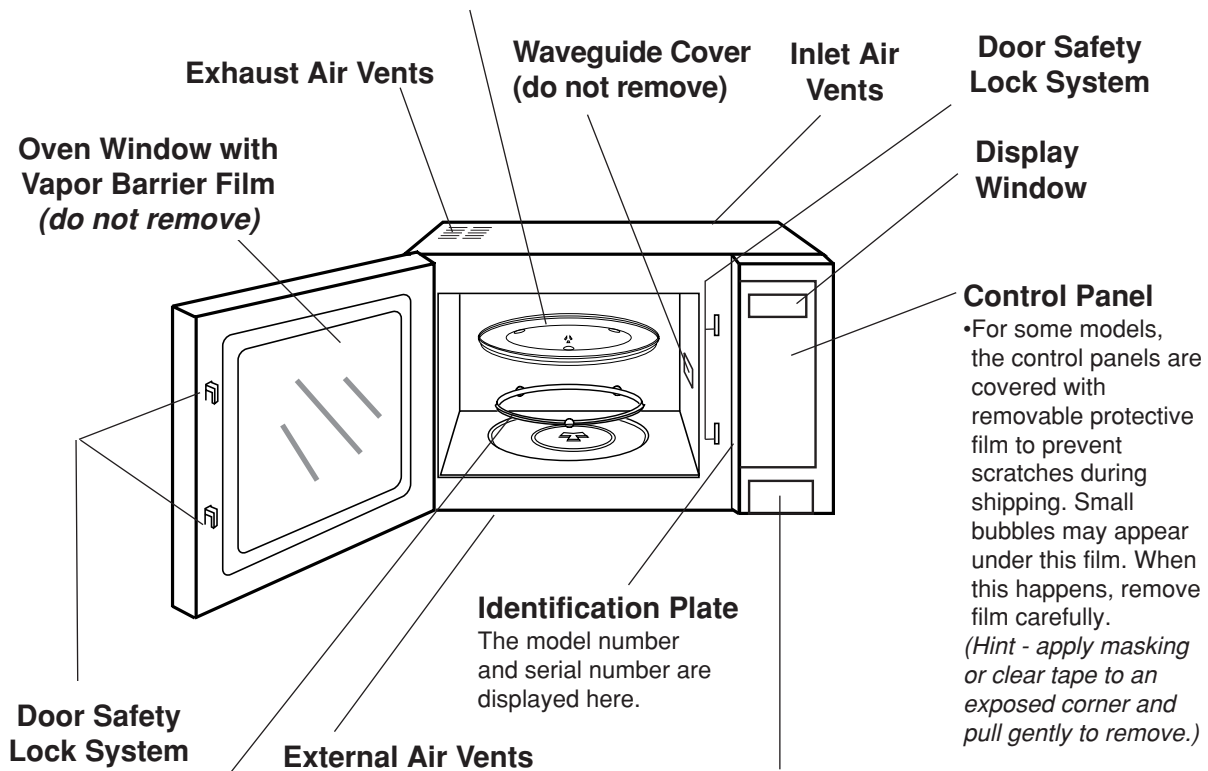

Roller Ring

1. The Roller Ring and oven floor should be cleaned frequently to prevent excessive noise and scratching of painted surface.
2. The Roller Ring must always be used together with the Glass Tray for cooking.

Door Release Button

Press to open the door. Opening the door during cooking will stop the cooking process without cancelling the program. Cooking resumes as soon as the door is closed and **Start Pad** is pressed. It is quite safe to open the door at any time during a cooking program and there is no risk of Microwave exposure.

Oven Light:

Oven Light will turn on during cooking and also when door is opened.

Control Panels

NN-ST786W

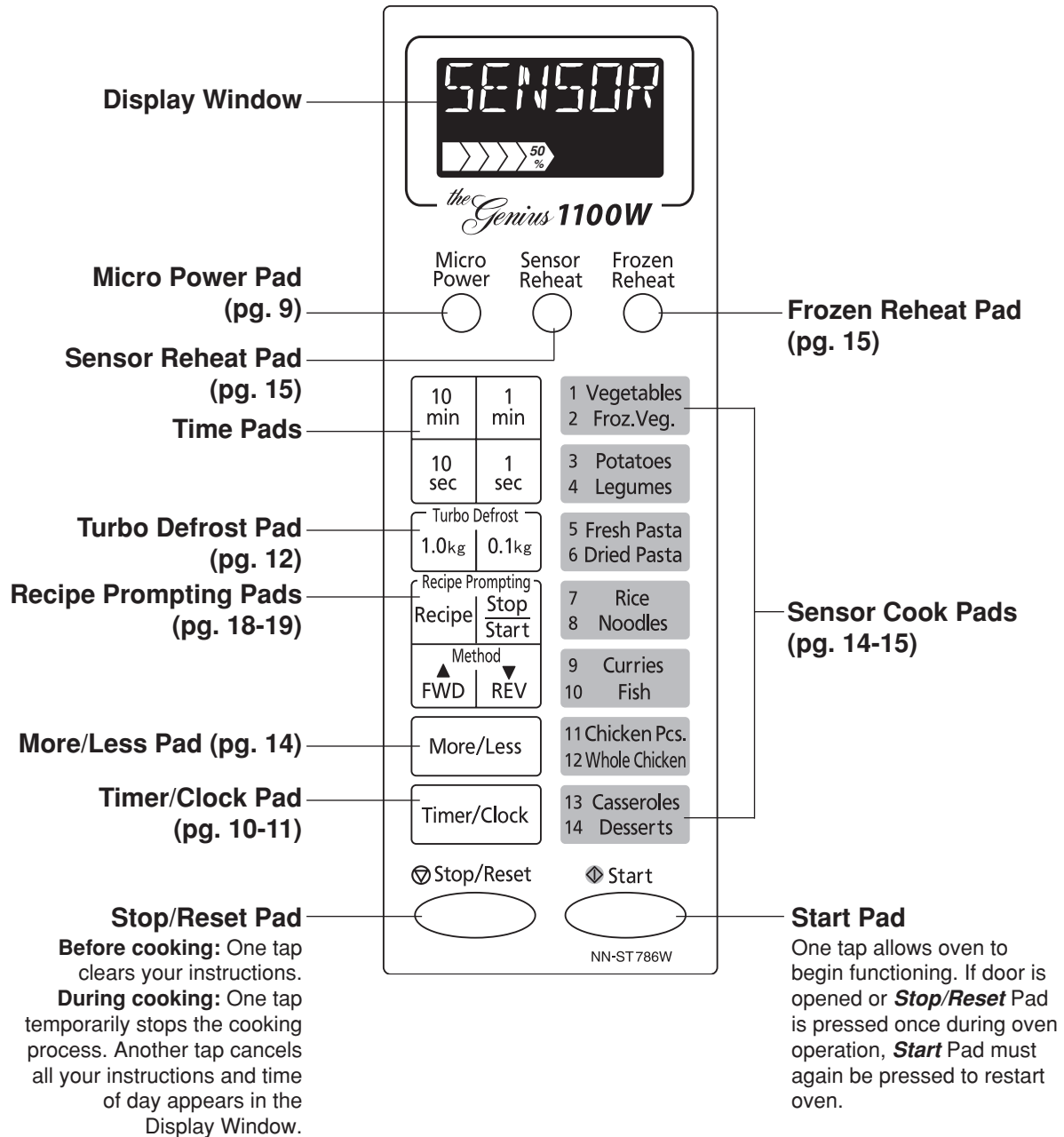

Word Prompters

When pads are pressed, a beep sound is heard and the corresponding letter or word(s) appear and roll across the Display Window. If a pad is pressed and no beep is heard, the unit does not or cannot accept the instruction. As each pad is pressed the corresponding word(s) roll across the Display Window. Words will automatically appear to prompt the user to perform the next step. It is not necessary to wait for the words to appear before pressing pads for the next step. A two beep sound is heard between stages. At the end of any complete programme, the oven will beep five times and "ENJOY YOUR MEAL" will appear in the Display Window.

Control Panels

NN-ST756W

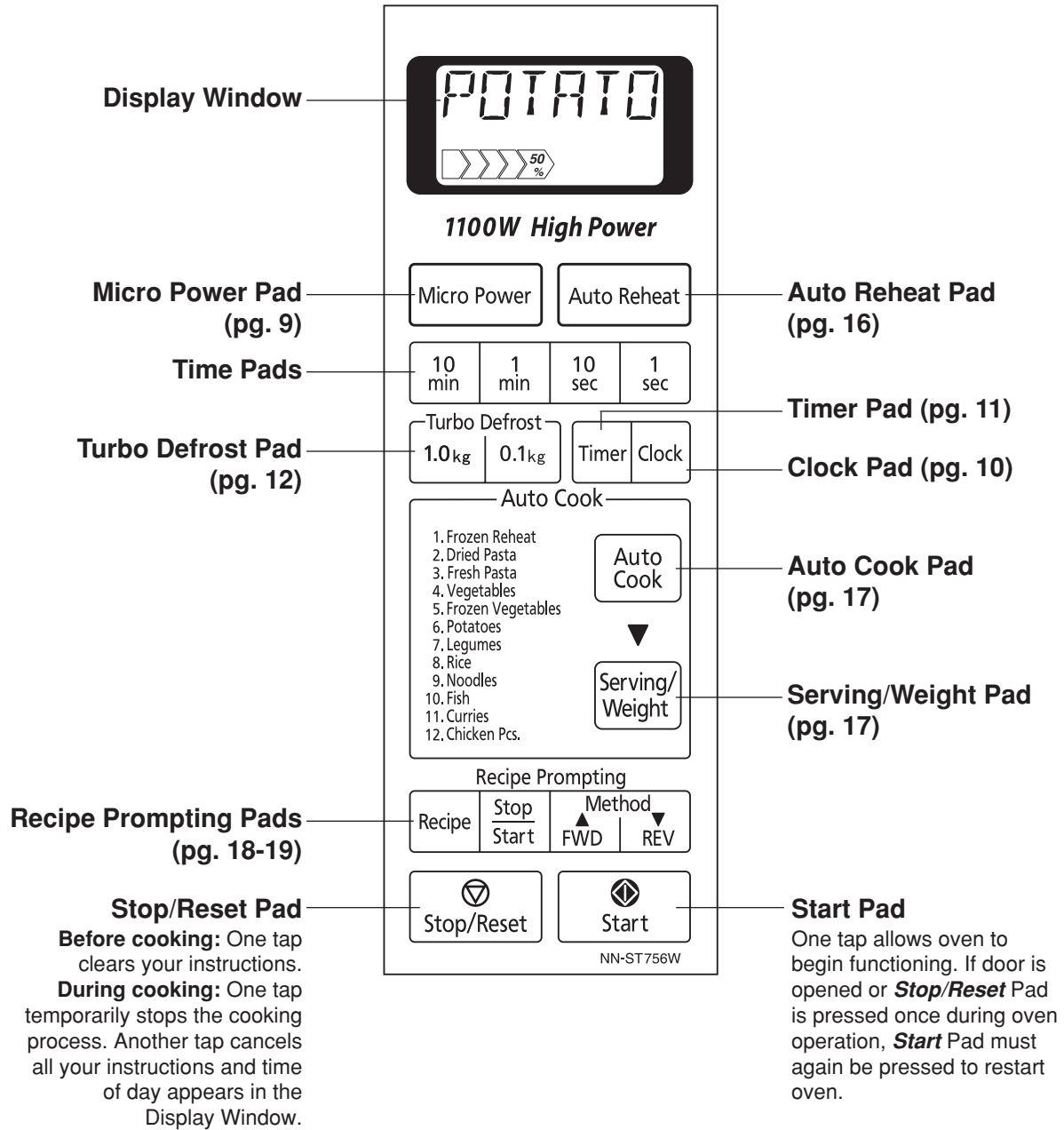

Let's Start To Use Your Oven!

1 Plug in

Plug into a properly earthed electrical outlet. "WELCOME TO PANASONIC MICROWAVE OVEN COOKING" appears in the Display Window. (This will immediately cease when any pad is pressed.)

2 Open Door

Open the door and place container with food on Glass Tray in the oven. Then close the door.

3 Select Power Level

e.g. P7

Press **Micro Power** Pad four times.
(see page 9 for Micro Power chart)

NN-ST786W



or

NN-ST756W



4 Set Time

e.g. 1 minute 30 seconds

Press numbered Time Pads

NN-ST786W

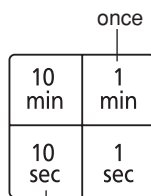

3 times

NN-ST756W

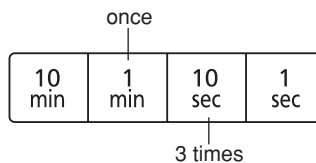

3 times

NN-ST786W



NN-ST756W



5 Press

Verify your selection(s) in the Display Window.

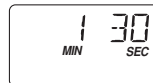

Operation Guide in the Display Window

To assist you in programming your oven, the following operation will appear in the Display Window. When you become familiar with your oven, the Operation Guide can be turned off.

To turn off:

NN-ST786W

NN-ST756W



or



OPERATION GUIDE OFF

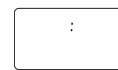

Press 3 times.

Display Window

Colon or time of day appear in the Display Window.

To turn on:

NN-ST786W

NN-ST756W

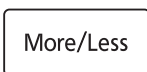

or



OPERATION GUIDE ON

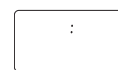

Press 3 times.

Display Window

Colon or time of day appear in the Display Window.

To Cook / Reheat / Defrost by Micro Power and Time

1 Select Power Level

Press **Micro Power** Pad until the power level appears in the Display Window. (see chart below)

NN-ST786W



or

NN-ST756W



Note: When selecting P10 on the first stage, you can start from step 2.

2 Set Cooking Time e.g. 5 minutes

(P10: up to 30 minutes, other powers: up to 99 minutes and 99 seconds for a single stage)

NN-ST786W

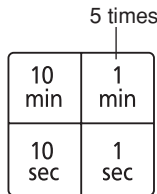

or

NN-ST756W

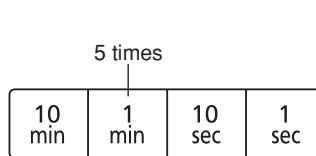

NN-ST786W



or

NN-ST756W



3 Press

Cooking will start.
The time in the Display Window will count down.

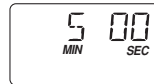

For more than one stage cooking,

Repeat steps 1 & 2 above then press **Start**. The maximum number of stages for cooking is 3. The oven will beep twice between stages.

e.g. : Casserole

Stage 1

Stage 2

P10 for 10 minutes
to bring to a boil

P2 for 50 minutes
to finish cooking by simmering

Micro Power:

The **Micro Power** Pad gives you a selection of different power levels representing decreasing amounts of microwave energy, used for cooking foods at different speeds.

e.g. The lower the micro power setting, the more evenly the food cooks, although it will take a little longer.

To select the correct power level for cooking different foods, refer to the chart below.

Press	POWER LEVEL	WATTAGE	EXAMPLE OF USE
1x	P10	1100 W	Boil water. Cook vegetables, rice, pasta and noodles. Reheating.
2x	P9	1000 W	Cook fresh fruits.
3x	P8	900 W	Cook cakes, desserts. Heat milk.
4x	P7	800 W	Cook pork, whole chicken and chicken pieces.
5x	P6	700 W	Cook beef, lamb and eggs. Melt butter.
6x	P5	600 W	Cook meatloaves. Melt chocolate.
7x	P4	400 W	Cook fish and seafood.
8x	P3	300 W	Thaw foods. Cook christmas pudding, corned beef, dried beans and peas.
9x	P2	200 W	Simmer soups, stews and casseroles (less tender cuts).
10x	P1	100 W	Keep cooked foods warm, simmer slowly.

To Set Clock

You can use the oven without setting the clock.

- 1 Press** **NN-ST786W** **Timer/Clock** ^{twice} or **NN-ST756W** **Clock** ^{once}

Colon will blink in Display Window.

2 Enter Time of Day

Enter time of day using Time Pads e.g. 12:35

Clock is a 12 hour display. There isn't a.m. or p.m. setting.

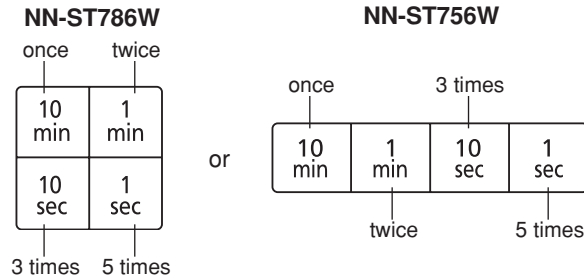

3 Press

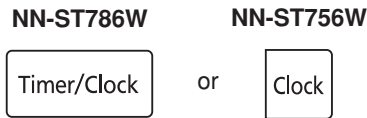

Colon stops blinking; time of day is entered and locked into Display Window.

12:35

NOTES: 1. Oven will not operate while colon is still blinking

2. To reset time of day, repeat step 1 through 3.

3. The clock will keep the time of day as long as oven is plugged in and electricity is supplied.

4. Maximum time available is 12:59. Clock is 12 hour only.

To Use Child Safety Lock

This feature allows you to prevent operation of the oven by a young child; however, the door will open. You can set Child Safety Lock when colon or time of day is displayed.

To set:

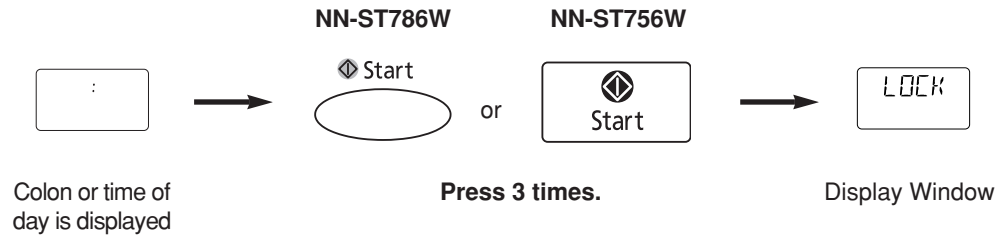

To cancel:

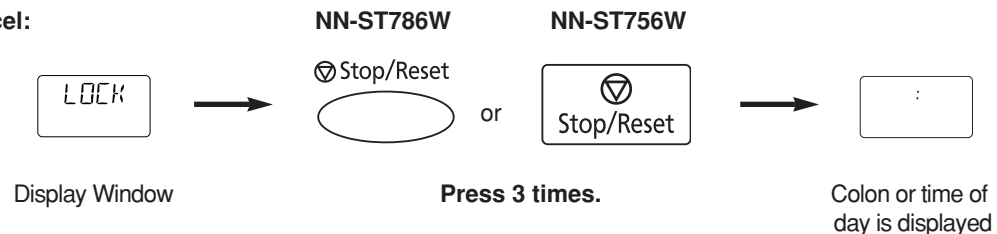

To Use Timer Pad

To Use as a Kitchen Timer

Press.

Set desired amount of time.
(up to 99 minutes and 99 seconds)

Press Start.
Time will count down
without oven operating.

NN-ST786W

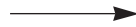

10 min	1 min
10 sec	1 sec

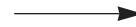

NN-ST756W



10 min	1 min	10 sec	1 sec
-----------	----------	-----------	----------



To Set Standing Time

Press.

Set desired amount of standing time.
(up to 99 minutes and 99 seconds)

Press Start.
Cooking will start.
After cooking, standing
time will count down
without oven operating.

NN-ST786W

Set the desired
cooking programme.
(see Page 9)

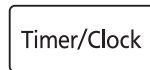

10 min	1 min
10 sec	1 sec



NN-ST756W

Set the desired
cooking programme.
(see Page 9)



10 min	1 min	10 sec	1 sec
-----------	----------	-----------	----------



To Set Delay Start

Press.

Set desired amount of delay time.
(up to 99 minutes and 99 seconds)

Press Start.
Delayed time will count
down. Then cooking
will start.

NN-ST786W



10 min	1 min
10 sec	1 sec



Set the desired
cooking programme.
(see Page 9)



NN-ST756W



10 min	1 min	10 sec	1 sec
-----------	----------	-----------	----------



Set the desired
cooking programme.
(see Page 9)



NOTES:

1. If oven door is opened during the Standing Time, Delay Start or Kitchen Timer, the time in the Display Window will continue to count down.
2. Delay Start cannot be programmed before any Auto Control function. This is to prevent the standing temperature of the food from rising before defrosting or cooking begins. A change in the starting temperature could cause inaccurate results and / or food may deteriorate.

To Defrost

Turbo Defrost or Weight Defrost

This feature allows you to defrost meat, poultry and seafood automatically by just setting the weight of the food.

1 Set Weight

The shape and size of the food will determine the maximum weight the oven can accommodate. The recommended maximum weight of food depends on the oven cavity size. Weight must be programmed in kilograms and tenths of a kilogram (max 3.0 kg).

NN-ST786W/T756W

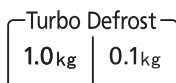

Enter weight.

NN-ST786W



NN-ST756W



2 Press

Defrost time appears in the Display Window and begins to count down. When cooking time is longer than 60 minutes, the time will appear in hours and minutes.

NOTES:

For further information, refer to next page.

Defrost by Micro Power and Time Setting

NN-ST786W

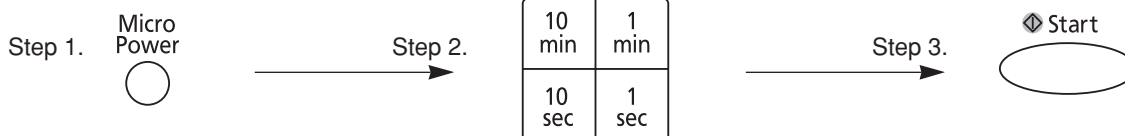

NN-ST756W

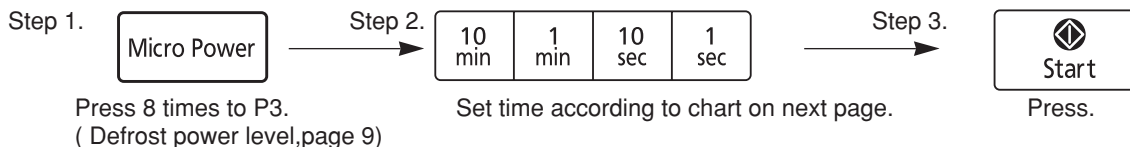

Defrosting Tips and Techniques

Preparation for Freezing:

1. Heavy-duty plastic wraps, bags and freezer wrap are suitable.
2. Freeze meats, poultry and fish in packages with only 1 or 2 layers of food. To aid in separating layers, place two pieces of wax paper between them.
3. REMOVE ALL AIR and seal securely.
4. LABEL package with type and cut of meat, date and weight.
5. Defrosting times given in the charts are for thoroughly frozen foods (i.e. at least 24 hours in freezer maintained at -18°C or lower).

Defrosting Technique:

1. Remove from wrapper and set on a defrosting rack in a dish on Glass Tray.
2. On Turbo Defrost, the oven will beep during the defrosting time. At "beep", turn over all meat, poultry, fish and shellfish. Break apart stewing meat, chicken pieces and minced meat. Separate chops and hamburger patties. Shield thin ends of roasts, poultry legs and wings, fat or bones with foil.
3. Throughout the defrosting time, remove any defrosted portions of mince or cubed meat, etc.
4. After defrosting, large roasts may still be icy in the centre. Let stand, 15 to 30 minutes, in refrigerator to complete defrosting.

Defrosting Chart (by setting Micro Power at P3):

FOOD	APPROX. TIME (minutes per 500 g)	INSTRUCTION
MEAT		
Beef		
Minced Beef	7 - 9	Halfway through the defrost cycle, break apart minced beef, separate chops and remove meat that is defrosted.
Roast: Topside	8 - 10	
Beef Tenderloin	8 - 10	
Chuck or Rump	8 - 10	Turn meat over two to three times during defrosting.
Sirloin, rolled	8 - 10	
Steak	6 - 8	Shield edges and unevenly shaped ends of roasts halfway through the defrost cycle.
Miscellaneous	7 - 9	
Pork/Lamb		
Roast	8 - 10	Large roasts may still be icy in centre. Let stand.
Chops	6 - 8	
Ribs	6 - 8	
POULTRY		
Chicken		
whole	8 - 10	Turn poultry over two to four times during defrosting. Halfway through the defrost cycle, shield end of drumsticks, wings, breast bones and ends of poultry with foil.
pieces	7 - 9	
fillets	7 - 9	Break apart chicken pieces and remove small pieces such as wings, which may be defrosted before larger pieces.
Duck	7 - 9	
Turkey	8 - 10	Rinse poultry under cold water to remove ice crystals. Let stand 5 to 10 minutes, before cooking.
FISH & SHELLFISH		
Fish Fillets	8 - 10	Halfway through the defrost cycle, turn whole fish or blocks of fillets over. Also, break apart prawns or scallops.
Whole Fish	7 - 9	
Crabmeat	6 - 8	Remove any pieces that are defrosted.
Lobster Tails	6 - 8	
Sea Scallops	6 - 8	Let stand, 5 to 10 minutes, before cooking.
Green Prawns	6 - 8	

To Cook Using **Sensor Cook** (for NN-ST786W) (S)

Sensor Cook

1 Select Category e.g. Rice or Noodles

To select the lower category on the key pads, keep pressing the food category pad

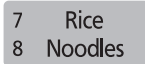

press once for rice
press twice for noodles
Category appears in the display window.

NOTE: When cooking using the automatic sensor, all food must be covered securely with plastic wrap. Do not use plastic containers as a secure seal cannot be achieved and inaccurate cooking may occur.

More/Less Pad:

Preferences for food doneness varies with each individual. After having used Sensor Cook a few times, you may decide you prefer your food cooked to a different doneness. By using the **More/Less** Pad, the Auto Sensor programmes can be adjusted to cook food for a longer or shorter time. Press **More/Less** Pad before pressing **Start** Pad.

- 1 tap : More cooking with indication "MORE+"
- 2 taps: Less cooking with indication "LESS-"
- 3 taps: Returns to average cooking result.

If you are satisfied with the result of the **SENSOR COOK** programme, you don't have to use this pad.

2 Press



Note: The door should not be opened before the countdown time appears in the Display Window.

- 3** After the heat and humidity is detected by the SENSOR, the remaining cooking time appears in the Display Window and begins to count down. When cooking time is longer than 60 minutes, the time will appear in hours and minutes.

Sensor Reheat (for NN-ST786W)

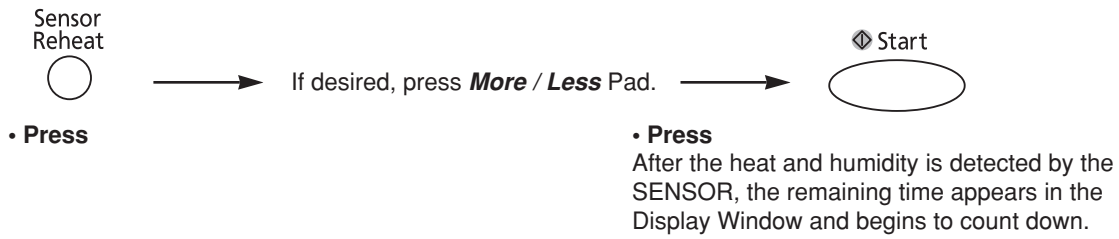

For best results on Sensor Reheat, follow these recommendations:

1. Food being reheated should weigh between 125 g and 1.0 kg. For foods weighing less than 125 g and more than 1.0 kg, use a manual micro power setting.
2. All foods must be previously cooked and at room or refrigerator temperature (for sensor reheat) or frozen at -18°C for at least 24 hours (for frozen reheat).
3. Foods should always be covered loosely, but completely, with plastic wrap. (Do not use any snap closing lids.)
4. All foods should have a covered stand time of at least 3 to 5 minutes.
5. **Do not** reheat bread or pastry products (raw or uncooked), or beverages.
6. **Do not** use if oven cavity is warm (from previously cooked foods).

Consult the following Recipe Chapters for Sensor Cooking Instructions for Each Category on your oven.

Menu	Recommended Weight
Sensor Reheat	
- Sensor Reheat	125 g - 1.0 kg
- Frozen Reheat	125 g - 1.0 kg
1 Vegetables	125 g - 500 g
2 Frozen Vegetables	125 g - 1.0 kg
3 Potatoes	125 g - 1.0 kg
4 Legumes	1 - 4 cups
5 Fresh Pasta	125 g - 625 g
6 Dried Pasta	125 g - 500 g
7 Rice	1 cup - 2½ cups
8 Noodles	150 g - 800 g
9 Curries	250 g - 750 g
10 Fish	125 g - 500 g
11 Chicken Pieces	400 g - 1.0 kg
12 Whole Chicken	1.0 kg - 2.0 kg
13 Casseroles	500 g - 2.0 kg
14 Desserts	375 g - 1.5 kg

To Reheat Food Using **Auto Reheat** (for NN-ST756W)

1 Press



Press the **Auto Reheat** Pad.

2 Press



Press the desired **Serving/Weight** Pad until the desired food serving/weight appears in the Display Window. (see below chart)

NO. OF TAPS	DISPLAY	RECOMMENDED FOOD WEIGHT
1	250 g	200 - 300 g
2	450 g	400 - 500 g
3	650 g	600 - 700 g
4	850 g	800 - 900 g

3 Press



Reheating time appears in the Display Window and begins to count down.

For best results on Auto Reheat, follow these recommendations:

1. All foods must be precooked. Suitable for casseroles, plated dinners, soups, stews, pasta dishes (except lasagne), canned foods.
2. Foods should be reheated from room temperature or refrigerator temperature. Do not reheat frozen foods on this setting.
3. Foods should be covered loosely but completely with plastic wrap or a casserole lid which does not snap seal.
4. Foods weighing less than 200 g and more than 900 g should be reheated by Micro Power and Time only.
5. All foods should have a covered stand time of 3 to 5 minutes at the end of reheating.
6. **Do not** reheat bread or pastry products; raw, uncooked or frozen foods; or beverages.

To Cook Food Using **Auto Cook** (for NN-ST756W)

1 Press Auto Cook Pad



Press the Auto Cook Pad until the desired food category appears in the display window.

2 Press Desired Serving / Weight Pad



Press the desired serving / weight Pad until the desired food Serving/Weight appears in the display window. (see below chart)

Pad	Food Category	Serving / Weight			
		1 tap	2 taps	3 taps	4 taps
Auto Cook	1. Frozen Reheat	250 g	450 g	650 g	850 g
	2. Dried Pasta	150 g	250 g	375 g	500 g
	3. Fresh Pasta	250 g	375 g	500 g	625 g
	4. Vegetables	120 g	180 g	250 g	370 g
	5. Frozen Vegetables	120 g	250 g	500 g	750 g
	6. Potatoes	250 g	370 g	500 g	900 g
	7. Legumes	1.0 cup	2.0 cup	3.0 cup	4.0 cup
	8. Rice	1.0 cup	1.5 cup	2.0 cup	2.5 cup
	9. Noodles	200 g	350 g	500 g	800 g
	10. Fish	120 g	250 g	370 g	500 g
	11. Curries	250 g	500 g	750 g	—
	12 Chicken Pieces	400 g	600 g	800 g	1000 g

3 Press



Cooking time appears in the Display Window and begins to count down.

* See Individual recipe chapters for hints and food types suitable for each Auto Cook food category.

To Use Recipe Prompting

Recipe Prompting

To Use Recipe Prompting

This feature helps you to cook by following the instructions given in the Display Window. The instructions for a total of 30 recipes are given (see following page).

NN-ST786W

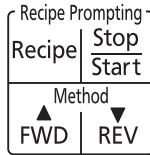

NN-ST756W

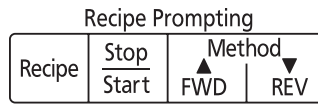

1 Press

Until the desired recipe appears in the Display Window.

For the previous recipe, press



Recipes are arranged alphabetically. The first time you use **Recipe Prompting** after plugging in your oven, the first recipe, **Beef Stroganoff**, will appear. The next time you press the **Recipe** pad, the last recipe you selected will be displayed.

Once you have selected a recipe,

2 Press



The first instruction will scroll across the Display Window.

Press for the next instruction. →



← Press for the previous instruction.

“ENJOY YOUR MEAL” appears in the Display Window at the end of each recipe.

HINTS WHILE USING *RECIPE PROMPTING*

<p>RecipePrompting</p>	<p>One tap: Stops scrolling of the Display Window. Two taps: Restarts scrolling of the Display Window. After you have programmed the recipe with micro power level and cooking time, press Start.</p>
<p>⊖ Stop/Reset</p> <p>or</p>	<ol style="list-style-type: none"> While instructions are in the Display Window, one tap will clear the Display Window and colon or time of day will appear in the Display Window. While setting power or time, previous instruction will appear in the Display Window by one tap. Two taps make the colon or time of day appear in the Display Window. While cooking, one tap stops the remaining cooking time counting down. The next instruction will start scrolling by two taps.
<p>⬢ Start</p> <p>or</p>	<p>Cooking will start by pressing this pad.</p>

To Use Recipe Prompting

Recipe Prompting

NOTE:

Throughout Recipe Prompting, the oven will instruct you to set the cooking time and power level at each stage of the recipe. Set the instructed power level and cooking time using the Micro Power pad and numbered Time pads. These settings are a guide only. If you wish to change, the oven can accept a different power level and cooking time.

For further information about cooking any of these recipes, refer to the recipe section.

The following recipes are programmed in Recipe Prompting:

Recipe	Page of Cook Book	Recipe	Page of Cook Book
Beef Stroganoff	22	Green Peppercorn Chicken	15
Cheese Sauce	43	Herbed Vegetables	26
Cheesy Mashed Potatoes	26	Honey Sesame Drumsticks	16
Chicken Cacciatore	15	Lemon Pepper Fish	12
Chicken Curry	17	Peach Crumble	35
Chicken Risotto	30	Potato and Leek Soup	7
Chilli Beef	22	Potato Bake	26
Chinese Beef and Vegetables	22	Pumpkin Soup	7
Chocolate Brownies	40	Rich Chocolate Sauce	43
Chocolate Fudge	40	Seasoned Roast Lamb	22
Cinnamon Poached Pears	41	Spaghetti Meat Sauce	22
Creamy Bacon Sauce	33	Speedy Nachos	9
Fragrant Coconut Rice	29	Sweet Berry Sauce	41
French Onion Beef Casserole	20	Tomato Vegetable Casserole	26
Garlic Prawns	11	Thai Vegetable Curry	26

INGREDIENT CONVERSION CHART

¼ cup	60 ml	¼ teaspoon	1 ml
⅓ cup	85 ml	½ teaspoon	2 ml
½ cup	125 ml	1 teaspoon	5 ml
⅔ cup	165 ml	2 teaspoons	10 ml
¾ cup	190 ml	3 teaspoons	15 ml
1 cup	250 ml	1 tablespoon	20 ml
1 ¼ cups	310 ml	1 ½ tbs	30 ml
1 ½ cups	375 ml	2 tbs	40 ml
2 cups	500 ml	3 tbs	60 ml
3 cups	750 ml	4 tablespoons	80 ml
3 ½ cups	875 ml		
4 cups	1 litre		
6 cups	1.5 litre		
8 cups	2 litre		

All recipes are tested using standard measurement that appear in the above chart.

Before Requesting Service

THESE THINGS ARE NORMAL

The oven causes interference with my TV.

Some radio and TV interference might occur when you cook with the microwave oven. This interference is similar to the interference caused by small appliances such as mixers, vacuums, hair dryers, etc. It does not indicate a problem with your oven.

Steam accumulates on the oven door and warm air comes from the oven vents.

During cooking, steam and warm air are given off from the food. Most of the steam and warm air are removed from the oven by the air which circulates in the oven cavity. However, some steam will condense on cooler surfaces such as the oven door. This is normal.

I accidentally ran my microwave oven without any food in it.

Running the oven empty for a short time will not damage the oven. However, we do not recommend this.

PROBLEM

POSSIBLE CAUSE

REMEDY

Oven will not turn on.



The oven is not plugged in securely.

Remove plug from outlet, wait 10 seconds and re-insert.

Circuit breaker or fuse is tripped or blown.

Reset external circuit breaker or replace external fuse.

There is a problem with the outlet.

Plug another appliance into the outlet to check if the outlet is working.

Oven will not start cooking.



The door is not closed completely.

Close the oven door securely.

Start was not pressed after programming.

Press **Start** Pad.

Another programme has already been entered into the oven.

Press **Stop/Reset** Pad to cancel the previous programme and programme again.

The programme has not been entered correctly.

Programme again according to the Operating Instructions.

Stop/Reset has been pressed accidentally.

Programme over again.

The word "Lock" appears in the display window.



The Child Lock was activated by pressing **Start** pad 3 times.

Deactivated Lock by pressing **Stop/Reset** pad 3 times.

The word "DEMO MODE"* appears on the screen.



Timer/Clock or **Clock** Pad has been pressed 3 times.

Deactivated mode by pressing **Timer/Clock** or **Clock** Pad 3 times.

When the oven is turning on, there is noise coming from the Glass Tray.



The Roller Ring and oven bottom are dirty.

Clean these parts according to "Care of Your Microwave Oven" (see next page).

* DEMO MODE is designed for retail store display. Cooking and other functions will not operate during the DEMO mode. If it seems there is a problem with the oven, contact an authorised Service Centre.

Care of Your Oven

BEFORE CLEANING:

Remove plug from outlet. If impossible, leave oven door open to prevent oven from accidentally turning on.

AFTER CLEANING:

Be sure to replace the Roller Ring and Glass Tray in the proper position and press **Stop/Reset** Pad to clear the Display Window.

Inside of the oven:

Wipe with a damp cloth. Mild detergent may be used if the oven gets very dirty. The use of harsh detergent or abrasives is not recommended.

Glass Tray:

Remove and wash in warm soapy water or in a dishwasher. If grease accumulates, clean with a non-abrasive nylon mesh scouring pad and a non-abrasive cleanser.

Outside oven surfaces and back vents.

To prevent overheating caused by blocked vents, clean periodically with damp cloth. To prevent damage to the operating parts inside the oven, water should not be allowed to seep into ventilation openings.

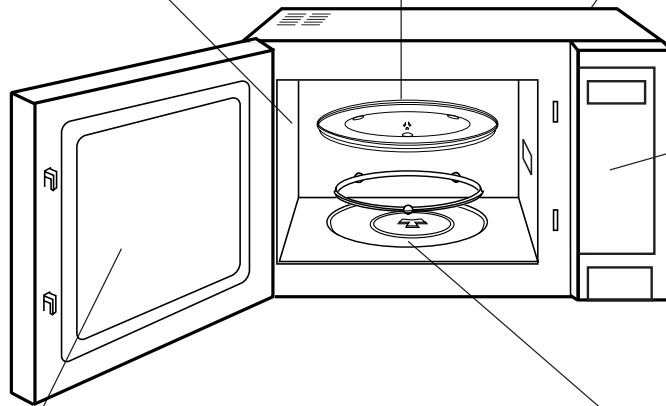

Control Panel:

•If it becomes wet, clean with a soft, dry cloth. Do not use harsh detergents or abrasives on the Control Panel.

Oven Door:

Wipe with a soft cloth when steam accumulates inside or around the outside of the oven door. This may occur when the microwave oven is operated under high humidity conditions and in no way indicates a malfunction of the unit or of microwave leakage.

Roller Ring and oven cavity floor:

Wipe the bottom surface of the oven with mild detergent water or window cleaner and dry. Roller Ring may be washed in mild soapy water or dishwasher. These areas should be kept clean to avoid excessive noise and scratching of painted surface .

Technical Specifications

	NN-ST786W	NN-ST756W
Power Supply:	230 - 240 V 50 Hz	
Power Consumption*:	1,150 W 5.1 A	
Power Requirement (Maximum):	1,950 W 8.6 A	
Cooking Power*:	1,100 W	
Outside Dimensions (H x W x D):	304 mm x 555 mm x 493 mm	
Oven Cavity Dimensions (H x W x D):	221.5 mm x 418 mm x 470 mm	
Operating Frequency:	2,450 MHz	
Uncrated Weight:	Approx. 14.3 kg	

* IEC Test Procedure
Specifications subject to change without notice.

Panasonic Technics

WARRANTY

1. The product is warranted for 12 months from the date of purchase. Subject to the conditions of this warranty Panasonic or its Authorised Service Centre will perform necessary service on the product without charge for parts or labour if, in the opinion of Panasonic, the product is found to be faulty within the warranty period.
2. This warranty only applies to products sold by Panasonic Australia or its Authorised Distributors or Dealers and only where the products are used and serviced within Australia or its territories. Warranty cover only applies to service carried out by a Panasonic Authorised Service Centre and only if valid proof of purchase is presented when warranty service is requested.
3. This warranty only applies if the product has been installed and used in accordance with the manufacturer's recommendations (as noted in the operating instructions) under normal use and reasonable care (in the opinion of Panasonic). The warranty covers normal domestic use only and does not cover damage, malfunction or failure resulting from use of incorrect voltages, incorrect installation, accident, misuse, neglect, build-up of dirt or dust, abuse, misadjustment of customer controls, mains supply problems, thunderstorm activity, infestation by insects or vermin, tampering or repair by unauthorised persons (including unauthorised alterations), exposure to abnormally corrosive conditions or any foreign object or matter having entered the product.
4. This warranty does not cover the following items unless the fault or defect being complained of existed at the time of purchase.
 - (a) Video or AudioTapes.
 - (b) Video or Audio Heads and Stylis resulting from wear and tear in normal use.
 - (c) Shaver Heads or Cutters.
 - (d) Cabinet parts.
 - (e) User replaceable Batteries.
 - (f) Thermal Paper, Toner/Ink Cartridges, Drums, Developer, Film (Ink/Ribbon), Film Cartridge, Printer Heads
 - (g) Microwave Oven cook plates.
5. If warranty service is required you should:
 - Telephone Panasonic's Customer Care Centre on 132600 for the name/address of the nearest Authorised Service Centre.
 - Provide a copy of your purchase receipt as proof of date of purchase.
 - Send or bring the product to a Panasonic Authorised Service Centre. Please note that freight to and / or from your nearest Authorised Service Centre must be arranged by you.
 - Note that home service is available for the following products in the major metropolitan areas of Australia or the normal operating areas of the nearest Authorised Service Centres:
 - Television Receivers (screen size greater than 39 cm)
 - Electronic Organs or Pianos
 - Microwave Ovens (convection only)
 - Whiteboard (except portable type)
6. The warranties hereby conferred do not extend to any costs associated with the delivery, handling, freighting or transportation of the product or any part thereof or replacement of and do not extend to any damage or loss occurring during, or associated with, transit.

Panasonic Authorised Service Centres are located in major metropolitan areas and most regional centres of Australia, however, coverage will vary dependant on product. For advice on exact Authorised Service Centre locations for your product, please telephone our Customer Care Centre on 132600.

Unless otherwise specified to the consumer the benefits conferred by this express warranty are additional to all other conditions, warranties, guarantees, rights and remedies expressed or implied by the Trade Practices Act 1974 and similar consumer protection provisions contained in legislation of the States and Territories and all other obligations and liabilities on the part of the manufacturer or supplier and nothing contained herein shall restrict or modify such rights, remedies, obligations or liabilities.

**THIS WARRANTY CARD AND THE PURCHASE DOCKET (OR SIMILAR PROOF OF PURCHASE)
SHOULD BE RETAINED BY THE CUSTOMER AT ALL TIMES**

**If you require assistance regarding warranty conditions or any other enquiries,
please contact the Panasonic Customer Care Centre**

By phone **132600** or via the website **www.panasonic.com.au**

Panasonic Australia Pty. Limited ACN 001 592 187 ABN 83 001 592 187

NEW SOUTH WALES
PO Box 505, Frenchs Forest, NSW 1640

WESTERN AUSTRALIA
PO Box 376, Welshpool, WA 6986

VICTORIA
Private Mail Bag 13, South Eastern Mail Centre, VIC 3176

QUEENSLAND
PO Box 5260, Albion, QLD 4010

SOUTH AUSTRALIA
PO Box 500, Hindmarsh, SA 5007

www.panasonic.com.au

Quick Guide to Operation

FOR ALL MODELS

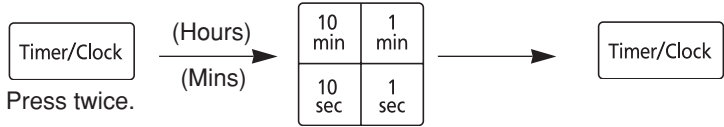
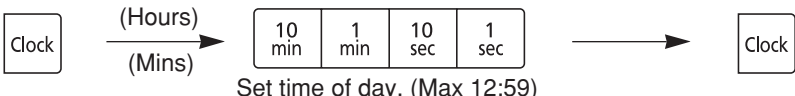
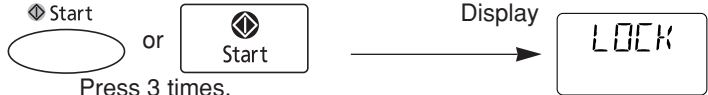
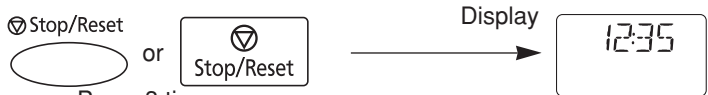
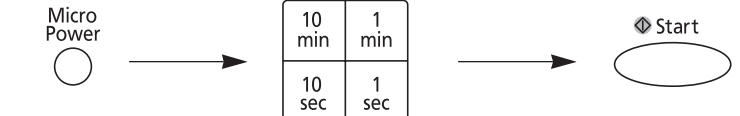
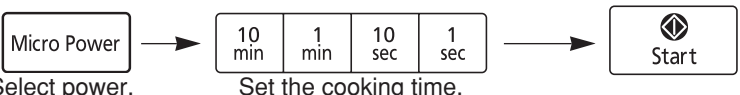
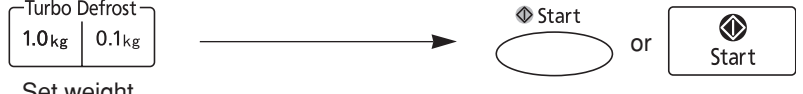
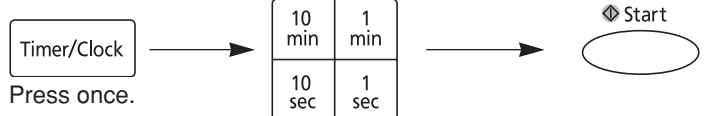
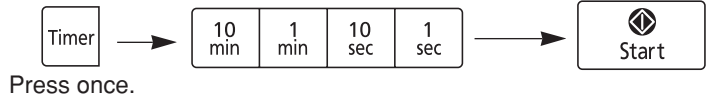
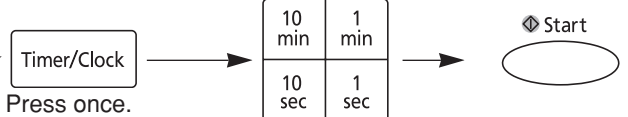
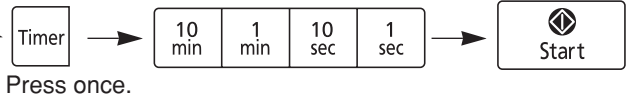
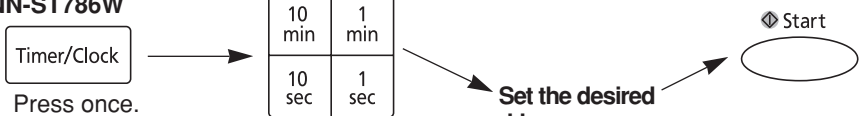
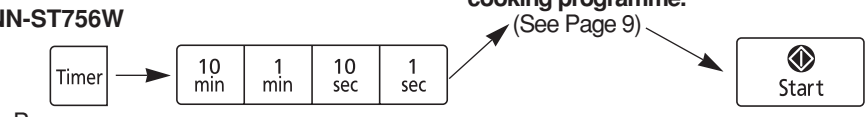

Feature	How to Operate
To Set Clock <small>(☞ page 10)</small>	<p>NN-ST786W</p>  <p>Press twice.</p> <p>NN-ST756W</p>  <p>Set time of day. (Max 12:59)</p>
To Set / Cancel Child Safety Lock <small>(☞ page 10)</small>	<p>To Set:</p>  <p>Press 3 times.</p> <p>To Cancel:</p>  <p>Press 3 times.</p>
To Cook / Reheat / Defrost by Micro Power and Time Setting <small>(☞ page 9)</small>	<p>NN-ST786W</p>  <p>NN-ST756W</p>  <p>Select power. Set the cooking time.</p>
To use Turbo Defrost Pad <small>(☞ page 12)</small>	 <p>Set weight.</p>
To Use as a Kitchen Timer <small>(☞ page 11)</small>	<p>NN-ST786W</p>  <p>Press once.</p> <p>NN-ST756W</p>  <p>Press once.</p>
To Set Standing Time <small>(☞ page 11)</small>	<p>NN-ST786W</p>  <p>Press once.</p> <p>NN-ST756W</p>  <p>Press once.</p>
To Set Delay Start <small>(☞ page 11)</small>	<p>NN-ST786W</p>  <p>Press once.</p> <p>NN-ST756W</p>  <p>Press once.</p> <p>Set the desired cooking programme. (See Page 9)</p>

Quick Guide to Operation

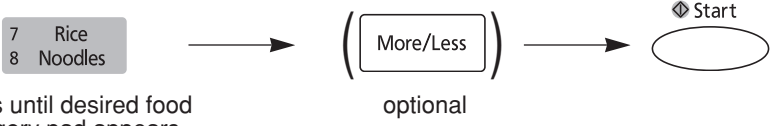
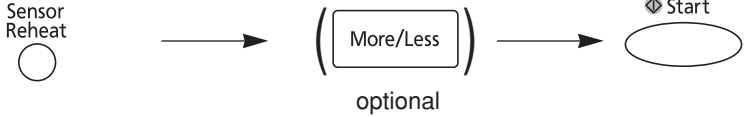
FOR NN-ST786W

Feature	How to Operate
To Cook using “Sensor Cook” Pads (S) <small>(see page 14)</small>	 <p>Press until desired food category pad appears.</p> <p>optional</p>
To Reheat using “Sensor Reheat” Pads <small>(see page 15)</small>	 <p>optional</p>

FOR NN-ST756W

Feature	How to Operate
To Cook using “Auto Cook” Pads (A) <small>(see page 17)</small>	 <p>Press to select the desired food category.</p> <p>Select serving size.</p>
To Reheat using “Auto Reheat” Pads <small>(see page 16)</small>	 <p>Press to select weight.</p>

Microwaves penetrate the surface of the food to a depth of about two to three centimetres and then the heat is gradually conducted in a random pattern. Some parts of food matter cook faster than others. Special microwave techniques are used to promote

fast and even cooking. Some of these techniques are similar to those used in conventional cooking, but because microwaves produce heat very quickly these following techniques are extremely important. It's a must for you to be familiar with the following tips.

Food Characteristics

Size and Quantity

Small portions cook faster than large portions. As you increase the quantity of food you put into the microwave oven, you must also increase your cooking time. The microwave oven has the same power regardless of quantity; thus the power is divided between more items and so it takes longer to cook.

As a general guide, if you double the quantity of food suggested in the recipe, add half the time suggested again.

Liquid Content

Low moisture foods take a shorter time to cook than foods with a lot of moisture.

Shape

Uniform sizes cook more evenly. To compensate for irregular shapes, place thin pieces towards the centre of the dish and thicker pieces towards the outer edge of the dish.

Bone and Fat

Bones conduct heat and cause the meat next to them to be heated more quickly. Large amounts of fat absorb microwave energy and the meat next to these areas may overcook.

Starting Temperature

Food which has been sitting at room temperature takes less time to cook than refrigerated or frozen food.

Density and Composition

Porous, airy foods (cakes and breads) take less time to cook than heavy compacted foods (meat and vegetables). Recipes high in fat and sugar content cook more quickly.

Key to Symbols Used in Recipes

Recipes displaying these symbols may be cooked using these features.

- **(S)** Sensor Cook / for NN-SD786S/NN-ST786W
- **[A]** Auto Cook / only for NN-ST756W
-  / for NN-SD786S/NN-ST786W

Techniques for Preparation

Timing

A range of cooking times is given in each recipe for two reasons. First, to allow for the uncontrollable differences in food shapes, starting temperatures and personal preferences. Secondly, these allow for the differences in electrical voltage input which changes during peak load periods. Always remember that it is easier to add time to undercooked food. Once the food is overcooked, nothing can be done. For each recipe, an approximate cooking time is given.

Stirring

Stirring is often necessary during microwave cooking. We have noted when stirring is helpful in the recipes. Always bring the outside edges towards the centre and the centre portions to the outside.

Rearranging or Turning

Some foods should be turned in the container during cooking. For example, because of the different thicknesses in the breast and back sections of poultry, it is a good idea to turn poultry over once to ensure more even cooking. Rearranging or turning over uneven shaped food in the dish should be done as suggested to ensure a satisfactory result. Rearrange small items such as chicken pieces, prawns, hamburger patties, steak or chops. Rearrange pieces from the centre to the edge of the dish.

Cooking in Layers

This microwave oven is not designed to cook more than 1 layer of food. Cooking in 2 layers may not always be successful, it takes longer and may be uneven. You can successfully reheat two dinner plates of food at one time but remember to increase the reheating time and use a microwave warming rack.

Piercing of Foods

Pierce the skin or membrane of foods when cooked whole in the microwave oven. This allows steam to escape. If the skin has not been pierced, food may burst.

Cured Meats

Cured meats may overcook in some areas due to the high concentration of salts used in the curing process. So take care when cooking different brands of bacon as cooking times may vary slightly.

Covering

Covering food minimizes the microwave cooking time.

Because microwave cooking is done with time and not direct heat, the rate of evaporation cannot be easily controlled. However, this can be corrected by using different materials to cover dishes. Plastic wrap is the best substitute for a lid as it creates a tighter seal and so it retains more heat and steam. Wax paper and paper towels hold the heat in but not the steam. These materials also prevent splattering. Use a paper towel, wax paper or no cover when steam is not needed for tenderizing.

Browning

Meats and poultry, when cooked longer than 10 to 15 minutes, will brown from their own fat. Foods cooked for shorter periods of time can be aided with the help of a browning sauce, worcestershire sauce or soy sauce. Simply brush one of these sauces over meat or poultry before cooking. Baked goods do not need long cooking times and therefore, do not brown. When cakes or cupcakes are iced, no one will notice the visual difference. For cakes or cupcakes, brown sugar can be used in the recipe in place of caster sugar or the surface can be sprinkled with dark spices before baking.

Standing Time

The moisture molecules continue to vibrate in the food when the microwave oven has turned itself off. After all, the molecules were vibrating at 2,450,000,000 times per second during cooking. So cooking continues even after the food is no longer being exposed to the microwaves whether in or outside your microwave oven.

Standing time refers to the time it takes (after the microwave time is completed) to allow the interior of the food to finish cooking.

The amount of standing time varies with the size and density of the food. In meat cookery, the internal temperature will rise between 5°C and 10°C if allowed to stand covered for ten to fifteen minutes. Casseroles and vegetables need shorter standing time, but this time is necessary to allow foods to complete cooking in the centre without overcooking on the edges.

The power level used in microwave cooking also determines the standing time. For example, when using a lower power level the standing time is shorter because of a lower concentration of heat in the food. Foods should always be kept covered while standing in order to retain the heat. If a longer standing time is required (while you cook another food to serve with the first, for instance), cover with aluminum foil.

Converting Your Favourite Conventional Recipes for Microwave Cooking

When adapting conventional recipes for microwave cooking time are reduced considerably.

For example, A chicken which takes 1 hour to cook in a moderate oven will take 15 to 20 minutes on P7 Power in your microwave oven.

Use similar microwave recipes to help you adapt conventional recipes. Remember, it is always best to undercook a recipe and then add an extra minute or two to finish it off.

Here are some other tips that may help:

- Reduce liquids in a conventional recipe by one half to two thirds, e.g. 1 cup (250 ml) should be reduced to $\frac{1}{2}$ cup (125 ml).
- Add more thickening such as flour or cornflour to sauces and gravies if you do not reduce the liquid.
- Reduce seasonings slightly in a recipe where ingredients do not have time to simmer by microwave.
- Do not salt meats, poultry or vegetables before cooking; otherwise, they will toughen and dry out.
- If one ingredient takes longer to cook than the others, pre-cook it in the microwave oven first. Onion, celery and potato are examples.
- When cooking meat or vegetables, omit any oil or fat that would have been used in a conventional recipe for browning.
- Reduce leavening agents for cakes by one quarter and increase liquids by one quarter.
- Biscuits require a stiff dough. Increase flour by about 20 percent. Substitute brown sugar for white sugar and use biscuit recipes that have dark spices or require icing. Because of the short cooking time, biscuits don't have time to brown. Chill dough for half an hour before baking. This produces a crisper biscuit. Bake biscuits on a glass tray lined with greaseproof paper.
- Since microwaves penetrate foods about two centimetres from the top, bottom and sides, mixtures in round shapes and rings cook more evenly. Corners receive more energy and may overcook.
- Items with a lot of water, such as rice and pasta, cook in about the same time as they would on a conventional stove. (Refer to **Rice** and **Pasta** chapter.)

Select recipes that convert easily to microwave cooking such as casseroles, stews, baked chicken, fish and vegetable dishes. The results from foods such as grilled meats, cooked souffles or two-crust pies could be less than satisfactory. Never attempt to deep fry in your microwave oven.

Menu Planning for Microwave Cooking

How to Keep Everything Hot at The Same Time

Plan your meals so that the food will not all need last minute cooking or attention at the same time. The special features of microwave cookery make it easy to serve meals with everything piping hot. Cooking of some foods may be interrupted while you start others, without harming the nutritional value or flavour of either.

A recipe which requires standing time can be microwaved first and another food cooked while it stands. Dishes prepared in advance can be reheated briefly before serving.

It does take some experience and time to cook with confidence. Microwaves are fast so you will have to do some experimenting. You might find you will use your conventional range in conjunction with your microwave oven. For example, while cooking the roast in the microwave oven, you can be cooking the vegetables and gravy on the range top. This can also be done the other way around. Prepare your meals as follows.

1. Firstly, cook the most dense item (roast or casserole). Drain and retain meat juice from joints then cover with foil.
2. Cook the potatoes, rice or pasta.
3. Cover with foil for standing.
4. Cook greens and other vegetables.
5. Cover with foil for standing.
6. Cook the gravy with the retained meat juices, stock and thickening.
7. Carve the roast and serve the vegetables and gravy.

While you are learning to plan meals, you may get a bit behind time. Don't worry. Dinner servings may be suitably reheated on P7, 1 to 2 minutes per serving.

If you prefer not to use foil, cover food with saucepan lids. A metal lid will retain the heat for at least 15 minutes.

Meanwhile, how can you cook all the vegetables at the same time? Simply place potatoes and pumpkin in one dish and less dense vegetables such as broccoli, cabbage, cauliflower, beans and peas in another. Sprinkle greens with water. Cover with a lid or plastic wrap. Cook on P10 for cooking times refer to vegetable cooking chart on page 23.

Remember, if you increase the quantity of vegetables, increase the cooking time. Fresh and frozen vegetables can be mixed on a vegetable platter, but remember the latter are not as dense as fresh vegetables, as they have been blanched before freezing.

If vegetables are cut to a similar size, they can be cooked in separate ramekins or small dishes at the same time.

Increasing & Decreasing Recipes

Increasing

- To increase a recipe from 4 to 6 servings, increase each ingredient listed by half.
- To increase a recipe from 4 to 8 servings, double each ingredient listed.
- For larger quantities of a recipe, a large dish should be used. Make sure that the dish is deep enough to prevent the recipe from boiling over during cooking.
- Make sure to cover, stir or rearrange food as directed in the recipe and always check the food during cooking.
- Increase standing times by 5 minutes per 500g.
- Use the same Power Level recommended in the original recipe.
- Increase the cooking times by: $\frac{1}{3}$ of original cooking time for 6 servings; and an extra $\frac{1}{2}$ of original cooking time for 8 servings.

Decreasing

- To decrease a recipe from 4 to 2 servings, decrease each ingredient listed by half.
- For small quantities, a small dish should be used. Make sure that the dish is large enough to prevent the recipe from boiling over during cooking.
- Use the same Power Level recommended in the original recipe.
- Decrease the cooking times by $\frac{1}{2}$ to $\frac{2}{3}$ of the original cooking time.

Cooking for One

- To decrease a recipe from 4 to 1 serving, quarter each ingredient listed.
- A smaller dish should be used, making sure that the dish is still large enough to prevent the recipe from boiling over.
- Use the same Power Level recommended in the original recipe.
- Quarter the original cooking times, then add extra time, if needed.
- Make sure to cover, stir or rearrange food as directed in original recipe and always check the food during cooking.

Converting Recipes from Other Sources

When the recipe is written with a wattage different than your oven, adjust the cooking time by approximately 10% per 100 watts, e.g. 6 minutes would be adjusted by 36 seconds. Alternately, adjust the power level by one level. If your wattage is higher than the recipe: (1) Adjust time downward or (2) Adjust power level downward. If your wattage is lower than the recipe: (1) adjust time upward or (2) adjust power level upward (when possible).

One of the most common uses for a microwave oven is to reheat food. Your Panasonic microwave allows you to either reheat by placing food into the oven and you choose the micro power level and length of heating time or you may reheat automatically by using the SENSOR REHEAT buttons on your microwave. Following are some directions for reheating pre-cooked foods from either frozen refrigerator temperature or room temperature.

General rules for reheating foods by Micro Power

- Many convenience foods contain heating instructions on the packaging. It is best to follow these instructions, being sure to check the wattage of the oven they used and adjust the cooking time if necessary (decrease cooking time by 10% for every 100watts more powerful your oven is)
 - If package directions are not available, following the recommendations in the charts on the following pages.
 - All foods must be pre-cooked; raw foods will not cook through during reheating times and if consumed may cause illness.
 - Do not reheat in foil containers, cans or plastic containers as incorrect heating times will result. Place foods into microwave safe bowls or dinner - plate before heating.
 - Most foods can be heated on P10 but consider if the food is delicate in structure like baked custard or you have a large quantity, a lower power level for slightly longer may be gentler.
 - Cover foods with plastic wrap if you require a steamed effect or leave uncovered for a dryer surface e.g. Crumbed foods
- Note:** when cooking by Sensor Cook all food must be covered.
- Stir or re-arrange foods during heating as this will help food heat evenly. Stir after heating and let stand for 2 to 3 minutes. Check temperatures before adding extra heating time and ensure food is hot. If food is not heated enough, consumption may cause illness.

Reheating by Sensor Cook (S) (125 g - 1.0 kg)

- Reheating by Sensor is suitable for pre-cooked foods. There is a setting for frozen, and refrigerator temperature or room temperature foods. It is suitable for casseroles, plated meals, soup, stews, pasta dishes (except lasagne) and canned foods.
- Do not reheat bread or pastry products, raw uncooked food or beverages on Sensor Reheat.
- Foods greater than 1 kg or smaller than 125 g should be cooked by micro power and time.
- Follow general directions for heating as above.
- Cover foods securely with plastic wrap or a fitted lid, which does not snap seal.
- Halfway through the cooking time, the oven will 'beep' and prompt you to stir/rearrange the food. There is no need to recover if not required.
- After heating, stir the food, check it is hot and allow standing for 2 to 3 minutes.

To Operate: Press  then Press **Start**.

NN-ST786W

Reheating by Auto Cook (250 g - 850 g)

- Foods weighting less than 200 g and more than 900 g should be heated by micro power and time.
- Auto Cook has 2 settings one for heating frozen foods and one for heating foods from refrigerator or room temperature.
- Suitable foods include casseroles, plated dinners, soups, stews, pasta dishes, (except lasagne) and canned foods.
- Do not reheat bread or pastry items, raw or uncooked foods or beverages.
- Cover foods loosely with plastic wrap or a lid, which does not snap seal.
- During the cooking time, the oven will 'beep' and prompt you to rearrange or stir. At the end of cooking time, stir the food, check it is hot and allow standing 2 to 3 minutes.

To Operate: Press. 
 NN-ST756W

or

 1. Frozen Reheat,



Select the **servicing / weight** pad, then Press **Start**.

Reheating by Micro Power - Frozen Pre-cooked Foods

FROZEN ITEM (Pre-cooked)	POWER	TIME (in minutes)	SPECIAL INSTRUCTIONS
BREAD & BAKED PRODUCT			
Bread 1 slice	P7	10 - 15 sec	Do not let bread get hot, or it will become rubbery and dry out. Remove whole loaf from original wrapper. Place on paper towel to absorb moisture.
1 loaf	P7	1 - 3	
6 rolls	P6	1 - 2	
Cheesecake (450g)	P3	5 - 7	Remove from container. Defrost on plate.
Muffins - 4 (400 g)	P7	1½ - 2	Place onto paper towel lined plate.
Scones - 6 (400 g)	P6	1½ - 2	Defrost on paper lined plate. Stand 2 minutes.
PIES			
Fruit Pie (600 g)	P3 then P7	5 - 7 5 - 7	Remove from foil container and place uncovered into a pie dish.
Meat Pie (175g)	P7	3 - 4	Place onto paper towel lined plate.
Pizza (350 g)	P10	5 - 7	Remove from package and place onto paper towel or follow manufacturer's instructions.
FROZEN MEAL			
Fish in Sauce (200 g)	P5	5 - 7	Pierce corner of bag. Heat on a plate.
Frozen Casserole (500g)	P7	6 - 8	Pierce pouch. Heat on a plate or bowl.
Lasagne (500 g)	P9	11 - 13	Remove from foil container, place into serving dish.
Plated style dinner (320 g)	P5	8 - 10	Remove foil cover and replace with plastic wrap.
Vegetables & Sauce (in the bag) (500 g)	P7	6 - 8	Pierce corner of bag. Heat on a plate.
MISCELLANEOUS			
Chicken Pieces (500 g)	P7	5 - 7	Place onto paper towel lined plate.
Chicken Nuggets(12)	P7	3 - 4	
Croissants - 4 (200 g)	P3	1 - 1½	Place onto paper towel lined plate.
Fish Fingers - 8 (200 g)	P3 then P10	2 - 4 2 - 3	Place onto paper towel lined plate.
Sausage Rolls (225 g)	P5	2 - 3	

Reheat

IMPORTANT POINTS TO CONSIDER WHEN REHEATING COLD FOODS

STARTING TEMPERATURE —

Foods taken from the refrigerator will take longer to reheat than foods from room temperature.

Quantity —

One serving heats faster than several servings. When heating large quantities, stir food to ensure even heating. It is quicker to heat individual plates of food than large quantities in a casserole dish.

Plated Dinners —

Arrange foods with the most dense items towards the outside of the plate. Cover meats with sauces/gravies if desired, spread out mashed potatoes or rice so it heats more evenly. When assembling plates of leftover foods, use foods which have a similar starting temperature.

Covering Foods —

Most foods need to be covered with one sheet of absorbent paper towel to hold in the heat and prevent splattering without steaming. When more moisture is desired, cover with plastic wrap.

Heating —

Reheating is usually done on P10, however, if food has a more delicate texture, like a baked custard, a lower power setting should be used. P7 for a little longer will be gentler on the food. An average plate of food would generally take 1 to 3 minutes to heat depending on the density of the food. Place it in for the minimum time and add extra heating time if required.

Ensure food is hot by feeling the bottom of the plate in the centre. If the plate is cool, food may be warm but will lose heat quickly as the plate will absorb the heat and taste cold when served.

If food is not heated enough, consumption may cause illness.

Elevation —

Elevate pastries and breads on a small plastic rack with paper towel under the food to prevent it from becoming soggy.

Caution:

Pastry items which have a filling that is high in fat, sugar or moisture will become hotter in the centre and the pastry may only feel warm. Ensure you allow it to stand for several minutes before eating.

IMPORTANT POINTS TO CONSIDER WHEN REHEATING FOODS FROM THE FREEZER

VOLUME —

The greater the volume and the more dense the item, the longer it takes to reheat. E.g. frozen cake will take less time than frozen casserole.

LARGE VOLUME —

Large, dense, frozen precooked foods are best thawed on defrost until icy in the centre then heated on P7. This prevents overcooking of the edges. Stirring is often needed to distribute heat evenly.

Commercial frozen foods —

These foods should be removed from their foil containers if possible and placed into suitable microwave safe containers. If a foil container is used in the microwave oven it shouldn't be more than 4 cm high and must not touch the interior of the microwave oven. Remove the cover from the tray and replace with paper towel or plastic wrap to prevent splattering.

Foods to be served at room temperature —

For best results, defrost for a short time and allow to stand to complete thawing, e.g. frozen cake.

Vacuum sealed pouches —

Pierce pouches, bags before heating to allow steam to escape. This prevents bursting.

Containers —

Use dishes about the same volume of the food or slightly larger to allow for stirring. Remove or release snap seal lids otherwise they will pop during heating and may disfigure.

Pies and pastries —

Pies and pastries that contain raw pastry and filling cannot be cooked in the microwave oven. Pre-cooked products can be thawed and heated. Place them on a sheet of paper towel and elevate on plastic rack for best results. For added crispness place under the grill or in a hot oven for few minutes. Pastry items can become tough and rubbery if overheated, remember to allow 5 minutes standing then test before adding extra heating time.

PUMPKIN SOUP

Serves: 4

Recipe Prompting

Ingredients:

1 kg	pumpkin, chopped and peeled
1	onion, diced
2 cups	chicken stock
1 teaspoon	curry powder
	pepper

Method:

Place pumpkin and onion in 2-litre casserole dish. Cover and cook on P10 for 12 minutes. Add chicken stock, curry powder and pepper. Cook on P10 for 10 minutes. Cool slightly. Purée pumpkin and liquid in a blender or food processor. Pour into individual serving dishes and garnish with chives.

SHORT AND LONG SOUP

Serves: 4

Ingredients:

200 g	fresh singapore noodles
12 (200 g)	frozen mini dim sims
4	green onions, sliced
1 litre	chicken stock
1 teaspoon	crushed garlic
½ teaspoon	chopped ginger
2 tablespoons	soy sauce
1	chicken breast, cooked and sliced
4	baby bok choy, quartered
1 cup	bean sprouts
2 tablespoons	dried onion (optional)

Method:

Place all ingredients except bok choy and bean sprouts in a 4 litre casserole dish and cook on P10 for 10 minutes. Add bok choy and cook on P10 for 2 minutes. Serve in individual bowls topped with bean sprouts and onion.

Hints:

To cook 1 double chicken breast. Place onto a dinner plate. Cover and cook on P7 for 8 to 10 minutes.

Hints:

To reheat a single portion of soup. Place in a microwave safe dish and cook on P7 for 2 to 3 minutes. Stir and serve.



Pumpkin Soup

TOMATO BACON SOUP

Serves: 4 to 6

Ingredients:

4	bacon rashers, chopped
1	onion, chopped
1 (840 g)	can tomatoes
2 tablespoons	tomato paste
2 cups	chicken stock
1 teaspoon	oregano
	pepper

Method:

Place bacon and onion in 4-litre casserole dish. Cook on P10 for 3 minutes. Add remaining ingredients and stir. Cook on P10 for 16 to 18 minutes, stirring once during cooking. Purée in food processor or blender and serve in individual soup bowls.

POTATO AND LEEK SOUP

Serves: 4 to 6

Recipe Prompting

Ingredients:

800 g	potatoes, peeled and diced
1½ cups	thinly sliced leeks
2 teaspoons	fresh thyme
	pepper
2 cups	chicken stock
150 ml	cream

Method:

Place potatoes, leeks, thyme and pepper in 4-litre casserole dish. Cover and cook on P10 for 8 to 10 minutes. Stir in chicken stock. Cover and cook on P10 for 14 to 16 minutes. Purée soup mixture. Add cream, stir and serve hot or cold in individual bowls.

PEA AND HAM SOUP

Serves: 6

Ingredients:

2½ cups	green split peas
850 g	smoked ham hock
1	medium onion, chopped
1 tablespoon	thyme leaves
1	bay leaf
6 cups	chicken stock
½ cup	frozen peas

Method:

Wash split peas and place in a 2-litre bowl with 1-litre of water. Cover and allow soaking for 8 hours or overnight. Remove rind from ham hock and discard. Cut meat away from the bone and roughly chop. Reserve bone. Drain peas and place into a 5-litre microwave safe dish. Add ham bone, chopped ham, onion, thyme, bay leaf and chicken stock. Cook uncovered on P10 for 15 minutes. Reduce power to P6 and cook for 15 minutes. Skim top of soup and cook on P6 for a further 30 minutes. Remove ham bone and bay leaf and stir in frozen peas. Cook on P6 for 10 minutes. Blend half the soup and return to the bowl, stirring through the remaining soup. Serve hot with crusty bread.

Tip:

Substitute 500 g bacon bones and 250 g of diced bacon rashers for the ham hock. Do not add salt when cooking lentils or pulses, as they will toughen. Add salt after cooking if desired.

CHICKEN AND PRAWN LAKSA

Serves: 4

Ingredients:

Soup:	
2 tablespoons	laksa paste
400 ml	coconut milk
1 litre	chicken stock
1 tablespoon	soy sauce
	fresh ground black pepper
Laksa:	
250 g	rice noodles
8 cups	boiling water
	leaves from 1 bunch of coriander
4	small red chillies, seeds removed and finely chopped
½ cup	bean sprouts
4	lime wedges
1 tablespoon	peanut oil
400 g	cooked chicken tenderloins, sliced
12	green king prawns, peeled

Method:

Soup: Place the laksa paste, coconut milk, stock, soy sauce and pepper into a 3-litre dish and cook covered on P10 for 8 to 10 minutes.

Laksa:

Place the noodles and water in a 4 litre dish. Cover and cook on P10 for 2 to 3 minutes, stirring halfway through. Drain well and divide between 4 deep bowls. Place the coriander, chillies, bean sprouts and lime on top. Place the peanut oil and prawns in a 1-litre dish and cook on P7 for 3 to 5 minutes, stirring halfway through. Add the chicken and prawns to each individual bowl and set aside.

To serve:

Heat soup on P10 for 2 minutes. Pour the hot soup over the ingredients in the 4 bowls and serve.



Potato and Corn Soup

POTATO AND CORN SOUP

Serves: 6 to 8

Ingredients:

6	rashers bacon, chopped
1	onion, thinly sliced
500 g	potatoes, peeled and diced
4 cups	chicken stock
1 (420 g)	can creamed corn
2 tablespoons	flour, mixed with a little stock
½ teaspoon	thyme
	salt and pepper

Method:

Place bacon in a 4-litre dish. Cook on P10 for 2 to 3 minutes. Remove bacon from dish and set aside. Add onion and potatoes to dish and cook on P10 for 8 to 10 minutes. Add stock and cook on P10 for a further 8 to 10 minutes. Blend flour with 2 tablespoons of stock and add to dish with corn, thyme and bacon. Cook on P10 for 4 to 5 minutes. Stir halfway through cooking. Season with salt and pepper.

SWEET POTATO AND CORIANDER SOUP

Serves: 4 to 6

Ingredients:

1	onion, diced
1 teaspoon	crushed garlic
1 teaspoon	crushed chilli
1 teaspoon	chopped ginger
1 kg	sweet potato, peeled and chopped
½ teaspoon	cumin
500 ml	chicken stock
200 ml	coconut milk
1 tablespoon	chopped coriander

Method:

Place onion, garlic chilli, ginger, and sweet potato into a 4-litre bowl. Cook covered on P10 for 10-12 minutes, stirring halfway through cooking. Stir in cumin, chicken stock and coconut milk. Cook on P10 for 10-12 minutes, stirring halfway through cooking. Add coriander and stir. Allow to cool slightly then puree in a blender or food processor. Serve topped with extra coriander and chilli.

ROASTED NUTS

Serves: 2 to 4

Ingredients:

1 cup (150 g) raw peanuts (with or without skins, and unsalted)
 1 teaspoon vegetable oil
 salt to taste

Method:

Place peanuts in a single layer on a pie plate. Drizzle nuts with oil and sprinkle with salt. Cook on P10 for 4 to 6 minutes, stirring every 2 minutes during cooking, until golden brown. Stir well. Serve hot or cold in a small bowl.

SPEEDY NACHOS

Serves: 2 to 4

*Recipe Prompting***Ingredients:**

1 (310 g) can red kidney beans, drained
 1 cup chilli salsa
 200 g packet corn chips
 1 cup grated cheese

Method:

Mix kidney beans and salsa in a 1-litre dish. Place corn chips in the base of a flat dish. Pour sauce over beans and top with grated cheese. Cook on P10 for 4 to 5 minutes.

Note: Chilli salsa can be substituted with your favourite tomato relish.

NUTS AND BOLTS

Serves: 6 to 8

Ingredients:

80 g butter
 2 teaspoons curry powder
 2 tablespoons worcestershire sauce
 1/2 teaspoon salt
 1/4 teaspoon garlic powder
 100 g packet mixed rice crackers
 100 g fried noodles
 200 g salted peanuts
 125 g packet pretzel sticks
 1/2 cup Nutri-Grain

Method:

Place butter, curry, worcestershire sauce, salt and garlic powder in a 3-litre casserole dish. Cook on P10 for 1 to 2 minutes. Add remaining ingredients, mix well and cook on P10 for 4 to 5 minutes. Stir twice during cooking. Allow to cool. Place in a bowl and serve with drinks. Store in an airtight container once cool.

HINT:**TO MAKE CROUTONS:**

Remove crusts from 3 slices of bread and cut into cubes. Place in a pyrex bowl with 1 tablespoon of butter and cook on P10 for 2 to 3 minutes.

HINT:**TO REHEAT A CROISSANT:**

Wrap in paper towel and place on a dinner plate, cook on P10 for 15 to 30 seconds.

NACHOS SUPREME

Serves: 4 to 6

Ingredients:

500 g topside mince
 35 g packet taco seasoning mix
 1/3 cup tomato paste
 1 teaspoon Mexican chilli powder
 1(310 g) can red kidney beans, mashed in liquid
 180 g packet corn chips
 1 avocado
 1/2 cup sour cream
 1/2 cup grated cheese
 paprika

Method:

Place meat in a 2-litre dish. Cover and cook on P7 for 6 minutes stirring halfway through cooking. Mix with fork, breaking up any large pieces of meat. Add taco mix, tomato paste, chilli powder and kidney beans. Cook on P7 for further 10 minutes, stirring halfway through cooking. Place corn chips in a 3-litre microwave suitable serving dish. Pile meat sauce in the centre. In a small bowl, mash avocado and mix in sour cream. Spoon this mixture over meat sauce and top with grated cheese. Sprinkle with paprika. Heat on P7 for 3 to 4 minutes.

STUFFED POTATOES

Serve: 4

Ingredients:

4 (700 g) potatoes, unpeeled

Method:

Pierce the skin of each potato several times with a fork. Place potatoes evenly around a microwave safe dinner plate. Cook on P10 for 8 to 10 minutes. Set aside to cool slightly. Cut tops off potatoes and reserve. Scoop out potato flesh leaving a 1 cm thick shell. Mash potato flesh and mix with your choice of filling. Pile back into potato shell. Replace top and heat potatoes on P10 for 2 minutes.

Filling:**Corn & bacon**

1 rasher bacon, finely chopped
 125 g creamed corn
 1/4 cup grated cheddar cheese
 1 green onion, finely sliced

Method:

Place bacon onto a microwave safe dinner plate. Cover with paper towel and cook on P10 for 1 minute. Mix with remaining ingredients.

Tomato pesto

1/2 cup spreadable cream cheese
 1/2 cup chopped sun-dried tomatoes
 2 tablespoons pinenuts, roasted
 2 tablespoons grated Parmesan cheese
 2 tablespoons chopped basil

Method:

Mix together all ingredients.

Cooking Fish and Shellfish by Micro Power

Clean fish before starting the recipe. Arrange fish in a single layer, overlap thin fillet ends to prevent overcooking. Prawns and scallops should be placed in a single layer.

Cover dish with plastic wrap. Cook on the power level and the minimum time recommended in the chart below. Halfway through cooking rearrange or stir prawns, fish fillets or scallops.

Cooking Fish and Shellfish by Micro Power

FISH OR SHELLFISH	AMOUNT	POWER	APPROX. COOKING TIME (in minutes)
Fish Fillets	500 g	P4	8 to 10
Scallops (sea)	500 g	P4	6 to 8
Green Prawns medium size (shelled and cleaned)	500 g	P4	7 to 9
Whole Fish (stuffed or unstuffed)	500 g to 600 g	P4	7 to 10

Directions for cooking fish by Sensor (S) / Auto Cook

- **Minimum Weight 120 g / Maximum Weight 500 g**
- Suitable for cooking whole fish and fish fillets.
- Select fish suitable for microwave cooking and place in a single layer in a shallow dish, with skin-side down.
- Add butter, spices, herbs, or lemon juice to flavour.
- Overlap thin edges of fillets to prevent overcooking.
- Shield the eye and tail area of whole fish with small amounts of aluminum foil to prevent overcooking.
- Cover dish securely with plastic wrap or fitted lid that does not snap seal.
- During the cooking time, the oven will 'beep' and prompt you to turn over and rearrange.
- Allow large amounts of fish to stand for 3 to 5 minutes after cooking before serving.

To Operate for Sensor Cook:

Press **Fish**, then **Start**.

To operate for Auto Cook:

Select **Auto Cook** to **Fish**. Select the serving / weight, then press **Start**.

GINGERED WHOLE FISH (S)

Serves: 2

Ingredients:

1 (700 g)	whole bream, cleaned
1 tablespoon	sweet sherry
¼ cup	soy sauce
1 teaspoon	minced ginger
3	green onions, sliced
1 tablespoon	peanut oil

Method:

Place fish in a shallow casserole dish. Combine sherry, soy sauce, minced ginger, spring onions and peanut oil in a 1-litre jug. Pour sauce mixture over fish. Cover and cook on P4 for 4 to 5 minutes. Turn over and re-cover. Cook on P4 for 4 to 6 minutes.

To cook by Sensor Cook:

Prepare as above. Cover with plastic wrap. Select **Fish**, then **Start**.

FISH PIE

Serves: 4

Ingredients:

500 g	new potatoes, unpeeled
500 g	marinara mix or mixed fish
½	onion
1	bay leaf
250 ml	milk
2 tablespoons	butter
2 tablespoons	flour
½ cup	milk, extra
2	hard-boiled eggs, roughly chopped
2 tablespoons	chopped parsley
½ cup	grated cheese
1 teaspoon	paprika

Method:

Wash potatoes and pierce skins with a fork, place on a paper towel lined plate. Cook on P7 for 8 to 10 minutes. Set aside. In a 3-litre casserole dish combine fish, onion, bay leaf and milk. Cook on P6 for 4 to 6 minutes, stirring halfway through cooking. Strain and reserve milk, discard onion and bay leaf. Place butter in a 1-litre jug and cook on P10 for 30 to 60 seconds, stir in flour and slowly whisk in reserved milk. Cook on P10 for 2 to 3 minutes, stirring halfway through cooking. Stir in extra milk, eggs, parsley and fish cook on P7 for 1 to 2 minutes. Pour into a shallow casserole dish. Slice potatoes and layer over fish mixture. Sprinkle with grated cheese and paprika. Cook on P10 for 4 to 6 minutes.

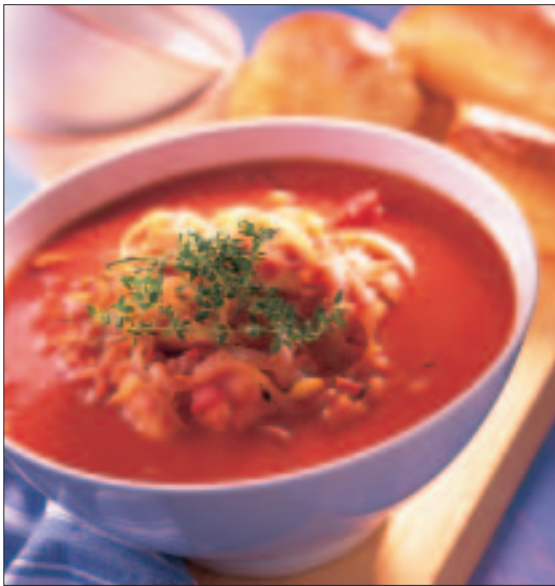

Bouillabaisse

BOUILLABAISSE

Serves: 4 to 6

Ingredients:

2 tablespoons	olive oil
2	onions, sliced
1	large leek, sliced
4	cloves garlic, crushed
425 g	can tomato pieces
1/2 cup	tomato paste
4 cups	hot fish stock
1/3 cup	dry white wine
1 tablespoon	fresh thyme leaves
1/2 teaspoon	saffron powder
1 teaspoon	chilli powder
	freshly ground black pepper
	salt
500 g	firm fish fillets, chopped
500 g	green prawn meat, de-veined

Method:

Place oil, onions, leek and garlic in a 4 litre dish. Cover and cook on P10 for 6 to 8 minutes. Stir halfway through cooking. Add tomatoes, tomato paste, fish stock, wine, thyme, saffron, and chilli powder. Season with salt and pepper. Cook on P10 for 12 minutes. Add fish fillets and prawns. Cook on P10 for 7 to 8 minutes or until seafood is cooked. Serve garnished with fresh thyme.

Noise

When cooking fish, popping sounds may be heard. This is due to moisture trapped between the flesh, particularly with oily fish such as salmon and mackerel. This can be minimised when cooking if the skin and flesh is pierced several times with a skewer.

SALMON MORNAY

Serves: 4

Ingredients:

40 g	butter
1	onion, diced
1/4 cup	flour
1 tablespoon	fresh parsley, chopped
	pepper
1/2 teaspoon	prepared mustard
1 1/2 cups	milk
1 (440 g)	can salmon, de-boned
3/4 cup	fresh bread crumbs
1/3 cup	grated cheese

Method:

Place butter and onion in a 4-cup jug. Cook on P10 for 1 minute. Add flour and cook on P10 for 1 minute. Add parsley, pepper, mustard and gradually blend in milk. Cook on P10 for 2 to 3 minutes, stir halfway through cooking. Lightly mix through salmon and liquid into sauce. Pour into serving dish and top with bread crumbs and cheese. Cook for further 4 to 5 minutes on P10 power.

GARLIC PRAWNS

Serves: 2

Ingredients:

60 g	butter
1 teaspoon	minced garlic
1 tablespoon	lemon juice
1 tablespoon	chopped parsley
500 g	peeled green prawns

Recipe Prompting

Method:

Place butter and garlic in a 1-litre dish and cook on P10 for 30 to 50 seconds. Add lemon juice, parsley and prawns. Cook on P6 for 5 to 7 minutes, stirring halfway through cooking. Serve in individual ramekins.

MALAY COCONUT FISH

Serves: 4

Ingredients:

1 (400 ml)	can coconut milk
1 tablespoon	chilli sauce
1	lime zested
5 cm piece	peeled ginger, finely chopped
1 tablespoon	garam masala
1 tablespoon	fish sauce
2 tablespoons	brown sugar
800 g	fish fillets, halved
1/4 cup	fresh coriander leaves

Method:

Mix coconut milk, chilli sauce, lime rind, ginger, garam masala, fish sauce and brown sugar in a 2-litre dish. Cover and cook on P10 for 8 minutes, stir halfway through. Add fish, ensuring all surfaces are coated well. Cover and cook on P5 for 6 to 7 minutes, turning fish halfway through cooking. Allow to stand for 5 minutes. Top with coriander leaves.

TOMATO BASIL MUSSELS

Serves: 4

Ingredients:

1 kg	fresh mussels
¼ cup	water
1 tablespoon	olive oil
1	leek, sliced
1	clove garlic, crushed
1 (425 g)	can tomato pieces
1 tablespoon	tomato paste
½ teaspoon	oregano
2 tablespoons	chopped fresh basil
	freshly ground black pepper

Method:

Place mussels and water into a bowl. Cover and cook on P7 for 4 to 6 minutes. Set aside. Place oil, leeks and garlic into a 3-litre dish. Cook on P10 for 2 minutes. Stir well, add tomato, tomato paste, oregano, basil and pepper. Mix well. Cook on P10 for 3 to 4 minutes. Add mussels. Cover and cook on P10 for 2 to 3 minutes. Serve immediately.

SALMON STEAKS WITH LIME BUTTER (S) 

Serves: 4

Ingredients:

60 g	butter
1	clove garlic, crushed
1 teaspoon	grated fresh ginger
1 teaspoon	grated lime rind
2 tablespoons	lime juice
½ teaspoon	sugar
500 g	salmon, steaks

Method:

Place butter, garlic, ginger, lime rind, juice and sugar in a shallow dish. Cook on P7 for 1 to 2 minutes. Stir halfway through cooking. Add salmon steaks and coat with sauce. Cover and cook on P5 for 5 to 7 minutes. Stand for 2 to 3 minutes before serving.

To cook by Sensor Cook / Auto Cook:

Prepare as above. Cover with plastic wrap. Refer to direction on page 10.

LEMON PEPPER FISH (S)

Serves: 2

**Ingredients:**

300 g	fish fillets
¼ cup	lemon juice

Method:

Place fish, lemon juice and cracked black pepper in a 1-litre casserole dish. Cook on P6 for 4 to 6 minutes. Let stand for 3 minutes before serving.

To cook by Sensor Cook:

Prepare as above. Cover with plastic wrap. Select **Fish**, then **Start**.



Seafood Marinara

For fish with a strong odour, eliminate the smell after cooking by placing 600 ml of boiling water and 1 slice lemon in a large bowl, cook on P10 for 10 mins. Wipe out oven with a dry cloth.

SEAFOOD MARINARA

Serves: 4

Ingredients:

750 g	marinara mix
2 tablespoons	butter
1	clove garlic, crushed
2	tomatoes, peeled and chopped
1 tablespoon	tomato paste
¼ cup	white wine
1 teaspoon	basil
	pepper
	chopped parsley

Method:

Place marinara mix into a 2-litre casserole dish. Set aside. Place butter and garlic in 1-litre casserole dish. Cook on P7 for 1 minute. Add remaining ingredients (except seafood), to dish and cook on P10 for 5 minutes. Purée tomato mixture in blender or food processor and pour over seafood. Cook on P6 for 7 to 9 minutes. Stand for 5 minutes. Serve with pasta.

OYSTERS KILPATRICK

Makes: 12

Ingredients:

2 rashers	bacon finely chopped
1 tablespoon	worcestershire sauce
2 teaspoons	lemon juice
1 tablespoon	barbecue sauce
12	oysters in shell

Method:

Spread bacon on a dinner plate. Cover with paper towel and cook on P10 for 1 to 2 minutes. Mix together worcestershire sauce, lemon juice and barbecue sauce. Place oysters in shell evenly around dinner plate and sprinkle with bacon mixture. Pour some sauce mixture over each oyster. Cook on P10 for 1 to 1½ minutes. Serve with drinks or as an entree.

Cooking Whole Poultry by Micro power

Season as desired, but salt after cooking. Browning sauce mixed with equal parts of butter will enhance the appearance.

Poultry must be unstuffed. Tie legs together with cotton string. Place on a microwave rack set in a rectangular dish. Place poultry breast-side down: turn over halfway through cooking. Cover with wax paper to prevent splattering.

If the poultry is not cooked enough, return it to the oven and cook a few more minutes at the recommended power level.

DO NOT USE A CONVENTIONAL MEAT THERMOMETER IN THE MICROWAVE OVEN.

Let stand, covered with foil, 10 to 15 minutes after cooking. Standing time allows the temperature to equalize throughout the food and finishes the cooking process.

If a large amount of juice accumulates in the bottom of the baking dish, occasionally drain it. If desired, reserve juices for making gravy.

Less-tender birds should be cooked in liquid such as soup or broth. Use $\frac{1}{4}$ cup per 500 g of poultry.

Use an oven cooking bag or a covered casserole.

Select a covered casserole deep enough so that bird does not touch the lid.

If an oven cooking bag is used, prepare according to package directions. Do not use wire twist-ties to close bag. Use only nylon tie, a piece of cotton string, or a strip cut from the open end of the bag. Make six 2 cm slits on top of bag.

Multiply the weight of the poultry by the minimum recommended minutes per 500 g. See chart below. Programme Micro Power and Time.

After cooking, check the internal temperature of the bird with a microwave or conventional meat thermometer inserted into the muscle. Check temperature in both muscles. The thermometer should not touch bone. If it does, the reading could be inaccurate. A thermometer cannot be accurately inserted into a small bird. To check desired cooking of a small bird, juices should be clear and the drumsticks should readily move up and down after standing time.

During cooking, it may be necessary to shield legs, wings and the breast bone with foil to prevent overcooking. Wooden toothpicks can be used to hold foil in place.



Cooking Poultry Pieces by Micro power

Cover with wax paper or paper towel. Use the chart below to determine recommended minimum cooking times.

Arrange pieces skin-side down and evenly spread in a shallow dish.

Turn or rearrange halfway through cooking. Shield wing tips, drumstick ends etc., if required.



Cooking Poultry by Micro power

POULTRY	POWER	TEMPERATURE AFTER COOKING	APPROX. COOKING TIME (minutes per 500 g)
Chickens (up to 2 kg)	P7	87°C	10 to 15
Chicken (pieces)	P7	87°C	8 to 10
Turkey	P7	87°C	12 to 17
Duck	P7	87°C	10 to 15

Cooking Whole Chicken by Sensor Cook (S)

- **Minimum Weight 1.4 kg / Maximum Weight 2.0 kg**
- Whole chickens should be cooked directly from the refrigerator and totally thawed.
- Tie legs together with string.
- Place onto a microwave rack set inside a dish.
- Place whole poultry breast side down.
- **Do not stuff** poultry with raw meat, bread crumbs or cooked rice, seasonings may be used.
- Marinate or baste chicken before cooking for added flavour and colour.
- Cover dish completely and securely with plastic wrap.
- Anytime during the cooking time, the oven will 'beep' and instruct you to turn over. At this time, shield the wings and drumstick ends, if needed. Remove plastic.
- Let stand 10 to 15 minutes at the completion of cooking. This makes carving the meat easier and ensures that the heat is even throughout.

To Operate: Select **Whole Chicken**, then press **Start**.

Cooking Chicken Pieces by Sensor Cook (S) / Auto Cook [A]

- Suitable for cooking chicken pieces, such as wings, thighs, drumsticks and breasts.
- Chicken pieces should be completely thawed before cooking.
- Marinate chicken pieces before cooking for added flavour and colour.
- Arrange chicken pieces skin side down with thicker, meatier portions towards the edge of dish.

Sensor Cook (S) (250 g - 1.2 kg)

- Cover dish securely with plastic wrap.
- Anytime during the cooking time, the oven will 'beep' and instruct you to turn over/rearrange. Remove the plastic wrap completely from dish. There is no need to re-cover.
- Let stand 5 to 10 minutes at the completion of cooking.

To Operate by Sensor Cook: Select **Chicken Pieces**, then press **Start**.

Auto Cook [A] (400 g - 1.0 kg)

- Leave chicken pieces uncovered if desired.
- Halfway through the cooking time, the oven will 'beep' and prompt you to turn over and re-arrange the chicken pieces.
- Let stand 5 to 10 minutes at the completion of cooking.

To Operate by Auto Cook: Press **Auto Cook** to **Chicken Pieces**. Select the serving / weight, then press **Start**.

Cooking Eggs by Micro Power

Boiled Eggs: Do not boil eggs in your microwave. Raw eggs boiled in their shells can explode and cause serious injury.

Poached Eggs: The membrane on egg yolks must be pierced before cooking, otherwise steam will build up and cause yolk to pop.

Scrambled Eggs: Slightly undercook scrambled eggs as they will finish cooking during standing.

SCRAMBLED EGGS

Serves: 2

Ingredients:

4 x 61 g	eggs
4 tablespoons	milk
	pinch of salt

Method:

In 1-litre casserole dish, beat eggs lightly with whisk. Add milk and salt. Whisk until well combined. Cover dish with plastic wrap and cook on P6 for 2 to 2½ minutes. Stir eggs and cook for further 2½ to 3 minutes. Stand, covered, for 1 minute before serving.

POACHED EGGS

Serves: 2

Ingredients:

2 x 61 g	eggs
½ cup	hot tap water
	dash of vinegar
	pinch of salt

Method:

Place one quarter of cup of water, dash of vinegar and pinch of salt into 2 ramekin dishes or small glass

bowls. Heat water on P10 for 30 - 60 seconds. Break egg into the water and with toothpick pierce the egg yolk twice and egg white several times. Cover dishes with plastic wrap and cook on P6 for 1 to 1½ minutes. Stand, covered, for 1 minute before serving.

Note: The size of the eggs will alter cooking time.

GREEN PEPPERCORN CHICKEN

Serves: 4

Recipe Prompting**Ingredients:**

500 g	sliced chicken breast fillets
2 tablespoons	green peppercorns
1 tablespoon	seeded mustard
1 teaspoon	chicken stock powder
2 tablespoons	lemon juice
½ cup	cream

Method:

Place chicken in a 3-litre casserole dish. Cook on P7 for 8 to 10 minutes stirring halfway through cooking. Mix together peppercorns, mustard, stock powder, lemon juice and cream. Pour over chicken, stir. Cook on P10 for 2 to 3 minutes.

HONEY MUSTARD DRUMSTICKS (S) A

Serves: 3 to 4

Ingredients:

1.3 kg	chicken drumsticks
2 tablespoons	worcestershire sauce
¼ cup	honey
1 tablespoon	seeded mustard
1 teaspoon	curry powder

Method:

Place drumsticks into a shallow casserole dish. Mix together the remaining ingredients and combine with the drumsticks. Marinate for at least 2 hours in the refrigerator. Cook on P7 for 18 to 20 minutes, turning halfway through cooking. Serve with boiled rice or noodles.

To cook by Sensor Cook / Auto Cook:

Prepare as above. Refer to directions on page 14.

THAI CHICKEN WINGS (S) A

Serves: 3 to 4

Ingredients:

1 kg	chicken wings
2 tablespoons	soy sauce
2 tablespoons	fish sauce
2 tablespoons	lime juice
1 teaspoon	crushed garlic
1 teaspoon	crushed ginger
1 teaspoon	crushed chilli

Method:

Place wings into a shallow dish. Combine remaining ingredients and pour over wings. Marinate for at least 2 hours in the refrigerator. Drain chicken from marinade and return to dish. Cook on P7 for 15 to 20 minutes, rearranging halfway through cooking.

To cook by Sensor Cook / Auto Cook:

Prepare as above. Refer to directions on page 14.

ZUCCHINI SLICE

Serves: 4 to 6

Ingredients:

4 rashers	bacon, diced
1	onion, diced
2 cups	grated zucchini
2 cups	grated carrot
1 cup	grated tasty cheese
1 cup	self raising flour
5	eggs, lightly beaten
125 ml	vegetable oil
1 tablespoon	fresh chopped parsley
salt and pepper	

Method:

Lightly grease a 25 cm square microwave safe dish. Place bacon and onion in a 2-litre casserole dish and cook on P10 for 2 to 3 minutes. Allow to cool slightly. Stir in zucchini, carrot, cheese and flour. In a 1-litre bowl whisk together eggs, oil and parsley. Add to bacon mixture season with salt and pepper and stir until combined. Pour into prepared dish. Cook on P6 for 18 to 20 minutes.

CHICKEN BURRITOS

Serves: 4 to 6

Ingredients:

1	clove garlic, crushed
2	large onions, chopped
1 teaspoon	chilli powder (optional)
1 (35 g)	packet taco seasoning mix
500 g	chicken tenderloins, diced
425 g	can red Kidney beans
½ cup	tomato paste
½ cup	water
1 cup	grated cheese
10	tortillas

Method:

Place garlic, onion and chilli in a 3-litre casserole dish. Cook on P10 for 2 minutes. Stir in remaining ingredients except cheese and tortillas. Cover and cook on P7 for 16 to 18 minutes, stirring twice during cooking. Serve in warmed tortillas topped with grated cheese.

CHICKEN CACCIATORE

Serves: 4

Recipe Prompting**Ingredients:**

440 g	can tomatoes
¼ cup	tomato paste
1 teaspoon	minced garlic
1	onion, diced
2 teaspoons	dried oregano
1 kg	chicken drumsticks

Method:

Place all ingredients in a 2-litre casserole dish. Stir until combined. Cover and cook on P7 for 10 to 12 minutes. Turn chicken and stir. Cook on P7 for 10 to 12 minutes.

CHICKEN ROLLS WITH HONEY MUSTARD

Serves: 4 to 6

Ingredients:

8	chicken thigh fillets
16	prunes, pitted
8	green onions, sliced
2 tablespoon	flaked almonds
4 rashers	rindless bacon, halved lengthwise

Honey Mustard Glaze

1 tablespoon	brown sugar
1 tablespoon	French mustard
1 tablespoon	honey
10 g	butter, melted
	ground black pepper

Method:

Open out each thigh fillet and trim away fat. Place 2 prunes, some green onion and a few flaked almonds on each fillet. Roll fillets up and wrap a piece of bacon around each one. Secure with toothpicks. Blend all glaze ingredients together in a small bowl. Place chicken into a 3-litre dish in a single layer and brush with glaze mixture. Cook on P7 for 16 to 20 minutes, turning halfway through cooking.

CHICKEN AND ASPARAGUS RISOTTO

Serves: 4

Ingredients:

300 g	fresh asparagus, chopped
2 tablespoon	olive oil
1 ½ cups	arborio rice
1	clove garlic, crushed
4 cups	boiling chicken stock
2 cups	coarsely chopped cooked chicken
¼ cup	grated fresh parmesan cheese
¼ cup	cream
1 tablespoon	chopped parsley
	ground black pepper
extra	coarsely grated parmesan cheese

Method:

Place asparagus into 2-litre dish and cook on P10 for 1 minute. Set aside. Place oil, rice and garlic in a large microwave safe bowl. Cook covered on P10 for 1 minute. Add 2 cups of boiling chicken stock, cook on P10 for 5 minutes. Stir twice during cooking. Add remaining chicken stock and cook on P10 for another 5 minutes. Add remaining ingredients along with asparagus and stir into risotto. Cook covered on P10 for 2 minutes. Stand for 5 minutes. Serve topped with extra parmesan and black pepper.

HINT:

- A No. 15 (1.5 kg) chicken will make 4 cups of diced cooked chicken.
- 2 half breasts will make 2 cups of diced cooked chicken.
- 1 chicken maryland will make 1 cup of diced cooked chicken.

HONEY SESAME DRUMSTICKS (S) A

Serves: 3 to 4

Recipe Prompting

Ingredients:

8 (1.3 kg)	chicken drumsticks
1 teaspoon	chopped garlic
1 teaspoon	chopped ginger
¼ cup	soy sauce
¼ cup	honey
2 tablespoons	sesame seeds

Method:

Place all ingredients in 2-litre bowl, stir until combined. Marinate for at least 2 hours or overnight. Remove chicken from marinade and place in shallow dish with the meatiest ends to the outside. Cook on P7 for 18 to 20 minutes, turning once during cooking.

To cook by Sensor Cook / Auto Cook:

Prepare as above. Refer to directions on page 14.

CHICKEN WINGS IN LEMON SAUCE (S) A

Serves: 4 to 6

Ingredients:

1 kg	chicken wings
¼ cup	soy sauce
1 teaspoon	ginger powder
2	cloves garlic, crushed
¼ cup	lemon juice

Method:

Place chicken wings in 3-litre casserole dish. Mix together remaining ingredients and pour over chicken wings. Marinate for 1 to 2 hours in the refrigerator. Cook, covered, on P7 for 15 to 20 minutes. Serve hot with rice.

To cook by Sensor Cook / Auto Cook:

Prepare as above. Refer to directions on page 14.



Chicken Wings in Lemon Sauce

COQ AU VIN (S)

Serves: 4 to 6

Ingredients:

750 g	chicken thigh fillets, diced
4 rashers	bacon, chopped
8	baby onions, peeled
2 cloves	garlic, crushed
½ cup	white wine
1½ cups	chicken stock
¼ cup	tomato paste
300 g	button mushrooms
1 tablespoon	plain flour

Method:

Place chicken, bacon, onions and garlic in a 3-litre casserole dish cook on P10 for 8 to 10 minutes. Add remaining ingredients except flour cook on P6 for 20 to 25 minutes, stirring halfway through cooking. Mix flour with two tablespoons water and stir into chicken mixture. Cook on P10 for 2 to 3 minutes. Serve with rice or crusty bread.

To cook by Sensor Cook:

Place all ingredients except flour in a 3-litre casserole dish cover with plastic wrap. Select **Casseroles**, then

Start. Finish by thickening with flour as above.

CHICKEN AND POTATO CASSEROLE

Serves: 4

Ingredients:

1	cooked BBQ chicken
500 g	potatoes, peeled and thinly sliced
1¼ cups	water
30 g	butter
1	onion, finely chopped
1	clove garlic, crushed
2 tablespoons	plain flour
1 cup	chicken stock
1 teaspoon	french mustard
½ cup	cream
¾ cup	grated tasty cheese
	paprika

Method:

Remove chicken meat from bones. Place potatoes and water in a 2-litre casserole dish. Cover and cook on P10 for 8 to 10 minutes. Drain. Combine chicken and potatoes. Set aside. Place butter in a 4-cup glass jug and cook on P7 for 40 seconds. Add onion and garlic to jug and cook on P10 for 1 to 2 minutes. Add flour and stir. Gradually add stock and blend to a smooth paste. Cook on P10 for 2 to 3 minutes. Stir every minute.

Add mustard and cream. Stir well. Pour sauce over chicken and potato mixture. Sprinkle with cheese and paprika. Cook on P7 for 4 to 6 minutes. Serve with vegetables.

CHICKEN CURRY

Serves: 4

Recipe Prompting

Ingredients:

1	onion, chopped
2 tablespoons	red curry paste
500 g	chicken fillets, sliced
2 cups	finely sliced vegetables
1 cup	coconut milk

Method:

Place onion and curry paste in a 3-litre casserole dish. Cook on P10 for 3 to 4 minutes. Add chicken and combine. Cook on P7 for 6 minutes, stirring once during cooking. Add vegetables and coconut milk. Stir well. Cover and cook on P10 for 4 to 6 minutes.

Serve with Jasmine rice.

SPICY CHICKEN CURRY

Serves: 4 to 6

Ingredients:

1	onion, finely chopped
1	clove garlic, crushed
1 teaspoon	finely grated root ginger
2 teaspoons	ground coriander
½ teaspoon	ground turmeric
1 teaspoon	ground cumin
1 teaspoon	chilli powder
3 tablespoons	vinegar
1 kg	chicken breast fillets, cut into strips
1 cup	chicken stock
¼ cup	coconut cream

Method:

Place onion, garlic and ginger in a 3-litre dish and cook on P10 for 2 to 3 minutes. Add spices and vinegar to onion mixture and cook on P10 for 1 to 2 minutes. Add chicken and stock to onion mixture and cook on P6 for 10 to 15 minutes, stirring 2 to 3 times. Before serving, stir through coconut cream. Heat for 1 to 2 minutes on P6. Serve with rice, pappadums and sambals.



Spicy Chicken Curry

Cooking Tender Cuts of Meat using Micro power

For best results, select roasts that are uniform in shape.

Place meat on a microwave rack in a suitable dish.

Beef rib roast should be placed cut-side down. Other

bone-in roasts should be placed fat-side down.

Boneless roasts should be placed fat-side up.

Halfway through cooking, turn roasts. Half hams

should be shielded by wrapping an 8 cm wide strip of

foil around the large end of the ham. Secure to the

body of the ham with wooden toothpicks. Fold 3 cm

over cut surface. For shank ham halves, shield

shank bone by cupping it with foil. One third of the

way through cooking, remove ham from oven and

cut off skin. Turn fat side up and reshield edges. If

desired, glaze last 10 to 20 minutes of cooking.

Loosely cover baking dish with wax paper or paper

towel to prevent splatter. If a large amount of juice

accumulates in the bottom of the dish, drain

occasionally. If desired, reserve for making gravy.

Multiply the weight of the roast by the minimum

recommended times per 500g. Programme Micro

Power and Time.

Meats can be shielded at the beginning of cooking or

halfway through cooking. If you wish to shield at the

beginning of cooking, remove foil halfway through

the cooking time. Beef and pork rib roasts should be

shielded around the bones. Foil should extend about

5 cm down from bones. The shank and thin ends of

boneless roasts should also be shielded. Make sure

foil does not touch the sides of the oven, as arcing

may occur. Canned hams should be shielded on the

top cut-edge with a 3 cm strip of foil. Wrap strip of

foil around ham and secure to body of ham with

wooden toothpicks. Fold 2 cm over cut surface. After

heating, check temperature using a meat

thermometer. The thermometer should not touch

bone or fat. If it does, the reading could be

inaccurate. Lower temperatures are found in the

centre of the roast and in the muscle close to a large

bone, such as a pork loin centre rib roast. If the

temperatures are low, return meat to the oven and

cook a few more minutes at the recommended

power level. **DO NOT USE A CONVENTIONAL**

MEAT THERMOMETER IN THE MICROWAVE

OVEN. Let stand, covered with foil, 10 to 15 minutes.

During standing time the internal temperature

equalises and the temperature rises 5°C to 10°C.

Cooking Less-Tender Cuts of Meat using Micro power

Less-tender cuts of meat such as pot roasts should

be cooked in liquid. Use ½ to 2 cups of soup, broth,

etc. per 500g of meat. Use an oven cooking bag or

covered casserole when cooking less-tender cuts of

meat. Select a covered casserole deep enough so

that the meat does not touch the lid. If an oven

cooking bag is used, prepare the bag according to

package directions. Do not use wire or metal

twist-ties. Use the nylon tie provided, otherwise, use

a piece of cotton string or a strip cut from the open

end of the bag. Make six 2 cm slits in top of bag to

allow steam to escape. Multiply the weight of the

roast by the minimum recommended minutes per

500g as suggested in the chart below. Programme

Micro Power and Time. Turn meat over halfway

through cooking. Meat should be tender when

cooked.

Cooking meat by Micro power

MEAT	POWER	APPROX. COOKING TIME (minutes per 500 g)
Beef		
Roasts		
Rare	P6	10 to 12
Medium	P6	12 to 14
Well	P6	14 to 16
Pot Roast	P2	25 to 30
Pork		
Leg of Pork	P7	11 to 13
Loin of Pork	P7	11 to 13
Ham Canned (fully cooked)	P7	4 to 5
Lamb		
Medium	P6	8 to 10
Well	P6	12 to 14

Cooking Curries by Sensor Cook (S) / Auto Cook **A** (250 g - 750 g)

(Weight of only meat)

- Refer to chart below for quantities to use.
- Cut meat and vegetables into even size pieces.
- Place curry paste, meat, onion and hard vegetables into a suitable size casserole dish, do not use plastic dishes. Cover with plastic wrap. Press curries then Start.
- When oven beeps add remaining ingredients including liquid and continue to cook by pressing **Start**.
- At the end of cooking time, allow to stand for 5-10 minutes.

To Operate for Sensor Cook:

Select **Curries**, then press **Start**.

To Operate for Auto Cook to Curries:

Select the serving / weight, then press **Start**.

THAI BEEF CURRY

Serves: 4 to 6

Ingredients:

1	onion, thinly sliced
2 tablespoons	Thai green curry paste
500 g	thinly sliced lean beef
1/2	red capsicum, thinly sliced
1	carrot, thinly sliced
1	zucchini, sliced
200 g	broccoli, broken into flowerets
1 cup	coconut milk
1 tablespoon	soy sauce
1 tablespoon	lemon juice
2 tablespoons	shredded fresh basil
1/2 cup	roasted unsalted peanuts

Method:

Place the onion and curry paste into a 4-litre dish. Cook on P10 for 2 to 3 minutes. Add the beef and cook on P10 for 4 to 6 minutes, stirring halfway through cooking. Add the vegetables and coconut milk and cook on P10 for 6 to 8 minutes. Mix in the soy sauce, lemon juice and basil and serve sprinkled with peanuts.

LAMB KORMA (S) **A**

Serves: 4

Ingredients:

1	onion, diced
500 g	lamb, cubed
1/3 cup	korma curry paste
2 cups	carrots sliced
250 ml	tomato puree
250 ml	beef stock
2 tablespoons	natural yoghurt

Method:

Place onion, lamb, curry paste and carrot in a 3-litre casserole dish. Cook on P10 for 6 minutes. Add tomato puree and beef stock and stir, cook on P6 for 40 minutes, stirring once during cooking. Stir in yoghurt and serve with basmati rice.

To cook by Sensor Cook / Auto Cook:

Prepare as above. Refer to directions on page 19.

MUSSAMAN BEEF CURRY (S) **A**

Serves: 4

Ingredients:

500 g	round steak diced
1/3 cup	mussaman curry paste
400 g	potato diced
250 ml	coconut milk
250 ml	beef stock
1 tablespoon	brown sugar

Method:

Place steak, curry paste and potato in a 3-litre casserole dish cook on P10 for 6 minutes. Add coconut milk, stock and brown sugar, stir, cook on P5 for 40 minutes. Stir once during cooking serve with jasmine rice.

To cook by Sensor Cook / Auto Cook:

Prepare as above. Refer to directions on page 19.

HINT:

TO COOK PAPPADUMS:

Place on paper towel lined microwave safe plate. Cook on P10 for 15 to 20 seconds for each pappadum, turning halfway through cooking. Allow to stand 1 minute before serving.

General Guide to Curries For Sensor Cook / Auto Cook

Serves	Weight of meat	Amount of liquid (coconut milk, stock)	Weight of hard vegetables
2	250 g	375 ml	200 g
4	500 g	500 ml	400 g
6	750 g	750 ml	600 g

Cooking Casseroles by Sensor Cook (500g-2.0kg) (Weight includes all ingredients) (S)

- Suitable for cooking casseroles with less tender cuts of meat combined with liquid and vegetables.
- Cut meat and vegetables into even size pieces.
- Place in a suitable size dish. Dish should be approximately $\frac{3}{4}$ full.
- Do not use plastic dishes as incorrect cooking time may result.
- Add $1\frac{1}{2}$ to 2 cups of soup, broth or stock per 500 g of meat.
- Cover securely with plastic wrap or a well fitting lid.
- During the cooking time, the oven will 'beep' and instruct you to 'STIR'.
- At the end of cooking time, allow the casserole to stand for 5 to 10 minutes.

To Operate by Sensor Cook:
Select **Casseroles**, then **Start**.

GOULASH (S)

Serves: 4

Ingredients:

1	onion, chopped
1	clove garlic, crushed
1 tablespoon	butter
2 tablespoons	tomato paste
$\frac{1}{2}$ teaspoon	paprika
500 g	lamb, diced
1	small capsicum, diced
1 cup	beef stock
2 tablespoons	flour
2 tablespoons	water
2 tablespoons	sour cream

Method:

Place onion, garlic and butter in 3-litre casserole dish. Cook on P10 for 1 to 2 minutes. Add tomato paste and paprika. Cook on P10 for a further 2 minutes. Add lamb, capsicum and stock. Cover and cook on P6 for 25 to 30 minutes, stirring halfway through cooking. Mix flour with 2 tablespoons of water and stir into goulash mixture. Cook on P10 for 1 to 2 minutes.

Stir in sour cream and serve with pasta and rice.

To Cook by Sensor Cook:

Prepare as above. Cover with plastic wrap.
Select **Casseroles**, then **Start**.

HINT:

It is better to cook meat for a lesser time in a recipe and add extra time if needed. This will prevent over cooking.

PEPPER POT BEEF (S)

Serves: 4

Ingredients:

1 teaspoon	minced garlic
1	red capsicum, sliced
400 g	can tomatoes
425 g	can tomato puree
750 g	cubed beef
$\frac{1}{4}$ cup	tomato paste
1 tablespoon	worcestershire sauce
1 teaspoon	cracked black pepper

Method:

Combine all ingredients in 3-litre casserole dish. Cook on P7 for 15 minutes. Stir, cook on P6 for 25 minutes. Serve with boiled or steamed rice.

To Cook by Sensor Cook:

Prepare as above, cover with plastic wrap.
Select **Casseroles**, then **Start**.

FRENCH ONION BEEF CASSEROLE (S)

Serves: 4

Recipe Prompting

Ingredients:

1	onion, chopped
1 teaspoon	minced garlic
200 g	diced potatoes
500 g	beef, diced
2	carrots, diced
$\frac{1}{3}$ cup	tomato paste
1 cup	beef stock
100 g	whole button mushroom
$\frac{1}{4}$ cup	frozen peas

Method:

Place onion and garlic in 3-litre casserole dish. Cook on P10 for 1 to 2 minutes. Add remaining ingredients, except mushrooms and peas. Stir until combined. Cover and cook on P10 for 8 minutes. Stir and cook on P4 for 28 to 30 minutes. Add mushrooms and frozen peas. Stir cook on P4 for 14 to 15 minutes.

To Cook by Sensor Cook:

Prepare as above, cover with plastic wrap.
Press **Casserole**, then **Start**.

BEEF BOURGUIGNONNE (S)

Serves: 4 to 6

Ingredients:

750 g	diced chuck steak
4 rashers	bacon
6	pickling, onions
2 teaspoons	minced garlic
$\frac{1}{4}$ cup	red wine
425 ml	tomato puree
$\frac{1}{2}$ cup	beef stock
1 teaspoon	minced chilli
1 teaspoon	tarragon
250 g	button mushrooms, halved

Method:

Place all ingredients except mushrooms in a 3-litre casserole dish, stir until combined. Cover and cook on P7 for 10 to 15 minutes. Stir and cook on P6 for 25 to 30 minutes. Stir and add mushrooms halfway through cooking.

To Cook by Sensor Cook:

Prepare as above, cover with plastic wrap.
Select **Casseroles**, then **Start**.

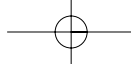

LASAGNE

Serves: 4 to 6

Ingredients:

Meat Sauce:

500 g	minced beef
2	small onions, chopped
1	clove garlic, chopped
1 (425 g)	can tomato purée
1 cup	beef stock
1/4 cup	chopped basil
1 tablespoon	cracked black pepper

Cheese Sauce:

80 g	butter
1/4 cup	flour
500 ml	milk
1/2 cup	grated cheese
1/2 cup	Parmesan cheese
12	lasagne sheets, cooked
1/2 cup	extra grated cheese

Method:

Meat Sauce:

Combine all meat sauce ingredients in 4-litre casserole dish. Cook on P7 for 30 to 35 minutes, stirring several times during cooking. Set aside.

Cheese Sauce:

Melt butter in 2-litre jug on P10 for 30 to 40 seconds. Add flour and mix well. Gradually stir in milk. Cook on P10 for 3 to 4 minutes. Stirring halfway through cooking. Add grated cheese and Parmesan cheese. Cook on P10 for 50 to 60 seconds. Spoon quarter of the meat sauce into the base of 25 x 25 cm deep casserole dish. Top with three lasagne sheets. Spoon another quarter of meat sauce over the lasagne sheets and spread with cheese sauce. Continue with remaining ingredients. Top with meat and cheese sauce. Sprinkle with extra cheese and cook on P7 for 20 to 25 minutes.

BARBECUED MARINATED SPARE RIBS

Serves: 4

Ingredients:

1 kg	pork spare ribs
3/4 cup	fruit chutney
3/4 cup	tomato sauce
1 tablespoon	soy sauce
1 tablespoon	worcestershire sauce

Method:

Place all ingredients in 3-litre casserole dish and marinate for several hours or overnight. Cook ribs covered on P7 for 20 to 25 minutes, turning once during cooking.

GINGERED PORK STIR FRY

Serves: 4

Ingredients:

500 g	sliced lean pork
1/4 cup	teriyaki sauce
1 tablespoon	honey
2 teaspoons	minced ginger
2 teaspoons	cornflour
1	onion, sliced
300 g	sugar snap peas, trimmed
1	zucchini, sliced
1/2	red capsicum, sliced
2	green onions, sliced
1/2 cup	bean sprouts
1 tablespoon	toasted sesame seeds

Method:

Place pork, teriyaki sauce, honey, ginger and cornflour in a 2-litre dish. Cover and marinate in the refrigerator for 2 hours. Place onion in a 3 litre dish.



Corned Beef

Cook on P10 for 1 to 2 minutes. Add marinated pork and sauces and cook on P7 for 3 to 4 minutes. Add peas, zucchini, capsicum, green onions and bean sprouts. Cook on P10 for 3 to 4 minutes. Sprinkle with sesame seeds and serve with noodles.

CORNE BEEF

Serves: 4

Ingredients:

1.5 to 1.7 kg	corned silverside
1 tablespoon	brown sugar
1 tablespoon	white vinegar
1	onion, cut in half
4	cloves
6	peppercorns
1	bay leaf
3 cups	water

Method:

Rinse corned silverside under cold running water to remove excess salt. Place corned silverside in 4-litre casserole dish. Add remaining ingredients. Cover and cook on P10 for 10 minutes. Turn meat, cover and cook on P3 for 1 1/4 to 1 1/2 hours. Stand corned silverside in cooking liquid for 10 minutes before carving.

Note: Depending on the size and shape of the silverside, it may require a further 10 to 15 minutes on P3.

LAMB PILAU

Serves: 4

Ingredients:

1 tablespoon	oil
1	large onion, sliced
600 g	lean diced lamb
400 g	can tomato pieces
2 tablespoons	garam masala
1 teaspoon	dried thyme
1 cup	long grain rice
600ml	hot chicken stock
150g	natural yoghurt
	freshly ground black pepper

Method:

Place the onion and oil in a 3 litre dish. Cover and cook on P10 for 2 to 3 minutes. Add lamb, tomato pieces, garam masala, and thyme. Cover and cook on P7 for 10 minutes. Stir. Cook on P7 for a further 10 minutes. Add the rice and chicken stock and cook covered on P5 for a further 30 minutes or until the rice is tender. Stir in yoghurt, season with pepper and serve.

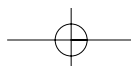
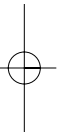

SPAGHETTI MEAT SAUCE

Serves: 4 to 6

Recipe Prompting

Ingredients:

500 g	minced beef
1	onion, chopped
1 teaspoon	minced garlic
1 (425 g)	can tomatoes
1 cup	tomato puree
2	beef stock cubes
1 teaspoon	dried mixed herbs
	pepper

Method:

Combine all ingredients in a 3-litre casserole dish. Cook on P10 for 7 minutes, stir. Cook on P7 for 14 to 16 minutes. Stir halfway through cooking. Serve with spaghetti.

BEEF STROGANOFF

Serves: 4

Recipe Prompting

Ingredients:

1	onion, sliced
1 teaspoon	minced garlic
1 teaspoon	paprika
750 g	rump steak sliced thinly
2 tablespoons	tomato sauce
2 tablespoons	worcestershire sauce
1	beef stock cube
200 g	sliced mushrooms
1/3 cup	sour cream

Method:

Place all ingredients (except sour cream and mushrooms) in a 3-litre casserole dish. Stir until combined. Cook on P7 for 7 to 9 minutes, stirring once during cooking. Add mushrooms. Stir and cook on P7 for 3 to 4 minutes. Stir through sour cream.

CHINESE BEEF AND VEGETABLES

Serves: 4 to 6

Recipe Prompting

Ingredients:

500 g	rump steak sliced
1 teaspoon	chopped ginger
1 teaspoon	chopped garlic
1 tablespoon	soy sauce
1/4 cup	Hoisin sauce
1/4 cup	sweet chilli sauce
3 cups	sliced vegetables

Method:

Place steak, ginger and garlic in a 3-litre casserole dish. Cook on P10 for 1 minute. In 1-cup jug, combine soy sauce, Hoisin sauce and sweet chilli. Add to meat mixture. Cook on P10 for 3 to 4 minutes. Add the vegetables, cover and cook on P10 for 3 to 5 minutes, stirring halfway through cooking. Let stand for 5 minutes before serving.



Seasoned Roast Lamb

SEASONED ROAST LAMB

Serves: 4 to 6

Recipe Prompting

Ingredients:

1.4 kg	leg of lamb
1 tablespoon	seeded mustard
1 tablespoon	rosemary

Method:

Place lamb fat side down on rack set in a 3-litre dish. Brush with mustard and rosemary. Cook on P6 for 30 to 35 minutes, turn halfway through cooking. Stand, covered, for 15 minutes before slicing.

CHILLI BEEF

Serves: 4

Recipe Prompting

Ingredients:

500 g	topside beef mince
1 teaspoon	minced garlic
1 (35 g)	packet chilli seasoning mix
1 (400 g)	can tomato purée
1 (440 g)	can kidney beans, drained

Method:

Place all ingredients in a 3-litre dish. Mix well. Cook on P10 for 17 to 19 minutes. Stir halfway through cooking. Serve in taco shells with chopped tomatoes and shredded lettuce or with a salad and crusty bread.

Cooking Fresh Vegetables by Micro power

Place vegetables in a casserole dish. Add 2 to 3 tablespoons of water per 500 g of vegetables. Add salt to water or add after cooking. Do not place salt directly on vegetables. Cover dish with glass lid or plastic wrap.

Cook on P10 according to time recommended in the chart. Halfway through cooking, stir, turn vegetables

over or rearrange.

Vegetables that are to be cooked whole and unpeeled, need to be pierced to allow steam to escape. Place vegetables on a paper towel lined dinner plate. Allow to stand, covered, according to the time indicated in the charts.

Cooking Fresh Vegetables by Micro power

Vegetables should be covered and cooked on P10 power for best results. Weights given are trimmed weights.

VEGETABLE	QUANTITY	COOKING PROCEDURE	APPROX. COOKING TIME (in minutes) on P10
Asparagus	250 g	Covered dish with $\frac{1}{4}$ cup water.	1 to 3
Beans (finely sliced)	250 g	Covered dish with $\frac{1}{4}$ cup water.	3 to 5
Beetroot	4 whole (1 kg)	Covered with 1 cup water in 4-litre dish. Stand after cooking - 5 mins.	14 to 18
Broccoli	250 g	Covered dish with $\frac{1}{4}$ cup water.	4 to 6
Brussels Sprouts	250 g	Covered dish with $\frac{1}{4}$ cup water.	4 to 6
Cabbage	500 g	Shredded, with $\frac{1}{4}$ cup water in covered dish.	5 to 7
Carrots	4 (sliced finely) 250 g	With $\frac{1}{4}$ cup water in covered dish.	5 to 6
Cauliflower	500 g	With $\frac{1}{4}$ cup water in covered dish.	6 to 8
Celery	6 stalks (400 g) cut in 1 cm pieces	With $\frac{1}{4}$ cup water in covered dish.	4 to 6
Corn	2 cobs (500 g) 4 cobs (1 kg)	Brush with melted butter and cook in covered dish.	4 to 6 10 to 12
Eggplant	1 (500 g)	Dice with $\frac{1}{4}$ cup water in covered dish.	4 to 6
Mushrooms	250 g (sliced)	Cook with 2 tablespoons butter in covered dish.	2 to 4
Onions	3 (200 g)	Cut in quarters with $\frac{1}{4}$ cup water in covered dish.	5 to 7
Peas	250 g	Shell peas and place with $\frac{1}{4}$ cup water in covered dish.	3 to 5
Potatoes-Mashed -Jacket	500 g 3 Med	Peeled and quartered with $\frac{1}{4}$ cup water. Covered. Cook uncovered on paper towel lined plate.	8 to 10 6 to 8
Pumpkin	500 g	Peeled and cut into uniform pieces with $\frac{1}{4}$ cup water in covered dish.	7 to 9
Spinach / Silver beet	250 g	Remove stem, cut leaves into small pieces. Cook with $\frac{1}{4}$ cup water in covered dish.	4 to 6
Sweet Potato	500 g	In serving size pieces with 2 tablespoons water in covered dish.	7 to 9
Turnips	500 g	Peeled and sliced finely with $\frac{1}{4}$ cup water in covered dish.	6 to 8
Tomatoes	2 (300 g)	Sliced and cooked covered.	2 to 4
Zucchini	500 g	Cut in 2 cm pieces in covered dish.	5 to 7

Cooking Vegetables and Root Vegetables by Sensor Cook and Auto Cook (S) A**Vegetables****(120 g - 500 g) by Sensor Cook****(120 g - 370 g) by Auto Cook**

- Suitable for cooking all types of leaf, green and soft varieties of vegetables, including broccoli, squash cauliflower, cabbage, asparagus, beans, celery, zucchini, spinach, capsicum or a mixture of these.
- All vegetables should be trimmed or prepared and cut into evenly sized pieces.
- Add 1 tablespoon to $\frac{1}{4}$ cup of water to vegetables if dehydrated or a softer cooked texture is desired.
- Place in a suitable size dish.
- Butter, herbs, etc., may be added before heating, but do not salt vegetables until serving.
- Cover dishes securely with plastic wrap or a fitted lid.
- At the completion of heating, stir larger quantities of vegetables. Let stand, covered, for 2 to 3 minutes.

To Operate by Sensor Cook:Select **Vegetables**, then press **Start**.**To Operate by Auto Cook:**Press **Auto Cook to Vegetables**. Select the serving / weight, then press **Start**.**COOKING FROZEN VEGETABLES BY MICRO****POWER**

Remove vegetables from package and place in an appropriate sized container. Vegetables frozen in a pouch should be placed on a dish and the top pierced. Cook on P10 according to directions given in chart. Vegetables should be cooked covered with a

Cooking Frozen Vegetables by Micro Power

VEGETABLE	QUANTITY	COOKING PROCEDURE	APPROX. COOKING TIME (in minutes) on P10
Beans	250 g	Cook in covered 2-litre dish.	4 to 6
Broad Beans	250 g	Cook in covered 2-litre dish.	5 to 7
Broccoli (spears)	350 g	Cook in covered 2-litre dish.	5 to 7
Brussels Sprouts	250 g	Cook in covered 2-litre dish.	5 to 7
Carrots (baby)	250 g	Cook in covered 2-litre dish.	6 to 8
Cauliflower	500 g	Cook in covered 2-litre dish.	5 to 7
Corn ($\frac{1}{2}$ cob)	125 g	Cook in covered 2-litre dish.	3 to 4
Corn (cobs)	250 g	Cook in covered 2-litre dish.	5 to 7
Mixed Vegetables	250 g	Cook in covered 2-litre dish.	5 to 7
Peas	250 g	Cook in covered 2-litre dish.	4 to 6
Spinach	250 g	Cook in covered 2-litre dish.	4 to 6

COOKING FROZEN VEGETABLES BY SENSOR COOK / AUTO COOK**(125 g - 1.0 kg) by Sensor Cook****(120 g - 750 g) by Auto Cook**

- Suitable for all types of frozen vegetables.
- Place in a suitable size dish.
- Best results are achieved if large quantities are placed in a single layer.
- Add 1 tablespoon to $\frac{1}{4}$ cup water to vegetables, if desired.

POTATOES**(250 g - 1.0 kg) by Sensor Cook****(250 g - 900 g) by Auto Cook**

- Suitable for cooking root vegetables such as potatoes, sweet potatoes, pumpkin, onions, swede, carrots, turnip and beetroot.
- All vegetables should be trimmed or prepared and cut into even sized pieces.
- Add 1 tablespoon to $\frac{1}{4}$ cup of water to vegetables if dehydrated or a softer cooked texture is desired.
- Place into an appropriate size dish and cover securely with plastic wrap or a fitted lid.
- If desired, butter, herbs etc. may be added but do not add salt until after cooking.
- Anytime during the cooking time, the oven will 'beep' and prompt you to stir and rearrange the vegetables.
- At the completion of cooking, stir larger quantities of vegetables. Let stand, covered, for 2 to 3 minutes.

To Operate by Sensor Cook:Select **Potatoes**, then press **Start**.**To Operate by Auto Cook:**Press **Auto Cook to Potatoes**. Select the serving / weight, then press **Start**.

lid or plastic wrap.

Halfway through cooking, stir, turn vegetables over or rearrange. Stir after cooking. Allow to stand for 2 to 3 minutes before serving.

- Butter, herbs etc. may be added before heating, but do not add salt until serving.
- Cover dishes securely with plastic wrap or a fitted lid.
- During the cooking time, the oven will 'beep' and prompt you to stir and rearrange vegetables.
- At the end of the cooking time, stir vegetables and let stand, covered, for 2 to 3 minutes.

To Operate by Sensor Cook:Select **Frozen Vegetables**, then press **Start**.**To Operate by Auto Cook:**Press **Auto Cook to Frozen Vegetables**. Select the serving / weight, then press **Start**.

COOKING DRIED BEANS OR PEAS BY MICRO POWER

Place hot tap water in 4-litre dish. Bring hot water to the boil on P10 for 10 to 12 minutes. Add beans and 2 tablespoons oil to water. Cook according to directions in chart. Stir. Allow to stand, covered, for 15 to 20 minutes.

Note: Beans such as red kidney beans and lima beans should be soaked overnight before cooking. 250 g of dried beans equals about 3 cups cooked beans. Use in place of canned beans.

Cooking Dried Beans and Peas by Micro power

ITEM	CONTAINER	TO COOK BEANS on P3 (in minutes) COVERED
Lentils (250 g)	4-litre dish	15 to 20
Soup Mix (250 g)	4-litre dish	20 to 25
Split Peas or Lentils (250 g)	4 litre dish	25 to 30
Beans (250 g) Soaked overnight	4-litre dish	25 to 30

Cooking Legumes by Sensor Cook (S) / Auto Cook [A]

- Suitable for cooking chickpeas, split peas, dried beans and peas and brown rice.
- Cover legumes with cold water and soak overnight, drain.
- Place legumes and boiling water into an appropriate sized dish. (See table for quantities)

Amount of Legumes	Amount of Boiling Water	Dish Size
1 cup	3 cups	2 litre
2 cups	4 cups	3 litre
3 cups	6 cups	4 litre
4 cup	8 cups	4 litre

- During cooking the oven will beep and prompt you to stir. Remove covering.
- At the end of cooking time, allow legumes to stand for 5 minutes if required.

RED COCONUT DHAL (S) [A]

Serves: 4 to 6

Ingredients:

1 cup	red lentils
1 teaspoon	turmeric
400 ml	can coconut milk
250 ml	water
1 teaspoon	crushed red chilli
1 teaspoon	crushed garlic
	lemon juice to taste

Method:

Place all ingredients in a 2 litre casserole dish. Stir and cook on P7 for 18 to 20 minutes, stirring twice during cooking.

To cook by Sensor Cook / Auto Cook:

Prepare as above; cover with plastic wrap. Refer to Legumes directions on this page.

Chickpea Salad with Coriander Dressing (S) [A]

Serves: 4 to 6

Ingredients:

1 cup	dried chickpeas, water for soaking
3 cups	boiling water
1	red capsicum, diced
1	lebanese cucumber, diced
250 g	cherry tomatoes, quartered
1	spanish onion, diced

Coriander Dressing:

½ cup	lemon juice
2 teaspoons	sugar
½ cup	chopped fresh coriander
1 teaspoon	chopped red chilli

Method:

Cover chickpeas with water and soak overnight. Drain.

Place chickpeas and boiling water into a 3-litre dish and cook on P7 for 25 to 30 minutes.

To cook by Sensor Cook / Auto Cook:

Prepare as above, cover with plastic wrap. Refer to Legumes directions on this page.

Drain and allow to cool.

Combine remaining salad ingredients in a large bowl and mix well.

Dressing:

Combine all ingredients in a screw top jar, shake well. Pour over salad and toss well.

Lentil Hot Pot (S)

Serves: 4 to 6

Ingredients:

900 g	New potatoes
2	onions, diced
2	carrots, diced
2	stalks celery, sliced
3	cloves garlic, crushed
1 teaspoon	curry powder
415 g	can diced tomatoes
1 cup	vegetable stock
2 tablespoon	tomato paste
¾ cup	red lentils, washed
½ cup	grated cheese
	paprika
1 tablespoon	chopped parsley

Method:

Wash potatoes and place onto a paper towel lined plate. Cook on **Potatoes** or P7 for 10 to 12 minutes. Set aside. Place onion, carrot, celery and garlic into a 3 litre dish. Cook on P7 for 8 minutes. Add curry powder and cook on P7 for a further 1 minute. Add tomatoes, stock, tomato paste and lentils. Cook on P7 for 20 to 24 minutes. Slice potatoes thickly and layer over the top of lentil mixture. Sprinkle with grated cheese, paprika and parsley. Cook on P10 for 4 to 6 minutes.

To cook by Sensor Cook / Auto Cook:

Prepare potatoes as above. Cover with plastic wrap. Refer to Potatoes directions on page 24.

HUMMUS (S) A**Ingredients:**

1 cup	chick peas, water for soaking
3 cups	boiling water
2 tablespoons	lemon juice
2 teaspoon	turmeric
1/4 cup	tahini (sesame paste)
1 tablespoon	minced garlic
2 tablespoons	olive oil

Method:

Place chick peas and water into a 4-litre casserole dish and soak overnight. Drain.
Place chickpeas and boiling water into a 3-litre casserole dish and cook on P7 for 25 to 30 minutes. Drain. Process with remaining ingredients.

To cook by Sensor Cook / Auto Cook:

Prepare as above. Cover with plastic wrap. Refer to Legumes directions on page 25.

CHEESY MASHED POTATOES (S) A

Serves: 4

Recipe Prompting

Ingredients:

500 g	potatoes, peeled and diced
1/4 cup	water
1/3 cup	milk
1/4 cup	grated cheese

Method:

Place potatoes and water in a 2-litre casserole dish. Cover and cook on P10 for 10 minutes.

To cook by Sensor Cook / Auto Cook:

Prepare as above. Cover with plastic wrap. Refer to Potatoes directions on page 24.
Drain. Mash potatoes with potato masher. Add milk and grated cheese. Mix well. Cook on P10 for 1 minute. Stir well before serving.

TOMATO VEGETABLE CASSEROLE

Serves: 4 to 6

Recipe Prompting

Ingredients:

200 g	mushrooms, sliced
1	eggplant, chopped
200 g	zucchini, sliced
1	capsicum, sliced
1	onion, sliced
400 g	can tomatoes
1/2 cup	tomato paste
1 tablespoon	chopped basil
1 teaspoon	minced garlic

Method:

Place mushrooms, eggplant, zucchini, capsicum and onion in a 3-litre casserole dish. Cover. Cook on P10 for 6 minutes. Add tomatoes, tomato purée, herbs and garlic. Re-cover and cook on P10 for 6 to 8 minutes.

POTATO BAKE

Serves: 4 to 6

Recipe Prompting

Ingredients:

750 g	peeled and sliced potatoes
250 ml	cream
1/4 cup	milk
3	green onions, sliced
2	bacon rashers, chopped
1/2 cup	grated cheese

Method:

Combine potatoes, cream and milk in a 2-litre casserole dish. Cook on P10 for 15 to 18 minutes. Top with green onions, bacon and cheese. Cook on P10 for 5 minutes.

HERBED VEGETABLES

Serves: 4 to 6

Recipe Prompting

Ingredients:

200 g	sliced snow peas
200 g	sliced carrots
200 g	sliced zucchini
2 tablespoons	chopped fresh parsley

Method:

Place snow peas, carrots and zucchini in a 2-litre casserole dish. Cover. Cook on P10 for 5 to 7 minutes, stirring once during cooking. Sprinkle with parsley. Serve.

THAI VEGETABLE CURRY

Serves: 4

Recipe Prompting

Ingredients:

1	onion, sliced
2 tablespoons	green curry paste
3 cups	sliced vegetables
440 g	can chick peas, drained
1 cup	coconut milk
1 tablespoon	lemon juice
1 tablespoon	soy sauce
1/2 cup	chopped nuts

Method:

Place onion and curry paste in a 3-litre casserole dish. Cook on P10 for 2 minutes. Add vegetables, chick peas, coconut milk, lemon juice and soy sauce. Cook on P10 for 8 to 10 minutes. Sprinkle with chopped nuts. Serve with jasmine rice.

HINT:

It is better to slightly undercook vegetables as they will soften on standing. Allow to stand, covered, with plastic wrap or a lid.



Ardennis Style Potatoes

CABBAGE HAM AND ONION (S) A

Serves: 6

Ingredients:

500 g	cabbage, shredded
2 tablespoons	water
1	onion, finely chopped
1 tablespoon	butter
125 g	ham, finely chopped
	salt and pepper

Method:

Place cabbage and water in a 3-litre casserole dish. Cover and cook on P10 for 8 to 10 minutes.

To cook by Sensor Cook:

Prepare as above. Cover with plastic wrap.

Select Vegetables.

Drain and set aside. Place onion and butter in a 1-litre casserole dish and cook on P10 for 2 to 3 minutes. Add onion mixture and ham to cabbage and mix well. Return to oven and cook on P10 for 2 to 3 minutes. Season with salt and pepper. Serve.

CREAMED SPINACH (S) A

Serves: 4

Ingredients:

1	bunch spinach, roughly chopped
4	green onions, finely chopped
1	clove garlic, crushed
2 tablespoons	sour cream
	salt and pepper

Method:

Cook washed spinach leaves, shallots and garlic in a covered 3-litre casserole dish on P10 for 5 to 7 minutes.

To cook by Sensor Cook / Auto Cook:

Prepare as above. Cover with plastic wrap. Refer to Vegetables on page 24.

Drain well by squeezing between two dinner plates. Stir through sour cream. Season to taste. Cook on P10 for 1 to 2 minutes. Serve.

ARDENNIS STYLE POTATOES (S) A

Serves: 4

Ingredients:

4	medium sized potatoes
100 g	ham, finely diced
3 tablespoons	snipped chives
50 g	butter
½ cup	grated Cheddar cheese
	ground black pepper

Method:

Scrub potatoes, wash and pat dry with paper towel. Prick skins and place in a 2-litre casserole dish. Cook on P10 for 6 to 8 minutes.

To cook by Sensor Cook / Auto Cook:

Prepare as above. Cover with plastic wrap.

Refer to Potatoes on page 24.

Allow to cool slightly. Cut tops off potatoes and scoop out pulp from centre, leaving 1 to 2 cm in shell. Mash pulp and combine with remaining ingredients. Spoon filling back into potato shells. Place potatoes in 2-litre casserole dish. Cook on P10 for 2 to 3 minutes.

CAULIFLOWER AU GRATIN (S)

Serves: 4

Ingredients:

500 g	cauliflower, trimmed and cut into pieces
2 tablespoons	water
2 tablespoons	butter
1	small onion, finely chopped
2 tablespoons	flour
1 cup	milk
½ cup	grated tasty cheese

Method:

Place cauliflower and water in a shallow casserole dish. Cover and cook on P10 for 6 to 8 minutes.

To cook by Sensor Cook:

Prepare as above. Cover with plastic wrap.

Refer to Vegetables on page 24.

Stand, covered, while making sauce. Place butter and onion in 4-cup glass jug. Cook on P10 for 1 to 2 minutes. Stir in flour and cook on P10 for 1 minute. Add milk gradually. Stir well. Cook on P10 for 2 to 3 minutes, stirring halfway through cooking. Drain cauliflower and pour over sauce. Sprinkle with cheese. Cook on P7 for 1 to 2 minutes.

Note: Depending on size and arrangement of cauliflower pieces, timing will vary.

HINT:

TO SKIN TOMATOES: Cut a cross into the tomato skin. Place 1 cup of hot tap water in a 2 cup jug or bowl and heat on P10 for 1½ minutes or until boiling. Add 1 tomato and heat for a further 20 to 30 seconds. Remove and repeat procedure with remaining tomatoes. The skin will loosen and can be easily removed.

CORN ON THE COB (S)

Serves: 4

Ingredients:

4 corn cobs
2 tablespoons butter
salt and pepper

Method:

Place corn cobs in 3-litre casserole dish and dot with butter. Cook, covered, on P10 for 10 to 12 minutes. Stand, covered, for 5 minutes. Season with salt and pepper.

To cook by Sensor Cook:

Prepare as above. Cover with plastic wrap. Refer to Vegetables directions on page 24.

SAVOURY BRUSSELS SPROUTS (S) [A]

Serves: 4

Ingredients:

250 g brussels sprouts
2 tablespoons butter
150 g bacon, finely chopped
1 onion, finely chopped
1 teaspoon dill or basil
1 teaspoon sugar

Method:

Wash and drain brussels sprouts. Cook in a covered 2-litre casserole dish on P10 for 4 to 5 minutes.

To cook by Sensor Cook / Auto Cook:

Prepare as above. Cover with plastic wrap. Refer to Vegetables directions on page 24.

Drain and set aside. Place remaining ingredients in separate 2-litre casserole dish. Cook on P10 for 3 to 5 minutes. Add brussels sprouts and cook on P10 for 1 to 2 minutes. Serve.

VEGETABLE FRITTATA

Serves: 4 to 6

Ingredients:

400 g potatoes, thinly sliced
1/2 red capsicum, sliced into strips
1/2 green capsicum, sliced into strips
1 tomato, diced
2 tablespoons fresh basil, chopped
4 eggs
1/3 cup sour cream
1/2 teaspoon cracked black pepper
1/2 cup grated tasty cheese

Method:

Place potatoes in a 2-litre shallow dish. Cook on P10 for 5 to 7 minutes. Arrange capsicum in a circular pattern on top of potato sprinkle with tomato and basil. Beat together eggs and sour cream in a jug. Pour over vegetables. Cook on P6 for 3 to 5 minutes. Sprinkle with pepper and cheese and cook on P6 for 7 to 9 minutes.

HONEY GLAZED CARROTS AND SUGAR SNAP PEAS (S) [A]

Serves: 4 to 6

Ingredients:

350 g carrots (approximately 4)
150 g sugar snap peas, trimmed
2 tablespoons brown sugar
2 teaspoons butter
2 tablespoons honey
1 tablespoon toasted sesame seeds

Method:

Peel and thinly slice carrots. Combine all ingredients in a 2-litre casserole dish. Cover and cook on P10 for 6 to 8 minutes, stirring halfway through cooking. Serve.

To cook by Sensor Cook / Auto Cook:

Prepare as above. Cover with plastic wrap. Refer to Vegetables directions on page 24.

PARMESAN ASPARAGUS

Serves: 2 to 4

Ingredients:

1 bunch of asparagus spears
2 tablespoons water
1 tablespoon butter
1 clove garlic, crushed
1 tablespoon grated Parmesan cheese

Method:

Place asparagus and water in 2-litre casserole dish. Cover and cook on P10 for 1 to 2 minutes. Drain. Place butter and garlic in small dish and cook on P10 for 1 minute. Add drained asparagus and mix lightly. Cook on P10 for a further 1 minute. Sprinkle Parmesan cheese over asparagus. Serve.



Honey Glazed Carrots and Sugar Snap Peas

Cooking Rice by Micro power

Follow directions in chart for recommended dish size, amounts of water and cooking time. Add rice to water. Add salt and butter according to package directions. Cook on P10 for time recommended in

chart. Allow to stand, covered, before serving. For special rice, substitute beef or chicken stock for water. Add cooked onion, mushrooms or crumbled bacon before serving.

ITEM	CONTAINER	AMOUNT OF TAP WATER	APPROX. TIME TO COOK RICE on P10 UNCOVERED (in minutes)	STANDING TIME (in minutes)
RICE				
Quick Cook Brown (1 cup)	2-litre dish	1 $\frac{1}{3}$ cups	10 to 12	5
Brown (1 cup)	4-litre dish	3 cups	25 to 30	10
Long Grain (1 cup)	3-litre dish	2 cups	12 to 14	5
Short Grain (1 cup)	3-litre dish	2 cups	12 to 14	5

Cooking Rice by Sensor Cook (S) / Auto Cook **A**

- **Minimum weight 1 cup / Maximum weight 2 $\frac{1}{2}$ cups**
- Suitable for cooking short and long grain rice including specialty rices.
- It is not suitable for cooking brown rice or wild rice.
- Place rice with water (at room temperature) in a suitable dish. We recommend the following proportions of rice to tap water:

Rice	Water	Dish Size
1 cup	2 cups	3 litre
1 $\frac{1}{2}$ cups	3 cups	3 litre
2 cups	4 cups	4.5 litre
2 $\frac{1}{2}$ cups	5 cups	4.5 litre

It may be necessary to adjust the water to your personal preference.

- Using a large size dish will prevent the rice from boiling over.
- Do not cook rice in plastic dishes as incorrect cooking times may result.
- At the completion of the cooking time, let stand 5 to 10 minutes.

Sensor Cook (S):

- Cover dish securely with plastic wrap.
- During cooking, the oven will 'beep' and instruct you to stir and 'REMOVE COVER'. Remove the plastic wrap and stir. There is no need to cover the rice again.

To Operate: Select **Rice**, then press **Start**.

Auto Cook **A** :

- Leave dish uncovered.

To Operate: Press **Auto Cook to Rice**. Select the serving / weight, then press **Start**.

FRAGRANT COCONUT RICE (S) **A**

Serves: 4 to 6

Ingredients:

1	onion, chopped
2 cups	long grain rice
500 ml	chicken stock
400 ml	coconut milk
1 teaspoon	turmeric

Recipe Prompting

Method:

Place all ingredients in a 3-litre casserole dish. Stir. Cook on P10 for 15 to 18 minutes. Cover and let stand 10 minutes before serving.

To cook by Sensor Cook / Auto Cook:

Prepare as above. Refer to Rice directions on page 29.

SEASONED RICE (S) **A**

Serves: 4 to 6

Ingredients:

1	onion, chopped
1 cup	long grain rice
1 teaspoon	thyme
1 $\frac{1}{2}$ cups	chicken stock
$\frac{1}{4}$ cup	toasted slivered almonds

Method:

Place onion, rice, thyme and chicken stock in a 3-litre casserole dish. Cook on P10 for 14 to 16 minutes. Stir, cover, and let stand for 10 minutes. Stir through slivered almonds and serve hot.

To cook by Sensor Cook / Auto Cook:

Prepare as above. Refer to Rice directions on page 29.

PAELLA

Serves: 6 to 8

Ingredients:

500 g	mussels
¼ cup	water
1	green capsicum, sliced
1	red capsicum, sliced
1	onion, sliced
1	clove garlic, crushed
2 tablespoons	butter
2 cups	long grain rice
400 g	can chopped tomatoes
2 cups	hot chicken stock
	pinch saffron powder
1½ cups	cooked diced chicken
200 g	peeled green prawns

Method:

Place mussels and water in a 3-litre dish. Cover and cook on P7 for 3 to 5 minutes. Set aside. Place capsicum, onion, garlic and butter into 4-litre dish and cook on P10 for 4 to 5 minutes. Add rice and stir well. Cook on P10 for 2 to 4 minutes. Stir in tomatoes, hot chicken stock and saffron. Cook on P10 for 16 to 18 minutes. Stir in chicken, prawns and mussels. Cook on P7 for 4 to 6 minutes. Stand for 10 minutes before serving.

SALMON KEDGEREE

Serves 4

Ingredients:

1 cup	basmati rice
1½ cups	water
60 g	butter
1	onion, diced
2 tablespoons	mild curry powder
2 tablespoons	lemon juice
4	hard boiled eggs, quartered
400g	can salmon, drained and flaked
	salt and pepper
	parsley, chopped

Method:

Place rice and water in a 2 litre casserole dish. Cook on P7 for 12 minutes. In a separate dish, melt butter on P10 for 1 minute. Add onion and cook on P10 for 1 to 2 minutes. Add curry powder and lemon juice, stir until well combined. Add rice and mix well to coat all the rice grains. Chop half the eggs roughly and stir through the rice with the salmon. Season. Heat on P 10 for 3 to 4 minutes. Serve garnished with remaining egg and chopped parsley

FRIED RICE

Serves: 4

Ingredients:

1 tablespoon	sesame oil
1	clove garlic, crushed
1 cm	piece of green ginger, finely chopped
1	small carrot, finely chopped
1	stick celery, sliced
½	green or red capsicum, cut in strips
2	eggs
4	green onions, chopped
	black pepper
1	small can prawns
1 tablespoon	soy sauce
6 cups	cooked rice

Method:

Place oil, garlic and ginger in a large shallow dish and cook on P10 for 30 to 40 seconds. Add carrot, celery and capsicum. Cook a further 2 minutes on P10. Break eggs into a small dish, add pepper to taste, mix well and cook on P7 for 1 to 1½ minutes. Slice into thin strips. Add eggs plus all remaining ingredients to vegetable mixture. Stir well and cook on P10 for 3 to 5 minutes to heat thoroughly. Serve.

Note: 1 cup uncooked rice will yield 2 cups cooked rice. Rice can be cooked using **Sensor Cook** and **Auto Cook** functions.

CHICKEN RISOTTO

Serves: 4

Recipe Prompting

Ingredients:

1	onion, sliced
2 cups	short grain rice
1 teaspoon	dried oregano
1 teaspoon	cracked black pepper
4 cups	chicken stock
¼	green capsicum, sliced
¼	red capsicum, sliced
200 g	mushrooms, sliced
½ cup	frozen peas
2	cooked chicken breast fillets, sliced
¼ cup	grated parmesan cheese

Method:

Place onion, rice, oregano, pepper and chicken stock into a 4-litre dish. Cook on P10 for 17 to 19 minutes. Add remaining ingredients, stir well and cook on P10 for 4 minutes. Serve.

HINT:

TO REHEAT 2 CUPS OF COOKED RICE:

Add 1 to 2 tablespoons of water or a knob of butter and cook on P10 for 2 to 3 minutes.

Cooking Pasta by Micro power

Follow directions in chart for recommended dish size, amount of water and cooking time. Boil water, with 1 teaspoon salt and 1 tablespoon oil. Add pasta and cook for time recommended in chart. Cook on

P10. Test pasta for desired cooking before adding more time. Slightly undercook pasta that will be heated again in casserole. Stir and let stand, uncovered, 5 minutes.

ITEM	CONTAINER	AMOUNT OF BOILING WATER	APPROX. TIME TO COOK PASTA on P10 UNCOVERED (in minutes)	STANDING TIME (in minutes)
Dried Fettuccine (250 g)	4-litre dish	6 cups	10 to 12	5
Elbow Macaroni, shells, etc. (250 g)	3-litre dish	4 cups	12 to 14	5
Fresh Spaghetti, Fettuccine (375 g)	4-litre dish	6 cups	6 to 8	5
Dried Spaghetti (250 g)	4-litre dish	4 cups	12 to 14	5
Fresh Tortellini, Ravioli (250 g)	4-litre dish	4 cups	7 to 9	5
Fresh Gnocchi (375g)	4-litre dish	6 cups	6 to 8	5

Cooking Fresh and Dried pasta by Sensor Cook (S) / Auto Cook (A)

Fresh Pasta (250 g - 625 g)

- Suitable for cooking fresh pasta such as fettuccine, tagliatelle, tortellini, ravioli and agnolotti. (Gnocchi should be cooked by manual MICRO POWER.)
- Place pasta in an appropriate size dish with boiling water. Use the above chart as a guide:

Sensor Cook (S):

- Follow directions as for dried pasta as below.

To Operate: Select **Fresh Pasta**, then press **Start**.

Auto Cook (A):

- Follow Auto Cook directions as for dried pasta.

To Operate: Press **Fresh Pasta**, then press **Start**.

Dried Pasta (150 g - 500 g)

- Suitable for cooking dried pasta such as spaghetti, fettuccine, macaroni, penne, spiral and various pasta shapes.
- Place pasta in an appropriate size dish with boiling water. Use the following as a guide:

Pasta	Boiling Water	Dish Size
150g	4 cups	3 litre
250g	5 cups	3 litre
350g	6 cups	4 litre
500g	8 cups	4 litre

- Add 1 tablespoon of oil, if desired, before cooking to prevent pasta from sticking together.
- At the end of the cooking time, cover and let stand for 5 to 10 minutes, if required, before draining.

Sensor Cook (S):

- Cover dish with plastic wrap or a well fitting lid.
- During the cooking time, the oven will 'beep' and instruct you to stir and 'Remove Cover'. Remove plastic wrap or lid and stir.

To Operate: Select **Dried Pasta**, then press **Start**.

Auto Cook (A)

- Leave dish uncovered.
- During cooking, the oven will 'beep' and instruct you to stir.

To Operate: Press **Auto Cook to Dried Pasta**. Select the serving / weight, then press **Start**.

VEGETABLE TORTELLINI (S) (A)

Serves: 3 to 4

Ingredients:

700 g fresh tortellini
8 cups boiling water

Sauce:

2 tablespoons butter
2 tablespoons flour
2 cups milk
1 red capsicum, finely sliced
200 g snow peas, finely sliced
1 teaspoon dried marjoram
1 teaspoon cracked black pepper
1 cup grated tasty cheese
2 tablespoons Parmesan cheese
2 tablespoons chopped parsley

Method:

Place pasta and water in a 4-litre casserole dish. Cover. Cook on P10 for 12 to 14 minutes, or cook by **Sensor Cook / Auto Cook**. While pasta is cooking, prepare all ingredients for sauce. When pasta is cooked, allow to stand covered. Drain well. Place butter and flour in a 3-litre casserole dish and cook on P10 for 30 to 40 seconds. Slowly blend in milk. Cook for a further 3 to 4 minutes. Stir once during cooking. Add prepared vegetables, marjoram, pepper and cheese. Cook on P10 for 2 minutes. Drain pasta and mix through sauce. Serve topped with Parmesan cheese and chopped parsley.

PENNE PUTTANESCA

Serves: 4

Ingredients:

500 g	Penne Pasta
2 litres	boiling water
1 tablespoon	olive oil
3	cloves garlic, crushed
1 teaspoon	dried chilli flakes
1 kg (approx 5)	tomatoes, roughly chopped
200 g	kalamata olives, pitted
8	anchovy fillets, drained and chopped
1/3 cup	capers, drained and rinsed
1/3 cup	flat leaf parsley, chopped
2 tablespoons	finely shredded basil leaves

Method:

Place pasta and boiling water into a 4-litre dish. Stir and cook on P10 for 12 to 14 minutes or until tender. Drain and set aside. Place oil, and garlic into a 2 litre dish and cook on P10 for 1 minutes. Stir in chilli and tomatoes. Cover and cook on P10 for 5 minutes, stir halfway through cooking. Add remaining ingredients and cook on P10 for a further 10 minutes or until tomatoes break down and sauce has thickened. Stir sauce into pasta. Cover and cook on P10 for 2 to 3 minutes to heat through. Season and serve topped with extra basil leaves or parsley.

CREAMY SUN-DRIED TOMATO PENNE (S) A

Serves: 4

Ingredients:

250 g	penne
6 cups	boiling water
1/2 cup	sun-dried tomatoes in oil, drained
1 cup	basil leaves
1/4 cup	toasted pinenuts
1/3 cup	grated parmesan cheese
300 ml	cream
1/2 cup	sliced ham
1/4 cup	grated parmesan cheese, extra

Method:

Place pasta and water in a 4-litre casserole dish. Cook on P10 for 14 to 16 minutes, or cook by **Sensor Cook / Auto Cook**. While pasta is cooking, prepare sauce. Place all ingredients except ham and extra parmesan cheese in a blender. process until smooth. Drain pasta and add sauce. Serve topped with ham and extra parmesan cheese.

To cook by Sensor Cook / Auto Cook:

Prepare Pasta as above. Refer to Pasta directions on page 31.



Pesto and Fettucine

PESTO AND FETTUCINE (S) A

Serves: 6 to 8

Ingredients:

6 cups	boiling water
250 g	fettucine
2	cloves garlic, crushed
1/2 cup	chopped fresh basil leaves
1 tablespoon	pinenuts, finely chopped
1/2 cup	grated Parmesan cheese
1 cup	olive oil
	salt and black pepper

Method:

Place water in a 3-litre casserole dish. Add fettucine. Cook on P10 for 14 to 16 minutes, or cook by **Sensor Cook / Auto Cook**.

Mix together garlic, basil, nuts and cheese.

Gradually pour in olive oil, stirring constantly.

Season and stir through drained fettucine.

Tip: Olive oil may be added to the sauce by placing all ingredients into a food processor and pouring through the opening in a constant fine stream.

To cook by Sensor Cook / Auto Cook:

Prepare Pasta as above. Refer to Pasta directions on page 31.

SPAGHETTI WITH CHILLI TOMATO SAUCE (S) A

Serves: 4

Ingredients:

250 g	spaghetti
4 cups	boiling water
1 tablespoon	olive oil
1	onion, finely chopped
2	cloves garlic, crushed
1 (425 g)	can crushed tomatoes
2 teaspoons	crushed chillies
2 tablespoons	freshly chopped basil
	cracked black pepper

Method:

Place spaghetti and water in a 3-litre casserole dish. Cook on P10 for 12 to 14 minutes, or cook by **Sensor Cook / Auto Cook**.

Stand, covered, for 2 minutes. Drain. Place oil, onion and garlic in a 4-cup jug. Cook on P10 for 1 to 2 minutes. Add tomatoes, chillies, basil and pepper. Stir until combined. Cover and cook on P7 for 10 to 15 minutes, stirring halfway through cooking. Serve with spaghetti.

To cook by Sensor Cook/ Auto Cook:

Prepare Pasta as above. Refer to Pasta directions on page 31.

CREAMY TUNA PENNE (S) 

Serves: 4

Ingredients:

250 g	Penne
4 cups	boiling water
1	medium onion, diced
2 cups	mixed sliced vegetables
1 (240 g)	can tuna, reserve liquid
2 tablespoons	Parmesan cheese
1 tablespoon	dried thyme
1 tablespoon	lemon juice
1/2 cup	sour cream
	cracked black pepper

Method:

Place Penne and water in a large casserole dish. Cook on P10 for 10 to 14 minutes, or cook by **Sensor Cook / Auto Cook**.

Stand, covered, for 2 minutes. Drain. Place onion in a 4-cup jug. Cook on P10 for 50 to 60 seconds. Add mixed vegetables. Cook on P10 for 2 to 3 minutes. Stir in tuna and reserved liquid, add remaining ingredients and stir until combined. Cook on P7 for 2 to 3 minutes. Place pasta in a serving bowl and pour over sauce to serve.

To cook by Sensor Cook / Auto Cook:

Prepare Pasta as above. Refer to Pasta directions on page 31.

CREAMY BACON SAUCE

Makes: Approximately 300 ml

**Ingredients:**

1	onion, chopped
3	bacon rashers, chopped
1 teaspoon	minced garlic
300 ml	cream
1/4 cup	Parmesan cheese
	pepper
2 tablespoons	chopped fresh parsley
1/4 cup	chicken stock

Method:

Place onion, bacon and garlic in a 2-litre casserole dish. Cook on P10 for 4 to 5 minutes. Add cream, Parmesan cheese, pepper, parsley and stock. Mix well. Cook on P10 for 3 to 4 minutes. Serve with cooked Fettuccine.

Cooking Dried Noodles by Micro power

Follow directions in chart for recommended dish size, amount of boiling water and cooking time. Add 1 tablespoon of oil to water to prevent noodles from sticking together. Add noodles and cook for time recommended in chart. Cook noodles on P10. Test

noodles for desired cooking before adding extra time. Slightly undercook noodles that will be cooked again in a stir-fry or recipe. Always drain noodles immediately after cooking or they may overcook on standing.

ITEM	CONTAINER	AMOUNT OF BOILING WATER	APPROX. TIME TO COOK NOODLES on P10 UNCOVERED (in minutes)	INSTRUCTION
2 minute noodles (85 g)	1-litre	500 ml	2 to 3	drain immediately
Long Life Asian Noodles (250 g)	3-litre	1 litre	5 to 6	drain immediately
Rice Vermicelli (125 g)	2-litre	1 litre	3 to 4	drain immediately

Cooking Fresh Noodles by Sensor Cook (S) / Auto Cook 

- **Minimum weight 150 g / Maximum weight 500 g**
- Suitable for cooking fresh noodles such as Hokkien, Singapore, Udon, Soba, Rice noodles.
- Select **Noodles** and boiling water as recommended in chart beside in a suitable size dish.
- Cover securely with plastic wrap.
- The oven will beep during the cooking time and instruct you to stir/remove cover. There is no need to re-cover noodles.
- At the end of cooking time, drain and use as required.

Noodles	Boiling Water	Dish Size
200g	1/4 cup	1-litre
350g	1/4 cup	1.5-litre
500g	1/2 cup	2-litre
800g	1/2 cup	2.5-litre

Sensor Cook:

To Operate: Select **Noodles**, then press **Start**.

Auto Cook:

To operate: Press **Auto Cook to Noodles**. Select the serving / weight, then press **Start**.

HONEY SOY CHICKEN AND NOODLES (S) A

Serves: 4

Ingredients:

500 g	chicken fillets, sliced
¼ cup	soy sauce
2 tablespoons	honey
2 teaspoons	minced garlic
2 cups	finely sliced vegetables
400 g	udon noodles
½ cup	boiling water

Method:

Combine chicken, soy, honey and garlic in a 2-litre bowl marinate for 30 minutes. Cook chicken on P7 for 4 to 5 minutes, stirring once during cooking. Add vegetables and cook on P10 for 2 to 3 minutes. Place noodles and water in a bowl cover with plastic wrap cook on P7 for 1 to 2 minutes. Drain. Toss noodles in with chicken mixture and serve.

To cook Noodles by Sensor Cook / Auto Cook:

Place noodles and boiling water in a bowl, cover with plastic wrap. Refer to Noodles directions on page 33.

TERIYAKI TOFU VEGETABLE NOODLES

Serves: 4

Ingredients:

1 tablespoon	sesame oil
350 g	firm tofu, diced
1	onion, cut into petals
300 g	stir fry vegetables
1 tablespoon	hoisin sauce
1 tablespoon	teriyaki sauce
1 pkt	2 minute noodles
2 cups	boiling water

Method:

Place oil, tofu and onion in a 3-litre dish and cook on P10 for 2 to 3 minutes. Add vegetables and sauces and cook on P10 for 3 to 4 minutes, stirring once during cooking. Place noodles and water in a 2-litre bowl and cook on P10 for 2 minutes. Stir and drain. Toss noodles through tofu and vegetables and serve.

SZECHUAN SALAD NOODLES (S) A**Ingredients:**

350 g	fresh Hokkien Noodles
½ cup	boiling water
250 g	cooked chicken, shredded
½ cup	roasted cashew nuts

Dressing:

4	green onions, finely sliced
2 tablespoons	chopped coriander
2	cloves garlic, minced
2 tablespoons	smooth peanut butter
2 tablespoons	sweet chilli sauce
1 tablespoon	soy sauce
1 tablespoon	sweet sherry
2 teaspoons	sesame oil
2 tablespoons	olive oil
2 tablespoons	chicken stock
10	toasted szechuan peppercorns, ground

Method:

Place noodles in a bowl with boiling water. Cook on P7 for 1 to 2 minutes. Drain and rinse under cold water. Drain well. Combine all dressing ingredients and whisk well. Combine noodles, chicken and cashew nuts and pour over dressing. Toss well to combine. Serve immediately.

To cook Noodles by Sensor Cook / Auto Cook:

Place noodles and boiling water in a bowl, cover with plastic wrap. Refer to Noodles directions on page 33.

SATAY BEEF WITH NOODLES (S) A

Serves: 4

Ingredients:

500 g	rump steak, sliced
1	onion, sliced
1 teaspoon	crushed garlic
½ cup	crunchy peanut butter
¼ cup	sweet chilli sauce
⅔ cup	coconut milk
2 tablespoons	lemon juice
1 teaspoon	sugar
500 g	fresh Singapore noodles
½ cup	boiling water
2	green onions, sliced

Method:

Place steak, onion and garlic in a 3-litre casserole dish cook on P10 for 2 to 2½ minutes. Add remaining ingredients except green onions and noodles and stir until combined. Cook on P10 for 6 to 8 minutes. Stirring halfway through cooking. Place noodles with water in a 2.5-litre dish cover and cook on P7 for 2 to 3 minutes. Drain and rinse under cold water. Drain well. Toss beef mixture through noodles and top with green onions.

To cook Noodles by Sensor Cook / Auto Cook:

Place noodles and boiling water in a bowl, cover with plastic wrap. Refer to Noodles directions on page 33,

Cooking Desserts by Sensor Cook (S)

- Your oven allows you to cook many desserts automatically. See recipes marked S on the following pages and follow these general instructions:
- Suitable for desserts with a total weight between 375 g - 1.5 kg.
- Place prepared desserts in a suitable size dish (approx. $\frac{3}{4}$ full).
- Do not use plastic dishes as incorrect cooking times may result.
- Cover securely with plastic wrap.
- During the cooking time, the oven will 'beep' and instruct you to 'REMOVE COVER'.
- Allow cooked desserts to stand for 10 minutes at the completion of cooking.

APRICOT and RASPBERRY CRISP (S)

Serves: 4 to 6

Ingredients:

1 (850 g)	can apricots, drained
300 g	frozen raspberries
1 cup	plain flour
$\frac{1}{2}$ cup	brown sugar
1 teaspoon	cinnamon
1 cup	pecans, chopped
1 cup	shredded coconut
2 cups	toasted muesli
125 g	butter

Method:

Place apricots and raspberries in the base of a 2-litre casserole dish. Place remaining ingredients (except butter) in a mixing bowl. Melt butter in a 2-cup jug on P10 for 40 to 50 seconds. Combine melted butter with dry ingredients and mix well. Crumble mixture over top of fruit. Cook on P10 for 10 to 12 minutes.

To cook by Sensor Cook:

Prepare as above. Cover with plastic wrap. Select **Desserts**, then **Start**.

STEAMED JAM PUDDING (S)

Serves: 4

Ingredients:

2 tablespoons	jam
100 g	butter
$\frac{2}{3}$ cup	caster sugar
2	eggs
$\frac{3}{4}$ cup	self raising flour
$\frac{1}{4}$ cup	milk

Method:

Spoon jam into bottom of a 2-litre pudding bowl. Cream butter and sugar in a separate bowl until light and fluffy. Add eggs (one at a time), beating well after each addition. Fold in flour alternately with milk. Mix until well combined. Pour mixture over jam. Smooth top and cook on P10 for 6 to 7 minutes. Let stand, covered, for 5 minutes before serving.

To cook by Sensor Cook:

Prepare as above. Cover with plastic wrap. Select **Desserts**, then **Start**.

APPLE CRUMBLE (S)

Serves: 4

Ingredients:

1 (780 g)	can pie apples
$\frac{1}{2}$ cup	rolled oats
$\frac{1}{4}$ cup	plain flour
$\frac{1}{2}$ cup	desiccated coconut
$\frac{1}{2}$ cup	brown sugar
1 teaspoon	cinnamon
60 g	butter

Method:

Place apples in the base of a 1-litre casserole dish. Place remaining ingredients (except butter) in mixing bowl. Melt butter in 2-cup jug on P10 for 40 to 60 seconds. Combine melted butter with dry ingredients and mix well. Spread evenly over apples. Cook on P10 for 5 to 8 minutes.

To cook by Sensor Cook:

Prepare as above. Cover with plastic wrap. Select **Desserts**, then **Start**.

PEACH CRUMBLE (S)

Serves: 6 to 8

Recipe Prompting

Ingredients:

125 g	butter
1 cup	flour
$\frac{1}{2}$ cup	caster sugar
2 cups	toasted muesli
1 cup	shredded coconut
1 teaspoon	cinnamon
1 (810 g)	can peach slices, drained

Method:

Place butter in a 2-litre jug. Cook on P7 for 1 minute. Add flour, sugar, muesli, coconut and cinnamon, stir until combined. Place peaches into a 2-litre casserole dish. Place crumble mixture on top of peaches and cook on P10 for 10 to 12 minutes. Serve with cream or ice cream.

To cook by Sensor Cook:

Prepare as above. Cover with plastic wrap. Select **Desserts**, then **Start**.

APRICOT COBLER (S)

Serves: 4 to 6

Ingredients:

1 (810 g)	can apricot halves, drained
1	packet butter cake mix
$\frac{1}{2}$ cup	toasted coconut
70 g	butter, melted

Method:

Arrange apricot halves on the base of 20 cm casserole dish. Combine cake mix, toasted coconut and butter. Sprinkle cake mixture over peaches. Cook on P10 for 6 to 8 minutes.

To cook by Sensor Cook:

Prepare as above. Cover with plastic wrap. Select **Desserts**, then **Start**.

BUTTERSCOTCH PUDDING (S)

Serves: 4 to 6

Ingredients:

1 (400 g)	can sweetened condensed milk
30 g	butter
1 teaspoon	vanilla essence
1/2 cup	milk
3/4 cup	self raising flour, sifted
1 cup	brown sugar
1/2 cup	hot tap water

Method:

Place condensed milk in a 3-litre casserole dish. Cook on P5 for 5 to 6 minutes, stirring twice during cooking. Stir in butter, vanilla essence and milk. Stir until butter is melted. Cool slightly. Add milk mixture to sifted flour. Mix well. Pour mixture into a 2-litre casserole dish. Sprinkle top with brown sugar and gently pour hot tap water over mixture. Cook on P10 for 5 to 7 minutes.

To cook by Sensor Cook:

Prepare as above. Cover with plastic wrap. Select **Desserts**, then **Start**.

BREAD AND BUTTER PUDDING

Serves: 4 to 6

Ingredients:

1/3 cup	sultanas
1/4 cup	rum
70 g	butter, softened
10	slices fruit loaf
4	eggs
1 1/3 cups	milk
300 ml	cream
1/3 cup	brown sugar

Method:

Grease a 4 cup microwave oven safe dish. Combine sultanas and rum in a small bowl. Heat on P10 for 1 minute. Set aside. Butter both sides of all bread slices. Remove the crusts and cut into triangles. Beat together eggs, milk and cream, add liquid from drained sultanas. Layer one third of the bread evenly over the base of the 4 cup dish. Sprinkle with half the sultanas and one third of the brown sugar. Repeat with another layer of bread, sultanas and brown sugar and top with the remaining bread. Pour about two thirds of the egg mixture over the bread and allow to stand for 20 minutes until the liquid is absorbed. Pour over the remaining egg mixture and sprinkle with brown sugar. Elevate on a microwave safe rack and cook on P3 for 25 to 30 minutes. Allow to stand for 10 minutes before serving with cream or ice cream.

CHOCOLATE SELF SAUCING PUDDING (S)

Serves: 4

Ingredients:

1 cup	self raising flour
1 tablespoon	cocoa powder
1/3 cup	caster sugar
1/2 cup	milk
1 teaspoon	vanilla essence
100 g	chocolate
30 g	butter
3/4 cup	brown sugar
2 tablespoons	cocoa, extra
3/4 cup	water

Method:

Sift flour and cocoa into a 2-litre bowl. Add sugar, milk and vanilla essence. Mix well. Place chocolate and butter in a 2-cup pyrex jug and cook on P7 for 1 to 1 1/2 minutes. Stir and add to mixture. Mix well. Spread mixture into base of a 2-litre casserole dish. Combine brown sugar, cocoa and water in 2-cup jug. Pour evenly over pudding. Cook on P10 for 4 to 6 minutes.

To cook by Sensor Cook:

Prepare as above. Cover with plastic wrap. Select **Desserts**, then **Start**.

BAKED CUSTARD

Serves: 4 to 5

Ingredients:

425 ml	milk
3	eggs, lightly beaten
1/4 cup	sugar
1 teaspoon	vanilla essence
	pinch ground nutmeg

Method:

Place milk in a 4-cup glass jug. Cook on P10 for 2 minutes. Add eggs, sugar and vanilla to milk, whisking all the time. Strain mixture into a 20 cm round dish, sprinkle with nutmeg. Cook on P4 for 15 to 17 minutes. Allow to stand, covered, for 5 minutes before serving.

Cakes, Desserts and slices can successfully be cooked in the microwave oven if a few simple rules are followed see individual recipes for instructions.

COOKING CAKES BY MICRO POWER

- The texture of cakes cooked in the microwave oven is not the same as cakes cooked in a conventional oven, but it is a convenient way of cooking cakes.
- Do not use metal cake tins. Plastic dishes and pyrex, give the best results when cooking cakes. Grease the dish and line with paper towel or bake paper to absorb excess moisture.
- Round or oval shaped dishes produce the most even cooking results. Square cakes may need the corners shielded with foil to prevent overcooking.
- Choose light coloured cakes that can be iced or substitute brown sugar for white sugar and sprinkle the top of cake with spices to give a darker appearance.
- Do not fill cake pans more than half full. Microwaved cakes rise substantially more than conventionally cooked cakes.
- Cakes need to be well mixed but do not over beat. Creaming with an electric mixer or food processor is not necessary. Use a fork to mix as the microwave aerates the mixture as it cooks.
- Do not cover cakes as the top will steam.
- Cakes should be removed from the oven just before they look cooked as the cooking process will finish during standing time.
- Chocolate cakes cook slightly faster than plain cakes.
- Cakes containing a large amount of whisked egg white will not cook successfully in the microwave oven.

QUICK MIX CHOCOLATE CAKE

Serves: 4 to 6

Ingredients:

1 cup	self-raising flour
1 cup	caster sugar
2 tablespoons	cocoa
3 tablespoons	butter, softened
2	eggs
1/3 cup	milk

Method:

Sift all dry ingredients into a bowl. Add butter, eggs and milk. Beat with wire whisk for 1 to 2 minutes. Grease 2-litre plastic ring mould and line with paper towel. Pour mixture into mould and cook on P7 for 5 to 7 minutes. Stand, covered, for 5 minutes before turning out. Cool on wire rack.

Tip: To soften butter cook on P5 for 10 to 20 seconds.

HINT:

TO SOFTEN DRIED FRUIT:

Place 1 cup dried fruit into a small bowl. Add 2 tablespoons of water. Cover with plastic wrap and cook on P10 for 2 to 3 minutes.

TO TOAST COCONUT:

Place 1/2 cup of coconut on pyrex pie plate. Cook on P10 for 1 to 2 minutes, stirring occasionally.

PACKET CAKE

Ingredients:

1 packet cake mix (340 g)
Ingredients as recommended by manufacturer.

Method:

Mix cake and other ingredients with a metal spoon. **DO NOT OVERBEAT.** Pour into 20 cm round dish that has been lightly greased and lined with paper. Cook on P8 for 4 to 6 minutes. Stand and allow to cool before removing.

Variations:

- 1 tablespoon jam added to batter before cooking.
- Add 1 cup sour cream to batter and halve water suggested by manufacturer.
- Half a cup chopped nuts, 1/4 cup brown sugar and 1 teaspoon cinnamon. Mix and place on base of cake dish before cooking cake.
- Melt two tablespoons honey and 30 g butter in glass jug on P10 for 30 to 60 seconds. Pour over just baked buttercake. Sprinkle with cinnamon. Serve warm with cream or custard as dessert or serve cold with cream as tea cake.
- A quarter cup of toasted muesli mixed with 1 tablespoon marmalade and placed in the base of the dish.

Tip: Packet cakes are best mixed by hand as the microwave will do the aerating.

SULTANA CAKE

Serves: 4 to 6

Ingredients:

100 g	butter
1 cup	sultanas
1 cup	brown sugar
1 cup	milk
1	egg, beaten
2 cups	self-raising flour

Method:

Place butter, sultanas, brown sugar and milk in heat resistant mixing bowl. Cook on P10 for 3 to 4 minutes. Stir halfway through cooking. Allow to cool. Add egg and flour. Pour batter into base of lined 20 cm round dish. Cook on P6 for 9 to 11 minutes. Let cool, loosely covered, with plastic wrap on wire rack.

HINT:

TO SOFTEN CREAM CHEESE: remove from wrapping. Cook on P3 checking every 30 seconds for softness.

JUICING CITRUS: to release more juice from citrus fruit, heat on P10 for 20 to 30 seconds. Stand then juice.

MOCHA CARROT CAKE

Serves: 4 to 6

Ingredients:

1 cup	self-raising flour
1/2 teaspoon	bicarbonate of soda
1/2 cup	caster sugar
1/2 cup	crushed pineapple
1 cup	grated carrot
3/4 cup	chopped pecan nuts
60 g	chocolate
2	eggs
1/3 cup	oil

Icing

60 g	cream cheese
20 g	butter
1 1/2 cups	icing sugar
1 tablespoon	lemon juice
1/4 cup	chopped pecan nuts

Method:

Place flour, bicarbonate of soda, sugar, pineapple, carrot and pecan nuts in a bowl. Place chocolate into a small bowl and cook on P5 for 40 to 60 seconds. Stir halfway through. Add melted chocolate, eggs and oil to flour mixture. Mix until well combined. Grease a microwave safe ring dish. Pour cake mixture into dish and cook on P7 for 6 to 8 minutes. Let stand, covered, for 5 minutes before turning out to cool. Beat together all icing ingredients except pecan nuts. Spread icing over cooled cake and sprinkle with pecan nuts.

BANANA LOAF

Serves: 4 to 6

Ingredients:

90 g	butter
3/4 cup	brown sugar
1	egg
2	ripe bananas, mashed well
3/4 cup	grated carrot
1 1/2 cups	self-raising flour
1/3 cup	milk

Method:

Cream butter and sugar until light and fluffy. Add egg and beat well. Add banana and carrot. Add sifted flour and milk to mixture alternately. Mix until well combined. Grease and line with grease proof paper, 20 cm x 10 cm loaf dish. Pour batter into dish and cook on P6 for 6 to 8 minutes. Stand, covered, with plastic wrap on wire rack to cool.

Tip: To prevent corners from overcooking, cover ends carefully with foil.

TIRAMISU

Serves 4 to 6

Ingredients:

1 tablespoon	ground coffee beans
2 tablespoons	rum
500 g	pkt sponge finger biscuits
3	eggs, separated
2 tablespoons	sugar
100 g	dark chocolate
500 g	marscapone cheese
2 tablespoons	cocoa

Method:

Prepare 2 cups of slightly sweetened espresso coffee using ground coffee beans. Place coffee and rum into a wide bowl and quickly dip sponge biscuits into the mixture, making sure they are wet but not dripping. Set aside. Melt chocolate on P5 for 1 to 1 1/2 minutes. Allow to cool slightly. Beat together egg yolks and sugar and add the marscapone cheese, stir until smooth. Beat the egg whites until they hold stiff peaks and fold into the cheese mixture. Swirl chocolate through the cheese mixture. Arrange 1/3 of the sponge biscuits into the base of a dish top with 1/2 the cheese mixture, repeat layers ending with biscuits. Cover and refrigerate for at least 5 hours. Dust liberally with cocoa before slicing to serve.

CHOCOLATE MOUSSE

Serves: 4

Ingredients:

125 g	dark chocolate
1 tablespoon	brandy
2	eggs, separated
300 ml	cream, whipped

Method:

Break chocolate into small pieces. Place in a microwave safe bowl and cook on P5 for 1 to 1 1/2 minutes. Add brandy and egg yolks. Beat until smooth. Fold cream into chocolate mixture. Beat egg whites until stiff peaks form. Gently fold into chocolate mixture and spoon into one large or 4 individual serving dishes. Refrigerate until set.

BAKED APPLES

Serves: 4

Ingredients:

4	large cooking apples
3 tablespoons	butter
4 tablespoons	brown sugar
100 g	chopped raisins
2 tablespoons	chopped pecans
4 tablespoons	golden syrup

Method:

Score the skin around the middle of the apple. Cream butter and sugar until soft. Add raisins and pecans. Fill the centre of apples with stuffing. Place into shallow casserole dish. Pour one tablespoon of golden syrup over each apple. Cook on P10 for 7 to 9 minutes or until soft. Let stand, 2 to 3 minutes, before serving.



Christmas Pudding

INDIVIDUAL CHRISTMAS PUDDING

Makes: 8

Ingredients:

100 g	sultanas
150 g	raisins
50 g	craisins
100 g	dates, chopped
100 g	dried figs, chopped
50 g	glace ginger, chopped
1/2 cup	brandy
125 g	butter
3/4 cup	firmly packed brown sugar
2	eggs
1/2 teaspoon	cinnamon
1/2 teaspoon	mixed spice
1/2 teaspoon	nutmeg
1/2 cup	plain flour
1/2 cup	pie apple
3/4 cup	fresh breadcrumbs
1 tablespoon	golden syrup
1 tablespoon	parisienne essence

Method:

Place all dried fruits and brandy into a 2-litre bowl. Mix and cook uncovered on P3 for 10 minutes. Stir halfway through cooking. Cool. Beat butter and sugar in a large bowl with an electric mixer until light and fluffy. Add eggs, one at a time, beating between each addition. Stir in cooled fruits, then remaining ingredients. Grease 4 x 200 ml microwave safe cups. Place half a cup of mixture into each cup, pushing mixture in firmly. Smooth over the top of puddings with the back of a spoon. Place cups evenly around the edge of the microwave turntable and cook uncovered on P3 for 20 minutes. Stand for 5 minutes before turning out. Repeat with remaining mixture. Serve with cream or custard.

MINCE PIES • CAUTION

Take care not to overheat mince pies otherwise burning can occur due to the high fat and sugar content of the filling. Check the temperature of the filling before consuming to avoid burning your mouth. REMEMBER even if the pastry is cold to the touch, the filling will be piping hot and will warm the pastry through.

CHOCOLATE PÂT É

Makes 24 x 8 cm loaf tin

Ingredients:

300 g	dark chocolate
400 g	condensed milk
1 cup	brazil nuts
1/2 cup	hazel nuts
1/3 cup	glace cherries
1/2 cup	sultanas

Method:

Break chocolate into pieces and place with condensed milk in a 2-litre dish. Cook on P7 for 3 to 5 minutes, stirring twice during cooking. Fold through nuts and fruits. Line a 24 x 8 cm loaf tin with foil and pour in the mixture. Chill for several hours or until set. Turn out and serve thinly sliced.

FRUIT MINCE

Serves: 4

Ingredients:

250 g	mixed dried fruit
1 (440 g)	can crushed pineapple and juice
1	cooking apple peeled, cored and grated
1 cup	brown sugar
1 tablespoon	brandy
1 teaspoon	nutmeg
1 teaspoon	cinnamon
1 tablespoon	cornflour
1/4 cup	water

Method:

Combine all ingredients (except cornflour and water) in a 2-litre casserole dish. Cook on P7 for 3 to 5 minutes. Blend cornflour with water and stir into fruit mixture. Cook on P10 for 3 to 5 minutes. Stir. Cool. Bottle and seal or use immediately.

CHOCOLATE BROWNIES

Makes: 1 x 20 cm
square slice pan

Recipe Prompting

Ingredients:

125 g	butter
200 g	chocolate
1 cup	caster sugar
1 teaspoon	vanilla essence
2	eggs
1 cup	plain flour

Method:

Grease and line a 20 cm square pyrex dish. set aside. Melt butter and chocolate in a 2-litre dish on P7 for 1½ minute. Stir in sugar, vanilla essence, eggs and flour. Spread into prepared dish. Cook on P7 for 7 to 8 minutes. Refrigerate until cold. Cut into squares.

CHOCOLATE PEANUT BUTTER SQUARES

Makes: one 30 x 20 cm Dish

Ingredients:

60 g	butter
½ cup	brown sugar
1½ cups	icing sugar
1 cup	peanut butter
1 cup	crushed nuts

Topping:

200 g	dark chocolate
20 g	butter

Method:

Foil line and grease a 30 x 20 cm pan. Set aside. Place butter in a 2 litre dish. Soften on P5 for 10 to 20 seconds. Add brown sugar, icing sugar, peanut butter and crushed nuts. Mix until combined. Press into the base of the prepared pan.

To prepare topping:

Place chocolate and butter into a small bowl. Cook on P7 for 1 to 2 minutes. Stir halfway through cooking. Spread over top of prepared base. Refrigerate until cold and cut into squares.

CHOCOLATE FUDGE

Makes: 1 x 20 cm square slice

Recipe Prompting

Ingredients:

300 g	chocolate pieces
1 (400 g)	can condensed milk
1 cup	chopped peanuts

Method:

Grease 20 cm square dish. Set aside. Place chocolate and condensed milk in a 1-litre jug. Cook on P7 for 2 minutes. Stir. Cook on P5 for 2 minutes. Add nuts and place in prepared dish. Refrigerate and cut into squares when cold.

ROCKY ROAD

Makes: 1 x 20 cm square slice

Ingredients:

250 g	dark or milk chocolate
40 g	butter
250 g	packet marshmallows, halved
1 cup	unsalted peanuts
1½ cups	flaked coconut
100 g	turkish delight, chopped

Method:

Melt chocolate and butter in a large bowl on P6 for 2 to 3 minutes. Add remaining ingredients and mix well. Pour into a greased 20 cm square pan. Refrigerate until set. Cut or break into pieces to serve.

MOCHA FUDGE

Makes: 64 x 2.5 cm square pieces

Ingredients:

395 g	can sweetened condensed milk
300 g	dark chocolate melts
1 teaspoon	vanilla extract
1 teaspoon	instant coffee powder
64 (130 g)	chocolate coated coffee beans

Method:

Grease a square (20 cm) cake pan, set aside. Place condensed milk and chocolate in a 1.5-litre microwave safe and heatproof bowl. Cook on P7 for 2 minutes. Stir in vanilla and coffee. Mix until well combined. Cook on P5 for 2 minutes. Stir and pour into prepared pan. Arrange coffee beans evenly over the fudge. Chill for 2 hours or until set. Cut into 2.5 cm squares to serve.

Tip:

Chocolate coated coffee beans are available from specialty coffee shops.

ORANGE TRUFFLES**Ingredients:**

200 g	dark chocolate bits
30 g	butter
¼ cup	evaporated milk
⅓ cup	icing sugar, sifted
¼ cup	chopped nuts
1 tablespoon	orange liqueur
½ cup	drinking chocolate powder

Method:

Place chocolate bits and butter in a 1-litre dish. Cook on P7 for 1 to 2 minutes, stirring halfway through cooking. Add evaporated milk, stir until combined. Stir in icing sugar, nuts and orange liqueur. Refrigerate covered for 1 hour. Roll tablespoons mixture into small balls. Toss in drinking chocolate powder. Refrigerate until serving.

Cooking Fruit by Micro Power

FRUIT - Peel, slice, chop into even sized pieces. Place in shallow heatproof dish on turntable.				
Apples - poached	500 g	P10	8	Add 300 ml of water. Only half fill dish. Cover.
Apples - stewed	500 g	P10	6	Only half fill dish. Cover.
Peaches - poached	500 g	P10	4 - 5	Add 300 ml of water. Only half fill dish. Cover.
Pears - poached	500 g	P10	6 - 7	Add 300 ml of water. Only half fill dish. Cover.
Plums - poached	500 g	P10	6	Add 300 ml of water. Only half fill dish. Cover.
Plums - stewed	500 g	P10	6 - 10	Add 30 ml of water. Only half fill dish. Cover.
Rhubarb - stewed	500 g	P10	5	Only half fill dish. Cover.

CHERRY KUECHEN

Serves: 4 to 6

Ingredients:

Base:

1 pkt (340 g) buttercake mix
 1/2 cup toasted coconut
 125 g melted butter
 1 egg

Filling:

425 g can pitted cherries, drained

Topping:

300 ml sour cream
 1 egg
 2 tablespoons sugar
 cinnamon

Method:

Combine cake mix, coconut, melted butter and egg. Press into a 27 cm flan dish. Cook on P10 for 3 minutes. Arrange cherries over base. Combine sour cream, egg and sugar and pour over cherries. Sprinkle with cinnamon. Cook on P6 for 10 to 12 minutes.

HINT:

TO MELT CHOCOLATE:

Place 100 g broken chocolate in 4-cup glass jug and heat on P5 for 1 to 2 minutes. As chocolate holds its shape after heating, stir and stand before adding extra cooking time.

HINT:

TO TOAST COCONUT:

Place 1/2 cup of coconut on a pyrex pie plate. Cook on P10 for 2 to 3 minutes. Stirring occasionally.

CINNAMON POACHED PEARS

Serves: 4

Recipe Prompting

Ingredients:

1/2 cup water
 1/4 cup caster sugar
 1/2 teaspoon cinnamon
 4 pears, peeled and sliced

Method:

Combine water, caster sugar and cinnamon in a 1-litre jug. Cook on P10 for 2 minutes. Place the pears in 2-litre dish. Pour over syrup and cover. Cook on P10 for 6 to 8 minutes.

SWEET BERRY SAUCE

Makes: Approximately 2 cups

Recipe Prompting

Ingredients:

1/2 cup caster sugar
 1/2 cup water
 500 g berries
 2 tablespoons water
 1 tablespoon cornflour

Method:

Combine sugar and water in a 3-litre bowl. Cook on P10 for 2 to 3 minutes. Add berries. Cook on P10 for 3 to 4 minutes. Blend water and cornflour. Mix into berry sauce. Cook on P10 for 2 minutes. Serve hot or cold with ice cream.

Preserving

Precautions:

Do not use your oven for home canning or the heating of any closed jar. Pressure will build up and the jar may explode. In addition, the microwave oven cannot maintain the food at the correct canning temperature. Improperly canned food may spoil and be dangerous to consume.

Jars and Bottles

Jars and bottles can be used to warm food to serving temperature. If the lid is removed first. Cooking should not be done in these containers since most are not heat resistant and during extended heating times, heat from food would cause cracking or breaking.

Thermometers are available for use in microwave oven. **DO NOT USE CONVENTIONAL MERCURY TYPE CANDY OR MEAT THERMOMETERS** in food while cooking in the microwave oven.

Alternatively, a conventional meat thermometer may be used after the food is removed from the oven.

Sterilizing Jars

Jam jars can be sterilized by microwave ready for your jams. Half fill with water and heat them on HIGH power until water boils (approx. 3 mins, for 2 jars). Empty and drain upside down on kitchen paper. The jars should be warm when filled with jam.

TOMATO CHUTNEY

Makes: 3 cups (750 ml)

Ingredients:

250 g	onion, finely chopped
1.5 kg	ripe tomato, skins removed and chopped
1 teaspoon	salt
1 teaspoon	paprika
	pinch cayenne pepper
150 ml	malt vinegar
175 g	sugar

Method:

Place onions in a 3-litre dish. Cover. Cook on P10 for 4 to 5 minutes. Add tomatoes. Cover. Cook on P10 for 5 to 6 minutes. Add salt, spices and vinegar. Stir well. Cook on P10 for 10 minutes, stirring halfway through. Add sugar, stir well and cook on P7 for 35 to 40 minutes. Stirring occasionally. Pour into sterilised jars and seal.

CUCUMBER PICKLE

Ingredients:

2	cucumbers
2	onions, chopped
2 tablespoons	salt
250 ml	malt vinegar
$\frac{2}{3}$ cup	sugar
$\frac{1}{2}$ teaspoon	celery seeds
$\frac{1}{2}$ teaspoon	mustard seeds

Method:

Wash cucumbers and remove ends, dice (do not peel). Place diced cucumber in a bowl. Add onion and sprinkle with salt. Stand overnight. Rinse and drain cucumbers and onions. Pack into sterilised jars. Place remaining ingredients in jug and cook on P10 for 2 minutes. Stir and cook on P10 for a further 5 minutes. Pour liquid over cucumber and seal. Keep for 4 weeks before opening.



Lemon Lime Cordial

SWEET APRICOT JAM

Makes: Approximately 1.5 litres

Ingredients:

500 g	dried apricots, cut in quarters
1.2 litres	water
850 g	sugar
2 tablespoons	pectin

Method:

Place apricots and water in a 4-litre casserole dish. Cover and allow to stand overnight. Add sugar. Re-cover. Cook on P7 for 25 minutes, stirring halfway through cooking. Remove lid, add pectin, stir well. Cook on P7 for a further 25 minutes, stirring halfway through cooking. Allow to cool slightly before pouring into sterilised jars. Seal.

LEMON BUTTER

Makes: 1 cup (250 ml)

Ingredients:

$\frac{1}{2}$ cup	lemon juice
1 tablespoon	lemon rind
$\frac{1}{3}$ cup	sugar
3	egg yolks
1 tablespoon	butter
1 tablespoon	cornflour

Method:

Blend all ingredients in a 4-cup glass jug. Cook on P6 for 4 to 5 minutes, stirring every minute. Pour into hot sterilised jars and seal immediately.

LEMON LIME CORDIAL

Makes: approximately 1.5 litres of undiluted cordial

Ingredients:

10	large lemons
6	limes
4 cups	sugar
2 cups	water
2 teaspoons	citric acid

Method:

Squeeze juice from lemons and limes. Place in a 4-litre dish with the remaining ingredients. Cook on P10 for 8 to 10 minutes. Stir 2 to 3 times during this cooking time to dissolve sugar. Cook for a further 25 to 30 minutes, or until the mixture has become a syrupy consistency. Set aside to cool. Pour into bottles and seal. Store in the refrigerator and serve with cold water, soda or mineral water and fresh mint leaves if desired.

BASIC WHITE SAUCE

Makes: 1½ cups

Ingredients:

2 tablespoons butter
 2 tablespoons flour
 salt and white pepper
 1½ cups milk

Method:

Place butter in a 4-cup jug. Cook on P10 for 30 to 40 seconds. Stir in flour, salt and pepper. Gradually add milk, stirring until smooth. Cook on P10 for 2 minutes, stirring every minute.

Tip: For cheese sauce, stir in ½ cup grated cheese once sauce has thickened.

GRAVY

Makes: 2 cups

Ingredients:

2 tablespoons dripping or pan juice
 1 small onion, finely chopped
 2 tablespoons flour
 1 tablespoon tomato paste
 1½ cups beef stock
 salt and pepper

Method:

Place dripping or pan juice and onion in a 2-cup jug. Cook on P10 for 2 minutes. Add flour, tomato paste and half of the beef stock. Stir well. Cook on P10 for 2 minutes. Add remaining stock. Stir well and cook on P10 for a further 2 minutes. Season with salt and pepper. Serve with the meat of your choice.

CHEESE SAUCE

Make :1½ cups

*Recipe Prompting***Ingredients:**

40 g butter
 2 tablespoons flour
 1½ cups milk
 ½ cup grated cheese

Method:

Melt butter in a 1-litre jug on P10 for 30 seconds. Add flour and mix well. Gradually stir in milk. Cook on P10 for 2 to 3 minutes. Stirring halfway through cooking. Add cheese and cook on P10 for a further 1 to 1½ minutes. Stir and serve with vegetables for your choice.

HINT:**COOKING SAUCES:**

When making some sauces in the microwave oven, less liquid maybe needed as less evaporation occurs with a shorter cooking time.

MINT SAUCE

Make: Approximately ¼ cup

Ingredients:

¼ cup water
 1 tablespoon sugar
 2 tablespoons brown vinegar
 2 tablespoons mint, finely chopped

Method:

Combine all ingredients in a 1-cup jug. Cook on P10 for 30 to 60 seconds. Stir well and serve with Roast Lamb.

CARAMEL SAUCE

Makes: 2 cups

Ingredients:

440 g can condensed milk
 ¼ cup brown sugar
 2 tablespoons golden syrup
 300 ml cream

Method:

Combine condensed milk, brown sugar and golden syrup in a 2-litre jug. Mix well. Cook on P10 for 4 to 5 minutes, stirring halfway through cooking. Add cream and stir until combined. Serve over ice cream.

RICH CHOCOLATE SAUCE

Makes: 1¼ cups

*Recipe Prompting***Ingredients:**

200 g chocolate pieces
 300 ml cream

Method:

Combine chocolate and cream in 1-litre jug. Cook on P10 for 2 minutes. Mix well. Serve over ice cream.

STIRRED CUSTARD

Makes: Approximately 400 ml

Ingredients:

3 tablespoons sugar
 2 tablespoons custard powder
 1½ cups milk
 2 egg yolks, lightly beaten
 1 teaspoon vanilla essence

Method:

Combine sugar and custard powder in a 4-cup jug. Gradually stir in milk until smooth. Cook on P6 for 4 to 5 minutes, stirring halfway through cooking. Add egg yolks and mix well. Cook on P6 for further 30 to 60 seconds. Add vanilla, stir well and serve.

HINT:**TO REHEAT POURING CUSTARD:**

Place 600 ml in a 1-litre jug and cook on P10 for 2 to 3 minutes stirring once.

COFFEE

Serves: 1

Ingredients:

1 cup water
1 to 2 teaspoons instant coffee

Method:

Pour water into a heatproof cup. Add coffee. Stir. Heat on P10 for 1 to 2 minutes. Add milk and sugar, if desired. Stir.

TEA

Serves: 1

Ingredients:

$\frac{3}{4}$ cup hot tap water
1 tea bag

Method:

Pour water into a heatproof cup. Heat on P10 for 1 to 2 minutes. Stir then submerge tea bag in water. Stand until desired strength is reached. Remove tea bag. Add milk and sugar, if desired. Stir.

HOT CHOCOLATE

Serve: 1

Ingredients:

1 tablespoon choc bits
250 ml milk

Method:

Place choc bits in the base of a mug add milk. Cook on P7 for 1 to 2 minutes, stirring half way through cooking. Stir and serve.

PEPPERMINT COOLER

Serves: 4

Ingredients:

3 peppermint tea bags
4 cups cold water
juice of $\frac{1}{2}$ lemon
ice blocks
4 slices lemon or lime
mint leaves to garnish

Method:

Place tea bags and water in a large jug. Cook on P10 for 8 to 10 minutes. Stand for 2 to 3 minutes, then discard tea bags. Cool. Add lemon juice. Refrigerate until well chilled. Serve in long glasses with ice blocks. Garnish with lemon or lime slices and mint leaves.

GINGER TEA

Serve: 2

Ingredients:

5 cm piece ginger
1 lemon, sliced
2 teabags
1 cup mint leaves
2 cups water

Method:

Peel and slice ginger and place into a 2-cup jug with remaining ingredients. Heat on P10 for 3 to 4 minutes. Allow standing for 5 minutes to infuse. Strain and serve.

STRAWBERRY LIQUEUR

Makes: 1 litre

Ingredients:

500 g sugar
500 g washed and hulled strawberries
600 g brandy or whisky

Method:

Place sugar and strawberries in a 4-litre dish. Stir well. Cook on P10 for 15 minutes. Stir in brandy or whisky. Pour into an airtight container. Store refrigerated for 2 to 3 months. Serve in liqueur glasses or as a tall drink with ice cubes and soda water.

COFFEE LIQUEUR

Makes: 750 ml

Ingredients:

$1\frac{1}{2}$ cups hot tap water
2 cups sugar
 $\frac{1}{3}$ cup freeze dried coffee
3 teaspoons vanilla essence
2 cups vodka

Method:

Pour water into a 4-litre casserole dish. Add remaining ingredients (except vodka) and stir well. Cook on P6 for 30 to 35 minutes. Cool slightly and mix in vodka. Pour into an airtight container and stand 4 days before serving. Serve in liqueur glasses.

HOT LEMON AND HONEY DRINK

Makes: 1

Ingredients:

juice of $\frac{1}{2}$ lemon
1 tablespoon honey
1 cup water

Method:

Mix all ingredients in a 2-cup heatproof jug. Heat on P10 for 1 to 2 minutes. Stir well.