

SUPERO®

SuperWorkstation 7045A-C3
SuperWorkstation 7045A-CT

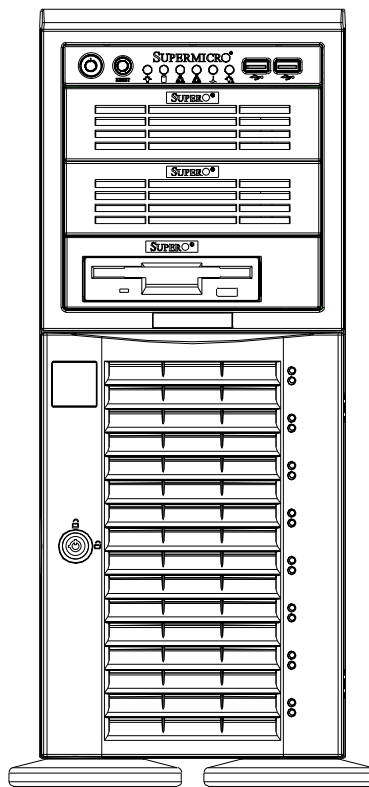

USER'S MANUAL

The information in this User's Manual has been carefully reviewed and is believed to be accurate. The vendor assumes no responsibility for any inaccuracies that may be contained in this document, makes no commitment to update or to keep current the information in this manual, or to notify any person or organization of the updates. **Please Note: For the most up-to-date version of this manual, please see our web site at www.supermicro.com.**

Super Micro Computer, Inc. ("Supermicro") reserves the right to make changes to the product described in this manual at any time and without notice. This product, including software, if any, and documentation may not, in whole or in part, be copied, photocopied, reproduced, translated or reduced to any medium or machine without prior written consent.

IN NO EVENT WILL SUPERMICRO BE LIABLE FOR DIRECT, INDIRECT, SPECIAL, INCIDENTAL, SPECULATIVE OR CONSEQUENTIAL DAMAGES ARISING FROM THE USE OR INABILITY TO USE THIS PRODUCT OR DOCUMENTATION, EVEN IF ADVISED OF THE POSSIBILITY OF SUCH DAMAGES. IN PARTICULAR, SUPERMICRO SHALL NOT HAVE LIABILITY FOR ANY HARDWARE, SOFTWARE, OR DATA STORED OR USED WITH THE PRODUCT, INCLUDING THE COSTS OF REPAIRING, REPLACING, INTEGRATING, INSTALLING OR RECOVERING SUCH HARDWARE, SOFTWARE, OR DATA.

Any disputes arising between manufacturer and customer shall be governed by the laws of Santa Clara County in the State of California, USA. The State of California, County of Santa Clara shall be the exclusive venue for the resolution of any such disputes. Super Micro's total liability for all claims will not exceed the price paid for the hardware product.

This equipment has been tested and found to comply with the limits for a Class B digital device pursuant to Part 15 of the FCC Rules. These limits are designed to provide reasonable protection against harmful interference in a residential installation. This equipment generates, uses, and can radiate radio frequency energy and, if not installed and used in accordance with the manufacturer's instruction manual, may cause interference with radio communications. However, there is no guarantee that interference will not occur in a particular installation. If this equipment does cause harmful interference to radio or television reception, which can be determined by turning the equipment off and on, you are encouraged to try to correct the interference by one or more of the following measures: Reorient or relocate the receiving antenna. Increase the separation between the equipment and the receiver. Connect the equipment into an outlet on a circuit different from that to which the receiver is connected. Consult the dealer or an experienced radio/television technician for help.

WARNING: Handling of lead solder materials used in this product may expose you to lead, a chemical known to the State of California to cause birth defects and other reproductive harm.

Manual Revision 1.0
Release Date: February 15, 2008

Unless you request and receive written permission from Super Micro Computer, Inc., you may not copy any part of this document.

Information in this document is subject to change without notice. Other products and companies referred to herein are trademarks or registered trademarks of their respective companies or mark holders.

Copyright © 2008 by Super Micro Computer, Inc.
All rights reserved.

Printed in the United States of America

Preface

About This Manual

This manual is written for professional system integrators and PC technicians. It provides information for the installation and use of the SuperWorkstation 7045A-C3/7045A-CT. Installation and maintenance should be performed by experienced technicians only.

The SuperWorkstation 7045A-C3/7045A-CT is a high-end server based on the SC743TQ-865-SQ tower/4U rackmount chassis and the X7DCA-3/X7DCA-i, a dual processor serverboard that supports dual Intel® Xeon® LGA771 5400/5300/5200/5100 series processors.

Manual Organization

Chapter 1: Introduction

The first chapter provides a checklist of the main components included with the server system and describes the main features of the X7DCA-3/X7DCA-i serverboard and the SC743TQ-865-SQ chassis, which comprise the SuperWorkstation 7045A-C3/7045A-CT.

Chapter 2: Server Installation

This chapter describes the steps necessary to setup the SuperWorkstation 7045A-C3/7045A-CT into a rack and check out the server configuration prior to powering up the system. If your server was ordered without processor and memory components, this chapter will refer you to the appropriate sections of the manual for their installation.

Chapter 3: System Interface

Refer here for details on the system interface, which includes the functions and information provided by the control panel on the chassis as well as other LEDs located throughout the system.

Chapter 4: System Safety

You should thoroughly familiarize yourself with this chapter for a general overview of safety precautions that should be followed when installing and servicing the SuperWorkstation 7045A-C3/7045A-CT.

Chapter 5: Advanced Serverboard Setup

Chapter 5 provides detailed information on the X7DCA-3/X7DCA-i serverboard, including the locations and functions of connections, headers and jumpers. Refer to this chapter when adding or removing processors or main memory and when reconfiguring the serverboard.

Chapter 6: Advanced Chassis Setup

Refer to Chapter 6 for detailed information on the SC743TQ-865-SQ server chassis. You should follow the procedures given in this chapter when installing, removing or reconfiguring SAS/SATA or peripheral drives and when replacing system power supply units and cooling fans.

Chapter 7: BIOS

The BIOS chapter includes an introduction to BIOS and provides detailed information on running the CMOS Setup Utility.

Appendix A: BIOS POST Messages

Appendix B: BIOS POST Codes

Appendix C: Intel HostRaid Setup Guidelines

Appendix D: System Specifications

Notes

Table of Contents

Chapter 1 Introduction

1-1	Overview	1-1
1-2	Serverboard Features	1-2
	Processors	1-2
	Memory	1-2
	Onboard SAS	1-2
	Serial ATA	1-2
	PCI Expansion Slots	1-2
	Onboard Controllers/Ports	1-3
	Other Features	1-3
1-3	Server Chassis Features	1-3
	System Power	1-3
	SAS Subsystem	1-3
	SATA Subsystem.....	1-3
	Front Control Panel.....	1-3
	I/O Backplane.....	1-4
	Cooling System.....	1-4
1-4	Contacting Supermicro.....	1-6

Chapter 2 Server Installation

2-1	Overview	2-1
2-2	Unpacking the System	2-1
2-3	Preparing for Setup.....	2-1
	Choosing a Setup Location.....	2-2
	Rack Precautions	2-2
	Server Precautions.....	2-2
	Rack Mounting Considerations	2-3
	Ambient Operating Temperature	2-3
	Reduced Airflow	2-3
	Mechanical Loading	2-3
	Circuit Overloading.....	2-3
	Reliable Ground	2-3
2-4	Installing the System into a Rack	2-4
	Identifying the Sections of the Rack Rails.....	2-4
	Installing the Chassis Rails.....	2-5

Installing the Rack Rails	2-6
Installing the Server into the Rack.....	2-7
2-5 Checking the Serverboard Setup.....	2-8
2-6 Checking the Drive Bay Setup.....	2-9
Chapter 3 System Interface	
3-1 Overview	3-1
3-2 Control Panel Buttons	3-1
Power	3-1
Reset.....	3-1
3-3 Control Panel LEDs	3-2
Power	3-2
HDD.....	3-2
NIC1	3-2
NIC2	3-2
Overheat/Fan Fail	3-2
Power Fail	3-3
3-4 Drive Carrier LEDs.....	3-3
SAS Drives.....	3-3
SATA Drives	3-3
Chapter 4 System Safety	
4-1 Electrical Safety Precautions	4-1
4-2 General Safety Precautions	4-2
4-3 ESD Precautions.....	4-3
4-4 Operating Precautions	4-4
Chapter 5 Advanced Serverboard Setup	
5-1 Handling the Serverboard	5-1
Precautions	5-1
Unpacking	5-2
5-2 Serverboard Installation	5-2
5-3 Connecting Cables.....	5-2
Connecting Data Cables	5-3
Connecting Power Cables	5-3
Connecting the Control Panel.....	5-3
5-4 I/O Ports	5-4
5-5 Installing the Processor and Heat Sink	5-5
5-6 Installing Memory	5-9
5-7 Adding PCI Cards	5-11
5-8 Serverboard Details	5-12

X7DCA-3/X7DCA-i Quick Reference	5-13
5-9 Connector Definitions	5-14
5-10 Jumper Settings	5-21
5-11 Onboard Indicators.....	5-23
5-12 Parallel, Floppy, IDE, and SATA Ports.....	5-24

Chapter 6 Advanced Chassis Setup

6-1 Static-Sensitive Devices.....	6-1
Precautions	6-1
Unpacking	6-1
6-2 Front Control Panel.....	6-3
6-3 System Fans	6-4
Fan Failure	6-4
Replacing Chassis Cooling Fans.....	6-4
6-4 Drive Bay Installation	6-6
SAS/SATA Backplane.....	6-7
Installing Components in the 5.25" Drive Bays	6-8
6-5 Power Supply	6-9
Power Supply Failure.....	6-9

Chapter 7 BIOS

7-1 Introduction.....	7-1
7-2 Running Setup	7-2
7-3 Main BIOS Setup	7-2
7-4 Advanced Setup.....	7-7
7-5 Security	7-21
7-6 Boot.....	7-23
7-7 Exit	7-24

Appendix A BIOS POST Messages

Appendix B BIOS POST Codes

Appendix C Intel HostRAID Setup Guidelines

Appendix D System Specifications

Chapter 1

Introduction

1-1 Overview

The 7045A-C3/7045A-CT is a high-end workstation comprised of two main subsystems: the SC743TQ-865-SQ tower/4U server chassis and the X7DCA-3/X7DCA-i dual Intel Xeon processor serverboard. Please refer to our web site for information on operating systems that have been certified for use with the SuperWorkstation 7045A-C3/7045A-CT (www.supermicro.com).

In addition to the serverboard and chassis, various hardware components have been included with the SuperWorkstation 7045A-C3/7045A-CT, as listed below:

- Two (2) 8-cm hot-swap PWM "SuperQuiet" chassis fans (FAN-0104L4)
- One (1) 9-cm PWM "SuperQuiet" exhaust fan (FAN-0103L4)
- Two (2) CPU heat sinks (SNK-P0034AP4)
- One (1) 3.5" floppy drive (FPD-PNSC-01)
- One (1) cable for DVD drive (CBL-0140L)
- One (1) floppy cable (CBL-112L)
- SAS Accessories (7045A-C3)
 - One (1) SAS backplane (CSE-SAS-743TQ)
 - Two (2) SAS cables (CBL-0119L)
 - Six (6) SATA hot-swap drive carriers [CSE-PT17(B)]
- SATA Accessories (7045A-CT)
 - One (1) SATA backplane (CSE-SAS-743TQ)
 - Six (6) SATA cables (CBL-0061L)
 - Two (2) SGPIO cables (CBL-0157L)
 - Six (6) SATA hot-swap drive carriers [CSE-PT17(B)]
- Optional:
 - One (1) 8-cm PWM fan (FAN-0104L)
 - One (1) rackmount kit [CSE-PT26L-(B)]

1-2 Serverboard Features

At the heart of the SuperWorkstation 7045A-C3/7045A-CT lies the X7DCA-3/X7DCA-i, a dual processor serverboard based on the Intel 5100 chipset and designed to provide maximum performance. Below are the main features of the X7DCA-3/X7DCA-i. (See Figure 1-1 for a block diagram of the chipset).

Processors

The X7DCA-3/X7DCA-i supports single or dual LGA771 type Intel Xeon 5400/5300/5200/5100 Series processors at a FSB speed of 1333/1066 MHz. Please refer to the serverboard description pages on our web site for a complete listing of supported processors (www.supermicro.com).

Memory

The X7DCA-3/X7DCA-i has six 240-pin DIMM slots that can support up to 32 GB of ECC DDR2-667/533 SDRAM. The memory operates in an interleaved configuration and requires requires modules of the same size and speed to be installed two at a time. See Chapter 5 Section 5 for details.

Onboard SAS

An onboard LSI 1068 SAS controller is integrated into the X7DCA-3 (only), which supports eight SAS hard drives. The SAS drives are connected to a backplane that provides power, bus termination and configuration settings. These SAS drives are hot-swappable units and support RAID levels 0, 1, 10 and (with iButton) 5.

Note: The operating system you use must have RAID support to enable the hot-swap capability and RAID function of the SAS drives.

Serial ATA

A Serial ATA controller is integrated into the ICH9 (South Bridge) portion of the chipset to provide a six-port 3 Gb/s SATA subsystem, which is RAID 0, 1, 10 and 5 supported. The SATA drives are hot-swappable units.

Note: The operating system you use must have RAID support to enable the hot-swap capability and RAID function of the SATA drives.

PCI Expansion Slots

The X7DCA-3/X7DCA-i has one PCI-Express x16 slot, one PCI-Express x4 (in a x16 slot), two 64-bit 133/100 MHz PCI-X slots, two PCI 33 MHz slots and an IPMI slot.

Onboard Controllers/Ports

One floppy drive connector and one onboard ATA/100 connector are provided to support IDE hard drives or ATAPI devices. The color-coded rear I/O ports include two COM ports, one parallel port, four USB 2.0 ports, PS/2 mouse and keyboard ports, two gigabit Ethernet ports and HDA (High Definition Audio) ports.

Other Features

Other onboard features that promote system health include onboard voltage monitors, a chassis intrusion header, auto-switching voltage regulators, chassis and CPU overheat sensors, virus protection and BIOS rescue.

1-3 Server Chassis Features

The SuperWorkstation 7045A-C3/7045A-CT is a scaleable server platform designed with today's most state-of-the-art features. The following is a general outline of the main features of the SC743TQ-865-SQ server chassis.

System Power

The 7045A-C3/7045A-CT features a single 865W power supply. This power supply unit has been designed to operate at a low noise level to make it ideal for use in a workstation environment.

SAS Subsystem

The SC743TQ-865-SQ chassis was designed to support eight SAS hard drives, which are hot-swappable units (7045A-C3 only).

SATA Subsystem

The SC743TQ-865-SQ supports up to six 3 Gb/s Serial ATA drives. The SATA drives are hot-swappable units and are connected to a backplane that provides power and control.

Front Control Panel

The control panel on the SuperWorkstation 7045A-C3/7045A-CT provides you with system monitoring and control. LEDs indicate system power, HDD activity, network activity, overheat conditions and power supply failure. A main power button and a system reset button are also included.

Note: the power supply fail LED indicates the power supply fan has failed.

I/O Backplane

The SC743TQ-865-SQ is an ATX form factor chassis that can be used as a tower or mounted in a 4U rackmount configuration. The I/O backplane provides seven expansion slots, two COM ports, a parallel port, four USB 2.0 ports, PS/2 mouse and keyboard ports, two Gigabit Ethernet port(s) and 7.1 HDA ports.

Cooling System

The SC743TQ-865-SQ chassis has an innovative "Super Quiet" cooling design that provides sufficient cooling at very low noise level - ideal for a workplace environment. The chassis includes two 8-cm hot-plug PWM (Pulse Width Modulation) system cooling fans located in the middle of the chassis. The system cooling fans work with an air shroud to cool the areas where the most heat is generated. A 9-cm PWM exhaust fan is also located at the rear of the chassis.

The power supply has two fans for redundancy; if one fan fails the other will increase its rpm to compensate. This may cause the system to run louder than usual. See details in Chapter 6.

**Figure 1-1. Intel 5100 Chipset:
System Block Diagram**

Note: This is a general block diagram. Please see Chapter 5 for details.

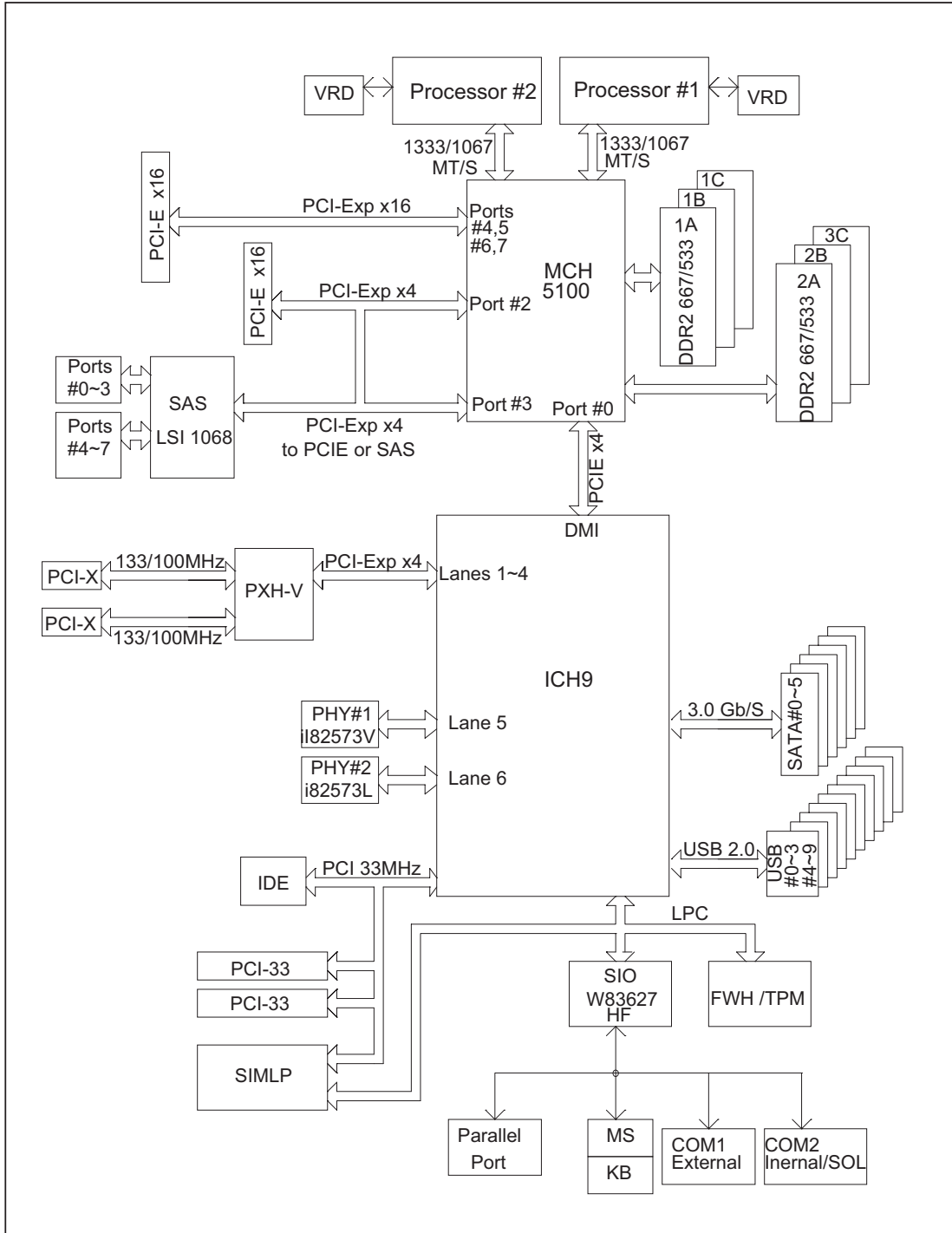

1-4 Contacting Supermicro

Headquarters

Address: Super Micro Computer, Inc.
980 Rock Ave.
San Jose, CA 95131 U.S.A.

Tel: +1 (408) 503-8000

Fax: +1 (408) 503-8008

Email: marketing@supermicro.com (General Information)
support@supermicro.com (Technical Support)

Web Site: www.supermicro.com

Europe

Address: Super Micro Computer B.V.
Het Sterrenbeeld 28, 5215 ML
's-Hertogenbosch, The Netherlands

Tel: +31 (0) 73-6400390

Fax: +31 (0) 73-6416525

Email: sales@supermicro.nl (General Information)
support@supermicro.nl (Technical Support)
rma@supermicro.nl (Customer Support)

Asia-Pacific

Address: Super Micro Computer, Inc.
4F, No. 232-1, Liancheng Rd.
Chung-Ho 235, Taipei County
Taiwan, R.O.C.

Tel: +886-(2) 8226-3990

Fax: +886-(2) 8226-3991

Web Site: www.supermicro.com.tw

Technical Support:

Email: support@supermicro.com.tw

Tel: 886-2-8228-1366, ext.132 or 139

Chapter 2

Server Installation

2-1 Overview

This chapter provides a quick setup checklist to get your SuperWorkstation 7045A-C3/7045A-CT up and running. Following these steps in the order given should enable you to have the system operational within a minimum amount of time. This quick setup assumes that your system has come to you with the processors and memory preinstalled. If your system is not already fully integrated with a serverboard, processors, system memory etc., please turn to the chapter or section noted in each step for details on installing specific components.

The 7045A-C3/7045A-CT may be employed either as a tower or mounted in a rack as a 4U rackmount chassis. If using it as a tower unit, please read the Server Precautions in the next section and then skip ahead to Section 2-5.

2-2 Unpacking the System

You should inspect the box the system was shipped in and note if it was damaged in any way. If the server itself shows damage you should file a damage claim with the carrier who delivered it.

Decide on a suitable location for the SuperWorkstation 7045A-C3/7045A-CT. It should be situated in a clean, dust-free area that is well ventilated. Avoid areas where heat, electrical noise and electromagnetic fields are generated. You will also need it placed near a grounded power outlet. Be sure to read the Rack and Server Precautions in the next section.

2-3 Preparing for Setup

The box the system was shipped in may include two sets of rail assemblies, two rail mounting brackets and mounting screws needed for installing the system into a rack (optional kit). Follow the steps in the order given to complete the installation process in a minimum amount of time. Please read this section in its entirety before you begin the installation procedure outlined in the sections that follow.

Choosing a Setup Location

- Leave enough clearance in front of the rack to enable you to open the front door completely (~25 inches) and approximately 30 inches of clearance in the back of the rack to allow for sufficient airflow and ease in servicing.
- This product is for installation only in a Restricted Access Location (dedicated equipment rooms, service closets and the like).
- This product is not suitable for use with visual display work place devices according to §2 of the the German Ordinance for Work with Visual Display Units.



Warnings and Precautions!



Rack Precautions

- Ensure that the leveling jacks on the bottom of the rack are fully extended to the floor with the full weight of the rack resting on them.
- In single rack installation, stabilizers should be attached to the rack. In multiple rack installations, the racks should be coupled together.
- Always make sure the rack is stable before extending a component from the rack.
- You should extend only one component at a time - extending two or more simultaneously may cause the rack to become unstable.

Server Precautions

- Review the electrical and general safety precautions in Chapter 4.
- Determine the placement of each component in the rack *before* you install the rails.
- Install the heaviest server components on the bottom of the rack first, and then work up.
- Use a regulating uninterruptible power supply (UPS) to protect the server from power surges, voltage spikes and to keep your system operating in case of a power failure.

- Allow the hot plug SAS/SATA drives and power supply modules to cool before touching them.
- Always keep the rack's front door and all panels and components on the servers closed when not servicing to maintain proper cooling.

Rack Mounting Considerations

Ambient Operating Temperature

If installed in a closed or multi-unit rack assembly, the ambient operating temperature of the rack environment may be greater than the ambient temperature of the room. Therefore, consideration should be given to installing the equipment in an environment compatible with the manufacturer's maximum rated ambient temperature (T_{mra}).

Reduced Airflow

Equipment should be mounted into a rack so that the amount of airflow required for safe operation is not compromised.

Mechanical Loading

Equipment should be mounted into a rack so that a hazardous condition does not arise due to uneven mechanical loading.

Circuit Overloading

Consideration should be given to the connection of the equipment to the power supply circuitry and the effect that any possible overloading of circuits might have on overcurrent protection and power supply wiring. Appropriate consideration of equipment nameplate ratings should be used when addressing this concern.

Reliable Ground

A reliable ground must be maintained at all times. To ensure this, the rack itself should be grounded. Particular attention should be given to power supply connections other than the direct connections to the branch circuit (i.e. the use of power strips, etc.).

2-4 Installing the System into a Rack

This section provides information on installing the system into a rack unit. Rack installation requires the use of the optional rackmount kit. If the system has already been mounted into a rack or if you are using it as a tower, you can skip ahead to Sections 2-5 and 2-6.

There are a variety of rack units on the market, which may mean the assembly procedure will differ slightly. The following is a guideline for installing the server into a rack with the rack rails provided in the rackmount kit. You should also refer to the installation instructions that came with the rack unit you are using.

Identifying the Sections of the Rack Rails

The optional rackmount kit includes two rack rail assemblies. Each of these assemblies consist of three sections: an inner fixed chassis rail that secures to the chassis, an outer rack rail that secures directly to the rack itself and two rail brackets, which also attach to the rack (see Figure 2-1.) The inner and outer rails must be detached from each other to install.

To remove the inner chassis rail, pull it out as far as possible - you should hear a "click" sound as a locking tab emerges from inside the rail assembly and locks the inner rail. Depress the locking tab to pull the inner rail completely out. Do this for both assemblies (one for each side).

Figure 2-1. Identifying the Sections of the Rack Rails

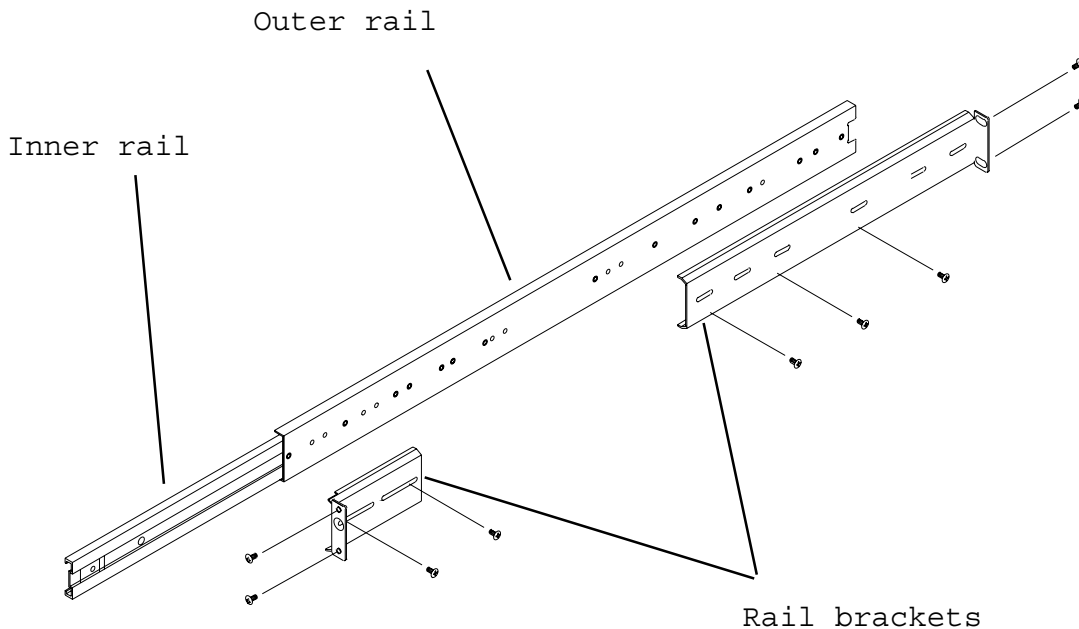

Installing the Chassis Rails

You will need to remove the top cover and the feet to add rack rails to the chassis. First, remove the top and right covers (top and left covers when standing as a tower chassis) by first removing the screws that secure them to the chassis. Depress the button on the top (side if tower) of the chassis to release the cover and then pull the cover off. Then unscrew the four feet and remove them from the chassis (see Figure 2-2).

You can now attach rack rails to the top and bottom (now the sides) of the chassis. First add the rack handles. Then position the inner chassis rail sections you just removed along the side of the chassis making sure the screw holes line up. Note that these two rails are left/right specific. Screw the rail securely to the side of the chassis (see Figure 2-3). Repeat this procedure for the other rail on the other side of the chassis. You will also need to attach the rail brackets when installing into a telco rack.

Locking Tabs: As mentioned, the chassis rails have a locking tab, which serves two functions. The first is to lock the server into place when installed and pushed fully into the rack, which is its normal position. Secondly, these tabs also lock the server in place when fully extended from the rack. This prevents the server from coming completely out of the rack when you pull it out for servicing.

Figure 2-2. Preparing to Install the Chassis Rails

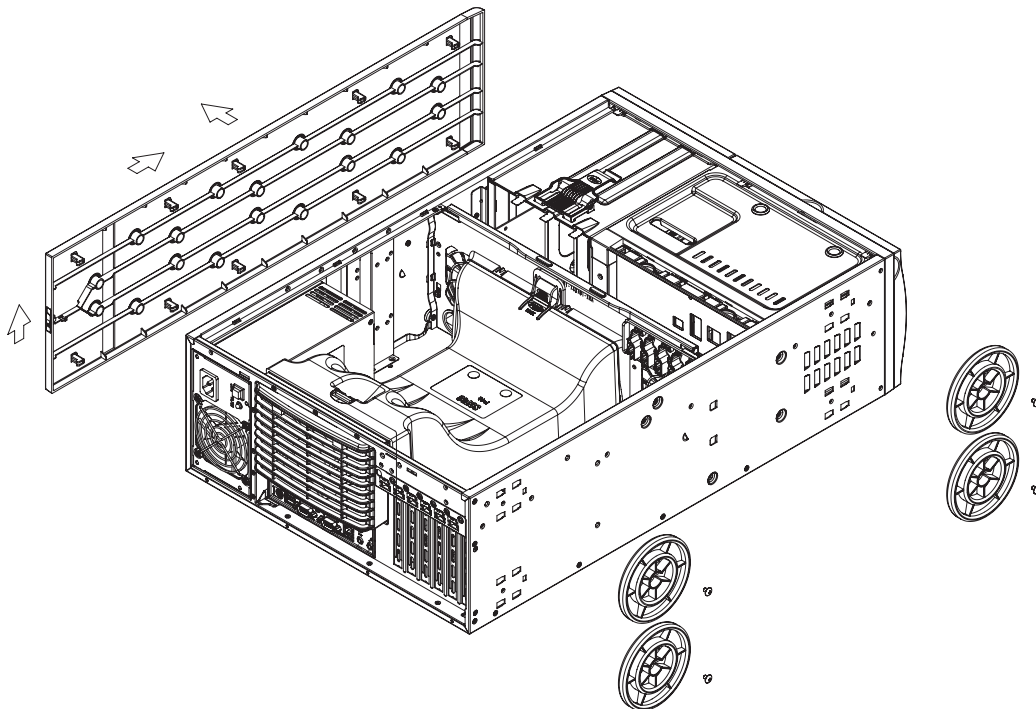
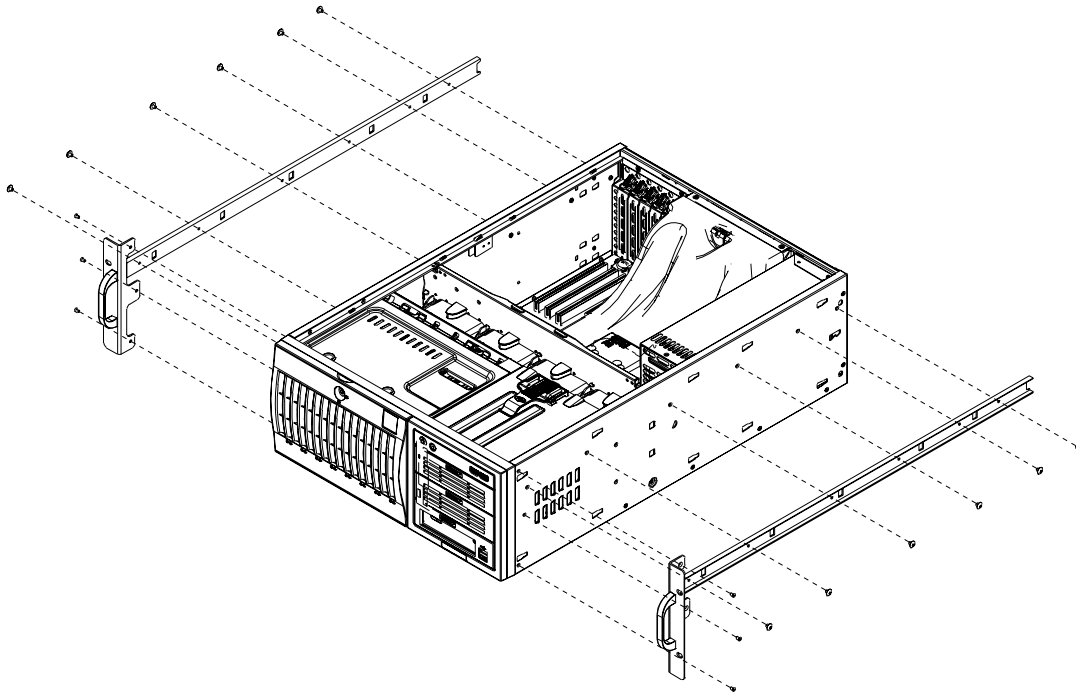

Figure 2-3. Installing the Rails to the Chassis



Installing the Rack Rails

Determine where you want to place the SuperWorkstation 7045A-C3/7045A-CT in the rack. (See Rack and Server Precautions in Section 2-3.) Position the fixed rack rail/sliding rail guide assemblies at the desired location in the rack, keeping the sliding rail guide facing the inside of the rack. Screw the assembly securely to the rack using the brackets provided. Attach the other assembly to the other side of the rack, making sure both are at the exact same height and with the rail guides facing inward.

Installing the Server into the Rack

You should now have rails attached to both the chassis and the rack unit. The next step is to install the server into the rack. You should have two brackets in the rack mount kit. Install these first keeping in mind that they are left/right specific (marked with "L" and "R"). Then, line up the rear of the chassis rails with the front of the rack rails. Slide the chassis rails into the rack rails, keeping the pressure even on both sides (you may have to depress the locking tabs when inserting).

When the server has been pushed completely into the rack, you should hear the locking tabs "click". Finish by inserting and tightening the thumbscrews that hold the front of the server to the rack (see Figure 2-4).

Figure 2-4. Installing the Server into a Rack

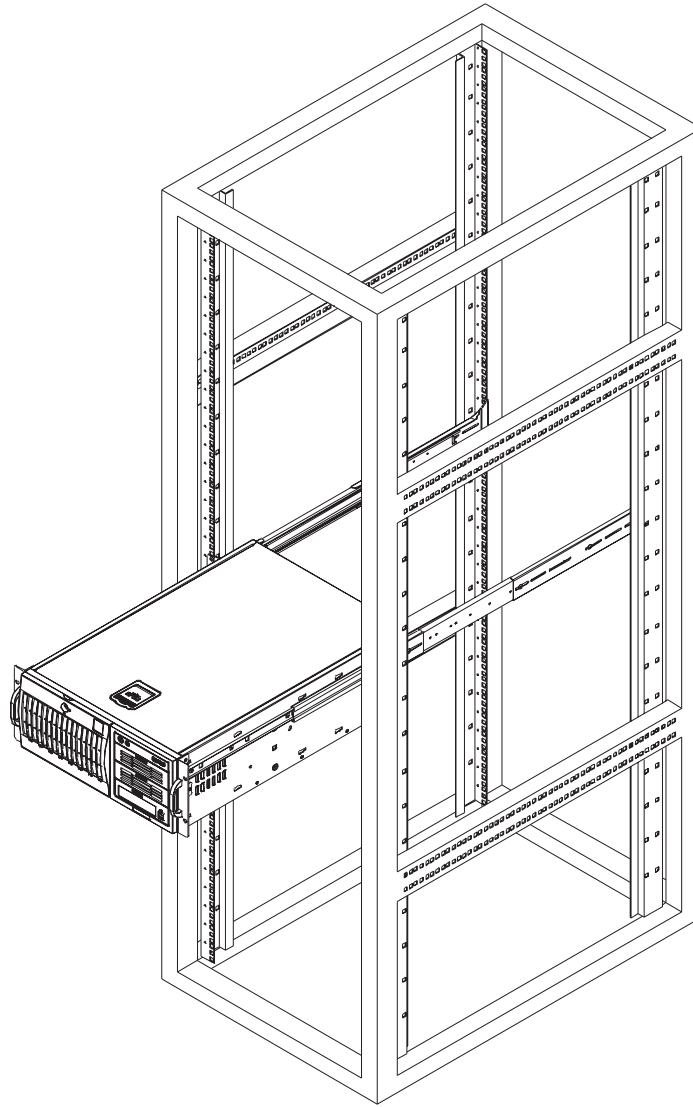

2-5 Checking the Serverboard Setup

After setting up the the system, you will need to open the unit to make sure the serverboard is properly installed and all the connections have been made.

Accessing the Inside of the System

1. If rack mounted, first release the retention screws that secure the unit to the rack. Then grasp the two handles on either side and pull the unit straight out until it locks (you will hear a "click").
2. There are two screws that secure the cover to the chassis - remove these first. Locate the latch on the top (side if tower) of the chassis - depress where it says "push" then lift the latch to release the cover. You can then lift the cover from the chassis to gain full access to the inside of the server. See Figure 2-5.

Checking the Components and Setup

1. You may have one or two processors already installed into the serverboard. Each processor should have its own heatsink attached. See Chapter 5 for instructions on processor installation.
2. Your server may have come with system memory already installed. Make sure all DIMMs are fully seated in their slots. For details on adding system memory, refer to Chapter 5.
3. If desired, you can install add-on cards to the system. See Chapter 5 for details on installing PCI add-on cards.
4. Make sure all power and data cables are properly connected and not blocking the chassis airflow. See Chapter 5 for details on cable connections.

**Figure 2-5. Accessing the Inside of the System
(Rack Configuration shown)**

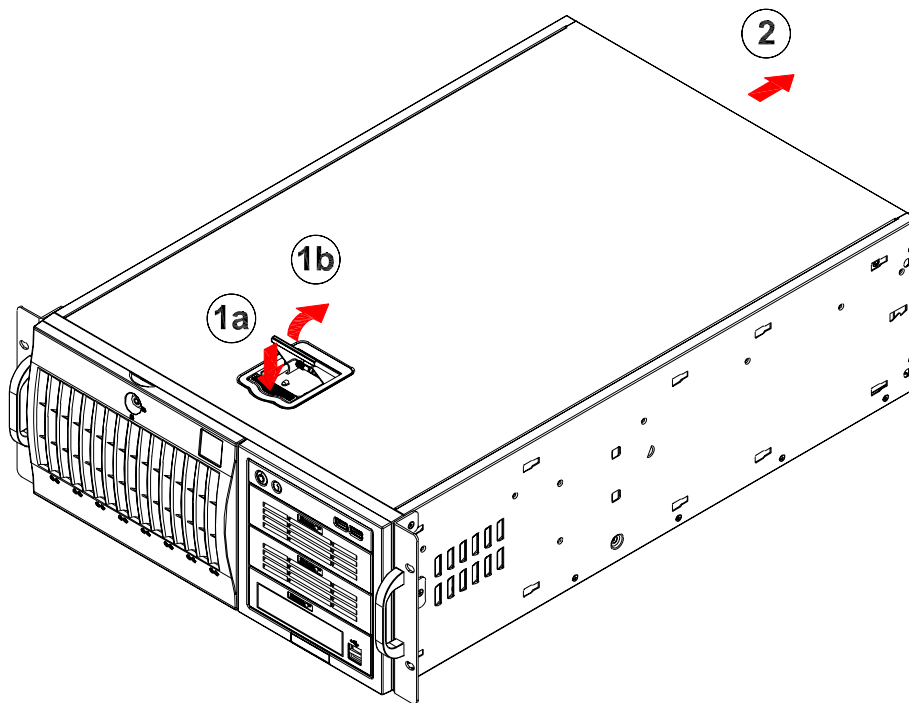

2-6 Checking the Drive Bay Setup

Next, you should check to make sure the peripheral drives and the SAS/SATA drives and backplane have been properly installed and all connections have been made.

Checking the Drives

1. All drives can be accessed from the front of the server. For servicing the CD-ROM, IDE hard drives and floppy drives, you will need to remove the top/left chassis cover. The SAS/SATA disk drives can be installed and removed from the front of the chassis without removing any chassis covers.
2. To install components into the 5.25" drive bays, you must first remove the top/left chassis cover as described in the previous section. Refer to Chapter 6 for details.
3. Refer to Chapter 6 if you need to reinstall a CD-ROM and/or floppy disk drive to the system.

4. Depending upon your system's configuration, your system may have one or more drives already installed. If you need to install SAS/SATA drives, please refer to Chapter 6.

Checking the Airflow

1. Airflow is provided by four hot-swap 8-cm chassis fans working in conjunction with an air shroud. One 9-cm exhaust fan is also mounted at the rear of the chassis. The system component layout was carefully designed to promote sufficient airflow through the chassis.
2. Note that all power and data cables have been routed in such a way that they do not block the airflow generated by the fans. Keep this in mind when you reroute them after working on the system.

Providing Power

1. Plug the power cords from the power supplies unit into a high-quality power strip that offers protection from electrical noise and power surges. It is recommended that you use an uninterruptible power supply (UPS).
2. Depress the power on button on the front of the chassis.

Chapter 3

System Interface

3-1 Overview

The control panel on the 7045A-C3/7045A-CT has several LEDs and two buttons. There are also two LEDs on each SAS/SATA drive carrier. These LEDs keep you constantly informed of the overall status of the system and the activity and health of specific components.

3-2 Control Panel Buttons

There are two push-buttons located on the front of the chassis: a power on/off button and a reset button.



Power

This is the main power button, which is used to apply or turn off the main system power. Turning off system power with this button removes the main power but keeps standby power supplied to the system.

RESET

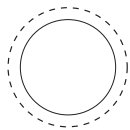

Reset

Use the reset button to reboot the system.

3-3 Control Panel LEDs

The control panel located on the front of the SC743TQ-865-SQ chassis has six LEDs that provide you with critical information related to different parts of the system. This section explains what each LED indicates when illuminated and any corrective action you may need to take.



Power

Indicates power is being supplied to the system's power supply. This LED should normally be on when the system is operating.

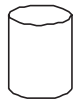

HDD

Indicates IDE channel activity. On the 7045A-C3/7045A-CT, this LED indicates SAS/SATA drive activity when flashing.

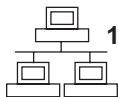

NIC1

Indicates network activity on LAN1 when flashing.

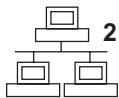

NIC2

Indicates network activity on LAN2 when flashing.

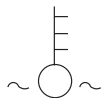

Overheat/Fan Fail

When this LED flashes, it indicates a chassis fan failure. When on continuously it indicates an overheat condition, which may be caused by cables obstructing the

airflow in the system or the ambient room temperature being too warm. Check the routing of the cables and make sure all fans are present and operating normally. You should also check to make sure that the chassis covers are installed. Finally, verify that the heatsinks are installed properly (see Chapter 5). This LED will remain flashing or on as long as the indicated condition exists.



Power Fail

Indicates a power supply fan has failed. The power supply module has a redundant backup fan that will increase its rpm to compensate, but the power module should be replaced as soon as it's convenient.

3-4 Drive Carrier LEDs

Note: the LEDs of some drive carriers may not function depending on the number of drives that are supported by the motherboard and/or backplane.

SAS Drives

- **Green:** When illuminated, the green LED on the front of the SAS drive carrier indicates drive activity. A connection to the SAS backplane enables this LED to blink on and off when that particular drive is being accessed.
- **Red:** The SES2 backplane activates the red LED to indicate a drive failure. If one of the SAS drives fail, you should be notified by your system management software. Please refer to Chapter 6 for instructions on replacing failed SAS drives.

SATA Drives

- **Green:** Each SATA drive carrier has a green LED. When illuminated, this green LED (on the front of the SATA drive carrier) indicates drive activity. A connection to the SATA backplane enables this LED to blink on and off when that particular drive is being accessed. Please refer to Chapter 6 for instructions on replacing failed SATA drives.
- **Red:** The red LED to indicate an SATA drive failure. If one of the SATA drives fail, you should be notified by your system management software. Please refer to Chapter 6 for instructions on replacing failed SATA drives.

Notes

Chapter 4

System Safety

4-1 Electrical Safety Precautions



Basic electrical safety precautions should be followed to protect yourself from harm and the SuperWorkstation 7045A-C3/7045A-CT from damage:

- Be aware of the locations of the power on/off switch on the chassis as well as the room's emergency power-off switch, disconnection switch or electrical outlet. If an electrical accident occurs, you can then quickly remove power from the system.
- Do not work alone when working with high voltage components.
- Power should always be disconnected from the system when removing or installing main system components, such as the serverboard, memory modules and the CD-ROM and floppy drives. When disconnecting power, you should first power down the system with the operating system and then unplug the power cords of all the power supply units in the system.
- When working around exposed electrical circuits, another person who is familiar with the power-off controls should be nearby to switch off the power if necessary.
- Use only one hand when working with powered-on electrical equipment. This is to avoid making a complete circuit, which will cause electrical shock. Use extreme caution when using metal tools, which can easily damage any electrical components or circuit boards they come into contact with.
- Do not use mats designed to decrease electrostatic discharge as protection from electrical shock. Instead, use rubber mats that have been specifically designed as electrical insulators.
- The power supply power cord must include a grounding plug and must be plugged into grounded electrical outlets.

- Serverboard Battery: **CAUTION** - There is a danger of explosion if the onboard battery is installed upside down, which will reverse its polarities (see Figure 4-1). This battery must be replaced only with the same or an equivalent type recommended by the manufacturer. Dispose of used batteries according to the manufacturer's instructions.
- CD-ROM Laser: **CAUTION** - this server may have come equipped with a CD-ROM drive. To prevent direct exposure to the laser beam and hazardous radiation exposure, do not open the enclosure or use the unit in any unconventional way.
- Mainboard replaceable soldered-in fuses: Self-resetting PTC (Positive Temperature Coefficient) fuses on the mainboard must be replaced by trained service technicians only. The new fuse must be the same or equivalent as the one replaced. Contact technical support for details and support.

4-2 General Safety Precautions



Follow these rules to ensure general safety:

- Keep the area around the SuperWorkstation 7045A-C3/7045A-CT clean and free of clutter.
- The 7045A-C3/7045A-CT weighs approximately 64 lbs (29.1 kg.) when fully loaded. When lifting the system, two people at either end should lift slowly with their feet spread out to distribute the weight. Always keep your back straight and lift with your legs. Don't use the handles (if installed) to lift the chassis; the handles should only be used to pull the server out of the rack.
- Place the chassis top cover and any system components that have been removed away from the system or on a table so that they won't accidentally be stepped on.
- While working on the system, do not wear loose clothing such as neckties and unbuttoned shirt sleeves, which can come into contact with electrical circuits or be pulled into a cooling fan.
- Remove any jewelry or metal objects from your body, which are excellent metal conductors that can create short circuits and harm you if they come into contact with printed circuit boards or areas where power is present.

- After accessing the inside of the system, close the system back up and secure it to the rack unit with the retention screws after ensuring that all connections have been made.

4-3 ESD Precautions



Electrostatic discharge (ESD) is generated by two objects with different electrical charges coming into contact with each other. An electrical discharge is created to neutralize this difference, which can damage electronic components and printed circuit boards. The following measures are generally sufficient to neutralize this difference before contact is made to protect your equipment from ESD:

- Use a grounded wrist strap designed to prevent static discharge.
- Keep all components and printed circuit boards (PCBs) in their antistatic bags until ready for use.
- Touch a grounded metal object before removing the board from the antistatic bag.
- Do not let components or PCBs come into contact with your clothing, which may retain a charge even if you are wearing a wrist strap.
- Handle a board by its edges only; do not touch its components, peripheral chips, memory modules or contacts.
- When handling chips or modules, avoid touching their pins.
- Put the serverboard and peripherals back into their antistatic bags when not in use.
- For grounding purposes, make sure your computer chassis provides excellent conductivity between the power supply, the case, the mounting fasteners and the serverboard.

4-4 Operating Precautions



Care must be taken to assure that the chassis cover is in place when the 7045A-C3/7045A-CT is operating to assure proper cooling. Out of warranty damage to the 7045A-C3/7045A-CT system can occur if this practice is not strictly followed.

Figure 4-1. Installing the Onboard Battery

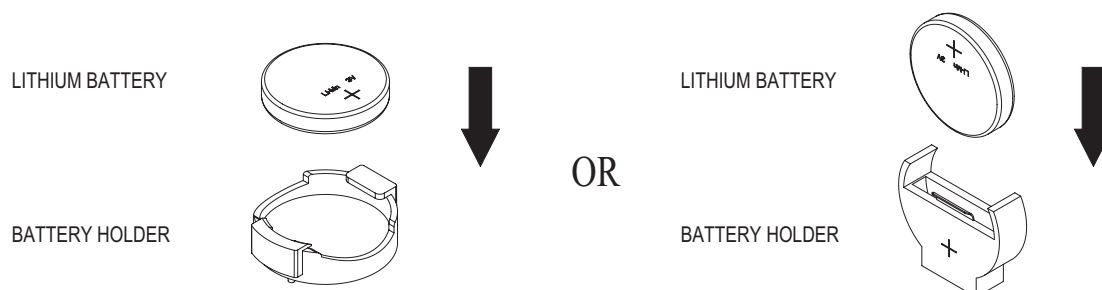

Chapter 5

Advanced Serverboard Setup

This chapter covers the steps required to install the X7DCA-3/X7DCA-i serverboard into the chassis, connect the data and power cables and install add-on cards. All serverboard jumpers and connections are also described. A layout and quick reference chart are included in this chapter for your reference. Remember to completely close the chassis when you have finished working with the serverboard to better cool and protect the system.

5-1 Handling the Serverboard

Electrostatic discharge (ESD) can damage electronic components. To prevent damage to any printed circuit boards (PCBs), it is important to handle them very carefully (see previous chapter). To prevent the serverboard from bending, keep one hand under the center of the board to support it when handling. The following measures are generally sufficient to protect your equipment from electric static discharge.

Precautions

- Use a grounded wrist strap designed to prevent electrostatic discharge (ESD).
- Touch a grounded metal object before removing any board from its antistatic bag.
- Handle a board by its edges only; do not touch its components, peripheral chips, memory modules or gold contacts.
- When handling chips or modules, avoid touching their pins.
- Put the serverboard, add-on cards and peripherals back into their antistatic bags when not in use.
- For grounding purposes, make sure your computer chassis provides excellent conductivity between the power supply, the case, the mounting fasteners and the serverboard.

Unpacking

The serverboard is shipped in antistatic packaging to avoid electrical static discharge. When unpacking the board, make sure the person handling it is static protected.

5-2 Serverboard Installation

This section explains the first step of physically mounting the X7DCA-3/X7DCA-i into the SC743TQ-865-SQ chassis. Following the steps in the order given will eliminate the most common problems encountered in such an installation. To remove the serverboard, follow the procedure in reverse order.

Installing to the Chassis

1. Access the inside of the system by removing the screws from the back lip of the side cover of the chassis, then pull the cover off.
2. The X7DCA-3/X7DCA-i requires a chassis big enough to support a 12" x 13" serverboard, such as Supermicro's SC743TQ-865-SQ.
3. Make sure that the I/O ports on the serverboard align properly with their respective holes in the I/O shield at the back of the chassis.
4. Carefully mount the serverboard to the serverboard tray by aligning the board holes with the raised metal standoffs that are visible in the chassis.
5. Insert screws into all the mounting holes on your serverboard that line up with the standoffs and tighten until snug (if you screw them in too tight, you might strip the threads). Metal screws provide an electrical contact to the serverboard ground to provide a continuous ground for the system.
6. Finish by replacing the chassis cover.

5-3 Connecting Cables

Now that the serverboard is installed, the next step is to connect the cables to the board. These include the data cables for the peripherals and control panel and the power cables.

Connecting Data Cables

The cables used to transfer data from the peripheral devices have been carefully routed to prevent them from blocking the flow of cooling air that moves through the system from front to back. If you need to disconnect any of these cables, you should take care to keep them routed as they were originally after reconnecting them (make sure the red wires connect to the pin 1 locations). The following data cables (with their locations noted) should be connected. (See the layout on page 5-12 for connector locations.)

- Control Panel cable (JF1)
- Floppy drive cable (Floppy)

7045A-3

- SAS drive data cables (SAS0 ~ SAS7)

7045A-T

- SATA drive data cables (I-SATA0 ~ I-SATA5)
- SGPIO cable (T-SGPIO-1, T-SGPIO-2)

Important! Make sure the the cables do not come into contact with the fans.

Connecting Power Cables

The X7DCA-3/X7DCA-i has a 24-pin primary power supply connector (JPW3) for connection to the ATX power supply. In addition, there is a 4-pin secondary power connector (JPW1) as well as an 8-pin processor power connector (JPW2) that must be connected to your power supply. See Section 5-9 for power connector pin definitions.

Connecting the Control Panel

JF1 contains header pins for various front control panel connectors. See Figure 5-1 for the pin locations of the various front control panel buttons and LED indicators.

All JF1 wires have been bundled into a single cable to simplify this connection. Make sure the red wire plugs into pin 1 as marked on the board. The other end connects to the Control Panel PCB board, located just behind the system status LEDs on the chassis. See Chapter 5 for details and pin descriptions.

Figure 5-1. Control Panel Header Pins

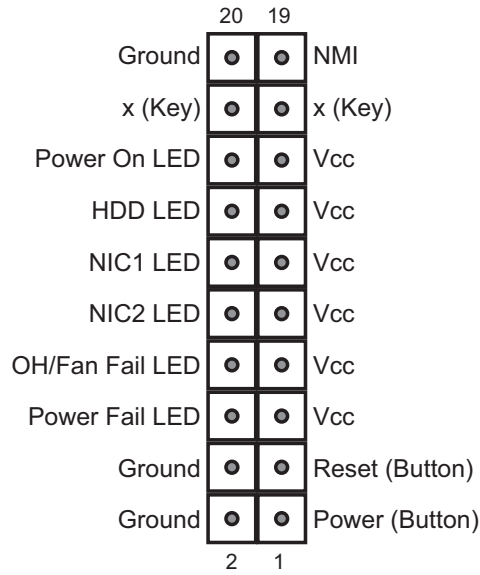

5-4 I/O Ports

The I/O ports are color coded in conformance with the PC 99 specification. See Figure 5-2 below for the colors and locations of the various I/O ports.

Figure 5-2. I/O Ports

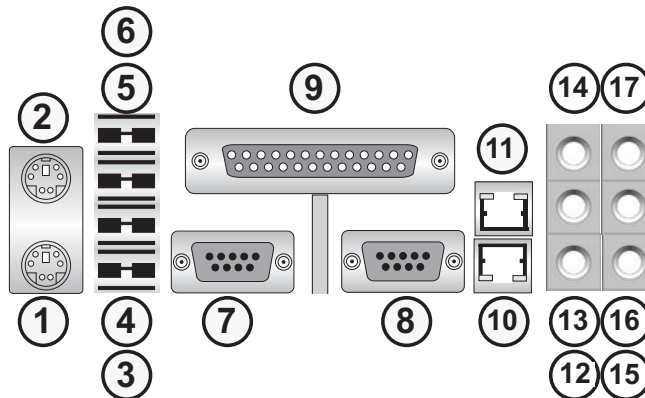

I/O Port Definitions			
1	PS/2 Keyboard	10	LAN1 Port
2	PS/2 Mouse	11	LAN2 Port
3	USB Port 0	12	Side Speaker (Gray)
4	USB Port 1	13	Rear Speaker (Black)
5	USB Port 2	14	Center/Subwoofer (Orange)
6	USB Port 3	15	Mic In (Pink)
7	COM1 Port	16	Front Speaker (Lime)
8	COM2 Port	17	Line In (Light Blue)
9	Parallel (Printer) Port		

5-5 Installing the Processor and Heat Sink



Avoid placing direct pressure to the top of the processor package. Always remove the power cord first before adding, removing or changing any hardware components.

Notes: Always connect the power cord last and remove it before adding, removing or changing any components. Make sure to install the processor into the CPU socket before you install the CPU heat sink.

Intel's boxed Xeon CPU package contains the CPU fan and heat sink assembly. If you buy the CPUs separately, use only Intel-certified heat sinks and fans.

Make sure to install the heat sink backplate and the serverboard into the chassis before you install the CPU heat sink and fan (see below).

Inspect the CPU socket and make sure that the CPU plastic cap is in place and none of the socket pins are bent. Otherwise, contact the retailer immediately.

All graphics shown in this manual are for reference only. The components that came with your serverboard may or may not look exactly the same as the pictures shown in this manual.

Installation Procedure

For proper system setup, please follow the procedures in the order given below:

1. Install the heat sink backplate into the chassis if needed
2. Install the serverboard into the chassis.
3. Install the CPU(s).
4. Install the heat sink or/and cooling fans (if any).
5. Connect fan and power cables.

CPU Installation

1. A black PnP cap is attached to the load plate to protect the CPU socket. Press the load lever down and away from the retention clasp to release the load plate from its locked position.

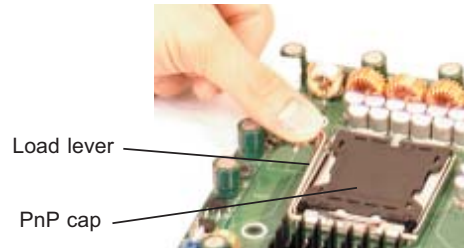

2. Gently lift the load lever to open the load plate.
3. Use your thumb and your index finger to hold the CPU at opposite sides.
4. Align pin1 of the CPU (the corner marked with a triangle) with the notched corner of the CPU socket.



5. Find the corner of the CPU that has a semi-circle cutout below a gold dot (CPU key). This corner should be aligned with the cutout on the socket (socket key).

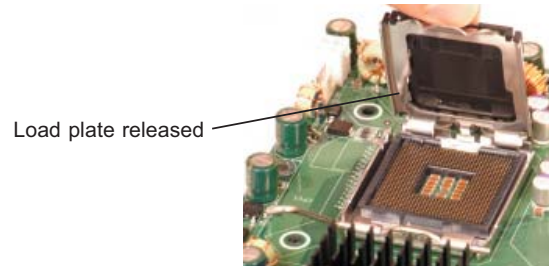

6. Once aligned, carefully lower the CPU straight down into the socket. Do not drop the CPU on the socket, do not move the CPU horizontally or vertically and do not rub the CPU against any surface or any of the contacts, which may damage the CPU and/or contacts.



7. With the CPU in the socket, inspect the four corners of the CPU to make sure that it is properly installed.
8. Use your thumb to gently push the load lever down until it snaps into the retention clasp.
9. If the CPU is properly installed into the socket, the PnP cap will be automatically released from the load plate when the lever locks. Remove the cap. Repeat steps to install a second CPU if desired.

Warning! Keep the plastic PnP cap. The serverboard must be shipped with the PnP cap properly installed to protect the CPU socket. Shipment without the PnP cap properly installed will void the warranty.

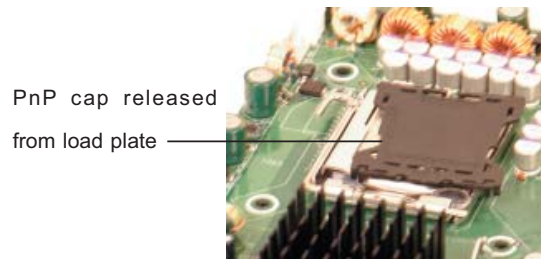
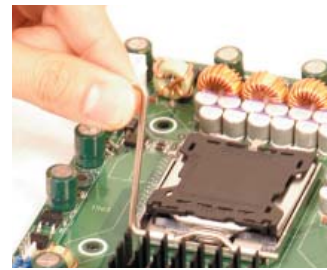
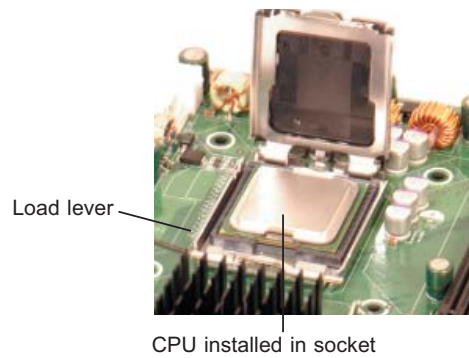
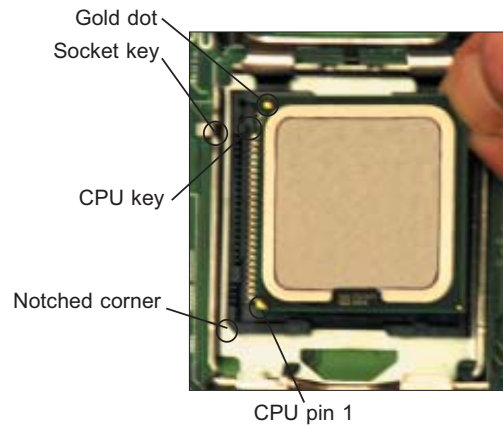

Installation and Removal of the Heat Sink

Installing the Heat Sink Installation

1. Do not apply any thermal grease to the heat sink or the CPU die; the required amount has already been applied.
2. Place the heatsink on top of the CPU so that the four mounting holes are aligned with those on the retention mechanism.
3. Screw in two diagonal screws (i.e. the #1 and the #2 screws) until just snug (do not over-tighten the screws, which may damage the CPU.)
4. Finish the installation by fully tightening all four screws.

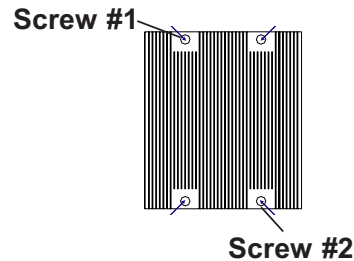

Uninstalling the Heat Sink



Warning: We do not recommend removing the CPU or the heat sink. However, if you do need to uninstall the heat sink, please follow these instructions to avoid damaging the CPU or the CPU socket.

1. Unscrew and remove the heat sink screws in the sequence shown in the picture on the right.
2. Hold the heat sink as shown in the picture on the right and gently wriggle to loosen it from the CPU. (Do not use excessive force when doing this!)
3. Once the heat sink is loosened, remove it from the CPU socket.
4. Clean the surface of the CPU and the heat sink to get rid of the old thermal grease. Reapply the proper amount of thermal grease before you re-install the heat sink.

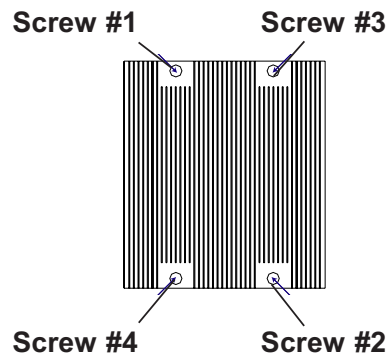

5-6 Installing Memory



CAUTION! Exercise extreme care when installing or removing DIMM modules to prevent any possible damage.

Installing Memory Modules

1. Insert the desired number of DIMMs into the memory slots. The memory scheme is interleaved, so you must install two modules at a time, beginning with DIMM 1A and DIMM 1B, then DIMM 2A and DIMM 2B and finally DIMM 3A and DIMM 3B.
2. Insert each DIMM module vertically into its slot. Pay attention to the notch along the bottom of the module to prevent inserting the DIMM module incorrectly.
3. Gently press down on the DIMM module until it snaps into place in the slot. Repeat for all modules (see step 1 above).

Memory Support

The X7DCA-3/X7DCA-i supports up to 32 GB of registered ECC DDR2-667/533 in 6 slots. Populating slots with a pair (or pairs) of DIMMs of the same type and size will result in interleaved memory.

Notes: Due to OS limitations, some operating systems may not show more than 4 GB of memory.

Due to memory allocation to system devices, memory remaining available for operational use will be reduced when 4 GB of RAM is used. The reduction in memory availability is disproportional. Refer to the table below for details.

Possible System Memory Allocation & Availability		
System Device	Size	Physical Memory Remaining (-Available) (4 GB Total System Memory)
Firmware Hub flash memory (System BIOS)	1 MB	3.99
Local APIC	4 KB	3.99
Area Reserved for the chipset	2 MB	3.99
I/O APIC (4 Kbytes)	4 KB	3.99
PCI Enumeration Area 1	256 MB	3.76
PCI Express (256 MB)	256 MB	3.51
PCI Enumeration Area 2 (if needed) -Aligned on 256-MB boundary-	512 MB	3.01
VGA Memory	16 MB	2.85
TSEG	1 MB	2.84
Memory available to OS and other applications		2.84

Figure 5-3. DIMM Installation

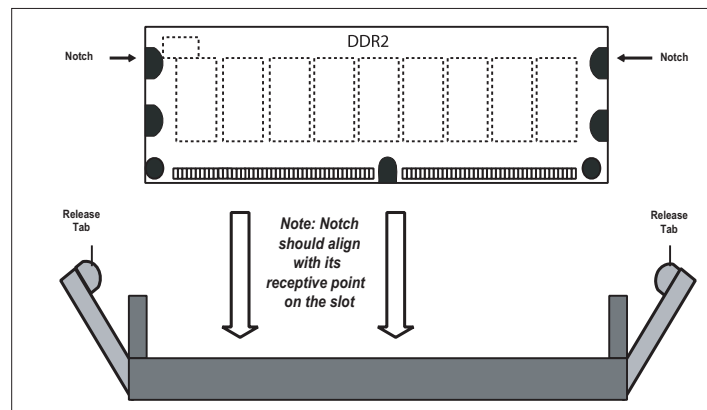

Top View of DDR2 Slot

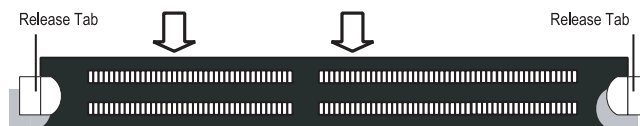

To Install: Insert module vertically and press down until it snaps into place. Pay attention to the bottom notches.

To Remove: Use your thumbs to gently push each release tab outward to free the DIMM from the slot.

5-7 Adding PCI Cards

The X7DCA-3/X7DCA-i has one PCI-Express x16 slot, one PCI-Express x4 slot (in a x16 slot), two 64-bit 133/100 MHz PCI-X slots and two PCI 33 MHz slots. The SC743TQ-865-SQ chassis can accommodate up to seven PCI expansion cards. PCI cards are installed directly to the serverboard.

Installing an Add-on Card

Before installing a PCI add-on card, make sure you install it into a slot that supports the speed of the card (see step 1, above).

1. Begin by removing the PCI slot shield for the slot you wish to populate.
2. Fully seat the card into the riser card slot, pushing down with your thumbs evenly on both sides of the card.
3. Finish by using a screw to secure the top of the card shield to the chassis. The PCI slot shields protect the serverboard and its components from EMI and aid in proper ventilation, so make sure there is always a shield covering each unused slot.

5-8 Serverboard Details

Figure 5-4. X7DCA-3/X7DCA-i Layout
(not drawn to scale)

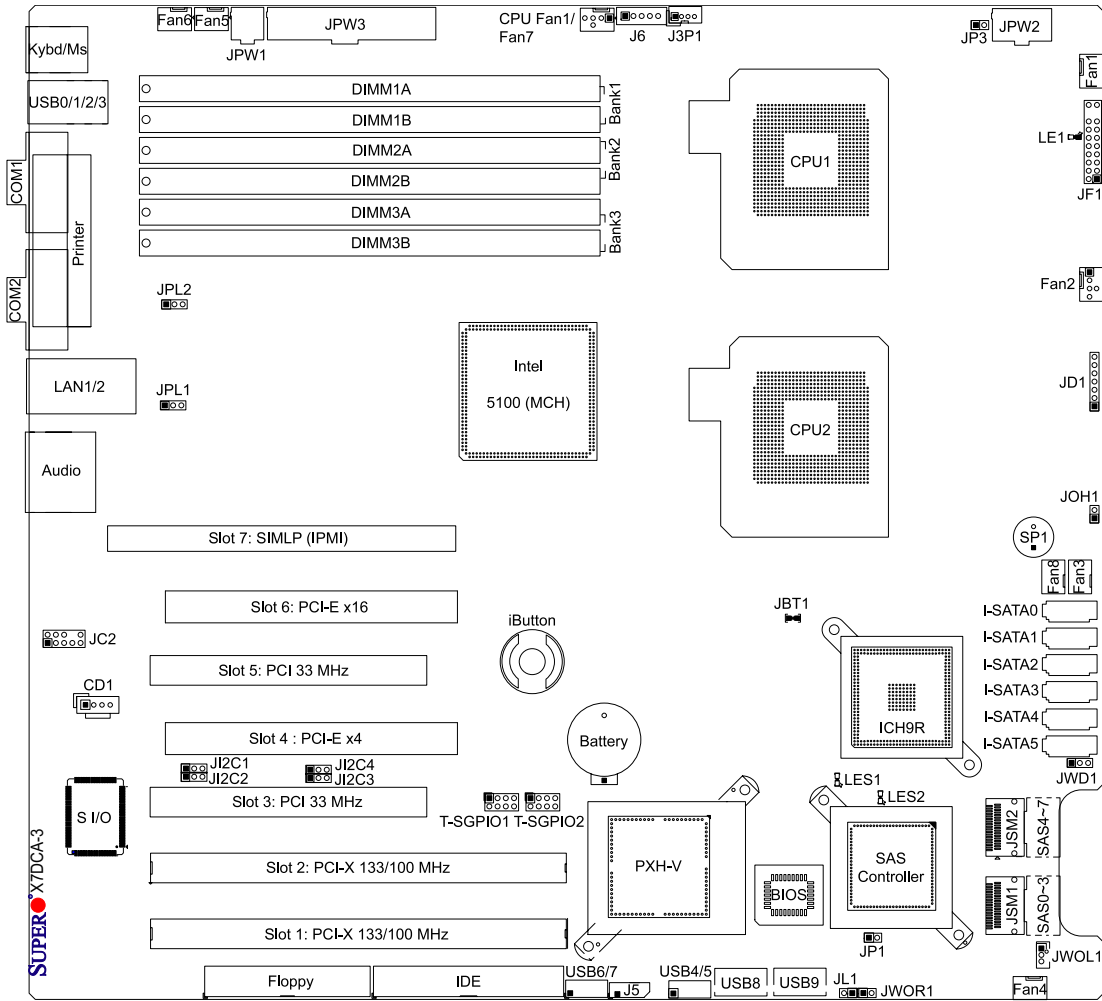

Note: the X7DCA-i shares the same layout as the X7DCA-3 but has no SAS components or connectors.

X7DCA-3/X7DCA-i Quick Reference

Jumper	Description	Default Setting
JBT1	CMOS Clear	(See Section 5-10)
J ² C1/JI ² C2	I ² C to PCI-X Slots	Pins 2-3 (Disabled)
J ² C3/JI ² C4	I ² C to PCI-E Slots	Pins 2-3 (Disabled)
JPL1/JPL2	LAN1/2 Enable/Disable	Pins 1-2 (Enabled)
JWD1	Watch Dog	Pins 1-2 (Reset)

Connector	Description
Audio	High Definition Audio (HDA) Jacks
CD1/JC2	Audio Headers (see Section 5-9)
COM1/COM2	COM1 Serial Ports
FAN 1-8	Chassis/CPU Fan Headers
Floppy	Floppy Disk Drive Connector
IDE	IDE Drive Connector
I-SATA0 ~ I-SATA5	SATA Ports
J5	Power System Management (I ² C) Header
J6	Power Supply SMBus I ² C Header
JD1	Onboard Speaker/Power LED
JF1	Control Panel Connector
JL1	Chassis Intrusion Header
JOH1	Overheat Warning Header
JP3	SAS Power System Management I ² C Header
JPW1	4-Pin Power Connector
JPW2	8-Pin Power Connector
JPW3	24-pin Main ATX Power Connector
JWOL1	Wake-On-LAN Header
JWOR1	Wake-On-Ring Header
LAN1/2	Gigabit Ethernet (RJ45) Ports
SAS0~3, SAS4~7*	Serial Attached SCSI (SAS) Ports
SIMLP	IPMI (Remote Management) Slot
T-SGPIO-1/T-SGPIO-2	Serial General Purpose Input/Output Headers
USB0/1/2/3, USB8, USB9	Universal Serial Bus (USB) Ports
USB4/5, USB6/7	Universal Serial Bus (USB) Headers

*X7DCA-3 only.

5-9 Connector Definitions

Main ATX Power Supply Connector

The primary power supply connector (JPW3) meets the SSI (Superset ATX) 24-pin specification. Refer to the table on the right for the pin definitions of the ATX 24-pin power connector. You must also connect the 4-pin (JPW1) and 8-pin (JPW2) power connectors to your power supply (see below).

ATX Power 24-pin Connector Pin Definitions (JPW3)			
Pin#	Definition	Pin #	Definition
13	+3.3V	1	+3.3V
14	-12V	2	+3.3V
15	COM	3	COM
16	PS_ON	4	+5V
17	COM	5	COM
18	COM	6	+5V
19	COM	7	COM
20	Res (NC)	8	PWR_OK
21	+5V	9	5VSB
22	+5V	10	+12V
23	+5V	11	+12V
24	COM	12	+3.3V

Secondary Power Connectors

JPW1 must also be connected to the power supply. See the table on the right for pin definitions.

+12V 4-pin Power Pin Definitions (JPW1)	
Pins	Definition
1 - 2	Ground
3 - 4	+12V

Required Connection

Processor Power Connector

In addition to the Main ATX power connector (above), the 12V 8-pin processor power connector at JPW2 must also be connected to your power supply. See the table on the right for pin definitions.

+12V 8-pin Power Pin Definitions (JPW2)	
Pins	Definition
1 - 4	Ground
5 - 8	+12V

Required Connection

PW_ON Connector

The PW_ON connector is on pins 1 and 2 of JF1. This header should be connected to the chassis power button. See the table on the right for pin definitions.

Power Button Pin Definitions (JF1)	
Pin#	Definition
1	PW_ON
2	Ground

Reset Connector

The reset connector is located on pins 3 and 4 of JF1 and attaches to the reset switch on the computer chassis. See the table on the right for pin definitions.

Reset Button Pin Definitions (JF1)	
Pin#	Definition
3	Reset
4	Ground

Power Fail LED

The Power Fail LED connection is located on pins 5 and 6 of JF1. Refer to the table on the right for pin definitions.

PWR Fail LED Pin Definitions (JF1)	
Pin#	Definition
5	Vcc
6	Ground

Overheat/Fan Fail LED (OH)

Connect an LED to the OH connection on pins 7 and 8 of JF1 to provide advanced warning of chassis overheating. Refer to the table on the right for pin definitions.

OH/Fan Fail LED Pin Definitions (JF1)		OH/Fan Fail Indicator Status	
Pin#	Definition	State	Definition
7	Vcc	Off	Normal
8	Ground	On	Overheat
		Flash- ing	Fan Fail

NIC2 (LAN2) LED

The LED connections for LAN2 are on pins 9 and 10 of JF1. Attach an LED cable to display network activity. See the table on the right for pin definitions.

NIC2 LED Pin Definitions (JF1)	
Pin#	Definition
9	Vcc
10	Ground

NIC1 (LAN1) LED

The LED connections for LAN1 are on pins 11 and 12 of JF1. Attach an LED cable to display network activity. See the table on the right for pin definitions.

NIC1 LED Pin Definitions (JF1)	
Pin#	Definition
11	Vcc
12	Ground

HDD LED

The HDD LED connection is located on pins 13 and 14 of JF1. This LED is used to display all IDE and SATA activity. See the table on the right for pin definitions.

HDD LED Pin Definitions (JF1)	
Pin#	Definition
13	Vcc
14	HD Active

Power On LED

The Power On LED connector is located on pins 15 and 16 of JF1 (use JLED for a 3-pin connector). This connection is used to provide LED indication of power being supplied to the system. See the table on the right for pin definitions.

Power LED Pin Definitions (JF1)	
Pin#	Definition
15	5V Stby
16	Control

NMI Button

The non-maskable interrupt button header is located on pins 19 and 20 of JF1. Refer to the table on the right for pin definitions.

NMI Button Pin Definitions (JF1)	
Pin#	Definition
19	Control
20	Ground

Fan Headers

There are eight fan headers on the serverboard, all of which are 4-pin fans. (Pins 1-3 of the fan headers are backward compatible with the traditional 3-pin fans.) See the table on the right for pin definitions. The onboard fan speeds are controlled by Thermal Management (via Hardware Monitoring) under the Advanced Section in the BIOS. The default is disabled. When using Thermal Management setting, please use all 3-pin fans or all 4-pin fans.

Fan Header Pin Definitions (FAN1-8)	
Pin#	Definition
1	Ground (Black)
2	+12V (Red)
3	Tachometer
4	PWM Control

Note: Fan 7 is for the CPU1 and Fan8 is for the CPU2 heat sink.

Chassis Intrusion

The Chassis Intrusion header is designated JL1. Attach an appropriate cable from the chassis to inform you of a chassis intrusion when the chassis is opened

Chassis Intrusion Pin Definitions (JL1)	
Pin#	Definition
1	Intrusion Input
2	Ground

Wake-On-LAN

The Wake-On-LAN header is designated JWOL1 on the serverboard. See the table on the right for pin definitions. You must also have a LAN card with a Wake-On-LAN connector and cable to use this feature.

Wake-On-LAN Pin Definitions (JWOL1)	
Pin#	Definition
1	+5V Standby
2	Ground
3	Wake-up

Wake-On-Ring

The Wake-On-Ring header is designated JWOR1. This function allows your computer to receive and be "awakened" by an incoming call when in the suspend state. See the table on the right for pin definitions. You must also have a WOR card and cable to use this feature.

Wake-On-Ring Pin Definitions (JWOR1)	
Pin#	Definition
1	Ground (Black)
2	Wake-up

LAN1/2 (Ethernet Ports)

Two Ethernet ports (designated LAN1 and LAN2) are located beside the VGA port on the I/O backplane. These ports accept RJ45 type cables.



Serial Ports

Two serial ports (COM1 and COM2) are included on the I/O backplane. See the table on the right for pin definitions.

Serial Port Pin Definitions (COM1/COM2)			
Pin #	Definition	Pin #	Definition
1	DCD	6	DSR
2	RXD	7	RTS
3	TXD	8	CTS
4	DTR	9	RI
5	Ground	10	NC

Overheat LED/Fan Fail (JOH1)

The JOH1 header is used to connect an LED to provide warning of chassis overheating. This LED will blink to indicate a fan failure. Refer to the table on right for pin definitions.

OH/Fan Fail LED States		Overheat LED Pin Definitions (JOH1)	
State	Message	Pin#	Definition
Solid	Overheat	1	5vDC
Blinking	Fan Fail	2	OH Active

Power LED/Speaker

On JD1 header, pins 1-3 are for a power LED and pins 4-7 are for the speaker. Close pins 4-7 with a jumper to use an external speaker. If you wish to use the onboard speaker, please close pins 6-7. See the table on the right for speaker pin definitions.

Power LED/Speaker Connector (JD1)	
Pin Setting	Definition
Pins 6-7	Internal Speaker
Pins 4-7	External Speaker

Universal Serial Bus (USB)

There are two Universal Serial Bus ports located on the I/O panel (USB0/1/2/3), four USB headers located on the serverboard (USB4/5 and USB6/7) and two additional ports located on the board itself (USB8 and USB9). The headers can be used to provide front side USB access (cables not included). See the table on the right for pin definitions.

Universal Serial Bus Pin Definitions (USB)			
USB0/1/2/3/8/9		USB4/5, USB6/7	
Pin #	Definition	Pin #	Definition
1	+5V	1	+5V
2	PO-	2	PO-
3	PO+	3	PO+
4	Ground	4	Ground
5	N/A	5	Key

SGPIO Headers

The SGPIO (Serial General Purpose Input/Output) headers are used to communicate with a system-monitoring chip on the backplane. See the table on the right for pin definitions.

SGPIO Header Pin Definitions (T-SGPIO-1/T-SGPIO-2)			
Pin#	Definition	Pin	Definition
1	NC	2	NC
3	Ground	4	DATA Out
5	Load	6	Ground
7	Clock	8	NC

NC = No Connection

ATX PS/2 Keyboard and PS/2 Mouse Ports

The ATX PS/2 keyboard and the PS/2 mouse are located beside the USB0/1 ports. The mouse port is above the keyboard port. See the table on the right for pin definitions.

PS/2 Keyboard and Mouse Port Pin Definitions	
Pin#	Definition
1	Data
2	NC
3	Ground
4	VCC
5	Clock
6	NC

Power SMB (I²C) Connector

The power SMB (I²C) connector is used to monitor the status of the power supply, fan and system temperature. See the table on the right for pin definitions.

PWR SMB Header Pin Definitions (J6)	
Pin#	Definition
1	Clock
2	Data
3	PWR Fail (Input from PS to MB)
4	Ground
5	+3.3V

Backpanel Power SMB (I²C) Connector

The power SMB (I²C) connector is used to monitor the status of the power supply and the temperature of the backplane. See the table on the right for pin definitions.

Backpanel PWR SMB Connector Pin Definitions (J5)	
Pin#	Definition
1	SMBDAT_ICH_EXIT
2	Ground
3	SMBCLK_ICH_EXIT
4	NC

SAS Power SMB (I²C) Connector

The SAS power SMB (I²C) connector is used to monitor the status of the power supply system management bus for the SAS ports. See the table on the right for pin definitions (X7DCA-i only).

SAS PWR SMB Connector Pin Definitions (JP3)	
Pin#	Definition
1	TWSI_SDA
2	Ground
3	TWSI_SCK

CD Header

A 4-pin CD header (CD1) and a Front Panel Audio header (JC2) are included on the serverboard. These headers allow you to use the on-board sound for audio CD playback. Connect an audio cable from your CD drive to the CD header that fits your cable's connector. Only one CD header can be used at any time.

CD Header Pin Definitions (CD1)	
Pin#	Definition
1	Left
2	Ground
3	Ground
4	Right

Front Panel Audio Control

When front panel headphones are plugged in, the back panel audio output is disabled. This is done through the FP Audio header (JC2). If the front panel interface card is not connected to the front panel audio header, jumpers should be installed on pin pairs 1-2, 5-6, and 9-10 of the Audio FP header. If these jumpers are not installed, the back panel line out connector will be disabled, and pin 1 of the microphone in will be left floating, which can lead to excessive back panel microphone noise and crosstalk. See the table at right for pin definitions.

Front Panel Audio Pin Definitions (JC2)	
Pin#	Definition
1	MIC_L
2	Audio Ground
3	MIC_R
4	FP Audio Detect
5	Line_2_R
6	Ground
7	FP_Jack Detect
8	Key
9	Line_2_L
10	Ground

5-10 Jumper Settings

Explanation of Jumpers

To modify the operation of the serverboard, jumpers can be used to choose between optional settings. Jumpers create shorts between two pins to change the function of the connector. Pin 1 is identified with a square solder pad on the printed circuit board. See the serverboard layout pages for jumper locations.

Note: On a two-pin jumper, "Closed" means the jumper is on both pins and "Open" means the jumper is either on only one pin or completely removed.

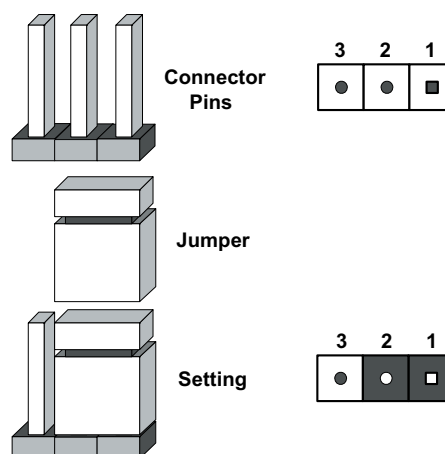

CMOS Clear

JBT1 is used to clear CMOS (which will also clear any passwords). Instead of pins, this jumper consists of contact pads to prevent accidentally clearing the contents of CMOS.

To clear CMOS,

1. First power down the system and unplug the power cord(s).
2. With the power disconnected, short the CMOS pads with a metal object such as a small screwdriver.
3. Remove the screwdriver (or shorting device).
4. Reconnect the power cord(s) and power on the system.

Note: Do not use the PW ON connector to clear CMOS.

LAN1/2 Enable/Disable

Change the setting of jumper JPL1 and JPL2 to enable or disable the LAN1 and LAN2 Ethernet ports, respectively. See the table on the right for jumper settings. The default setting is enabled.

LAN1/2 Enable/Disable Jumper Settings (JPL1)	
Jumper Setting	Definition
Pins 1-2	Enabled
Pins 2-3	Disabled

I²C Bus to PCI-X/ Slots

Jumpers JI²C1 and JI²C2 allow you to connect the System Management Bus (I²C) to the PCI-X slots. The default setting is Disabled. Both jumpers must be set to the same setting. See the table on the right for jumper settings.

I ² C to PCI-X Slots Jumper Settings (JI ² C1/JI ² C2)	
Jumper Setting	Definition
Pins 1-2	Enabled
Pins 2-3	Disabled

I²C Bus to PCI-Exp. Slots

Jumpers JI²C3 and JI²C4 allow you to connect the System Management Bus (I²C) to the PCI-E slots. The default setting is Disabled. Both jumpers must be set to the same setting. See the table on the right for jumper settings.

I ² C to PCI-E Slots Jumper Settings (JI ² C3/JI ² C4)	
Jumper Setting	Definition
Pins 1-2	Enabled
Pins 2-3	Disabled

Watch Dog Enable/Disable

JWD controls the Watch Dog function. Watch Dog is a system monitor that can reboot the system when a software application hangs. Jumping pins 1-2 will cause WD to reset the system if an application hangs. Jumping pins 2-3 will generate a non-maskable interrupt signal for the application that hangs. See the table on the right for jumper settings. Watch Dog must also be enabled in BIOS.

Watch Dog Jumper Settings (JWD)	
Jumper Setting	Definition
Pins 1-2	Reset
Pins 2-3	NMI
Open	Disabled

Note: When enabled, the user needs to write their own application software in order to disable the Watch Dog Timer.

5-11 Onboard Indicators

LAN1/2 LEDs

The Ethernet ports (located beside the VGA port) have two LEDs. On each port, one LED indicates activity while the other LED may be green, amber or off to indicate the speed of the connection. See the table on the right for the functions associated with the connection speed LED.

LAN1/2 LED (Connection Speed Indicator)	
LED Color	Definition
Off	10 MHz
Green	100 MHz
Amber	1 GHz

Onboard Power LED (LE1)

An Onboard Power LED is located at LE1. This LED Indicator is lit when the system is on. Be sure to unplug the power cable before removing or adding any components. See the table on the right for more details.

Onboard PWR LED Indicator (LE1)	
LED Color	Definition
Off	System Off
Blinking	Standby
On	System On

SAS LEDs

Two SAS LEDs are designated LES1 and LES2. When illuminated, these LEDs indicate activity on the SAS ports.

5-12 Parallel, Floppy, IDE, and SATA Ports

Use the following information to connect the IDE hard disk drive cables.

- A red mark on a wire typically designates the location of pin 1.
- The 80-wire ATA100/66 IDE hard disk drive cable that came with your system has two connectors to support two drives. This special cable should be used to take advantage of the speed this new technology offers. The blue connector connects to the onboard IDE connector interface and the other connector(s) to your hard drive(s). Consult the documentation that came with your disk drive for details on actual jumper locations and settings for the hard disk drive.

Parallel (Printer) Port

The parallel (printer) port is located above the COM ports. See the table on the right for pin definitions.

Parallel (Printer) Port Pin Definitions			
Pin#	Definition	Pin #	Definition
1	Strobe-	2	Auto Feed-
3	Data Bit 0	4	Error-
5	Data Bit 1	6	Init-
7	Data Bit 2	8	SLCT IN-
9	Data Bit 3	10	GND
11	Data Bit 4	12	GND
13	Data Bit 5	14	GND
15	Data Bit 6	16	GND
17	Data Bit 7	18	GND
19	ACK	20	GND
21	BUSY	22	Write Data
23	PE	24	Write Gate
25	SLCT	26	NC

IDE Connector

There is a single IDE connector on the serverboard. See the table on the right for pin definitions.

IDE Drive Connector Pin Definitions (IDE)			
Pin#	Definition	Pin #	Definition
1	Reset IDE	2	Ground
3	Host Data 7	4	Host Data 8
5	Host Data 6	6	Host Data 9
7	Host Data 5	8	Host Data 10
9	Host Data 4	10	Host Data 11
11	Host Data 3	12	Host Data 12
13	Host Data 2	14	Host Data 13
15	Host Data 1	16	Host Data 14
17	Host Data 0	18	Host Data 15
19	Ground	20	Key
21	DRQ3	22	Ground
23	I/O Write	24	Ground
25	I/O Read	26	Ground
27	IOCHRDY	28	BALE
29	DACK3	30	Ground
31	IRQ14	32	IOCS16
33	Addr1	34	Ground
35	Addr0	36	Addr2
37	Chip Select 0	38	Chip Select 1
39	Activity	40	Ground

SATA Ports

There are no jumpers to configure the onboard SATA connectors. See the table on the right for pin definitions.

SATA Port Pin Definitions (I-SATA0~I-SATA5)	
Pin #	Definition
1	Ground
2	TXP
3	TXN
4	Ground
5	RXN
6	RXP
7	Ground

Floppy Drive Connector

The floppy connector is designated "Floppy". See the table below for pin definitions.

Floppy Drive Connector Pin Definitions (Floppy)			
Pin#	Definition	Pin #	Definition
1	Ground	2	FDHDIN
3	Ground	4	Reserved
5	Key	6	FDEDIN
7	Ground	8	Index
9	Ground	10	Motor Enable
11	Ground	12	Drive Select B
13	Ground	14	Drive Select B
15	Ground	16	Motor Enable
17	Ground	18	DIR
19	Ground	20	STEP
21	Ground	22	Write Data
23	Ground	24	Write Gate
25	Ground	26	Track 00
27	Ground	28	Write Protect
29	Ground	30	Read Data
31	Ground	32	Side 1 Select
33	Ground	34	Diskette

Chapter 6

Advanced Chassis Setup

This chapter covers the steps required to install components and perform simple maintenance on the SC743TQ-865-SQ chassis. Following the component installation steps in the order given will eliminate most common problems. If some steps are unnecessary, skip ahead to the step that follows. Refer to Chapter 2 for instructions on installing the system as a 4U rackmount.

Tools Required: The only tool you will need is a Philips screwdriver.

6-1 Static-Sensitive Devices

Static electrical discharge can damage electronic components. To prevent damage to any printed circuit boards (PCBs), it is important to handle them very carefully. The following measures are generally sufficient to protect your equipment from static discharge.

Precautions

- Use a grounded wrist strap designed to prevent static discharge.
- Touch a grounded metal object before removing any board from its antistatic bag.
- Handle a board by its edges only; do not touch its components, peripheral chips, memory modules or gold contacts.
- When handling chips or modules, avoid touching their pins.
- Put the serverboard, add-on cards and peripherals back into their antistatic bags when not in use.
- For grounding purposes, make sure your computer chassis provides excellent conductivity between the power supply, the case, the mounting fasteners and the serverboard.

Unpacking

The serverboard is shipped in antistatic packaging. When unpacking the board, make sure the person handling it is static protected.

Figure 6-1. Chassis Front View

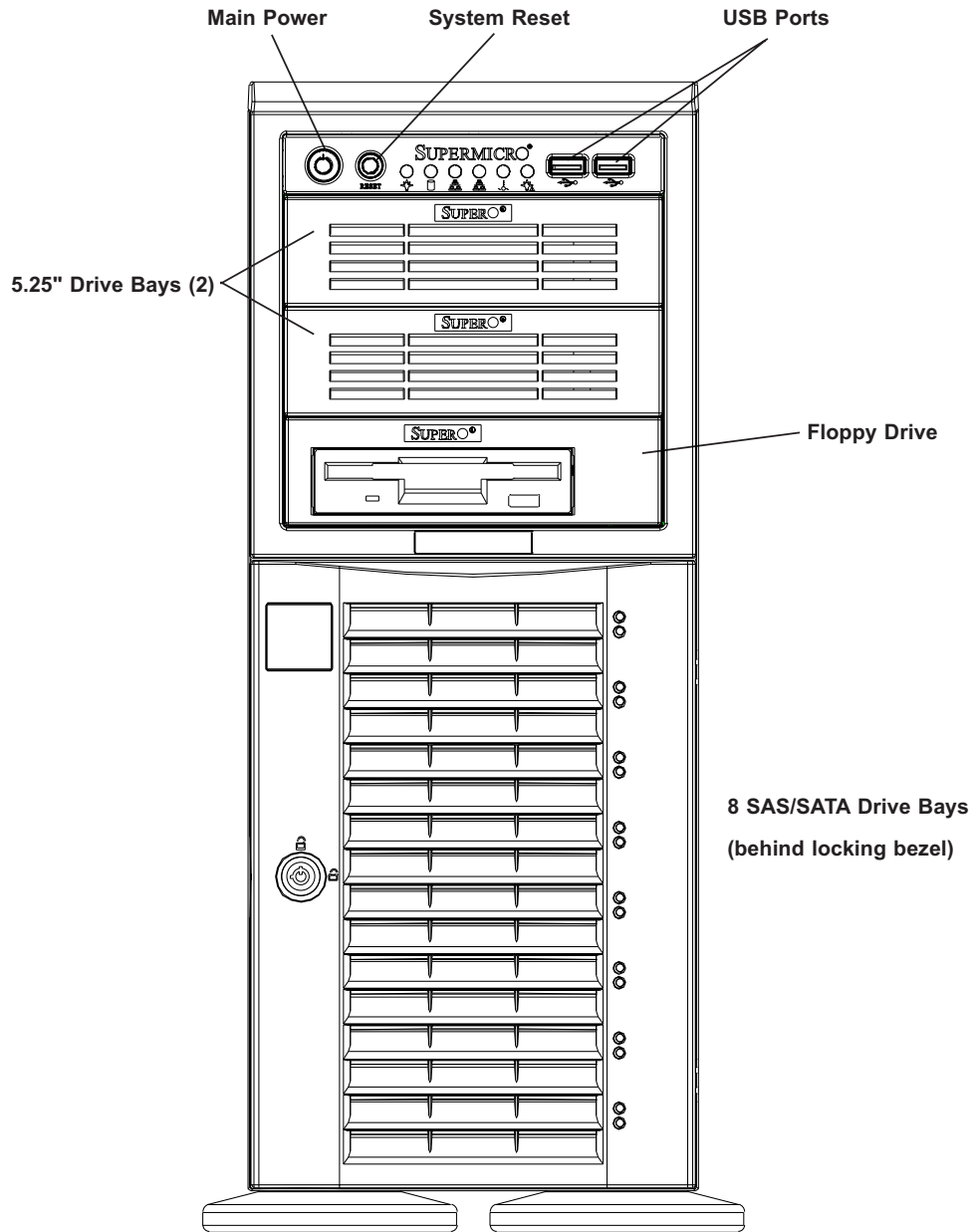







6-2 Front Control Panel

The front control panel must be connected to the JF1 connector on the serverboard to provide you with system status and alarm indications. A ribbon cable has bundled these wires together to simplify this connection.

Connect the cable from JF1 on the serverboard (making sure the red wire plugs into pin 1) to the appropriate connector on the front control panel PCB (printed circuit board). Pull all excess cabling over to the control panel side of the chassis. The LEDs on the control panel inform you of system status - see Figure 6-2 for details. See Chapter 5 for details on JF1.

Figure 6-2. Front Control Panel LEDs

Power		Indicates power is being supplied to the system.
HDD		Indicates IDE device and hard drive activity. On the SC743TQ-865-SQ, this LED indicates SAS/SATA hard drive activity when flashing.
NIC1		Indicates network activity on LAN port 1.
NIC2		Indicates network activity on LAN port 2
Overheat/Fan Fail		When this LED flashes, it indicates a fan failure. When on continuously it indicates an overheat condition (see Chapter 3 for details).
Power Fail		Indicates a power supply fan failure. An alarm will also sound, which can be turned off with the reset switch on the back of the power supply.

6-3 System Fans

Two 8-cm PWM chassis fans provide air intake while one 9-cm PWM exhaust fan expels hot air from the chassis. All are low-noise fans that result in very low system noise levels. The chassis is also fitted with an air shroud to concentrate the flow of cooling air through the system. The fans should be connected to headers on the serverboard (see Chapter 5).

The power supply includes redundant cooling fans. If one fan fails, the rpm of the remaining fan will ramp up its rpm to provide sufficient cooling. The Power Fail LED will illuminate and an audible alarm will sound, which can be silenced with a button on the power supply. If a power supply fan fails, you should replace the power supply at your earliest convenience.

Fan Failure

Under normal operation, the chassis fans, the exhaust fan and the power supply fans run continuously. The chassis fans are hot-swappable and can be replaced without powering down the system.

Replacing Chassis Cooling Fans

Removing a Fan

1. First locate the failed chassis fan by removing the top/left chassis cover (see Chapter 2 for details). Locate the fan that has stopped working.
2. Depress the locking tab on the failed fan: on a chassis fan, push the tab on the side of the housing inward, on the exhaust fan push down on the colored tab.
3. With the tab depressed, pull the unit straight out (see Figure 6-3). The wiring for these fans has been designed to detach automatically.

Installing a New Fan

1. Replace the failed fan with an identical one (available from Supermicro)
2. Install it in the same position and orientation as the one you removed; it should click into place when fully inserted.
3. Check that the fan is working then replace the top/left side chassis panel.

Figure 6-3. Removing a Chassis Fan

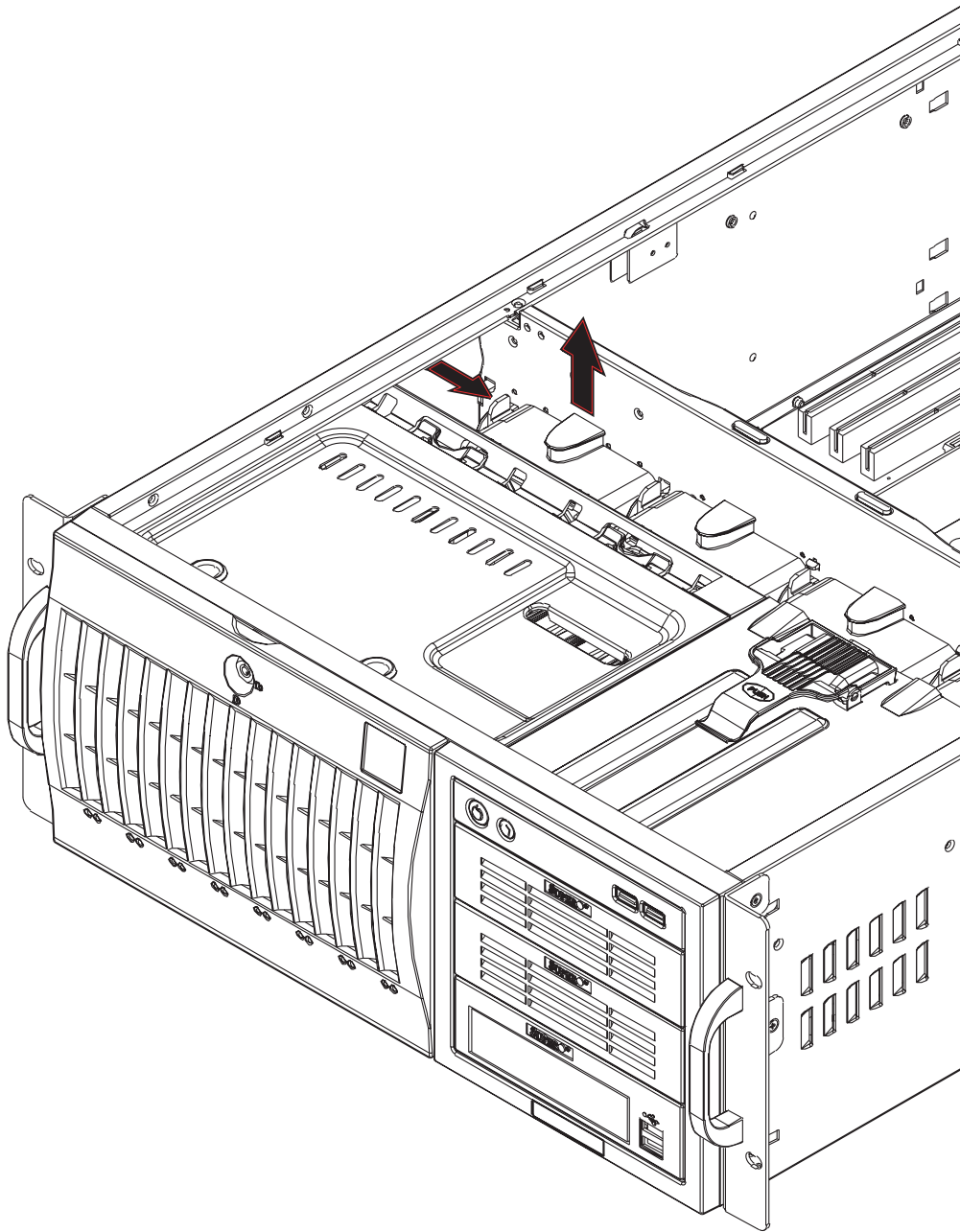

6-4 Drive Bay Installation

A total of eight SAS (or six SATA) drives may be housed in the SC743TQ-865-SQ chassis. The drive IDs are preconfigured as 0 through 7 (or 5) in order from bottom to top (or from left to right if rackmounted). A bezel covers the drive area but does not need to be removed to access the drives; simply swing open the bezel. If you wish to remove the bezel piece, push on the three tabs on the inside of the left lip of the front chassis cover. Then slightly swing out the same (left) side of the cover - about ½ inch only. Remove by pushing on the open side of the cover to remove it from the chassis (do not try to swing or pull it straight out after opening the left side).



Regardless of how many SAS/SATA drives are installed, all drive carriers must remain in the drive bays to promote proper airflow.

Installing/Removing SAS/SATA Drives

The SAS/SATA drive carriers are all easily accessible at the front of the chassis. These drives are hot-swappable, meaning they can be removed and installed without powering down the system.

1. Open the front bezel then push the release button located beside the drive LEDs.
2. Swing the handle fully out and then use it to pull the unit straight out.

Note: Your operating system must have RAID support to enable the hot-swap capability of the SAS/SATA drives.

Mounting a SAS/SATA drive in a Drive Carrier

The SAS/SATA drive carriers help to promote proper airflow for the system. For this reason, even carriers without SAS/SATA drives must remain in the server.

1. Insert the drive into the carrier with the printed circuit board side facing down so that the mounting holes align with those in the carrier.
2. Secure the drive to the carrier with four screws (see Figure 6-5).

Figure 6-4. Removing a SAS/SATA Drive Carrier

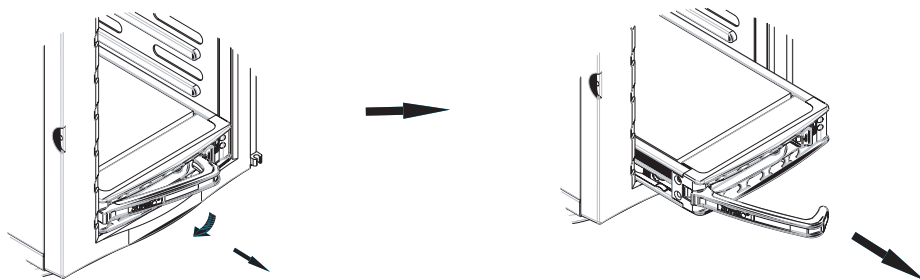
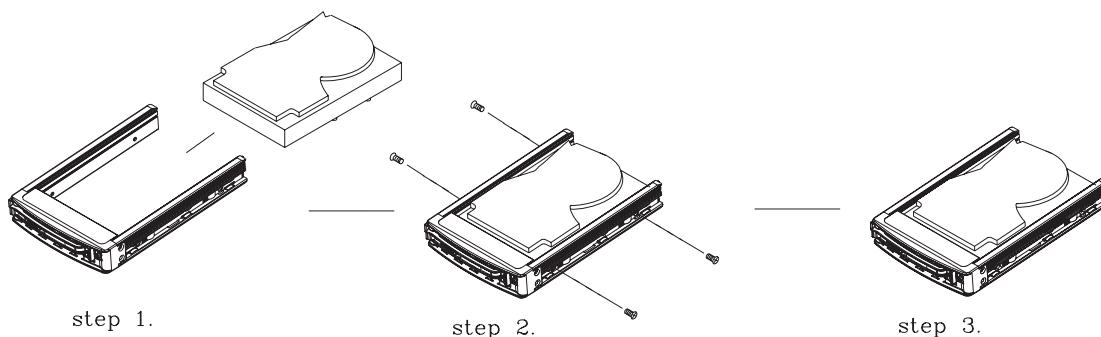

Figure 6-5. Mounting a SAS/SATA Drive in a Carrier



Important! Use extreme caution when working around the SAS/SATA backplane. Do not touch the backplane with any metal objects and make sure no ribbon cables touch the backplane or obstruct the airflow holes.

SAS/SATA Backplane

The SAS/SATA drives plug into a SAS/SATA backplane. A data cables (CBL-061L) for each drive and two SAS/SATA LED cables (CBL-0157L) need to be connected from the serverboard to the appropriate connectors on the backplane. You cannot cascade the SAS/SATA backplane.

Installing Components in the 5.25" Drive Bays

The 7045A-C3/7045A-CT has two 5.25" drive bays. Components such as an extra floppy drive, IDE hard drives or CD-ROM drives can be installed into these 5.25" drive bays.

Removing the Empty Drive Bay

1. First power down the system.
2. Remove the top/left chassis cover to access the drive components.
3. With the cover off, remove the screws that secure the drive carrier to the chassis (one side only) then push the entire empty drive carrier out from the back.

Adding a DVD/CD-ROM Drive

1. Remove the guide plates (one on each side) from the empty drive carrier and screw them into both sides of the DVD/CD-ROM drive using the holes provided.
2. Slide the DVD/CD-ROM into the bay and secure it to the chassis with the drive carrier screws you first removed.
3. Attach the power and data cables to the drive.
4. Replace the top/left chassis cover and restore power to the system.

Adding an IDE or Floppy Drive

1. Install an IDE or floppy into one of the removed empty drive carriers with the printed circuit board side toward the carrier so that the drive's mounting holes align with those in the carrier.
2. Secure the drive to the carrier with screws then slide the assembly into the bay and secure it to the chassis with the drive carrier screws you first removed.
3. Attach the power and data cables to the drive.
4. Replace the top/left chassis cover and restore power to the system.

Note: A red wire typically designates the location of pin 1. Drive carriers should remain in any empty drive bays to maintain proper airflow within the chassis.

6-5 Power Supply

The SuperWorkstation 7045A-C3/7045A-CT has a single 865 watt power supply. This power unit is equipped with low-noise technology, making the system ideal for workstation environments.

The power supply has an auto-switching capability that enable it to automatically sense and operate with 100 or 240 volt inputs.

Power Supply Failure

If the power supply unit fails, the system will shut down and you will need to replace the power supply unit. Replace with the same model - PWS-865-PQ, which can be ordered directly from Supermicro (see Contact Information in the Preface). As there is only one power supply unit, the server must be powered down before removing and/or replacing the power supply for whatever reason.

Replacing the Power Supply

1. First power down the server.
2. Unplug the power cord from the power supply module.
3. Remove the screws that secure the module to the chassis then pull it completely out.
4. Replace the failed unit with another unit of the exact same part number (PWS-865-PQ).
5. Gently but firmly push the new unit all the way into the open bay.
6. Secure it to the chassis using the screws you previously removed.
7. Finish by replacing the chassis left/top cover and then plugging the power cord back into the new module you just added.
8. Push the power button to restart the system.

Notes

Chapter 7

BIOS

7-1 Introduction

This chapter describes the Phoenix BIOS™ Setup utility for the X7DCA-3/X7DCA-i. The Phoenix ROM BIOS is stored in a flash chip and can be easily upgraded using a floppy disk-based program.

Note: Due to periodic changes to the BIOS, some settings may have been added or deleted and might not yet be recorded in this manual. Please refer to the Manual Download area of the Supermicro web site for any changes to the BIOS that may not be reflected in this manual.

System BIOS

The BIOS is the Basic Input Output System used in all IBM® PC, XT™, AT®, and PS/2® compatible computers. The Phoenix BIOS stores the system parameters, types of disk drives, video displays, etc. in the CMOS. The CMOS memory requires very little electrical power. When the computer is turned off, a backup battery provides power to the CMOS Logic, enabling it to retain system parameters. Each time the computer is powered on, the computer is configured with the values stored in the CMOS Logic by the system BIOS, which gains control at boot up.

How To Change the Configuration Data

The CMOS information that determines the system parameters may be changed by entering the BIOS Setup utility. This Setup utility can be accessed by pressing the <Delete> key at the appropriate time during system boot. (See below.)

Starting the Setup Utility

Normally, the only visible POST (Power On Self Test) routine is the memory test. As the memory is being tested, press the <Delete> key to enter the main menu of the BIOS Setup utility. From the main menu, you can access the other setup screens, such as the Security and Power menus. Beginning with Section 7-3, detailed descriptions are given for each parameter setting in the Setup utility.



Warning: Do not shut down or reset the system while updating BIOS to prevent possible boot failure.

7-2 Running Setup

Default settings are in bold text unless otherwise noted.

The BIOS setup options described in this section are selected by choosing the appropriate text from the main BIOS Setup screen. All displayed text is described in this section, although the screen display is often all you need to understand how to set the options (see the next page).

When you first power on the computer, the Phoenix BIOS™ is immediately activated.

While the BIOS is in control, the Setup program can be activated in one of two ways:

1. By pressing <Delete> immediately after turning the system on, or
2. When the message shown below appears briefly at the bottom of the screen during the POST (Power On Self-Test), press the <Delete> key to activate the main Setup menu:

Press the <Delete> key to enter Setup

7-3 Main BIOS Setup

All main Setup options are described in this section. The main BIOS Setup screen is displayed below.

Use the Up/Down arrow keys to move among the different settings in each menu. Use the Left/Right arrow keys to change the options for each setting.

Press the <Esc> key to exit the CMOS Setup Menu. The next section describes in detail how to navigate through the menus.

Items that use submenus are indicated with the ► icon. With the item highlighted, press the <Enter> key to access the submenu.

Main BIOS Setup Menu

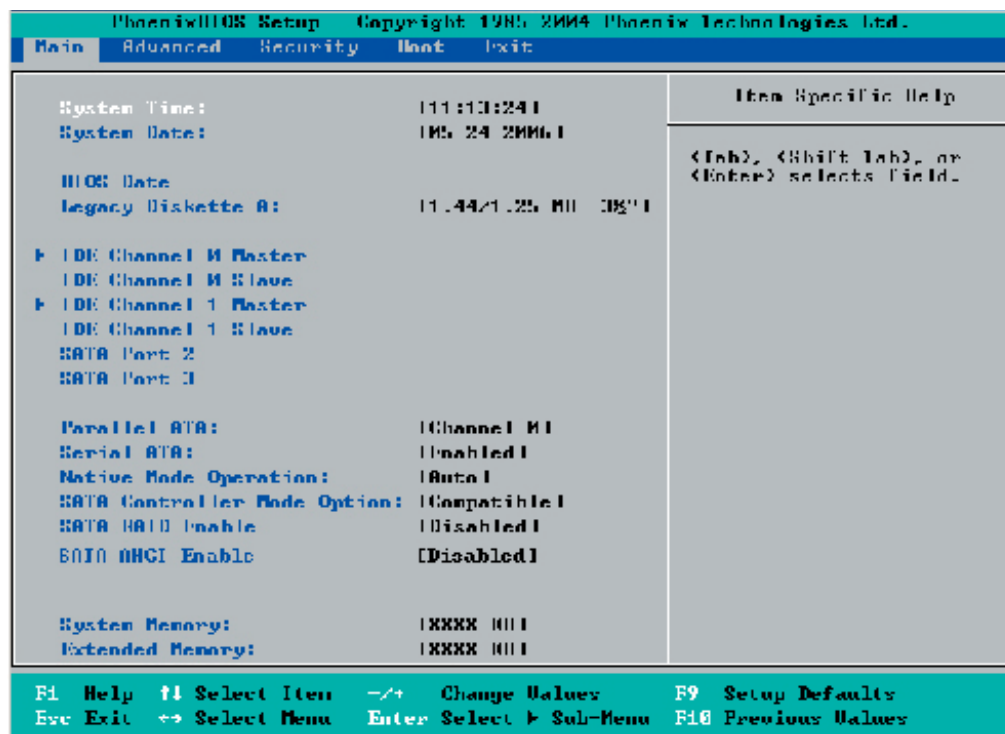

Main Setup Features

System Time

To set the system date and time, key in the correct information in the appropriate fields. Then press the <Enter> key to save the data.

System Date

Using the arrow keys, highlight the month, day and year fields, and enter the correct data. Press the <Enter> key to save the data.

BIOS Date

This field displays the date when this version of BIOS was built.

Legacy Diskette A

This setting allows the user to set the type of floppy disk drive installed as diskette A. The options are Disabled, 360Kb 5.25 in, 1.2MB 5.25 in, 720Kb 3.5 in, **1.44/1.25MB**, 3.5 in and 2.88MB 3.5 in.

► IDE Primary Master/Slave, IDE Secondary Master/Slave, SATA Port3, SATA Port4 and Ext. Primary Master/Slave

These settings allow the user to set the parameters of IDE Primary Master/Slave, IDE Secondary Master/Slave, SATA Port 3, SATA Port 4 and Ext. Primary Master/Slave. Hit <Enter> to activate the following sub-menu screen for detailed options of these items. Set the correct configurations accordingly. The items included in the sub-menu are:

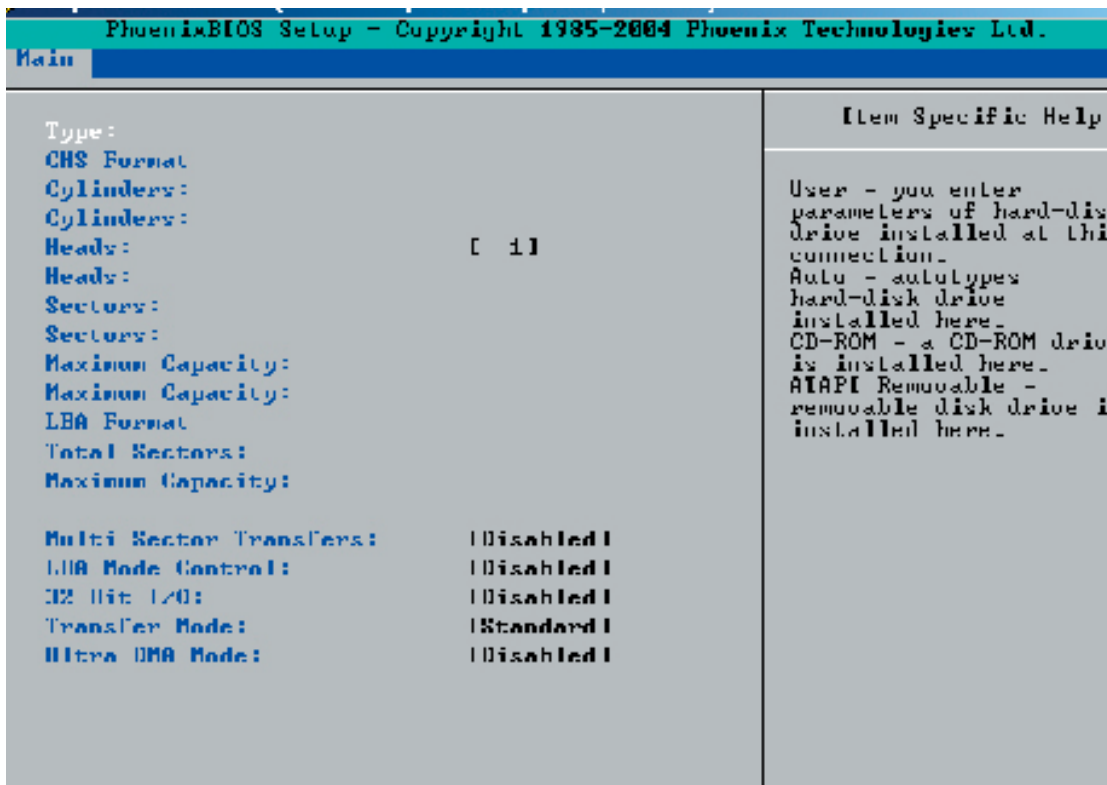

Type

This option allows the user to select the type of IDE hard drive. The option **Auto** will allow the BIOS to automatically configure the parameters of the HDD installed at the connection. Enter a number between 1 to 39 to select a predetermined HDD type. Select User to allow the user to enter the parameters of the HDD installed. Select CDROM if a CDROM drive is installed. Select ATAPI if a removable disk drive is installed.

CHS Format (Available for Primary/Master only)

The following items will be displayed by the BIOS:

Type: This item displays the type of IDE or SATA Device.

Cylinders: This item indicates the status of Cylinders.

Headers: This item indicates the number of headers.

Sectors: This item displays the number of sectors.

Maximum Capacity: This item displays the maximum storage capacity of the system.

LBA Format

The following items will be displayed by the BIOS:

Total Sectors: This item displays the number of total sectors available in the LBA Format.

Maximum Capacity: This item displays the maximum capacity in the LBA Format.

Multi-Sector Transfers

This item allows the user to specify the number of sectors per block to be used in multi-sector transfer. The options are **Disabled**, 4 Sectors, 8 Sectors, and 16 Sectors.

LBA Mode Control

This item determines whether the Phoenix BIOS will access the IDE Channel 0 Master Device via the LBA mode. The options are Enabled and **Disabled**.

32 Bit I/O

This option allows the user to enable or disable the function of 32-bit data transfer. The options are Enabled and **Disabled**.

Transfer Mode

This option allows the user to set the transfer mode. The options are **Standard**, Fast PIO1, Fast PIO2, Fast PIO3, Fast PIO4, FPIO3/DMA1 and FPIO4/DMA2.

Ultra DMA Mode

This option allows the user to select Ultra DMA Mode. The options are **Disabled**, Mode 0, Mode 1, Mode 2, Mode 3, Mode 4, and Mode 5.

Serial ATA

This setting allows the user to enable or disable the Serial ATA function. The options are Disabled and **Enabled**.

Native Mode Operation

Select the native mode for ATA. The options are Parallel ATA, Serial ATA, Both and **Auto**.

Serial ATA (SATA) RAID Enable

Select Enable to enable Serial ATA RAID Functions. (For a Windows OS environment, use the RAID driver if this feature is set to Enabled. If this item is set to **Disabled**, the item SATA AHCI Enable will be available.) The options are Enabled and **Disabled**.

ICH RAID Code Base (Available when SATA RAID is Enabled)

Select Intel to enable Intel's SATA RAID firmware. Select LSI to use LSI's HostRAID firmware. The options are **Intel** and LSI.

SATA AHCI (Available when SATA RAID is Disabled)

Select Enable to enable the function of Serial ATA Advanced Host Interface. (Use caution when enabling this function. This feature is for advanced programmers only.) The options are Enabled and **Disabled**.

System Memory

This display informs you how much system memory is recognized as being present in the system.

Extended Memory

This display informs you how much extended memory is recognized as being present in the system.

7-4 Advanced Setup

Choose Advanced from the Phoenix BIOS Setup Utility main menu with the arrow keys. You should see the following display. The items with a triangle beside them have sub menus that can be accessed by highlighting the item and pressing <Enter>.

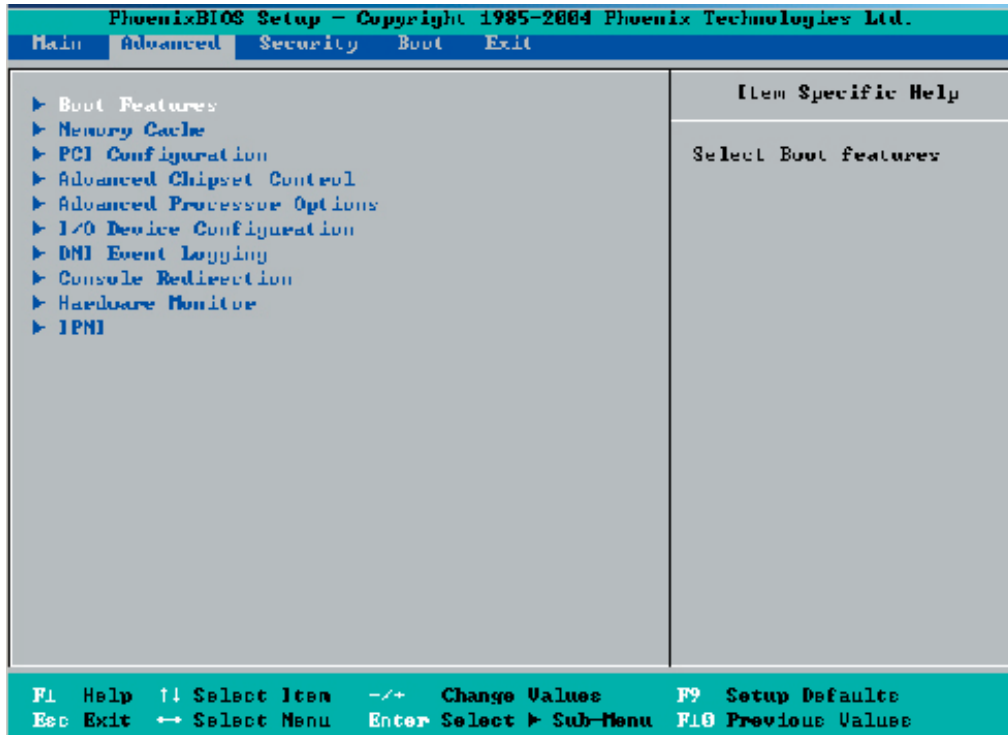

► Boot Features

Access the submenu to make changes to the following settings.

QuickBoot Mode

If enabled, this feature will speed up the POST (Power On Self Test) routine by skipping certain tests after the computer is turned on. The settings are **Enabled** and Disabled. If Disabled, the POST routine will run at normal speed.

QuietBoot

This setting allows you to **Enable** or Disable the graphic logo screen during boot-up.

ACPI Mode

Use the setting to determine if you want to employ ACPI (Advanced Configuration and Power Interface) power management on your system. The options are **Yes** and No.

ACPI Sleep Mode

This feature allows you to decide which ACPI power management mode to use when in sleep mode. The options are **S1**, S3 and S1S3.

Power Button Behavior

If set to **Instant-Off**, the system will power off immediately as soon as the user hits the power button. If set to 4-sec., the system will power off when the user presses the power button for 4 seconds or longer. The options are instant-off and 4-sec override.

Resume On Modem Ring

Select On to “wake your system up” when an incoming call is received by your modem. The options are On and **Off**.

Power Loss Control

This setting allows you to choose how the system will react when power returns after an unexpected loss of power. The options are Stay Off, Power On and **Last State**.

Watch Dog

If enabled, this option will automatically reset the system if the system is not active for more than 5 minutes. The options are Enabled and **Disabled**.

Summary Screen

This setting allows you to **Enable** or Disable the summary screen which displays the system configuration during bootup.

► Memory Cache

Cache System BIOS Area

This setting allows you to designate a reserve area in the system memory to be used as a System BIOS buffer to allow the BIOS to write (cache) data into this reserved memory area. Select **Write Protect** to enable this function, and this area will be reserved for BIOS ROM access only. Select Uncached to disable this function and make this area available for other devices.

Cache Video BIOS Area

This setting allows you to designate a reserve area in the system memory to be used as a Video BIOS buffer to allow the BIOS to write (cache) data into this reserved memory area. Select **Write Protect** to enable the function and this area

will be reserved for Video BIOS ROM access only. Select Uncached to disable this function and make this area available for other devices.

Cache Base 0-512K

If enabled, this feature will allow the data stored in the base memory area: block 0-512K to be cached (written) into a buffer, a storage area in the Static DRAM (SDRAM) or to be written into the L1, L2 cache inside the CPU to speed up CPU operations. Select Uncached to disable this function. Select Write Through to allow data to be cached into the buffer and written into the system memory at the same time. Select Write Protect to prevent data from being written into the base memory area of Block 0-512K. Select Write Back to allow the CPU to write data back directly from the buffer without writing data to the System Memory for fast CPU data processing and operation. The options are Uncached, Write Through, Write Protect and **Write Back**.

Cache Base 512K-640K

If enabled, this feature will allow the data stored in the memory area: 512K-640K to be cached (written) into a buffer, a storage area in the Static DRAM (SDRAM) or written into the L1, L2, L3 cache inside the CPU to speed up CPU operations. Select Uncached to disable this function. Select Write Through to allow data to be cached into the buffer and written into the system memory at the same time. Select Write Protect to prevent data from being written into the base memory area of Block 512-640K. Select Write Back to allow the CPU to write data back directly from the buffer without writing data to the System Memory for fast CPU data processing and operation. The options are Uncached, Write Through, Write Protect and **Write Back**.

Cache Extended Memory

If enabled, this feature will allow the data stored in the extended memory area to be cached (written) into a buffer, a storage area in the Static DRAM (SDRAM) or written into the L1, L2, L3 cache inside the CPU to speed up CPU operations. Select Uncached to disable this function. Select Write Through to allow data to be cached into the buffer and written into the system memory at the same time. Select Write Protect to prevent data from being written into the extended memory area above 1MB. Select Write Back to allow the CPU to write data back directly from the buffer without writing data to the System Memory for fast CPU data processing and operation. The options are Uncached, Write Through, Write Protect and **Write Back**.

Discrete MTRR Allocation

If enabled, MTRRs (Memory Type Range Registers) are configured as distinct, separate units and cannot be overlapped. If enabled, the user can achieve better

graphic effects when using a Linux graphic driver that requires the write-combining configuration with 4GB or more memory. The options are Enabled and **Disabled**.

► **PCI Configuration**

Access the submenu to make changes to the following settings for PCI devices.

Onboard GLAN1/Onboard GLAN2 (Gigabit- LAN) OPRON Configure

Select Enabled to allow the system to boot from the GLAN1 connection or the GLAN 2 connection. The options are **Disabled** and Enabled.

Reset Configuration Data

If set to Yes, this setting clears the Extended System Configuration Data (ESCD) area. The options are Yes and **No**.

► **Slot1 PCI-X 133/100 MHz, Slot2 PCI-X 133/100 MHz, Slot3 PCI 33 MHz, Slot 4 PCI-Exp. x8/x4, Slot 5 PCI 33 MHz and Slot 6 PCI Exp. x16**

Access the submenu for each of the settings above to make changes to the following:

Option ROM Scan

When enabled, this setting will initialize the device expansion ROM. The options are **Enabled** and Disabled.

Enable Master

This setting allows you to enable the selected device as the PCI bus master. The options are **Enabled** and Disabled.

Latency Timer

This setting allows you to set the clock rate for Bus Master. A high-priority, high-throughput device may benefit from a greater clock rate. The options are **Default**, 0020h, 0040h, 0060h, 0080h, 00A0h, 00C0h and 00E0h. For Unix, Novell and other Operating Systems, please select "Other". If a drive fails after installing new software, you might want to change this setting and try again. A different OS requires a different Bus Master clock rate.

Large Disk Access Mode

This setting determines how large hard drives are to be accessed. The options are **DOS** or Other (for Unix, Novelle NetWare and other operating systems).

► Advanced Chipset Control

Access the submenu to make changes to the following settings.



Warning: Use caution when changing the Advanced settings. Incorrect setup, a very high DRAM frequency or an incorrect DRAM timing may cause the system become unstable. If this occurs, reset the stting to the default setting.

Crystal Beach Features

Select Enabled to use Intel's I/O AT (Acceleration Technology) to accelerate the performance of TOE devices. (A TOE device is a specialized, dedicated processor that is installed on an add-on card or a network card to handle some or all packet processing of the add-on card. For this serverboard, the TOE device is built inside the ESB2 South Bridge chip.) The options are **Enabled** and Disabled.

SERR Signal Condition

This setting specifies the ECC Error conditions that an SERR# is to be asserted. The options are None, **Single Bit**, Multiple Bit, and Both.

4GB PCI Hole Granularity

This feature allows you to select the granularity of PCI hole for PCI slots. If MTRRs are not enough, this option may be used to reduce MTRR occupation. The options are: **256 MB**, 512 MB, 1GB and 2GB.

Azalia Audio

Select Auto to allow BIOS to automatically enable the onboard Azalia audio if detected. The options are **Auto** and Disabled.

Route Port 80h Cycles to

This feature allows the user to decide which bus to send debug information to. The options are Disabled, PCI and **LPC**.

Enabling Multi-Media Timer

Select Yes to activate a set of timers that are alternative to the traditional 8254 timers for the OS use. The options are Yes and **No**.

USB Host Controller 1

Select Enabled to activate USB Host Controller 1. The settings are **Enabled** and Disabled.

USB Host Controller 2

Select Enabled to activate USB Host Controller 2. The settings are **Enabled** and Disabled.

Legacy USB Support

This setting allows you to enable support for Legacy USB devices. The settings are **Enabled** and Disabled.

► Advanced Processor Options

Access the submenu to make changes to the following settings.

CPU Speed

This is a display that indicates the speed of the installed processor.

Frequency Ratio (Available when supported by the CPU)

The feature allows the user to set the internal frequency multiplier for the CPU. The options are **Default**, x12, x13, x14, x15, x16, x17 and x18.

Core-Multi-Processing (Available when supported by the CPU)

Set to Enabled to use a processor's Second Core and beyond. (Please refer to Intel's web site for more information.) The options are Disabled and **Enabled**.

Machine Checking (Available when supported by the CPU)

Set to Enabled to activate the function of Machine Checking and allow the CPU to detect and report hardware (machine) errors via a set of model-specific registers (MSRs). The options are Disabled and **Enabled**.

Thermal Management 2 (Available when supported by the CPU)

Set to **Enabled** to use Thermal Management 2 (TM2) which will lower CPU voltage and frequency when the CPU temperature reaches a predefined overheat threshold. Set to Disabled to use Thermal Manager 1 (TM1), allowing CPU clocking to be regulated via CPU Internal Clock modulation when the CPU temperature reaches the overheat threshold.

C1 Enhanced Mode (Available when supported by the CPU)

Set to Enabled to enable Enhanced Halt State to lower CPU voltage/frequency to prevent overheat. The options are Enabled and **Disabled**. **Note:** please refer to Intel's web site for detailed information.

Execute Disable Bit (Available when supported by the CPU and the OS)

Set to Enabled to enable Execute Disable Bit and allow the processor to classify areas in memory where an application code can execute and where it cannot, and thus preventing a worm or a virus from inserting and creating a flood of codes to overwhelm the processor or damage the system during an attack. (This feature is only available if your OS and your CPU support the Execute Disable Bit function.) The options are **Disabled** and Enabled. For more information regarding hardware/software support for this function, please refer to Intel's and Microsoft's web sites.

Adjacent Cache Line Prefetch (Available when supported by the CPU)

The CPU fetches the cache line for 64 bytes if this option is set to Disabled. The CPU fetches both cache lines for 128 bytes as comprised if Enabled. The options are **Disabled** and Enabled.

Hardware Prefetcher (Available when supported by the CPU)

Set to this option to **enabled** to enable the hardware components that are used in conjunction with software programs to prefetch data in order to shorten execution cycles and maximize data processing efficiency. The options are Disabled and **Enabled**.

Echo TPR

Set to **Enabled** to prevent xTPR messages from being sent to the system. The options are **Disabled** and Enabled.

Intel <R> Virtualization Technology (Available when supported by the CPU)

Select Enabled to use the feature of Virtualization Technology to allow one platform to run multiple operating systems and applications in independent partitions, creating multiple "virtual" systems in one physical computer. The options are Enabled and **Disabled**. Note: If there is any change to this setting, you will need to power off and restart the system for the change to take effect. Please refer to Intel's web site for detailed information.

Intel EIST Support (Available when supported by the CPU)

Select Enabled to use the Enhanced Intel SpeedStep Technology and allows the system to automatically adjust processor voltage and core frequency in an effort to reduce power consumption and heat dissipation. The options are Enabled and **Disabled**. Please refer to Intel's web site for detailed information.

► CPU Cache Control

Access the submenu to make changes to the following settings.

Direct Cache Access (Available when supported by the CPU)

Set to Enable to route inbound network IO traffic directly into processor caches to reduce memory latency and improve network performance. The options are **Disabled** and **Enabled**.

DCA Delay Clocks(Available when supported by the CPU)

This feature allows the user to set the clock delay setting from snoop to prefetch for Direct Cache Access. Select a setting from 8 (bus cycles) to 120 (bus cycles) (in 8-cycle increment). The default setting is **32 (bus cycles)**.

► I/O Device Configuration

Access the submenu to make changes to the following settings.

KBC Clock Input

This setting allows you to select clock frequency for KBC. The options are 6MHz, 8MHz, **12MHz** and 16MHz.

Serial Port A

This setting allows you to assign control of serial port A. The options are **Enabled** (user defined), **Disabled** and **Auto** (BIOS or OS controlled).

Base I/O Address

This setting allows you to select the base I/O address for serial port A. The options are **3F8**, **2F8**, **3E8** and **2E8**.

Interrupt

This setting allows you to select the IRQ (interrupt request) for serial port A. The options are **IRQ3** and **IRQ4**.

Serial Port B

This setting allows you to assign control of serial port B. The options are **Enabled** (user defined), **Disabled**, **Auto** (BIOS controlled) and **OS Controlled**.

Mode

This setting allows you to set the type of device that will be connected to serial port B. The options are **Normal** and **IR** (for an infrared device).

Base I/O Address

This setting allows you to select the base I/O address for serial port B. The options are 3F8, **2F8**, 3E8 and 2E8.

Interrupt

This setting allows you to select the IRQ (interrupt request) for serial port B. The options are **IRQ3** and IRQ4.

Parallel Port

This setting allows you to assign control of the parallel port. The options are **Enabled** (user defined), Disabled and Auto (BIOS or OS controlled).

Base I/O Address

Select the base I/O address for the parallel port. The options are **378**, 278 and 3BC.

Interrupt

This setting allows you to select the IRQ (interrupt request) for the parallel port. The options are IRQ5 and **IRQ7**.

Mode

This feature allows you to specify the parallel port mode. The options are Output only, Bi-Directional, EPP and **ECP**.

DMA Channel

This item allows you to specify the DMA channel for the parallel port. The options are DMA1 and **DMA3**.

Floppy Disk Controller

This setting allows you to assign control of the floppy disk controller. The options are **Enabled** (user defined), Disabled and Auto (BIOS and OS controlled).

Base I/O Address

This setting allows you to select the base I/O address for the Floppy port. The options are **Primary** and Secondary.

► DMI Event Logging

Access the submenu to make changes to the following settings.

Event Log Validity

This is a display to inform you of the event log validity. It is not a setting.

Event Log Capacity

This is a display to inform you of the event log capacity. It is not a setting.

View DMI Event Log

Highlight this item and press <Enter> to view the contents of the event log.

Event Logging

This setting allows you to **Enable** or Disable event logging.

ECC Event Logging

This setting allows you to **Enable** or Disable ECC event logging.

Mark DMI Events as Read

Highlight this item and press <Enter> to mark the DMI events as read.

Clear All DMI Event Logs

Select Yes and press <Enter> to clear all DMI event logs. The options are Yes and **No**.

► Console Redirection

Access the submenu to make changes to the following settings.

COM Port Address

This item allows you to specify which COM port to direct the remote console to Onboard COM A or Onboard COM B. This setting can also be **Disabled**.

BAUD Rate

This item allows you to set the BAUD rate for the console redirection. The options are 300, 1200, 2400, 9600, **19.2K**, 38.4K, 57.6K and 115.2K.

Console Type

This item allows you to choose the console redirection type. The options are VT100, VT100,8bit, PC-ANSI, 7bit, **PC ANSI**, VT100+ and VT-UTF8.

Flow Control

This item allows you to set the flow control for the console redirection. The options are None, XON/XOFF and **CTS/RTS**.

Console Connection

This item allows you to decide how the console redirection is to be connected: either **Direct** or Via Modem.

Continue CR after POST

This item allows you to decide whether you want to continue with the console redirection after POST routines. The options are On and **Off**.

► Hardware Monitor Logic

Note: The Phoenix BIOS will automatically detect the type of CPU(s) and hardware monitoring chip used on the motherboard and will display the Hardware Monitoring screen accordingly.

CPU Temperature Threshold

This option allows the user to set a CPU temperature threshold that will activate the alarm system when the CPU temperature reaches this pre-set temperature threshold. The hardcode default setting is **80°C**. (The default setting for the Intel 5100 Series CPU is **75°C** and for the 5000 Series CPU is **80°C** - see below).

Temperature Monitoring (Available if supported by the CPU)

This function monitors the following PECI (Platform Environment Control Interface) items: CPU1 Temperature/CPU1 Second Core/CPU2 Temperature/CPU2 Second Core/PECI Agent 1/PECI Agent 2/PECI Agent 3 /PECI Agent 4 Temperature/System Temperature

Fan1-Fan8 Speeds: If the feature of Auto Fan Control is enabled, the BIOS will automatically display the status of the fans indicated in this item.

Fan Speed Control Modes

This feature allows the user to decide how the system controls the speeds of the onboard fans. The CPU temperature and the fan speed are correlative. When the CPU on-die temperature increases, the fan speed will also increase, and vice versa. If the option is set to 3-pin fan, the fan speed is controlled by voltage. If the option is set to 4-pin, the fan speed will be controlled by Pulse Width Modulation (PWM). Select 3-pin if your chassis came with 3-pin fan headers. Select 4-pin if your chassis came with 4-pin fan headers. Select Workstation if your system is used as a Workstation. Select Server if your system is used as a Server. Select Disable to disable the fan speed control function to allow the onboard fans to run at full speed (12V) at all times. The Options are: **1. Disable**, **2. 3-pin (Server)**, **3. 3-pin (Workstation)**, **4. 4-pin (Server)** and **5. 4-pin (Workstation)**.

Voltage Monitoring

The following items will be monitored and displayed: Vcore A, Vcore B, -12V, +12V, P1V5, +3.3V, 5Vsb, 5VDD, P_VTT and Vbat

Note: In a Windows OS environment, the Supero Doctor III settings take precedence over the BIOS settings. When first installed, Supero Doctor III adopts the temperature threshold settings previously set in the BIOS. Any subsequent changes to these thresholds must be made within Supero Doctor, since the SD III settings override the BIOS settings. For the Windows OS to adopt the BIOS temperature threshold settings, please change the SDIII settings to be the same as those set in the BIOS.

► IPMI (Available only when an IPMI card is installed in the system.)

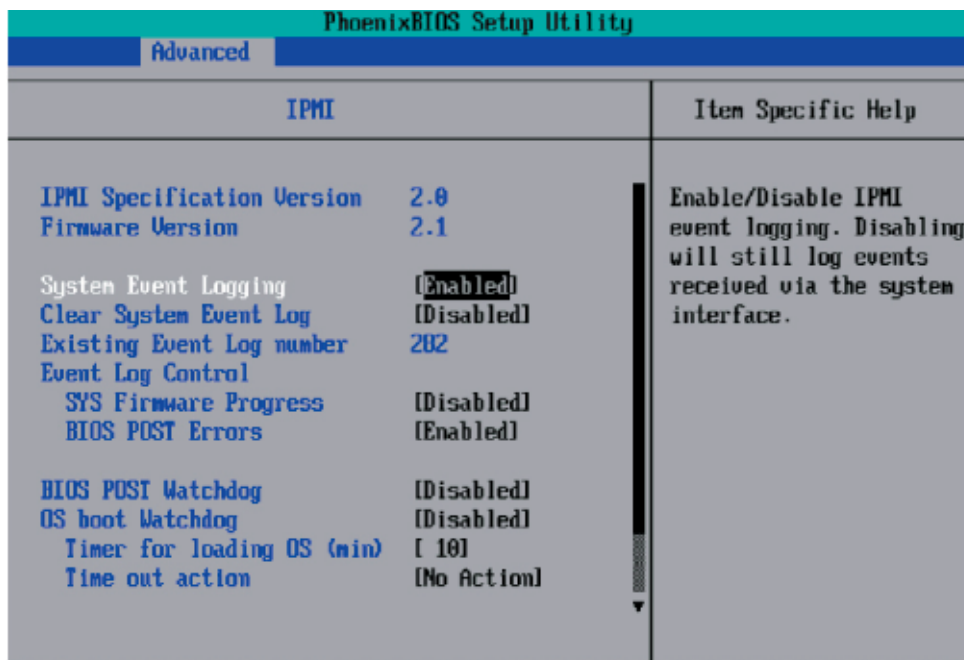

IPMI Specification Version: This item displays the current IPMI Version.

Firmware Version: This item displays the current Firmware Version.

System Event Logging

Select Enabled to enable IPMI Event Logging. When this function is set to Disabled, the system will continue to log events received via system interface. The options are **Enabled** and Disabled.

Clear System Event Logging

Enabling this function to force the BIOS to clear the system event logs during the next cold boot. The options are Enabled and **Disabled**.

Existing Event Log Number

This item displays the number of the existing event log.

Event Log Control**System Firmware Progress**

Enable this function to log the POST progress. The options are Enabled and **Disabled**.

BIOS POST Errors

Enabling this function to log POST errors. The options are Enabled and **Disabled**.

BIOS POST Watch Dog

Set to Enabled to enable POST Watch Dog. The options are Enabled and **Disabled**.

OS Boot Watch Dog

Set to Enabled to enable OS Boot Watch Dog. The options are Enabled and **Disabled**.

Timer for Loading OS (Minutes)

This feature allows the user to set the time value (in minutes) for the previous item: OS Boot Watch Dog by keying-in a desired number in the blank. The default setting is 10 (minutes.) (Please ignore this option when OS Boot Watch Dog is set to "Disabled".)

Time Out Option

This feature allows the user to determine what action to take in an event of a system boot failure. The options are **No Action**, Reset, Power Off and Power Cycles.

► System Event Log/System Event Log (List Mode)

These options display the System Event (SEL) Log and System Event (SEL) Log in List Mode. Items include: SEL (System Event Log) Entry Number, SEL Record ID, SEL Record Type, Time Stamp, Generator ID, SEL Message Revision, Sensor Type, Sensor Number, SEL Event Type, Event Description, and SEL Event Data.

System Event Log					
SEL Entry Number =	1				
SEL Record ID =	0001				
SEL Record Type =	02 - System Event Record				
Timestamp =	02.10.2006 17:11:23				
Generator Id =	20 00				
SEL Message Rev =	04				
Sensor Type =	02 - Voltage				
Sensor Number =	0A - -12V				
SEL Event Type =	01 - Threshold				
Event Description =	Lower Non-critical Going Low, Assertion				
SEL Event Data =	50 06 0E				

F1	Help	↑↓	Select Item	-/+	Change Values	F9	Setup Defaults
Esc	Exit	←	Select Menu	Enter	Select ▶ Sub-Menu	F10	Save and Exit

► Realtime Sensor Data

This feature display information from motherboard sensors, such as temperatures, fan speeds and voltages of various components.

Realtime Sensor Data					
Sensor Type	Sensor Name	Sensor Data	Sensor Units	Lower Limit	Upper Limit
Temp	CPU1 CoreA	48.00	degrees C	0.00	75.00
	CPU1 CoreB	54.00	degrees C	0.00	75.00
	CPU2 CoreA	47.00	degrees C	0.00	75.00
	CPU2 CoreB	46.00	degrees C	0.00	75.00
	System	44.00	degrees C	0.00	75.00
Voltage	CPU1 Core	1.13	Volts	0.97	1.47
	CPU2 Core	1.16	Volts	0.97	1.47
	3.3V	3.30	Volts	2.95	3.62

F1	Help	↑↓	Select Item	-/+	Change Values	F9	Setup Defaults
Esc	Exit	←	Select Menu	Enter	Select ▶ Sub-Menu	F10	Save and Exit

7-5 Security

Choose Security from the Phoenix BIOS Setup Utility main menu with the arrow keys. You should see the following display. Security setting options are displayed by highlighting the setting using the arrow keys and pressing <Enter>. All Security BIOS settings are described in this section.

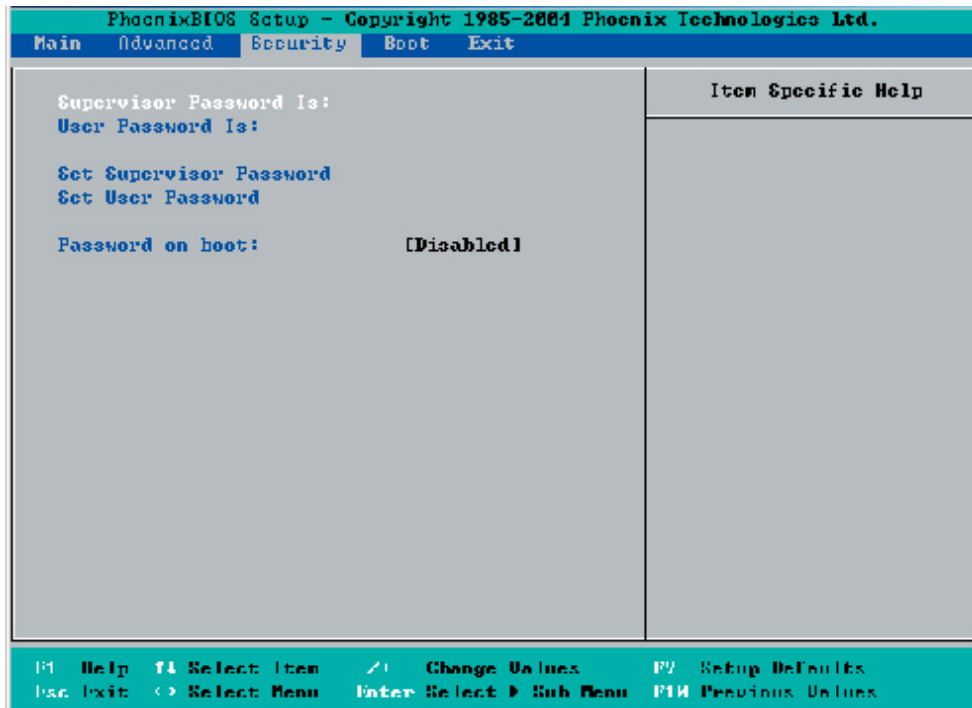

Supervisor Password Is:

This indicates if a supervisor password has been entered for the system. Clear means such a password has not been used and Set means a supervisor password has been entered for the system.

User Password Is:

This indicates if a user password has been entered for the system. Clear means such a password has not been used and Set means a user password has been entered for the system.

Set Supervisor Password

When the item Set Supervisor Password is highlighted, hit the <Enter> key. When prompted, type the Supervisor's password in the dialogue box to set or to change supervisor's password, which allows access to the BIOS.

Set User Password

When the item Set User Password is highlighted, hit the <Enter> key. When prompted, type the user's password in the dialogue box to set or to change the user's password, which allows access to the system at boot-up.

Password on Boot

This setting allows you to determine if a password is required for a user to enter the system at bootup. The options are Enabled (password required) and **Disabled** (password not required).

7-6 Boot

Choose Boot from the Phoenix BIOS Setup Utility main menu with the arrow keys. You should see the following display. See details on how to change the order and specs of boot devices in the Item Specific Help window. All Boot BIOS settings are described in this section.

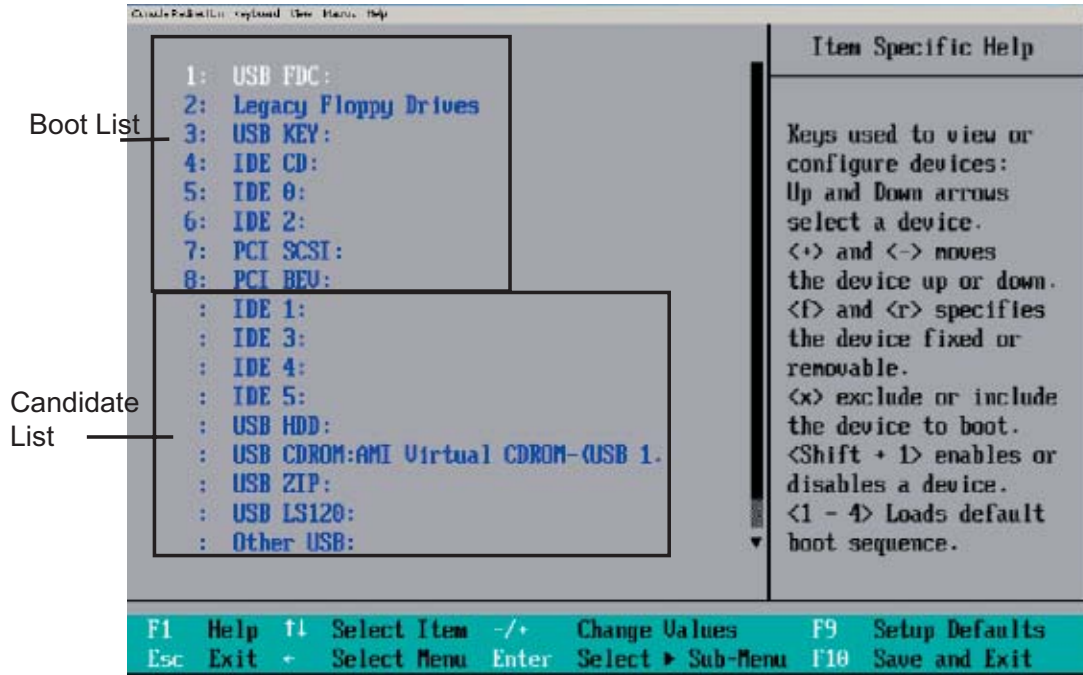

Boot Priority Order/Excluded from Boot Orders

The devices included in the boot list section (above) are bootable devices listed in the sequence of boot order as specified. The boot functions for the devices included in the candidate list (above) are currently disabled.

Use the <+> key or <-> key to move the device up or down. Use the <f> key or the <r> key to specify the type of a USB device: either fixed or removable. You can select one item from the boot list and hit the <x> key to remove it from the list of bootable devices (to make its resource available for other bootable devices). Subsequently, you can select an item from the candidate list and hit the <x> key to remove it from the candidate list and put it in the boot list. This item will then become a bootable device.

See details on how to change the priority of boot order of devices in the "Item Specific Help" window.

7-7 Exit

Choose Exit from the Phoenix BIOS Setup Utility main menu with the arrow keys. You should see the following display. All Exit BIOS settings are described in this section.

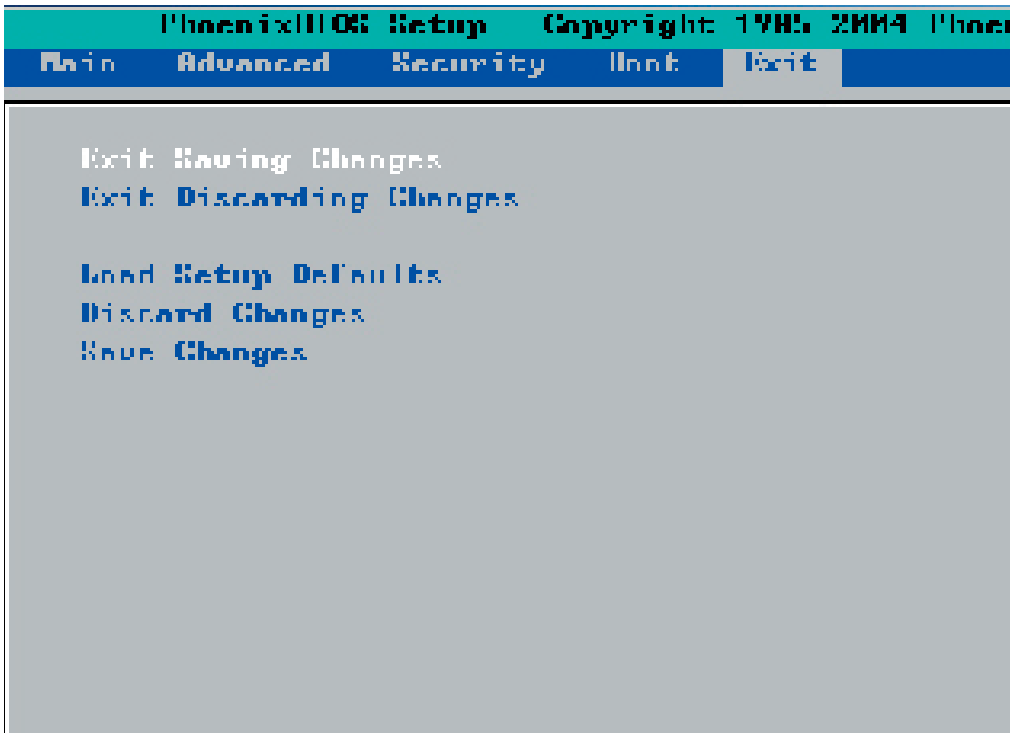

Exit Saving Changes

Highlight this item and hit <Enter> to save any changes you made and to exit the BIOS Setup utility.

Exit Discarding Changes

Highlight this item and hit <Enter> to exit the BIOS Setup utility without saving any changes you may have made.

Load Setup Defaults

Highlight this item and hit <Enter> to load the default settings for all items in the BIOS Setup. These are the safest settings to use.

Discard Changes

Highlight this item and hit <Enter> to discard (cancel) any changes you made. You will remain in the Setup utility.

Save Changes

Highlight this item and hit <Enter> to save any changes you made. You will remain in the Setup utility.

Appendix A

BIOS POST Messages

During the Power-On Self-Test (POST), the BIOS will check for problems. If a problem is found, the BIOS will activate an alarm or display a message. The following is a list of such BIOS messages.

Failure Fixed Disk

Fixed disk is not working or not configured properly. Check to see if fixed disk is attached properly. Run Setup. Find out if the fixed-disk type is correctly identified.

Stuck key

Stuck key on keyboard.

Keyboard error

Keyboard not working.

Keyboard Controller Failed

Keyboard controller failed test. May require replacing keyboard controller.

Keyboard locked - Unlock key switch

Unlock the system to proceed.

Monitor type does not match CMOS - Run SETUP

Monitor type not correctly identified in Setup

Shadow Ram Failed at offset: nnnn

Shadow RAM failed at offset **nnnn** of the 64k block at which the error was detected.

System RAM Failed at offset: nnnn

System RAM failed at offset **nnnn** of in the 64k block at which the error was detected.

Extended RAM Failed at offset: nnnn

Extended memory notworking or not configured properly at offset **nnnn**.

System battery is dead - Replace and run SETUP

The CMOS clock battery indicator shows the battery is dead. Replace the battery and run Setup to reconfigure the system.

System CMOS checksum bad - Default configuration used

System CMOS has been corrupted or modified incorrectly, perhaps by an application program that changes data stored in CMOS. The BIOS installed Default Setup Values. If you do not want these values, enter Setup and enter your own values. If the error persists, check the system battery or contact your dealer.

System timer error

The timer test failed. Requires repair of system board.

Real time clock error

Real-Time Clock fails BIOS hardware test. May require board repair.

Check date and time settings

BIOS found date or time out of range and reset the Real-Time Clock. May require setting legal date (1991-2099).

Previous boot incomplete - Default configuration used

Previous POST did not complete successfully. POST loads default values and offers to run Setup. If the failure was caused by incorrect values and they are not corrected, the next boot will likely fail. On systems with control of **wait states**, improper Setup settings can also terminate POST and cause this error on the next boot. Run Setup and verify that the waitstate configuration is correct. This error is cleared the next time the system is booted.

Memory Size found by POST differed from CMOS

Memory size found by POST differed from CMOS.

Diskette drive A error

Diskette drive B error

Drive A: or B: is present but fails the BIOS POST diskette tests. Check to see that the drive is defined with the proper diskette type in Setup and that the diskette drive is attached correctly.

Incorrect Drive A type - run SETUP

Type of floppy drive A: not correctly identified in Setup.

Incorrect Drive B type - run SETUP

Type of floppy drive B: not correctly identified in Setup.

System cache error - Cache disabled

RAM cache failed and BIOS disabled the cache. On older boards, check the cache jumpers. You may have to replace the cache. See your dealer. A disabled cache

slows system performance considerably.

CPU ID:

CPU socket number for Multi-Processor error.

EISA CMOS not writeable

ServerBIOS2 test error: Cannot write to EISA CMOS.

DMA Test Failed

ServerBIOS2 test error: Cannot write to extended **DMA** (Direct Memory Access) registers.

Software NMI Failed

ServerBIOS2 test error: Cannot generate software NMI (Non-Maskable Interrupt).

Fail-Safe Timer NMI Failed

ServerBIOS2 test error: Fail-Safe Timer takes too long.

device Address Conflict

Address conflict for specified **device**.

Allocation Error for: device

Run ISA or EISA Configuration Utility to resolve resource conflict for the specified **device**.

CD ROM Drive

CD ROM Drive identified.

Entering SETUP ...

Starting Setup program

Failing Bits: nnnn

The hex number **nnnn** is a map of the bits at the RAM address which failed the memory test. Each 1 (one) in the map indicates a failed bit. See errors 230, 231, or 232 above for offset address of the failure in System, Extended, or Shadow memory.

Fixed Disk n

Fixed disk **n** (0-3) identified.

Invalid System Configuration Data

Problem with NVRAM (CMOS) data.

I/O device IRQ conflict

I/O device IRQ conflict error.

PS/2 Mouse Boot Summary Screen:

PS/2 Mouse installed.

nnnn kB Extended RAM Passed

Where **nnnn** is the amount of RAM in kilobytes successfully tested.

nnnn Cache SRAM Passed

Where **nnnn** is the amount of system cache in kilobytes successfully tested.

nnnn kB Shadow RAM Passed

Where **nnnn** is the amount of shadow RAM in kilobytes successfully tested.

nnnn kB System RAM Passed

Where **nnnn** is the amount of system RAM in kilobytes successfully tested.

One or more I2O Block Storage Devices were excluded from the Setup Boot Menu

There was not enough room in the IPL table to display all installed I2O block-storage devices.

Operating system not found

Operating system cannot be located on either drive A: or drive C:. Enter Setup and see if fixed disk and drive A: are properly identified.

Parity Check 1 nnnn

Parity error found in the system bus. BIOS attempts to locate the address and display it on the screen. If it cannot locate the address, it displays **????**. Parity is a method for checking errors in binary data. A parity error indicates that some data has been corrupted.

Parity Check 2 nnnn

Parity error found in the I/O bus. BIOS attempts to locate the address and display it on the screen. If it cannot locate the address, it displays **????**.

Press <F1> to resume, <F2> to Setup, <F3> for previous

Displayed after any recoverable error message. Press <F1> to start the boot process or <F2> to enter Setup and change the settings. Press <F3> to display the previous

screen (usually an initialization error of an **Option ROM**, i.e., an add-on card). Write down and follow the information shown on the screen.

Press <F2> to enter Setup

Optional message displayed during POST. Can be turned off in Setup.

PS/2 Mouse:

PS/2 mouse identified.

Run the I2O Configuration Utility

One or more unclaimed block storage devices have the Configuration Request bit set in the LCT. Run an I2O Configuration Utility (e.g. the SAC utility).

System BIOS shadowed

System BIOS copied to shadow RAM.

UMB upper limit segment address: *nnnn*

Displays the address *nnnn* of the upper limit of **Upper Memory Blocks**, indicating released segments of the BIOS which can be reclaimed by a virtual memory manager.

Video BIOS shadowed

Video BIOS successfully copied to shadow RAM.

Notes

Appendix B

BIOS POST Codes

This section lists the POST (Power On Self Test) codes for the PhoenixBIOS. POST codes are divided into two categories: recoverable and terminal.

Recoverable POST Errors

When a recoverable type of error occurs during POST, the BIOS will display an POST code that describes the problem. BIOS may also issue one of the following beep codes:

- 1 long and two short beeps - video configuration error
- 1 repetitive long beep - no memory detected

Terminal POST Errors

If a terminal type of error occurs, BIOS will shut down the system. Before doing so, BIOS will write the error to port 80h, attempt to initialize video and write the error in the top left corner of the screen. The following is a list of codes that may be written to port 80h.

POST Code	Description
01h	IPMI Initialization
02h	Verify Real Mode
03h	Disable Non-Maskable Interrupt (NMI)
04h	Get CPU type
06h	Initialize system hardware
07h	Disable shadow and execute code from the ROM.
08h	Initialize chipset with initial POST values
09h	Set IN POST flag
0Ah	Initialize CPU registers
0Bh	Enable CPU cache
0Ch	Initialize caches to initial POST values
0Eh	Initialize I/O component
0Fh	Initialize the local bus IDE
10h	Initialize Power Management
11h	Load alternate registers with initial POST values
12h	Restore CPU control word during warm boot
13h	Reset PCI Bus Mastering devices
14h	Initialize keyboard controller
16h	1-2-2-3 BIOS ROM checksum
17h	Initialize cache before memory Auto size

POST Code	Description
18h	8254 timer initialization
1Ah	8237 DMA controller initialization
1Ch	Reset Programmable Interrupt Controller
20h	1-3-1-1 Test DRAM refresh
22h	1-3-1-3 Test 8742 Keyboard Controller
24h	Set ES segment register to 4 GB
28h	Auto size DRAM
29h	Initialize POST Memory Manager
2Ah	Clear 512 kB base RAM
2Ch	1-3-4-1 RAM failure on address line xxxx*
2Eh	1-3-4-3 RAM failure on data bits xxxx* of low byte of memory bus
2Fh	Enable cache before system BIOS shadow
32h	Test CPU bus-clock frequency
33h	Initialize Phoenix Dispatch Manager
36h	Warm start shut down
38h	Shadow system BIOS ROM
3Ah	Auto size cache
3Ch	Advanced configuration of chipset registers
3Dh	Load alternate registers with CMOS values
41h	Initialize extended memory for RomPilot (optional)
42h	Initialize interrupt vectors
45h	POST device initialization
46h	2-1-2-3 Check ROM copyright notice
48h	Check video configuration against CMOS
49h	Initialize PCI bus and devices
4Ah	Initialize all video adapters in system
4Bh	QuietBoot start (optional)
4Ch	Shadow video BIOS ROM
4Eh	Display BIOS copyright notice
4Fh	Initialize MultiBoot
50h	Display CPU type and speed
51h	Initialize EISA board (optional)
52h	Test keyboard
54h	Set key click if enabled
55h	Enable USB devices
58h	2-2-3-1 Test for unexpected interrupts
59h	Initialize POST display service
5Ah	Display prompt "Press <ESC> to enter SETUP"
5Bh	Disable CPU cache

POST Code	Description
5Ch	Test RAM between 512 and 640 kB
60h	Test extended memory
62h	Test extended memory address lines
64h	Jump to UserPatch1
66h	Configure advanced cache registers
67h	Initialize Multi Processor APIC
68h	Enable external and CPU caches
69h	Setup System Management Mode (SMM) area
6Ah	Display external L2 cache size
6Bh	Load custom defaults (optional)
6Ch	Display shadow-area message
70h	Display error messages
72h	Check for configuration errors
76h	Check for keyboard errors
7Ch	Set up hardware interrupt vectors
7Dh	Initialize Intelligent System Monitoring (optional)
7Eh	Initialize coprocessor if present
80h	Disable onboard Super I/O ports and IRQs (optional)
81h	Late POST device initialization
82h	Detect and install external RS232 ports
83h	Configure non-MCD IDE controllers
84h	Detect and install external parallel ports
85h	Initialize PC-compatible PnP ISA devices
86h	Re-initialize onboard I/O ports.
87h	Configure Motherboard Configurable Devices (optional)
88h	Initialize BIOS Data Area
89h	Enable Non-Maskable Interrupts (NMIs)
8Ah	Initialize Extended BIOS Data Area
8Bh	Test and initialize PS/2 mouse
8Ch	Initialize floppy controller
8Fh	Determine number of ATA drives (optional)
90h	Initialize hard-disk controllers
91h	Initialize local-bus hard-disk controllers
92h	Jump to UserPatch2
93h	Build MPTABLE for multi-processor boards
95h	Install CD ROM for boot
96h	Clear huge ES segment register
97h	Fix up Multi Processor table
98h	1-2 Search for option ROMs and shadow if successful. One long, two short beeps on checksum failure

POST Code	Description
99h	Check for SMART Drive (optional)
9Ch	Set up Power Management
9Dh	Initialize security engine (optional)
9Eh	Enable hardware interrupts
9Fh	Determine number of ATA and SCSI drives
A0h	Set time of day
A2h	Check key lock
A4h	Initialize typematic rate
A8h	Erase <ESC> prompt
AAh	Scan for <ESC> key stroke
ACh	Enter SETUP
A Eh	Clear Boot flag
B0h	Check for errors
B1h	Inform RomPilot about the end of POST (optional)
B2h	POST done - prepare to boot operating system
B4h	1 One short beep before boot
B5h	Terminate QuietBoot (optional)
B6h	Check password (optional)
B7h	Initialize ACPI BIOS and PPM Structures
B9h	Prepare Boot
BAh	Initialize SMBIOS
BCh	Clear parity checkers
BDh	Display MultiBoot menu
BEh	Clear screen (optional)
BFh	Check virus and backup reminders
C0h	Try to boot with INT 19
C1h	Initialize POST Error Manager (PEM)
C2h	Initialize error logging
C3h	Initialize error display function
C4h	Initialize system error flags
C6h	Console redirection init.
C7h	Unhook INT 10h if console redirection enabled
C8h	Force check (optional)
C9h	Extended ROM checksum (optional)
CDh	Reclaim console redirection vector
D2h	Unknown interrupt
D4h	Check Intel Branding string
D8h	Alert Standard Format initialization
D9h	Late init for IPMI
DEh	Log error if micro-code not updated properly

The following are for boot block in Flash ROM

POST Code	Description
E0h	Initialize the chipset
E1h	Initialize the bridge
E2h	Initialize the CPU
E3h	Initialize system timer
E4h	Initialize system I/O
E5h	Check force recovery boot
E6h	Checksum BIOS ROM
E7h	Go to BIOS
E8h	Set Huge Segment
E9h	Initialize Multi Processor
EAh	Initialize OEM special code
EBh	Initialize PIC and DMA
ECh	Initialize Memory type
EDh	Initialize Memory size
EEh	Shadow Boot Block
EFh	System memory test
F0h	Initialize interrupt vectors
F1h	Initialize Run Time Clock
F2h	Initialize video
F3h	Initialize System Management Manager
F4h	Output one beep
F5h	Clear Huge Segment
F6h	Boot to Mini DOS
F7h	Boot to Full DOS

If the BIOS detects errors on 2C, 2E, or 30 (base 512K RAM errors), it displays an additional word-bitmap (**xxxx**) to indicate the address line or bits that have failed. For example, "2C 0002" means address line 1 (bit one set) has failed. "2E 1020" means data bits 12 and 5 (bits 12 and 5 set) have failed in the lower 16 bits. The BIOS also sends the bitmap to the port-80 LED display. It first displays the checkpoint code, followed by a delay, the high-order byte, another delay, and then the loworder byte of the error. It repeats this sequence continuously.

Notes

Appendix C

Intel HostRAID Setup Guidelines

After all the hardware has been installed, you must first configure the Intel ICH9R SATA RAID* Settings before you install the Windows Operating System and other software drivers.

Note: If you do not wish to configure onboard SATA RAID functions, please go directly to Section C-2 and Appendix E for the Operating System & Other Software Installation.

C-1 Introduction to Serial ATA and Parallel ATA

To configure the SATA RAID functions, you must first use the Intel ICH9R SATA RAID Utility program to configure the RAID Level that you desire before installing the Windows XP/2000/2003 operating system and other software drivers. (The necessary drivers are all included on the Supermicro CD that came packaged with your motherboard.) **Note:** the current version of the ICH9R SATA RAID Utility can only support Windows XP/2000/2003 Operating Systems.

Serial ATA (SATA)

Serial ATA (SATA) is a physical storage interface that uses a single cable with a minimum of four wires to create a point-to-point connection between devices. It is a serial link, which supports transfer rates up to 3Gbps. Because the serial cables used in SATA are thinner than the traditional cables used in Parallel ATA (PATA), SATA systems have better airflow and can be installed in smaller chassis than Parallel ATA. In addition, the cables used in PATA are limited to a length of 40cm, while Serial ATA cables can be up to one meter in length. Overall, SATA provides better functionality than PATA.

Introduction to the Intel ICH9R Serial RAID Setup

Located in the South Bridge of the Intel 3210 Chipset, the I/O Controller Hub (ICH9R) provides the I/O subsystem with access to the rest of the system. It supports six Serial ATA (SATA) ports. The ICH9R supports the following SATA device configurations: Legacy mode and Native mode.

RAID Configurations

The following types of RAID configurations are supported:

RAID 0 (Data Striping): this writes data in parallel, interleaved ("striped") sections of two hard drives. Data transfer rate is doubled over using a single disk.

RAID 1 (Data Mirroring): an identical data image from one drive is copied to another drive. The second drive must be the same size or larger than the first drive.

RAID 10 (Striping & Mirroring): RAID 0 and 1 schemes are combined (without parity information) to get the benefits of both.

RAID 5: both data and parity information are striped and mirrored across three or more hard drives.

Intel Matrix Storage

The Intel Matrix Storage, supported by the ICH9R, allows the user to create RAID 0 and RAID1 set by using only two identical hard disk drives. The Intel Matrix Storage Technology creates two partitions on each hard disk drive and generate a virtual RAID0 and RAID1 sets. It also allows you the change the HDD partition size without any data.

Configuring BIOS settings for SATA RAID Functions (Native Mode)

1. Press the key during system bootup to enter the BIOS Setup Utility.

Note: If it is the first time powering on the system, we recommend you load the Optimized Default Settings. If you have already done so, please skip to Step 3.

2. Use the arrow keys to select the "Exit" Settings. Once in the "Exit" settings, Scroll down to select "Load Optimized Default Settings" and press the <Enter> key. Select "OK" to confirm the selection. Press the <Enter> key to load the default settings for the BIOS.

3. Use the arrow keys to select the "Main" section in BIOS.

4. Scroll down to "SATA Control Mode" and press the <Enter> key to select "Enhanced"

5. Scroll down to "SATA RAID Enabled" and press <Enter>. Then, select "Enabled." 6. Scroll down to "Exit". Select "Exit Saving Changes" from the "Exit" menu. Press the <Enter> key to save the changes and exit the BIOS.

7. Once you've exited the BIOS Utility, the system will re-boot.

8. During the system boot-up, press the <Ctrl> and <I> keys simultaneously to run the Intel RAID Configuration Utility when prompted by the following message: Press <Ctrl> <I> for Intel RAID Configuration Utility.

Using the Intel ICH9R SATA RAID Utility Program

1. Creating, Deleting and Resetting RAID Volumes:

- a. After the system exits from the BIOS Setup Utility, the system will automatically reboot. The following screen appears after Power-On Self Test.

```

RAID Volumes:
None defined.

Physical Disks:
Port Drive Model      Serial #              Size   Type/Status(Vol ID)
0   HDC WD2500SD-01K  WD-HMAL72034971      232.9GB Non-RAID Disk
1   HDC WD2500SD-01K  WD-HMAL72034599      232.9GB Non-RAID Disk
2   HDC WD2500JD-00F  WD-HMAEH1376109      232.9GB Non-RAID Disk
3   HDC WD2500JD-00F  WD-HMAEH1449527      232.9GB Non-RAID Disk

Press <CTRL-I> to enter Configuration Utility...

Adaptec SCSI BIOS v4.30.0
Copyright 2003 Adaptec, Inc. All Rights Reserved.

<<< Press <Ctrl><A> for SCSISelect(TM) Utility! >>>

Slot Ch ID LUN Vendor      Product              Size Bus Status
-----
04  A  10  0

```

- b. When you see the above screen, press the <Ctrl> and the <I> keys simultaneously to have the main menu of the SATA RAID Utility appear:

Note: All graphics and screen shots shown in the manual are for reference only. The screen shots shown in the manual do not imply Supernicro's endorsement or non-endorsement on any 3rd party's product. Your screens may or many not look exactly the same as the graphics shown in this manual.

Creating a RAID 0 Volume:

- a. Select "Create RAID Volume" from the main menu and press the <Enter> key. The following screen will appear:



- b. Specify a name for the RAID 0 set and press the <Tab> key or the <Enter> key to go to the next field. (You can use the <Esc> key to select the previous menu.)
- c. When RAID Level item is highlighted, press the <Up Arrow>, <Down Arrow> keys to select RAID 0 (Stripe) and hit <Enter>.
- d. When the Disks item is highlighted, press <Enter> to select the HDD to configure as RAID. The following pop-up screen (*See the note on Page C-3) displays:

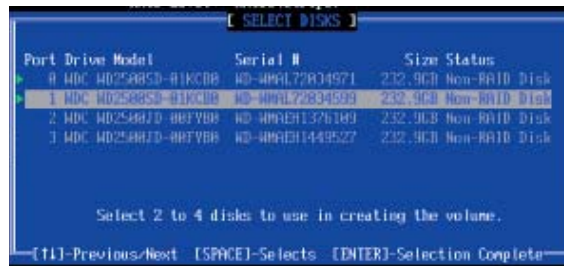

- e. Use the <Up Arrow>, <Down Arrow> keys to highlight a drive and press <Space> to select it. A triangle appears to confirm the selection of the drive.
- f. Use the <Up Arrow>, <Down Arrow> keys to select the stripe size, ranging from 4 KB to 128 KB for the RAID 0 array, and hit <Enter>. **Note:** For a server, please use a lower stripe size, and for a multimedia system, use a higher stripe size. The default stripe size is 128 KB.
- g. Press <Enter> when the Create Volume item is highlighted. A warning message displays.
- h. When asked "Are you sure you want to create this volume (Y/N)", press "Y" to create the RAID volume, or type "N" to go back to the Create Volume menu.

Creating a RAID 1 Volume:

- a. Select "Create RAID Volume" from the main menu and press the <Enter> key. The following screen will appear:

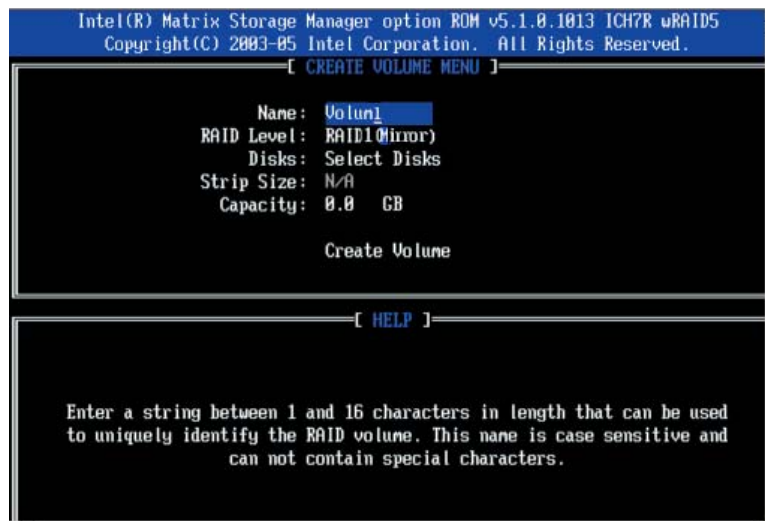

- b. Specify a name for the RAID 1 set and press the <Tab> key or the <Enter> key to go to the next field. (You can use the <Esc> key to select the previous menu.)
- c. When RAID Level item is highlighted, press the <Up Arrow>, <Down Arrow> keys to select RAID 1 (Mirror) and hit <Enter>.
- d. When the Capacity item is highlighted, enter your RAID volume capacity and hit <Enter>. The default setting is the maximum capacity allowed.
- e. Press <Enter> when the Create Volume item is highlighted. A warning message displays.
- f. When asked "Are you sure you want to create this volume (Y/N)", press "Y" to create the RAID volume, or type "N" to go back to the Create Volume menu.

Creating a RAID 10 (RAID 1+ RAID 0):

- a. Select "Create RAID Volume" from the main menu and press the <Enter> key. The following screen will appear:

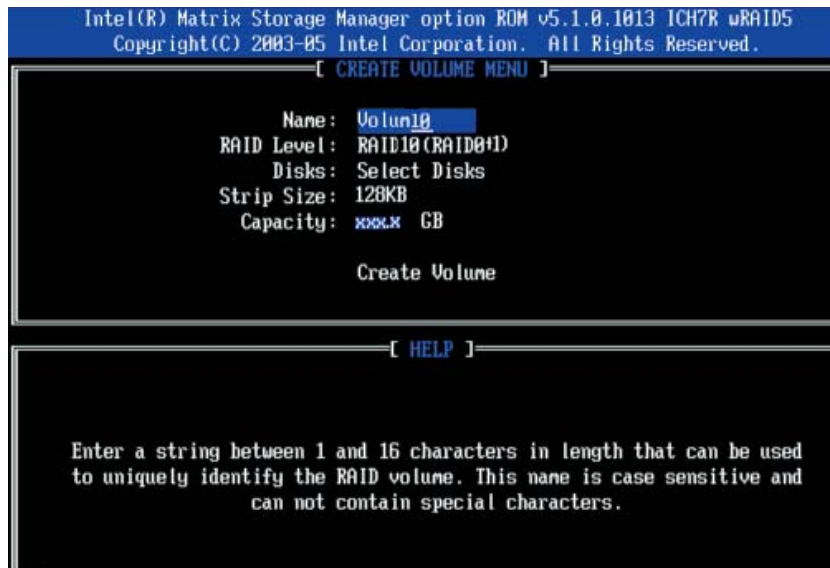

- b. Specify a name for the RAID 10 set and press <Enter>.
- c. When RAID Level item is highlighted, use the <Up Arrow>, <Down Arrow> keys to select RAID 10 (RAID1 + RAID0) and hit <Enter>.
- d. When the Stripe Size is highlighted, use the <Up Arrow>, <Down Arrow> keys to select the stripe size from 4 KB to 128 KB for your RAID 10 and hit <Enter>. The default setting is 6 4KB. (Note: For a server, please use a lower stripe size, and for a multimedia system, use a higher stripe size.)
- e. When the RAID Volume Capacity item is highlighted, enter your RAID volume capacity and hit <Enter>. The default setting is the maximum capacity allowed.
- f. Press <Enter> when the Create Volume item is highlighted. A warning message displays.
- g. When asked "Are you sure you want to create this volume (Y/N)", press "Y" to create the RAID volume, or type "N" to go back to the Create Volume menu.

Creating a RAID 5 Set (Parity):

- a. Select "Create RAID Volume" from the main menu and press the <Enter> key. The following screen will appear:

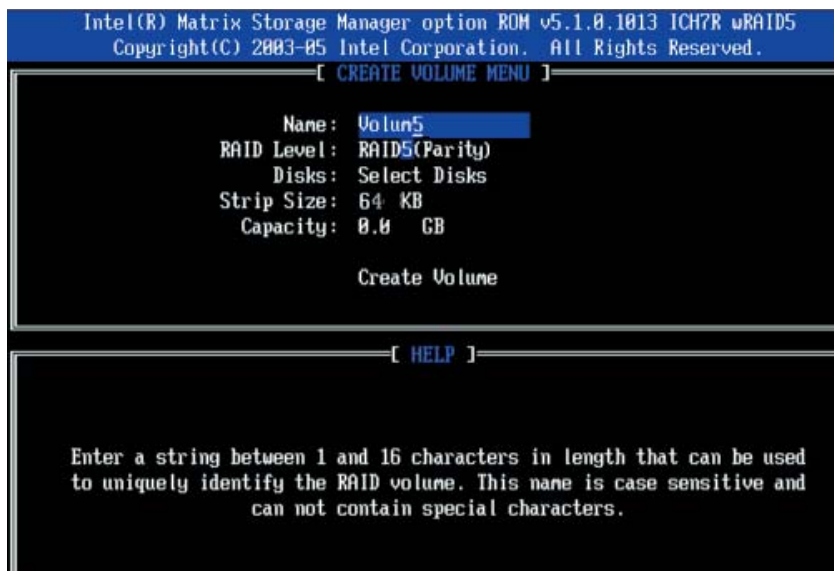

- b. Specify a name for the RAID 5 set and press <Enter>.
- c. When the Raid Level is highlighted, use the <Up Arrow>, <Down Arrow> keys to select RAID 5 (Parity) and hit <Enter>.
- d. When the Disk item is highlighted, press <Enter> to select the HDD to configure as RAID. The following pop-up screen (*See the note on Page C-3) displays:

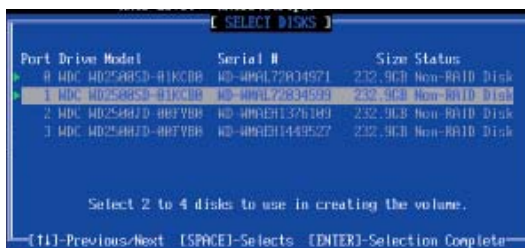

- e. Use the <Up Arrow>, <Down Arrow> keys to highlight a drive and press <Space> to select it. A triangle appears to confirm the selection of the drive.
- f. Use the <Up Arrow>, <Down Arrow> keys to select the stripe size, ranging from 4 KB to 128 KB for the RAID 5 array, and hit <Enter>. (Note: For a server, please use a lower stripe size, and for a multimedia system, use a higher stripe size. The default stripe size is 128 KB.)
- g. Enter your desired RAID volume capacity and press <Enter> when the capacity item is highlighted. The default setting is the maximum capacity allowed.
- h. Press Enter when the Create Volume item is highlighted. A warning message displays.
- i. When asked "Are you sure you want to create this volume (Y/N), press "Y" to create the RAID volume, or type "N" to go back to the Create Volume menu.

Deleting RAID Volume:



Warning: Be sure to back up your data before deleting a RAID set. You will lose all data on the disk drives when deleting a RAID set.)

- a. From the main menu, select item2-Delete RAID Volume, and press <Enter>.
- b. Use the <Up Arrow>, <Down Arrow> keys to select the RAID set you want to delete and press . A Warning message displays.
- c. When asked "Are you sure you want to delete this volume (Y/N), press "Y" to delete the RAID volume, or type "N" to go back to the Delete Volume menu.

Resetting to Non-RAID and Resetting a RAID HDD

Warning: Be cautious when you reset a RAID volume HDD to non-RAID or Resetting a RAID HDD. Resetting a RAID volume HDD or Resetting a RAID HDD will reformat the HDD and delete all internal RAID structure on the drive.

- a. From the main menu, select item3-Reset Disks to Non- RAID, and press <Enter>. The following screen will appear:

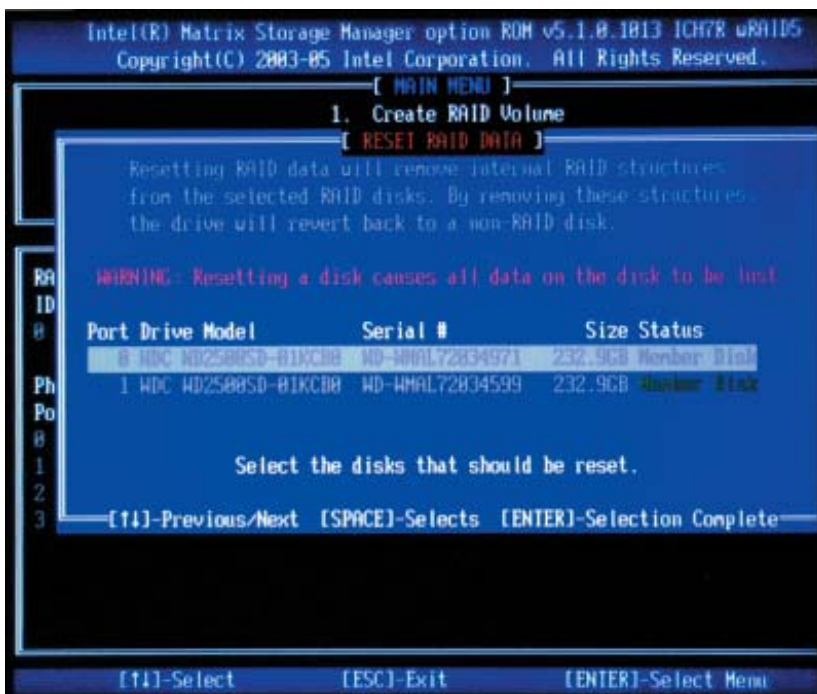

- b. Use the <Up Arrow>, <Down Arrow> keys to highlight the RAID set drive to reset and press <Space> to select.
- c. Press <Enter> to reset the RAID set drive. A Warning message displays.
- d. Press "Y" to reset the drive, or type "N" to go back to the main menu.

Exiting the Intel Matrix Storage Manager Utility:

- a. From the main menu, select item4-Exit, and press <Enter>. A warning message will appear.
- b. Press "Y" to reset the drive, or type "N" to go back to the main menu.

C-2 Installing Windows XP/2000/2003 for RAID Systems

Installing a New Operating System-the Windows XP/2000/2003 OS

- a. Insert Microsoft's Windows XP/2000/2003 Setup CD in the CD Drive, and the system will start booting up from CD.
- b. Press the <F6> key when the message-" Press F6 if you need to install a third party SCSI or RAID driver" displays.
- c. When the Windows XP/2000/2003 Setup screen appears, press "S" to specify additional device(s).
- d. Insert the driver diskette-"Intel AA RAID XP/2000/2003 Driver for ICH9R into Drive A: and press the <Enter> key.
- e. Select the Intel(R)82801GR/GH *SATA RAID Controller* from the list indicated in the XP/2000/2003 Setup Screen, and press the <Enter> key.
- f. Press the <Enter> key to continue the installation process. (If you need to specify any additional devices to be installed, do it at this time.) Once all devices are specified, press the <Enter> key to continue with the installation.
- g. From the Windows XP/2000/2003 Setup screen, press the <Enter> key. The XP/2000/2003 Setup will automatically load all device files and then, continue the Windows XP/2000/2003 installation.
- h. After the Windows XP/2000/2003 Installation is completed, the system will automatically reboot.
- i. Insert the Supermicro Setup CD that came with the package into the CD Drive during system reboot, and the main screen will appear.

Note: the current version of the ICH9R SATA RAID Utility can only support the Windows XP/2000/2003 Operating System.

Appendix D

System Specifications

Processors

Single or dual Intel® dual-core Xeon® 5400/5300/5200/5100 Sequence type processors at a front side (system) bus speed of 1333/1066 MHz

Note: Please refer to our web site for a complete listing of supported processors.

Chipset

Intel 5100/ICH9R chipset

BIOS

8 Mb Phoenix® Flash ROM

Memory Capacity

Six 240-pin DIMM slots that can support up to 32 GB of ECC DDR2-667/533 SDRAM

Note: 2-way interleaved memory - requires memory to be installed two modules at a time. See the memory section in Chapter 5 for details.

SAS Controller

Onboard LSI 1068 SAS controller for 8-port SAS (RAID 0, 1, 5 and 10 supported)

SATA Controller

On-chip (ICH9R) SATA controller for 6-port SATA (RAID 0, 1, 5 and 10 supported)

Drive Bays

Eight (8) hot-swap drive bays to house eight SAS or six SATA drives

Peripheral Drive Bays

One (1) 3.5" floppy drive

Two (2) 5.25" drive bays

Expansion Slots

One PCI-Express x16, one PCI-Express x4 (in a x16 slot), two 64-bit 133/100 MHz PCI-X, two PCI 33 MHz and an IPMI slot

Motherboard

7045A-C3: X7DCA-3 (Extended ATX form factor)

7045A-CT: X7DCA-i (Extended ATX form factor)

Dimensions (both): 12 x 13 in (305 x 330 mm)

Chassis

SC743TQ-865-SQ Form Factor: tower/4U rackmount

Dimensions (as tower): (WxHxD) 7 x 17.2 x 25.5 in. (178 x 437 x 648 mm)

Weight

Gross (Bare Bone): 64 lbs. (29.1 kg.)

System Cooling

Two (2) 8-cm low-noise chassis fans

One (1) 9-cm low-noise exhaust fan

Two (2) active CPU heat sinks

System Input Requirements

AC Input Voltage: 100-240V AC auto-range

Rated Input Current: 100 (12A) - 240V (6A)

Rated Input Frequency: 50 to 60 Hz

PFC Power Supply

Rated Output Power: 865W (Part# PWS-865-PQ)

Rated Output Voltages: +3.3V (30A), +5V (30A), +12V_{ALL} (70A), +5Vsb (6.5A)

Operating Environment

Operating Temperature: 10° to 35° C (50° to 95° F)

Non-operating Temperature: -40° to 70° C (-40° to 158° F)

Operating Relative Humidity: 8% to 90% (non-condensing)

Non-operating Relative Humidity: 5 to 95% (non-condensing)

Regulatory Compliance

Electromagnetic Emissions:

FCC Class B, EN 55022 Class B, EN 61000-3-2/-3-3, CISPR 22 Class B

Electromagnetic Immunity:

EN 55024/CISPR 24, (EN 61000-4-2, EN 61000-4-3, EN 61000-4-4,
EN 61000-4-5, EN 61000-4-6, EN 61000-4-8, EN 61000-4-11)

Safety:

EN 60950/IEC 60950-Compliant, UL Listed (USA), CUL Listed (Canada), TUV
Certified (Germany), CE Marking (Europe)

California Best Management Practices Regulations for Perchlorate Materials:

This Perchlorate warning applies only to products containing CR (Manganese Dioxide) Lithium coin cells. "Perchlorate Material-special handling may apply. See www.dtsc.ca.gov/hazardouswaste/perchlorate"

Notes