

Panasonic®

Operating Instructions

Microwave Oven
Models NN-S562
NN-S592



This manual contains Safety Instructions, Operating Instructions and Maintenance of the oven.
Before operating this oven, please read these instructions completely.

Antes de operar este producto, lea este instructivo en su totalidad.

El manual de instrucciones en español puede ser encontrada en la páginas 22-29
(Spanish Operating Instructions can be found on pages 22-29)

For assistance, please call :1-800-211-PANA(7262)
or send e-mail to :consumerproducts@panasonic.com
or visit us at www.panasonic.com

(U.S.A)

For assistance, please call : 787-750-4300
or visit us at www.panasonicpr.com

(Puerto Rico)

Thank you for purchasing a Panasonic Microwave Oven.

PRECAUTIONS TO AVOID POSSIBLE EXPOSURE TO EXCESSIVE MICROWAVE ENERGY

- (a) Do not attempt to operate this oven with the door open since open-door operation can result in harmful exposure to microwave energy. It is important not to defeat or tamper with the safety interlocks. Under normal conditions oven will not operate with door open.
- (b) Do not place any object between the oven front face and the door or allow soil or cleaner residue to accumulate on sealing surfaces.
- (c) Do not operate the oven if it is damaged. It is particularly important that the oven door close properly and that there is no damage to the:
 - (1) door (bent),
 - (2) hinges and latches (broken or loosened),
 - (3) door seals and sealing surfaces.
- (d) The oven should not be adjusted or repaired by anyone except properly qualified service personnel.

Technical Specifications

| | NN-S562/NN-S592 |
|--|--|
| Power Source | 120 V 60 Hz |
| Power Consumption: | 11.5 Amps, 1,320 W |
| Output:* | 1,300 W |
| Outside Dimensions (H x W x D): | 11 ⁷ / ₈ " x 20 ³ / ₈ " x 15 ⁷ / ₈ " (301 x 518 x 404 mm) |
| Oven Cavity Dimensions (H x W x D): | 8 ⁷ / ₈ " x 14 ³ / ₄ " x 15 ³ / ₁₆ " (225 x 375 x 386 mm) |
| Operating Frequency: | 2,450 MHz |
| Uncrated Weight: | Approx. 23 lbs. (10.5 kg) |

*IEC 705-88 Test procedure

Specifications subject to change without notice.

The serial number of this product may be found on the back side of the oven. You should note the model number and the serial number of this oven in the space provided and retain this book as a permanent record of your purchase for future reference.

Model No. _____

Serial No. _____

Date of Purchase _____

CONTENTS

Before Operating

| | |
|---|--------------------|
| Precautions | Inside Front Cover |
| Important Safety Instructions | 2-3 |
| Installation and Grounding Instructions | 4 |
| Safety Precautions | 5 |
| Cookware and Utensil Guide | 6 |
| Feature Diagram | 7 |
| Control Panel | 7 |

Operation

| | |
|--|------------|
| Let's Start to Use Your Oven | 8 |
| Clock Setting | 8 |
| To Use Child Safety Lock | 9 |
| To Use More/Less Pad | 9 |
| To Use Popcorn Pad | 9 |
| To Use Bacon Pad | 10 |
| To Reheat using Power & Time Setting | 8 |
| Sensor Reheat | 12 |
| To Defrost using Power & Time Setting | 8 |
| Inverter Turbo Defrost | 10-11 |
| To Cook using Power & Time Setting | 8 |
| Sensor Cook | 12-14 |
| Quick Min Function | 10 |
| Timer Setting (Kitchen Timer / Stand Time / Delay Start) | 15 |
| Microwave Shortcuts | 16 |
| Food Characteristics | 17 |
| Cooking Techniques | 17-18 |
| Quick Guide to Operation | Back Cover |

Maintenance

| | |
|--|--------------------|
| Technical Specifications | Inside Front Cover |
| Care of Your Microwave Oven | 19 |
| To Order Accessories, Books, etc. | 19 |
| Before Requesting Service | 20 |
| Limited Warranty & Customer Services Directory | 21 |

Manual de instrucciones (Spanish Operating Instructions)

| | |
|--|-------|
| Precauciones | 22 |
| Instrucciones de Seguridad | 22-23 |
| Instrucciones para Conexión a Tierra | 23 |
| Instrucciones de Instalación | 24 |
| Sugerencias Útiles | 25 |
| Panel de Control | 26 |
| Procedimientos de Operación | 27-28 |
| Guía Rápida de Operación | 29 |

For assistance, PLEASE CALL 1-800-211-PANA (7262)

IMPORTANT SAFETY INSTRUCTIONS

Your microwave oven is a cooking device and you should use as much care as you use with a stove or any other cooking device. When using this electric appliance, basic safety precautions should be followed, including the following:

WARNING—To reduce the risk of burns, electric shock, fire, injury to persons, or exposure to excessive microwave energy:

1. Read all instructions before using the appliance.
2. Read and follow the specific **“PRECAUTIONS TO AVOID POSSIBLE EXPOSURE TO EXCESSIVE MICROWAVE ENERGY,”** found on the inside front cover.
3. This appliance must be grounded. Connect only to properly grounded outlet. See **“GROUNDING INSTRUCTIONS”** found on page 4.
4. Install or locate this appliance only in accordance with the installation instructions found on page 4.
5. Do not cover or block any openings on this appliance.
6. Do not store or use this appliance outdoors.
Do not use this product near water—for example, near a kitchen sink, in a wet basement, or near a swimming pool, and the like.
7. Use this appliance only for its intended use as described in this manual. **DO NOT** use corrosive chemicals, vapors, or non-food products in this appliance. This type of oven is specifically designed to heat, or cook. It is not designed for industrial or laboratory use. The use of corrosive chemicals in heating or cleaning will damage the appliance and may result in radiation leaks.
8. When cleaning surfaces of door and oven that come together on closing the door, use only mild, non-abrasive soaps or detergents applied with a sponge or soft cloth.
9. Do not allow children to use this appliance, unless closely supervised by an adult.
10. Do not operate this appliance if it has a damaged cord or plug, if it is not working properly, or if it has been damaged or dropped.
11. Do not immerse cord or plug in water.
12. Keep cord away from heated surfaces.
13. Do not let cord hang over edge of a table or counter.
14. This appliance should be serviced only by qualified service personnel. Contact the nearest authorized servicenter for examination, repair or adjustment.
15. Some products such as whole eggs, narrow neck bottles and sealed containers—for example, closed glass jars—may explode and should not be heated in this oven.
16. To reduce the risk of fire in the oven cavity:
 - (a) Do not overcook food. Carefully attend appliance if paper, plastic, or other combustible materials are placed inside the oven to facilitate cooking.
 - (b) Remove wire twist-ties from paper or plastic bags before placing bag in oven.
 - (c) **If materials inside the oven should ignite, keep oven door closed, turn oven off, and disconnect the power cord, or shut off power at the fuse or circuit breaker panel.**
 - (d) Do not use the cavity for storage purposes. Do not leave paper products, cooking utensils, or food in the cavity when not in use.
17. Liquids, such as water, coffee, or tea are able to be overheated beyond the boiling point without appearing to be boiling due to surface tension of the liquid. Visible bubbling or boiling when the container is removed from the microwave oven is not always present. **THIS COULD RESULT IN VERY HOT LIQUIDS SUDDENLY BOILING OVER WHEN A SPOON OR OTHER UTENSIL IS INSERTED INTO THE LIQUID.** To reduce the risk of injury to persons:
 - (a) Do not overheat the liquid.
 - (b) Stir the liquid both before and halfway through heating it.
 - (c) Do not use straight-sided containers with narrow necks.
 - (d) After heating, allow the container to stand in the microwave oven for a short time before removing the container.
 - (e) Use extreme care when inserting a spoon or other utensil into the container.

SAVE THESE INSTRUCTIONS

For proper use of your oven read remaining safety cautions and operating instructions.

IMPORTANT SAFETY INSTRUCTIONS

General Use

1. **DO NOT** tamper with or make any adjustments or repairs to door, Control Panel housing, safety interlock switches or any other part of the oven. **DO NOT** remove outer panel from oven. Repairs must only be done by a qualified service person.
2. **DO NOT** operate the oven empty. The microwave energy will reflect continuously throughout the oven causing overheating, if food or water is not present to absorb energy. This could damage the oven and result in the risk of a fire.
3. **DO NOT** dry clothes, newspapers or other materials in oven, or use newspapers or paper bags for cooking. Fire could result.
4. **DO NOT** use recycled paper products unless the paper product is labeled as safe for microwave oven use. Recycled paper products may contain impurities which may cause sparks, and result in fires when used.
5. **DO NOT** hit or strike Control Panel. Damage to controls may occur. Fire could result.
6. **POT HOLDERS** should always be used when removing items from the oven. Heat is transferred from the **HOT** food to the cooking container and from the cooking container to the Glass Tray. The Glass Tray can be very **HOT** after removing the cooking container from the oven.
7. **DO NOT** store flammable materials next to, on top of, or in the oven. These could be fire hazards.

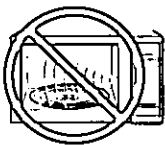
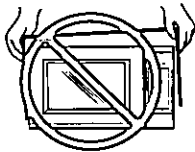

Glass Tray

1. **DO NOT** operate the oven without Roller Ring and Glass Tray in place.
2. **DO NOT** operate the oven without the Glass Tray fully engaged on the drive hub. Improper cooking or damage to the oven could result. Verify that the Glass Tray is properly engaged and rotating by observing its rotation when you press **Start**.
3. Only use the Glass Tray specifically designed for this oven. Do not substitute any other glass tray.
4. If the Glass Tray is hot, allow to cool before cleaning or placing in water.
5. **DO NOT** cook directly on the Glass Tray. Always place food in a microwave-safe dish, or on a rack set in a microwave-safe dish.
6. If food or utensil on the Glass Tray touches oven walls, causing the tray to stop moving, the tray will automatically rotate in the opposite direction. This is normal.
7. Glass Tray can turn in either direction.

Roller Ring

1. Roller Ring and oven floor should be cleaned frequently to prevent excessive noise.
2. Roller Ring must always be used for cooking along with Glass Tray.
3. Always replace Roller Ring and Glass Tray in their proper positions.

INSTALLATION AND GROUNDING INSTRUCTIONS

Examine Your Oven

Unpack oven, remove all packing material and examine the oven for any damages such as dents, broken door latches or cracks in the door. Notify dealer immediately if oven is damaged. **DO NOT** install if oven is damaged.

Placement of Oven

- Oven must be placed on a flat, stable surface. For proper operation, the oven must have sufficient air flow. Allow 3-inches (7.6 cm) of space on both sides of the oven and 1-inch (2.5 cm) of space of space on top of oven.
 - DO NOT** block air vents. If they are blocked during operation, the oven may be overheated and damaged. When using any cloth over the oven, the air intake and exhaust should not be blocked. Also should allow space on back and both sides of oven properly.
 - DO NOT** place oven near a hot, damp surface such as a gas or electric range, or dishwasher.
 - DO NOT** operate oven when room humidity is too high.
- This oven was manufactured for household use only.

Grounding Instructions

This appliance must be grounded. In the event of an electrical short circuit, grounding reduces the risk of electric shock by providing an escape wire for the electric current. This appliance is equipped with a cord having a grounding wire with a grounding plug. The plug must be plugged into an outlet that is properly installed and grounded.

WARNING—Improper use of the grounding plug can result in a risk of electric shock.

Consult a qualified electrician or service person if the grounding instructions are not completely understood, or if doubt exists as to whether the appliance is properly grounded. If it is necessary to use an extension cord, use only a three wire extension cord that has a three blade grounding plug, and a three slot receptacle that will accept the plug on the appliance. The marked rating of the extension cord should be equal to or greater than the electrical rating of the appliance.

Power Supply

- A short power-supply cord is provided to reduce the risks resulting from becoming entangled in or tripping over a longer cord.
- Longer cord sets or extension cords are available and may be used if care is exercised in their use.
- If a long cord or extension cord is used, (1) the marked electrical rating of the cord set or extension cord should be at least as great as the electrical rating of the appliance, (2) the extension cord must be a grounding-type 3-wire cord, and (3) the longer cord should be arranged so that it will not drape over the counter top or tabletop where it can be pulled on by children or tripped over accidentally.

Wiring Requirements

- The oven must be operated on a **SEPARATE CIRCUIT**. No other appliance should share the circuit with the microwave oven. If it does, the branch circuit fuse may blow, the circuit breaker may trip, or the food may cook slower than the times recommended in this manual.
- The **VOLTAGE** used must be the same as specified on this microwave oven (120 V, 60 Hz). Using a higher voltage is dangerous and may result in a fire or another incident causing oven damage. Using a lower voltage will cause slow cooking. Panasonic is **NOT** responsible for any damages resulting from the use of the oven with any voltage other than specified.
- The oven must be plugged into at least a **20 AMP, 120 VOLT, 60 Hz GROUNDED OUTLET**. Where a standard two-prong outlet is encountered, it is the personal responsibility and obligation of the consumer to have it replaced with a properly grounded three-prong outlet.



TV / Radio Interference

- Operation of the microwave oven may cause interference to your radio, TV or similar equipment.
- When there is interference, it may be reduced or eliminated by taking the following measures:
 - Clean door and sealing surfaces of the oven. (See Care of Your Microwave Oven)
 - Place the radio, TV, etc. away from the microwave oven as far as possible.
 - Use a properly installed antenna to obtain stronger signal reception.

Safety Precautions

Follow These Safety Precautions When Cooking in Your Oven

IMPORTANT

Proper cooking depends upon the power, the time set and quantity of food. If you use a smaller portion than recommended and cook at the time for the recommended portion, fire could result.

1) HOME CANNING / DRYING FOODS / SMALL QUANTITIES OF FOODS

- Do not use your oven for home canning, your oven cannot maintain the food at the proper canning temperature. Improperly canned food may spoil and be dangerous to consume.
- Do not dry meats, herbs, fruits or vegetables in your oven. Small quantities of food or foods with low moisture content can dry out, scorch or catch on fire if overheated.

2) POPCORN

Popcorn may be popped in a microwave oven corn popper. Microwave popcorn which pops in its own package is also available. Follow popcorn manufacturers' directions and use a brand suitable for the wattage of your microwave oven.

CAUTION: When using pre-packaged microwave popcorn, follow recommended package instructions. Check package weight before using the *Popcorn pad* (see *Popcorn Pad* section). Set the oven for the weight of the popcorn package. If these instructions are not followed, the popcorn may not pop adequately or may ignite and cause a fire. Never leave oven unattended when popping popcorn. Allow the popcorn bag to cool before opening, always open the bag away from your face and body to prevent steam burns.

3) DEEP FAT FRYING

- Do not attempt to deep fat fry in your microwave oven. Cooking oils may burst into flames and may cause damage to the oven and perhaps result in burns. Microwave utensils may not be able to withstand the temperature of the hot oil, and could shatter or melt.

4) FOODS WITH NONPOROUS SKINS

- Potatoes, apples, egg yolks, whole eggs, whole squash and sausages are examples of foods with nonporous skins. These types of foods must be pierced before microwave cooking to prevent their bursting.
- Use fresh potatoes for baking and cook until just done. Use recommended weights for programmed cooking. Overcooking causes dehydration and may result in a fire.

5) GLASS TRAY / COOKING UTENSILS / FOIL

- Cooking utensils get hot during microwaving. Heat is transferred from the HOT food to the

container and the Glass Tray. Use potholders when removing utensils from the oven or when removing lids or plastic wrap covers from cooking utensils, to avoid burns.

- The Glass Tray will get hot during cooking. It should be allowed to cool before handling or before paper products, such as paper plates or microwave popcorn bags, are placed in the oven for microwave cooking.
- When using foil, skewers, warming rack or utensils made of metal in the oven, allow at least 1-inch (2.5 cm) of space between metal material and interior oven walls. If arcing occurs (sparking), remove metal material (skewers etc.) and/or transfer to a non-metallic container.
- Dishes with metallic trim should not be used, as arcing may occur.
- If an entree is heated in a foil tray, maintain at least 1-inch (2.5 cm) spacing from the oven walls.

6) PAPER TOWELS / CLOTHS

- DO NOT use paper towels or cloths which contain a synthetic fiber woven into them. The synthetic fiber may cause the towel to ignite. Use paper toweling under supervision.

7) BROWNING DISHES / OVEN COOKING BAGS

- Browning dishes or grills are designed for microwave cooking only. Always follow instructions provided by the manufacturer. DO NOT preheat browning dish more than 6 minutes.
- If an oven cooking bag is used for microwave cooking, prepare according to package directions. DO NOT use a wire twist-tie to close bag, instead use plastic ties, cotton string or a strip cut from the open end of the bag.

8) THERMOMETERS

- DO NOT use a conventional meat thermometer in your oven. Arcing may occur. Microwave-safe thermometers are available for both meat and candy.

9) BABY FORMULA / FOOD

- DO NOT heat baby formula or food in the microwave oven. The glass jar or surface of the food may appear warm while the interior can be so hot as to burn the infant's mouth and esophagus.

10) REHEATING PASTRY PRODUCTS

- When reheating pastry products, check temperatures of any fillings before eating. Some foods have fillings which heat faster and can be extremely hot, while the surface remains warm to the touch (ex. Jelly Donuts).

11) GENERAL OVEN USAGE GUIDELINES

- DO NOT use the oven for any reason other than the preparation of food.
- DO NOT leave oven unattended while in use.

Cookware and Utensil Guide

| ITEM | MICROWAVE | COMMENTS |
|--|------------------------|---|
| Aluminum Foil | Yes for Shielding only | Small strips of foil can be molded around thin parts of meat or poultry to prevent overcooking. Arcing can occur if foil is too close to oven wall or if too much foil is used. |
| Browning Dish | Yes | Browning dishes are designed for microwave cooking only. Check browning dish information for instructions and heating chart. Do not preheat for more than 6 minutes. |
| Brown paper bags | No | May cause a fire in the oven. |
| Dinnerware Labeled "Microwave-Safe" | Yes | Check manufacturers' use and care directions for use in microwave heating. Some dinnerware may state on the back of the dish, "Oven-Microwave Safe". |
| Other Dinnerware | ? | Use CONTAINER TEST below. |
| Disposable polyester Paperboard Dishes | Yes | Some frozen foods are packaged in these dishes. Can be purchased in grocery stores. |
| Fast Food Carton with Metal Handle | No | Metal handle may cause arcing. |
| Frozen Dinner Tray Metal | Yes | Frozen dinners may be heated in foil tray, if tray is less than 7/4-in. (2 cm) high. Place foil tray in center of oven. Leave at least 1-in. (2.5 cm) space between foil tray and oven walls. Heat only 1 foil tray in the oven at a time. For containers more than 7/4-inch (2 cm) deep, remove food and place in a similar size microwave-safe container. |
| Microwave-safe | Yes | |
| Glass Jars | Yes, use caution | Remove lid. Heat food until just warm, not HOT. Most glass jars are not heat resistant. Do not use for cooking. |
| Glassware Heat Resistant Oven Glassware & Ceramics | Yes | Ideal for microwave cooking and browning. (See CONTAINER TEST below) |
| Metal Bakeware | No | Not recommended for use in microwave ovens. |
| Metal Twist-Ties | No | May cause arcing which could cause a fire in the oven. |
| Oven Cooking Bag | Yes | Follow manufacturers' directions. Close bag with the nylon tie provided, a strip cut from the end of the bag, or a piece of cotton string. Do not close with metal twist-tie. Make six 1/2-in. (1 cm) slits near the closure. |
| Paper Plates & Cups | Yes | Use to warm cooked foods, and to cook foods that require short cooking times such as hot dogs. |
| Paper Towels & Napkins | Yes | Use to warm rolls and sandwiches by microwave. |
| Parchment Paper | Yes | Use as a cover to prevent spattering. Safe for use in microwave, microwave/convection and conventional ovens. |
| Plastic Microwave-Safe Cookware Reheat & Storage | Yes | Should be labeled, "Suitable for Microwave Heating." Check manufacturers' directions for recommended uses. Some microwave-safe plastic dishes are not suitable for cooking foods with high fat or sugar content. The heat from hot food may cause the plastic to warp. |
| Melamine | No | |
| Plastic Foam Cups | Yes, use caution | Plastic foam will melt if foods reach a high temperature. Use to bring foods to a low serving temperature. |
| Plastic Wrap | Yes | Use to cover food during cooking to retain moisture and prevent spattering. Should be labeled "Suitable for Microwave Heating". Check package directions. |
| Straw, Wicker, Wood | Yes | Use only for short term reheating and to bring food to a low serving temperature. |
| Thermometers Microwave-safe, only | Yes | Use only microwave-safe meat and candy thermometers. Not suitable for use in microwave oven, will cause sparks and get hot. |
| Conventional | No | |
| Wax paper | Yes | Use as a cover to prevent spattering and to retain moisture. |

CONTAINER TEST

TO TEST A CONTAINER FOR SAFE MICROWAVE OVEN USE: Fill a 1-cup glass measure with water and place it in the microwave oven along with the container to be tested; **heat one (1) minute at P10 (HIGH)**. If the container is microwave oven-safe (transparent to microwave energy), the container should remain comfortably cool and the water should be hot. If the container is hot, it has absorbed some microwave energy and should NOT be used. This test cannot be used for plastic containers.

Feature Diagram

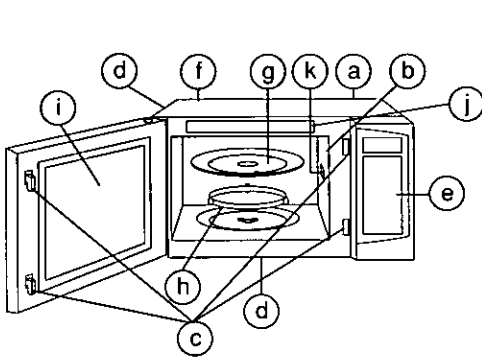

- (a) External Air Vents
- (b) Internal Air Vents
- (c) Door Safety Lock System
- (d) Exhaust Air Vents
- (e) Control Panel
- (f) Identification Plate
- (g) Glass Tray
- (h) Roller Ring
- (i) Heat/Vapor Barrier Film
(do not remove)
- (j) Menu Label
- (k) Cover (do not remove)

Oven Light:

Oven Light turns on only while cooking and will not turn on when oven door is opened.

Control Panel

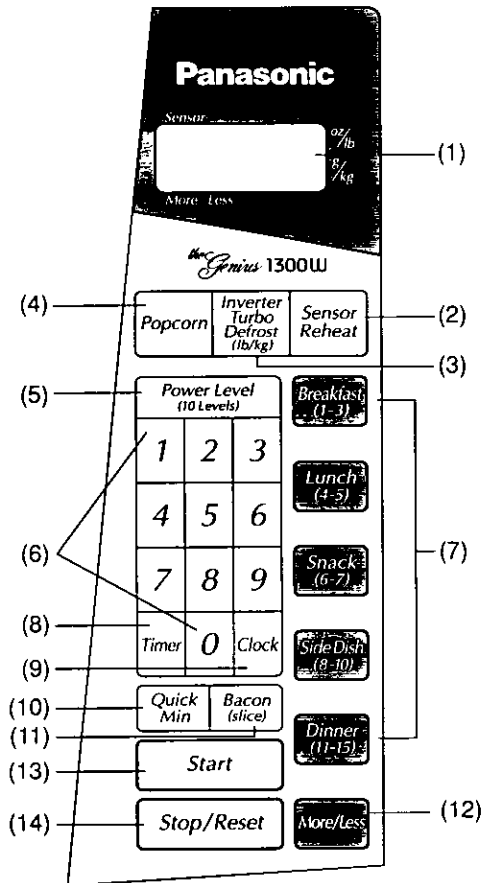

- (1) Display Window
- (2) Sensor Reheat Pad (page 12)
- (3) Inverter Turbo Defrost Pad
(page 10)
- (4) Popcorn Pad (page 9)
- (5) Power Level Pad (page 8)
- (6) Number Pads
- (7) Sensor Cook Pads
(page 12)
- (8) Timer Pad (page 15)
- (9) Clock Pad (pages 8)
- (10) Quick Min Pad (page 10)
- (11) Bacon Pad (page 10)
- (12) More/Less Pad (page 9, 12)

(13) **Start Pad**
One tap allows oven to begin functioning. If door is opened or **Stop/Reset** Pad is pressed once during oven operation, **Start** Pad must be pressed again to restart oven.

(14) **Stop/Reset Pad**
Before cooking: One tap clears your instruction.
During cooking: One tap temporarily stops the cooking process. Another tap cancels all your instructions and time of day or colon appears on the **Display Window**.

Beep Sound:
When a pad is pressed correctly, a beep will be heard.
If a pad is pressed and no beep is heard, the unit did not or cannot accept the instruction. The oven will beep twice between programmed stages. At the end of any complete program, the oven will beep 5 times.

Let's Start to Use Your Oven!

1. Plug into a properly grounded electrical outlet.



Display Window

The oven automatically displays weights in imperial (oz/lb).

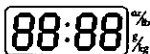

2. If you wish to use metric (g/kg):

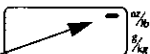
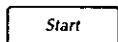

Press **Start** to convert to metric. Verify your selection on the **Display Window**.



3. **Stop/Reset** Colon appears on **Display Window**.
Press

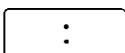

Now, enjoy cooking with your Panasonic microwave.

Clock Setting

The oven will operate without setting the clock.

Example: To set 11:25 a.m. or p.m.

| | | |
|----|--|--|
| 1. | | <ul style="list-style-type: none"> • Press once. ▶ Colon flashes. |
| 2. | | <ul style="list-style-type: none"> • Enter time of day using the number pads. ▶ Time appears on the Display Window; colon continues flashing. |
| 3. | | <ul style="list-style-type: none"> • Press. ▶ Colon stops flashing; time of day is entered. |

NOTES:

1. To reset the clock, repeat steps 1- 3.
2. The clock will retain the time of day as long as the oven is plugged in and electricity is supplied.
3. Clock is a 12 hour display.
4. Oven will not operate while colon is flashing.

Power & Time Setting

This feature allows you to manually set the power and time for microwave cooking.

Example: To cook at P 6 (MEDIUM) Power for 1 minute 30 seconds

| | | |
|----|--------------------|--|
| 1. | Press 5 times. | <ul style="list-style-type: none"> • Select Power Level. (according to the chart below) |
| 2. | | <ul style="list-style-type: none"> • Set Cooking Time using number pads. |
| 3. | | <ul style="list-style-type: none"> • Press. ▶ Cooking will start. The time on the Display Window will count down. |

| Press | Power Level |
|----------|--------------------------|
| once | P10 (HIGH) |
| twice | P 9 |
| 3 times | P 8 |
| 4 times | P 7 (MEDIUM-HIGH) |
| 5 times | P 6 (MEDIUM) |
| 6 times | P 5 |
| 7 times | P 4 |
| 8 times | P 3 (MEDIUM-LOW)/DEFROST |
| 9 times | P 2 |
| 10 times | P 1 (LOW) |

NOTES:

1. For more than one stage cooking, repeat steps 1 and 2 for each stage of cooking before pressing **Start** Pad. The maximum number of stages for cooking is 5 stages.
2. When selecting P10 (HIGH) power for the first stage, you may begin at step 2.
3. Two beeps will sound between each stage of programming. Five beeps will sound at the end of the entire sequence.
4. When selecting P10 (HIGH) power, the maximum programmable time is 30 minutes. For other power levels, the maximum time is 99 minutes and 99 seconds.
5. For reheating, use P10 (HIGH) for liquids, P7 (MEDIUM-HIGH) for most foods and P6 (MEDIUM) for dense foods.
6. For defrosting, use P3 (MEDIUM-LOW).

To Use Child Safety Lock

This feature prevents the electronic operation of the oven until cancelled. It does not lock the door.

To Set:



Press 3 times.

- "Child" appears on the Display Window.
- ▶ "Child" continues to be displayed until Child Lock is cancelled. Keypads may be pressed but the microwave will not start.

To Cancel:



Press 3 times.

- The Display Window will return to color or time of day when Child Lock has been cancelled.

To Use More/Less Pad

For Popcorn:

When using Popcorn pad, maybe the weight is not the same as offered. By using the More/Less pad, the programs can be adjusted to cook food for a longer or shorter time or a heavier or lighter weight.

- 1 tap = More Cooking
- 2 taps = More+ Cooking
- 3 taps = Less Cooking
- 4 taps = Less- Cooking
- 5 taps = original setting

For Sensor Reheat/Cook:

Preferences for food doneness vary with each individual. After having used the Sensor Cook feature a few times, you may decide you would prefer your food cooked to a different doneness.

- 1 tap = More Cooking
- 2 taps = Less Cooking
- 3 taps = original setting

Press More/Less pad before pressing Start.

To Use Popcorn Pad

Example: To heat 1.75 oz. of Popcorn

1.



Press once

- Set the desired weight of prepackaged microwave popcorn.

| Press | Weight |
|---------|----------------|
| once | 1.75 oz. (50g) |
| twice | 2.65 oz. (75g) |
| 3 times | 2.85 oz. (80g) |
| 4 times | 3.0 oz. (85g) |
| 5 times | 3.5 oz. (99g) |

2.



Optional.

3.



- Press **Start** Pad.
- ▶ After several seconds, cooking time appears on the **Display Window** and begins to count down.



NOTES ON POPCORN PAD:

1. Use prepackaged **room temperature** microwave popcorn. Read manufacturers' instructions.
2. Place bag in oven according to manufacturers' directions.
3. Pop only one bag at a time.
4. After popping, allow the contents of the bag to cool for a few minutes before opening. Open bag carefully away from face and body because popcorn and steam are extremely hot.
5. Do not reheat unpopped kernels or reuse bag.
6. **NEVER** leave oven unattended when popping popcorn. Stop the oven when popping slows to 2 to 3 seconds between pops. Overcooking may cause scorching.
7. With the many varieties of microwave popcorn available in the market place, it may be necessary for you to move the popcorn container to the outer edge of the glass tray to obtain the best cooking results.

REMARK: When popping multiple bags one right after the other, the cooking times may vary slightly. This does not affect the popcorn results.

To Use Bacon Pad

Example: To cook 4 slices of Bacon

| 1.  Press once. | • Set the desired number of slices. | | | | | | | | | | |
|---|---|---|--------|------|---|-------|--|---------|---|---------|---|
| | <table border="1"> <tr> <th>Press</th> <th>Slices</th> </tr> <tr> <td>once</td> <td>4 slices (3.2 - 4 oz.) (90 - 110 g)</td> </tr> <tr> <td>twice</td> <td>6 slices (4.8 - 5.8 oz.) (135 - 165 g)</td> </tr> <tr> <td>3 times</td> <td>10 slices (8.1 - 9.5 oz.) (230 - 270 g)</td> </tr> <tr> <td>4 times</td> <td>14 slices (11.6 - 13 oz.) (330 - 370 g)</td> </tr> </table> | Press | Slices | once | 4 slices (3.2 - 4 oz.) (90 - 110 g) | twice | 6 slices (4.8 - 5.8 oz.) (135 - 165 g) | 3 times | 10 slices (8.1 - 9.5 oz.) (230 - 270 g) | 4 times | 14 slices (11.6 - 13 oz.) (330 - 370 g) |
| | Press | Slices | | | | | | | | | |
| | once | 4 slices (3.2 - 4 oz.) (90 - 110 g) | | | | | | | | | |
| twice | 6 slices (4.8 - 5.8 oz.) (135 - 165 g) | | | | | | | | | | |
| 3 times | 10 slices (8.1 - 9.5 oz.) (230 - 270 g) | | | | | | | | | | |
| 4 times | 14 slices (11.6 - 13 oz.) (330 - 370 g) | | | | | | | | | | |
| 2.  | • Press Start Pad . ► Cooking time appears on the Display Window and begins to count down. | | | | | | | | | | |



NOTES ON BACON PAD:

- For best results, place bacon on ridged (Bacon) dish. This keeps it away from the grease and helps it to crisp.
- To absorb grease spatters, cover with paper towels.
- If bacon is not cooked to your liking, continue to heat by manually adding more time.

Quick Min Function

This feature allows you to set and/or add cooking times easily in multiples of one minute.

To Set Cooking Time:

| | |
|--|---|
| 1.  | • Set cooking time (up to 10) Power Level is P10. |
| 2.  | • Press Start Pad . ► Cooking begins and Display Window counts down. At the end of cooking, 5 beeps sound and colon or time of day appears. |

NOTE:



- You can use other power levels. Select desired power level before setting cooking time.
- After setting the time by **Quick Min** Pad, you cannot use Number Pads, and vice versa.
- Press **Quick Min** Pad to add more time during cooking. To verify the additional cooking time, check the **Display Window**.

Inverter Turbo Defrost

This feature allows you to defrost meat, poultry and seafood simply by entering the weight.

Example: To defrost 1.5 pounds of meat.

Place food on microwave safe roasting rack in an appropriately sized dish.

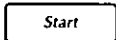
| | |
|--|--|
| 1.  | • Press. "def" appears briefly on the Display Window . |
| 2.  | • Enter weight of the food using the number pads. |
| 3.  | • Press. ► Defrosting will start. The time on the Display Window will count down. Halfway through defrosting, beep sounds. Turn over, rearrange foods, remove defrost areas or shield with aluminum foil. (See directions "DURING DEFROSTING" in page 11.) |

Conversion Chart:

Follow the chart to convert ounces or hundredths of a pound into tenths of a pound. To use Auto Defrost, program the weight of the food in lbs. (1.0) and tenths of a lb. (0.1). If a piece of meat weighs 1.95 lbs. or 1 lb. 14 oz., program 1.9 lbs.

| Ounces | Hundredths of a Pound | Tenths of a Pound |
|---------|-----------------------|-------------------|
| 0 | .01 - .05 | 0.0 |
| 1 - 2 | .06 - .15 | 0.1 |
| 3 - 4 | .16 - .25 | 0.2 |
| 5 | .26 - .35 | 0.3 |
| 6 - 7 | .36 - .45 | 0.4 |
| 8 | .46 - .55 | 0.5 |
| 9 - 10 | .56 - .65 | 0.6 |
| 11 - 12 | .66 - .75 | 0.7 |
| 13 | .76 - .85 | 0.8 |
| 14 - 15 | .86 - .95 | 0.9 |

Defrosting Tips & Techniques

Before Freezing:

1. Freeze meats, poultry, and fish in packages with only 1 or 2 layers of food. Place wax paper between layers.
2. Package in heavy-duty plastic wraps, bags (labeled "For Freezer") or freezer paper.
3. Remove as much air as possible, i.e. create a vacuum.
4. Seal securely, date, and label.

To Defrost:

1. Remove wrapper. This helps moisture to evaporate. Juices from food can get hot and cook the food.
2. Set food on microwave safe roasting rack in an appropriately sized dish.
3. Place roasts fat-side down. Place whole poultry breast-side down.
4. Drain liquids during defrosting.
5. Turn over (invert) items during defrosting.
6. Shield edges and ends if needed. (See **Cooking Techniques**).
7. Select power and minimum time so that items will be under-defrosted.

After Defrosting:



1. Large items may be icy in the center. Defrosting will complete during **STANDING TIME**.
2. Let stand, covered with plastic wrap, in the refrigerator for time shown in the chart below.
3. See chart below for standing time and rinsing directions.
4. Items which have been layered should be rinsed separately or have a longer stand time.

| FOOD | DEFROST TIME at P3 (min./lb.) | DURING DEFROSTING | AFTER DEFROSTING | |
|--|-------------------------------------|--|--------------------|-------|
| | | | Stand Time | Rinse |
| Fish and Seafood [up to 3 lbs. (1.4 kg)] | | | | |
| Crabmeat | 6 | Break apart/Rearrange | 5 min. | YES |
| Fish Steaks | 4 to 6 | Turn over | | |
| Fish Fillets | 4 to 6 | Turn over/Rearrange/Shield ends | | |
| Sea Scallops | 4 to 6 | Break apart/Remove defrosted pieces | | |
| Whole fish | 4 to 6 | Turn over | | |
| Meat | | | | |
| Ground Meat | 4 to 5 | Turn over/Remove defrosted portion/ Shield edges | 10 min. | NO |
| Roasts [2½-4 lbs. (1.1-1.8 kg)] | 4 to 8 | Turn over/Shield ends and defrosted surface | 30 min. in refrig. | |
| Chops/Steak | 6 to 8 | Turn over/Rearrange/Shield ends and defrosted surface | 5 min. | |
| Ribs/T-bone | 6 to 8 | Turn over/Rearrange/Shield ends and defrosted surface | | |
| Stew Meat | 4 to 8 | Break apart/Rearrange/ Remove defrosted pieces | | |
| Liver (thin sliced) | 4 to 6 | Drain liquid/Turn over/ Separate pieces | | |
| Bacon (sliced) | 4 | Turn over | | |
| Poultry | | | | |
| Chicken, Whole [up to 3 lbs. (1.4 kg)] | 4 to 6 | Turn over/Shield | 20 min. in refrig. | YES |
| Cutlets | 4 to 6 | Break apart/Turn over/ Remove defrosted Pieces | 5 min. | |
| Pieces | 4 to 6 | Break apart/Turn over/Shield | 10 min. | |
| Cornish Hens | 6 to 8 | Turn over/Shield | | |
| Turkey Breast [5-6 lbs. (2.3-2.7 kg)] | 6 | Turn over/Shield | 20 min. in refrig. | |

Sensor Reheat

This sensor feature allows you to reheat any quantity of food with only one touch. The oven does it all for you.

Example: To reheat 2 cups of soup

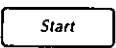
| | | |
|----|---|------------------------------|
| 1. |  | • Press. |
| 2. |  Optional | (see page 9.) |
| 3. |  | • Press. ▶Cooking starts. |

After heat/steam is detected by the **Genius**, 2 beeps sound. The remaining cooking time appears on the **Display Window** and begins to count down.

At the end of cooking, five beeps sound.

NOTES:

Casseroles - Add 3 to 4 tablespoons of liquid; cover with lid or plastic wrap. Stir when time appears on the **Display Window**.

Canned foods - Empty contents into casserole dish or serving bowl; cover dish with lid or plastic wrap. After reheating, release plastic wrap and stand.

Plate of food - Arrange food on plate; top with butter, gravy, etc.. After reheating, release plastic wrap and stand.

Follow the recommendations for Sensor Cooking, in addition to the following:

DO NOT:

1. Reheat bread and pastry products. Use manual power and time for these foods.
2. Reheat raw or uncooked food.
3. Use if oven cavity is warm.
4. Use for beverages.
5. Use for frozen foods.

For the best results with the GENIUS, follow these recommendations.

BEFORE Reheating/Cooking



1. The room temperature surrounding the oven should be below 95° F (35° C).
2. Food weight should exceed 4 oz. (110 g).
3. Glass Tray and outside of container should be dry.
4. Cover food loosely with lid, or with vented plastic wrap.
5. All foods should be taken from their normal storage place.

Sensor Cook

- Breakfast
- Lunch
- Snack
- Side Dish
- Dinner

This sensor feature allows you to cook any quantity of food with only one touch. The oven does it all for you.

Example: To cook a 10 oz. Frozen Entrée.

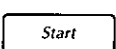
| | | |
|----|---|---|
| 1. |  Press twice. | • Press until the desired number of category appears on the Display Window . |
| 2. |  Optional | (see page 9.) |
| 3. |  | • Press. ▶Cooking starts. |

After heat/steam is detected by the **Genius**, 2 beeps sound. The remaining cooking time appears on the **Display Window** and begins to count down.

At the end of cooking, five beeps sound.

DURING Reheating/Cooking:

DO NOT open the oven door until 2 beeps sound and time appears on the **Display Window**. Doing so will cause inaccurate cooking since the steam from food is no longer contained within the oven cavity. Once the timer begins to count down, the oven door may be opened to stir, turn, shield, rearrange, mix or add foods.

AFTER Reheating/Cooking:

All foods should have a covered stand time.

Sensor Cook Chart

| Pad | Recipe | Serving/Weight | HINTS |
|------------------|--------------------------|--------------------------|--|
| Breakfast | 1. Oatmeal | 1/2 , 1 cup | Place inside a microwave-safe serving bowl with no cover. Follow manufacturers' directions for preparation of quick oatmeal. |
| | 2. Breakfast Sausage | 8 maximum | Follow manufacturers' directions for preparation of pre-cooked breakfast sausage. Place in a radial pattern. |
| | 3. Omelet | 2, 4 eggs | Follow Basic Omelet recipe on page 14. |
| Lunch | 4. Soup | 1 - 2 cups | Pour soup into a microwave-safe serving bowl. Cover loosely with lid or vented plastic wrap. |
| | 5. Frozen Entrées | 8 - 32 oz. | Follow manufacturers' directions for preparation of 8 and 10 oz. sizes. For larger sized entrées, where the directions state for the entire film cover to be removed, do not vent or remove film cover to ensure the sensor will detect accurately for complete cooking. Be careful when removing the film cover after cooking. Remove them away from you to avoid steam burns. If additional time is needed, continue to cook manually. |
| Snack | 6. Frozen Pizza (single) | 4, 8 oz. | Follow manufacturers' directions for preparation. |
| | 7. Hot Dog | 4 maximum | Make 3 slits on each Hot Dog. Place Hot Dog on paper plate or microwave-safe dish leaving space between each. Times may vary by size and manufacturer. |
| Side Dish | 8. Potatoes | 4 maximum (6-8 oz. each) | Pierce at least 6 times on top of the potato with a fork. Place potatoes on a microwave-safe dish. Do not cover. Let stand 5 minutes to complete cooking. |
| | 9. Rice | 1/2 - 1 1/2 cups | Place rice with hot water in a microwave-safe casserole dish. Cover loosely with lid or vented plastic wrap. Let stand 5 to 10 minutes before serving. |
| | 10. Fresh Vegetables | 1/4 - 1 lb. | All pieces should be the same size. Add a small amount of water and cover loosely with lid or vented plastic wrap. |
| Dinner | 11. Chicken Pieces | 1/2 - 2 lb. | Place skin-side up. Cover with vented plastic wrap. Let stand 5 minutes before serving. |
| | 12. Ground Meat | 1 - 2 lb. (16 - 32 oz.) | Break apart in glass bowl or colander. Cover with vented plastic wrap. After 2 beeps, stir. Re-cover and press Start . Juices should be clear. Drain. |
| | 13. Fish Fillets | 1/4 - 1 lb. | Arrange in a single layer. Cover with vented plastic wrap. |
| | 14. Pasta | 2 - 8 oz. | Place pasta with hot water in a microwave-safe casserole dish. Cover loosely with lid or plastic wrap. Drain. |
| | 15. Casserole | = | Prepare according to recipes on page 14. |

Sensor Cook Recipe

OMELET

Basic Omelet

- 1 tablespoon butter or margarine
- 2 eggs
- 2 tablespoons milk
- salt and ground black pepper, if desired

Heat butter in a 9-inch pie plate, 30 seconds at P10, or until melted, turn the plate to coat the bottom with butter.

Meanwhile, combine the remaining ingredients in a separate bowl and beat together; pour into the pie plate.

Cook, covered with vented plastic wrap, on OMELET. Let stand 2 minutes. With a spatula, loosen the edges of the omelet from the plate; fold into thirds to serve.

Yield: 1 serving

Approx. Cooking Time: 4 minutes

NOTE: Double ingredients for a 4 egg Omelet.

CASSEROLE

Shepherd's Pie

- 1 pound lean ground beef
- $\frac{1}{2}$ cup frozen peas, thawed
- $\frac{1}{4}$ cup chopped onion
- 1 tablespoon gravy powder
- $\frac{1}{2}$ teaspoon curry powder
- $\frac{1}{4}$ teaspoon salt
- $\frac{1}{4}$ teaspoon ground black pepper
- 2 cups mashed potatoes

In a 2-Qt. casserole dish, crumble the beef and cook for 5-7 minutes at P6, until the meat is cooked; stirring twice. Add the remaining ingredients, except the potatoes. Stir well and spread the potatoes evenly on the top. Cover with a lid and cook on CASSEROLE.

Yield: 4 servings

Approx. Cooking Time: 17 minutes

Macaroni and Cheese

- $\frac{1}{4}$ cup butter
- 2 tablespoons chopped onion
- 1 clove minced garlic
- $\frac{1}{4}$ cup all purpose flour
- 1 teaspoon dry mustard
- 1 teaspoon salt
- $\frac{1}{4}$ teaspoon ground black pepper
- 2 cups milk
- 2 cups grated cheddar cheese
- 8 oz. ($\frac{1}{2}$ lb dry weight) macaroni, cooked and drained
- $\frac{1}{3}$ cup bread crumbs
- 1 teaspoon paprika

In a 2-Qt. casserole, melt the butter for 40 seconds at P10. Add onion and garlic and cook for 1 minute at P10. Stir in flour, mustard, salt and pepper then, gradually add the milk. Cook for 3-4 minutes at P10, stirring once. Continue cooking for 3-4 minutes at P10 or until the sauce thickens. Stir in the cheddar cheese. Stir the sauce into the macaroni, in a 3-Qt. casserole. Top with bread crumbs and paprika. Cover with vented plastic wrap. Cook on CASSEROLE.

Yield: 6 servings

Approx. Cooking Time: 17 minutes

Beef and Macaroni Casserole

- 1 pound lean ground beef
- 1 small chopped onion
- $\frac{1}{2}$ green bell pepper, chopped
- 1 cup chopped celery
- 2 cans (15 oz.) tomato sauce
- $1\frac{1}{4}$ cups water
- 1 cup uncooked elbow macaroni
- 1 teaspoon parsley
- $\frac{1}{2}$ teaspoon salt
- $\frac{1}{4}$ teaspoon ground black pepper
- $\frac{1}{2}$ cup grated cheddar cheese

Crumble the ground beef in a 3-Qt. casserole. Cook for 5 - 7 minutes at P6 or until the meat is cooked; stirring twice. Add onion, peppers and celery. Cook for 3-4 minutes at P10. Add the remaining ingredients, except cheese. Cover with vented plastic wrap. Cook on CASSEROLE. Sprinkle with cheese. Cover and let stand 5 minutes.

Yield: 4-6 servings

Approx. Cooking Time: 17 minutes

Tuna Casserole

- 1 can (6 oz.) drained and flaked tuna
- 4 cups cooked and drained noodles
- 1 can (10 $\frac{1}{4}$ oz.) condensed cream of mushroom soup
- 1 can (4 oz.) mushroom pieces and steams, drained
- 1 package (16 oz.) frozen peas, defrosted
- $\frac{3}{4}$ cup milk
- 1 cup crushed potato chips
- $\frac{1}{2}$ cup grated cheddar cheese

In a 3-Qt. casserole, combine tuna, noodles, soup, mushrooms, peas and milk; mix well. Cover with vented plastic wrap. Cook on CASSEROLE. Top with potato chips and cheese.

Yield: 4-6 servings



Approx. Cooking Time: 17 minutes

Timer Setting

This feature allows you to program a Standing Time after cooking is completed and to program the oven as a kitchen timer and/or to program a delay start.



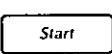

To Use as a Kitchen Timer:

Example: To count 5 minutes

| | |
|--|--|
| 1.  | • Press. |
| 2.  | • Set desired amount of time using number pads. (up to 99 minutes and 99 seconds). |
| 3.  | • Press. ▶ Time will count down without oven operating. |

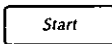

To Set Stand Time:

Example: To stand for 5 mins. after cooking (3 mins. at P6-MEDIUM Power)

| | |
|--|---|
| 1.  5 times ↓  | • Enter the desired cooking program (see page 8 for directions). |
| 2.  | • Press. |
| 3.  | • Set desired amount of Stand Time using number pads. (up to 99 minutes and 99 seconds) |
| 4.  | • Press. ▶ Cooking will start. After cooking, stand time will count down without oven operating. |

To Set Delay Start:

Example: To start cooking 5 minutes later. (3 mins. at P6-MEDIUM Power).

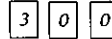
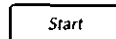
| | |
|---|---|
| 1.  | • Press. |
| 2.  | • Enter desired amount of delayed time using number pads. (up to 99 minutes and 99 seconds) |
| 3.  5 times ↓  | • Enter the desired cooking program (see page 8 for directions). |
| 4.  | • Press. ▶ Delayed time will count down. Then cooking will start. |

NOTES:

1. When each stage finishes, a two-beep signal sounds. At the end of the program, the oven will beep five times.
2. If oven door is opened during Stand Time or Kitchen Timer, the time on the screen will continue to count down.
3. Stand and Delay time cannot be programmed before any Auto Control Function. This is to prevent the starting temperature of food from rising before defrosting or cooking begins. A change in starting temperature could cause inaccurate results.

Microwave Shortcuts

| FOOD | POWER | TIME (in mins.) | DIRECTIONS |
|---|---|---------------------------------------|---|
| To separate Bacon , 1 pound (450 g) | P10 (HIGH) | 30 sec. | Remove wrapper and place in microwave safe dish. After heating, use a plastic spatula to separate slices. |
| To soften Brown Sugar 1 cup (250 mL) | P10 (HIGH) | 20 - 30 sec. | Place brown sugar in microwave-safe dish with a slice of bread. Cover with plastic wrap. |
| To melt Butter , 1 stick, ¼ pound (110 g) | P6 (MEDIUM) | 1½ - 2 | Remove wrapper and place butter in a microwave-safe dish covered with plastic wrap. |
| To soften Butter , 1 stick, ¼ pound (110 g) | P3 (MED-LOW) | 1 | Remove wrapper and place butter in a microwave-safe dish. |
| To melt Chocolate , 1 square, 1 oz. (28 g) | P10 (HIGH) | 1 - 1½ | Remove wrapper and place chocolate in a microwave-safe dish. Stir before adding more time. (Stir until completely melted.) <i>Note: Chocolate holds its shape even when softened.</i> |
| To melt Chocolate , ½ cup (125 mL) chips | P10 (HIGH) | 1 - 1½ | |
| To toast Coconut , ½ cup (125 mL) | P10 (HIGH) | 1 | Place in a microwave-safe dish. Stir every 30 seconds. |
| To soften Cream Cheese , 8 oz. (250 g) | P3 (MED-LOW) | 1 - 2 | Remove wrapper and place in a microwave-safe bowl. |
| To brown Ground Beef , 1 pound (450 g) | P10 (HIGH) | 4 - 5 | Crumble into a microwave-safe colander set into another dish. Stir twice. Drain grease. |
| To steam Hand Towels - 4 | P10 (HIGH) | 20 - 30 sec. | Soak in water, then wring out excess. Place on a microwave-safe dish. Heat. Present immediately. |
| To soften Ice Cream , ½ gallon (2 L) | P3 (MED-LOW) | 1 - 1½ | Check often to prevent melting. |
| Cup of liquid boiling water, broth, etc. 1 cup, 8 oz. (250 mL) 2 cups, 16 oz. (500 mL) to heat milk 1 cup, 8 oz. (250 mL) 2 cups, 16 oz. (500 mL) | P10 (HIGH) P7 (MED-HIGH) | 2½ - 3 4 2 - 3 4 - 5 | Heated liquids can erupt if not stirred. Do not heat liquids in microwave oven without stirring before and after heating. |
| To roast Nuts , 1½ cups (375 mL) | P10 (HIGH) | 4 - 5 | |
| To toast Sesame Seeds , ¼ cup (50 mL) | P10 (HIGH) | 3 - 5 | Place in a small microwave-safe bowl. Stir twice. |
| To skin Tomatoes (one at a time) | P10 (HIGH) | 30 sec. | Place tomato into a microwave-safe bowl containing boiling water. Rinse and peel. Repeat for each tomato. |
| To remove Cooking Odors | P10 (HIGH) | 5 | Combine 1 to 1½ cups (250 - 375 mL) water with the juice and peel of one lemon in a small microwave-safe bowl. After heating, wipe interior of oven with a cloth. |

Food Characteristics

Bone and Fat

Both bone and fat affect cooking. Bones may cause irregular cooking. Meat next to the tips of bones may overcook while meat positioned under a large bone, such as a ham bone, may be undercooked. Large amounts of fat absorb microwave energy and the meat next to these areas may overcook.

Density

Porous, airy foods such as breads, cakes or rolls take less time to cook than heavy, dense foods such as potatoes and roasts. When reheating donuts or other foods with different centers be very careful. Certain foods have centers made with sugar, water, or fat and these centers attract microwaves (For example, jelly donuts). When a jelly donut is heated, the jelly can become extremely hot while the exterior remains warm to the touch. This could result in a burn if the food is not allowed to cool properly in the center.

Quantity

Two potatoes take longer to cook than one potato. As the quantity of the food increases so does the cooking time. When cooking small amounts of food such as one or two potatoes, do not leave oven unattended. The moisture content in the food may decrease and a fire could result.

Shape

Uniform sizes heat more evenly. The thin end of a drumstick will cook more quickly than the meaty end. To compensate for irregular shapes, place thin parts toward the center of the dish and thick pieces toward the edge.

Size

Thin pieces cook more quickly than thick pieces.

Starting Temperature

Foods that are room temperature take less time to cook than if they are chilled, refrigerated, or frozen.

Cooking Techniques

Piercing



Foods with skins or membranes must be pierced, scored or have a strip of skin peeled before cooking to allow steam to escape. Pierce whole egg yolks and whites, clams, oysters, chicken livers, whole potatoes and whole vegetables. Whole apples or new potatoes should have a 1-inch strip of skin peeled before cooking. Score sausages and frankfurters.

Browning



Foods will not have the same brown appearance as conventionally cooked foods or those foods which are cooked utilizing a browning feature. Meats and poultry may be coated with browning sauce, Worcestershire sauce, barbecue sauce or shake-on browning sauce. To use, combine browning sauce with melted butter or margarine; brush on before cooking. For quick breads or muffins, brown sugar can be used in the recipe in place of granulated sugar, or the surface can be sprinkled with dark spices before baking.

Cooking Techniques

Spacing

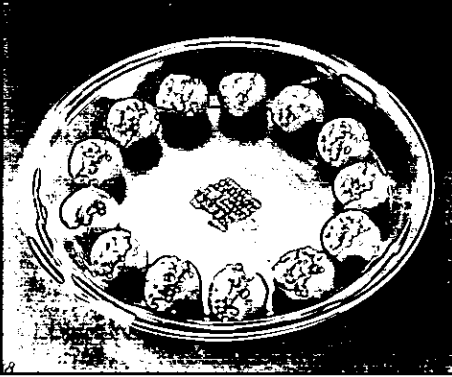

Individual foods, such as baked potatoes, cupcakes and appetizers, will cook more evenly if placed in the oven equal distances apart. When possible, arrange foods in a circular pattern.

Covering

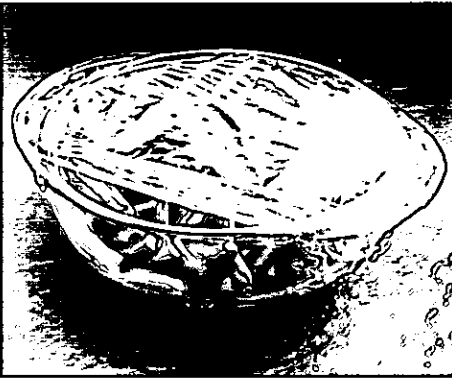

As with conventional cooking, moisture evaporates during microwave cooking. Casserole lids or plastic wrap are used for a tighter seal. When using plastic wrap, vent the plastic wrap by folding back part of the plastic wrap from the edge of the dish to allow steam to escape. Loosen or remove plastic wrap as recipe directs for stand time. When removing plastic wrap covers, as well as any glass lids, be careful to remove them away from you to avoid steam burns. Various degrees of moisture retention are also obtained by using wax paper or paper towels. However, unless specified, a recipe is cooked covered.

Shielding

Thin areas of meat and poultry cook more quickly than meaty portions. To prevent overcooking, these thin areas can be shielded with strips of aluminum foil. Wooden toothpicks may be used to hold the foil in place.

Timing

A range in cooking time is given in each recipe. The time range compensates for the uncontrollable differences in food shapes, starting temperature, and regional preferences. Always cook food for the minimum cooking time given in a recipe and check for doneness. If the food is undercooked, continue cooking. It is easier to add time to an undercooked product. Once the food is overcooked, nothing can be done.

Stirring

Stirring is usually necessary during microwave cooking. We have noted when stirring is helpful, using the words once, twice, frequently, or occasionally to describe the amount of stirring necessary. Always bring the cooked outside edges toward the center and the less cooked center portions toward the outside of the dish.

Rearranging

Rearrange small items such as chicken pieces, shrimp, hamburger patties, or pork chops. Rearrange pieces from the edge to the center and pieces from the center to the edge of the dish.

Turning

It is not possible to stir some foods to redistribute the heat. At times, microwave energy will concentrate in one area of a food. To help insure even cooking, these foods need to be turned. Turn over large foods, such as roasts or turkeys, halfway through cooking.

Stand Time

Most foods will continue to cook by conduction after the microwave oven is turned off. In meat cookery, the internal temperature will rise 5°F to 15°F (3°C to 8°C), if allowed to stand, tented with foil, for 10 to 15 minutes. Casseroles and vegetables need a shorter amount of standing time, but this standing time is necessary to allow foods to complete cooking to the center without overcooking on the edges.

Test for Doneness

The same tests for doneness used in conventional cooking may be used for microwave cooking. Meat is done when fork-tender or splits at fibers. Chicken is done when juices are clear yellow and drumstick moves freely. Fish is done when it flakes and is opaque. Cake is done when a toothpick or cake tester is inserted and comes out clean. Candy is done when it reaches the proper temperature for each stage of crystallization.

Care of Your Microwave Oven

BEFORE CLEANING:

Unplug at socket of the oven. If impossible, leave oven door open to prevent oven from accidentally turning on.

AFTER CLEANING:

Be sure to replace the Roller Ring and Glass Tray in the proper position and press **Stop/Reset** Pad to clear the display window.

Inside of the oven:
Wipe with a damp cloth. Mild detergent may be used if the oven gets very dirty. The use of harsh detergent or abrasives is not recommended.

Glass Tray:
Remove and wash in warm soapy water or in a dishwasher.

Outside oven surfaces.
Clean with a damp cloth. To prevent damage to the operating parts inside the oven, water should not be allowed to seep into ventilation openings.

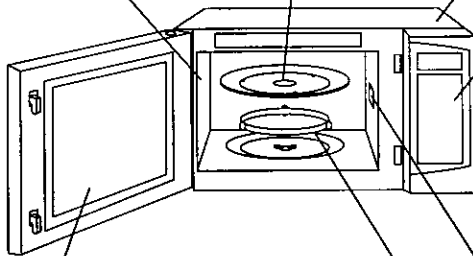

Control Panel:

- * Covered with a removable protective film to prevent scratches during shipping. Small bubbles may appear under this film. (Hint - To remove film, apply masking or clear tape to an exposed corner and pull gently.)
- * If the Control Panel becomes wet, clean it with a soft dry cloth. Do not use harsh detergents or abrasives on the Control Panel.

Oven Door:

Wipe with a soft cloth when steam accumulates inside or around the outside of the oven door. During cooking, especially under high humidity conditions, steam is given off from the food. (Some steam will condense on cooler surfaces, such as the oven door. This is normal.)

* Inside surface is covered with a heat and vapour barrier film. Do not remove.

Do not remove cover.

Roller Ring and oven cavity floor:

Wipe the bottom surface of the oven with mild detergent water or window cleaner and dry. Roller Ring may be washed in mild soapy water or dishwasher. These areas should be kept clean to avoid excessive noise.

ORDER FORM

DESCRIPTION

PART NUMBER

Instruction / Operating Manual (this book)
Glass Tray
Roller Ring Assembly

F00035L00AP
F06014T00AP
F290D9330AP

For pricing quotes, call or write the Parts & Literature Department at the phone or address listed below. Please have your credit card information readily available.

Shipping & handling are not included. Price & availability subject to change. Sorry, no COD's.

PANASONIC SERVICES COMPANY
20421 84th Avenue South
Kent, WA 98032

(800) 833-9626 - Phone
(800) 237-9080 - FAX

You can purchase parts, accessories or locate your nearest servicer by visiting our Web Site:

Web Site: <http://www.Panasonic.com>

Before Requesting Service

All these things are normal:

The oven causes interference with my TV.

Some radio and TV interference might occur when you cook with the microwave oven. This interference is similar to the interference caused by small appliances such as mixers, vacuums, blow dryers, etc. It does not indicate a problem with your oven.

Steam accumulates on the oven door and warm air comes from the oven vents.

During cooking, steam and warm air are given off from the food. Most of the steam and warm air are removed from the oven by the air which circulates in the oven cavity. However, some steam will condense on cooler surfaces such as the oven door. This is normal.

I accidentally ran my microwave oven without any food in it.

Running the oven empty for a short time will not damage the oven. However, we do not recommend operating the microwave oven without any food in it.

| PROBLEM | POSSIBLE CAUSE | REMEDY |
|--|--|---|
| Oven will not turn on. | The oven is not plugged in securely. | Remove plug from outlet, wait 10 seconds and reinsert. |
| | Circuit breaker or fuse is tripped or blown. | Reset circuit breaker or replace fuse. |
| | There is a problem with the outlet. | Plug another appliance into the outlet to check if it is working. |
| Oven will not start cooking. | The door is not closed completely. | Close the oven door securely. |
| | Start Pad was not pressed after programming. | Press Start Pad. |
| | Another program is already entered into the oven. | Press Stop/Reset Pad to cancel the previous program and enter new program. |
| | The program is not correct. | Program again according to the Operating Instructions. |
| When the oven is operating, there is noise coming from the glass tray. | Stop/Reset Pad has been pressed accidentally. | Program oven again. |
| | The Roller Ring and oven bottom are dirty. | Clean these parts according to Care of Your Microwave Oven . |

Limited Warranty & Customer Services Directory

PANASONIC CONSUMER ELECTRONICS COMPANY,
DIVISION OF MATSUSHITA ELECTRIC
CORPORATION OF AMERICA
One Panasonic Way
Secaucus, New Jersey 07094

PANASONIC SALES COMPANY,
DIVISION OF MATSUSHITA
ELECTRIC OF PUERTO RICO, INC.,
Ave. 65 de Infanteria, Km. 9.5
San Gabriel Industrial Park
Carolina, Puerto Rico 00985

Panasonic Microwave Oven Product Limited Warranty

Limited Warranty Coverage

If your product does not work properly because of a defect in materials or workmanship, Panasonic Consumer Electronics Company or Panasonic Sales Company (collectively referred to as "the warrantor") will, for the length of the period indicated on the chart below, which starts with the date of original purchase ("warranty period"), at its option either (a) repair your product with new or refurbished parts, or (b) replace it with a new or a refurbished product. The decision to repair or replace will be made by the warrantor.

| | PARTS | LABOR |
|--|----------------------|---------------------|
| ALL PARTS (EXCEPT MAGNETRON TUBE) | 1 (ONE) YEAR | 1 (ONE) YEAR |
| MAGNETRON TUBE | 5 (FIVE) YEAR | 1 (ONE) YEAR |

During the "Labor" warranty period there will be no charge for labor. During the "Parts" warranty period, there will be no charge for parts. You must carry-in or mail-in your product during the warranty period. This warranty only applies to products purchased and serviced in the United States or Puerto Rico. This warranty is extended only to the original purchaser of a new product which was not sold "as is". A purchase receipt or other proof of the original purchase date is required for warranty service.

Carry-In or Mail-In Service

For Carry-In or Mail-In Service in the United States call 1-800-211-PANA(7262) or visit Panasonic Web Site: <http://www.panasonic.com>

For assistance in Puerto Rico call Panasonic Sales Company (787)-750-4300 or fax (787)-768-2910.

Limited Warranty Limits And Exclusions

This warranty ONLY COVERS failures due to defects in materials or workmanship, and DOES NOT COVER glass, plastic parts, temperature probes (if included) and normal wear and tear or cosmetic damage. The warranty ALSO DOES NOT COVER damages which occurred in shipment, or failures which are caused by products not supplied by the warrantor, or failures which result from accidents, misuse, abuse, neglect, mishandling, misapplication, alteration, faulty installation, set-up adjustments, misadjustment of consumer controls, improper maintenance, power line surge, lightning damage, modification, or commercial use (such as in a hotel, office, restaurant, or other business), rental use of the product, service by anyone other than a Factory Servicenter or other Authorized Servicer, or damage that is attributable to acts of God.

THERE ARE NO EXPRESS WARRANTIES EXCEPT AS LISTED UNDER "LIMITED WARRANTY COVERAGE". THE WARRANTOR IS NOT LIABLE FOR INCIDENTAL OR CONSEQUENTIAL DAMAGES RESULTING FROM THE USE OF THIS PRODUCT, OR ARISING OUT OF ANY BREACH OF THIS WARRANTY. (As examples, this excludes damages for lost time, cost of having someone remove or re-install an installed unit if applicable, or travel to and from the servicer. The items listed are not exclusive, but are for illustration only.) **ALL EXPRESS AND IMPLIED WARRANTIES, INCLUDING THE WARRANTY OF MERCHANTABILITY, ARE LIMITED TO THE PERIOD OF THE LIMITED WARRANTY.**

Some states do not allow the exclusion or limitation of incidental or consequential damages, or limitations on how long an implied warranty lasts, so the exclusions may not apply to you.

This warranty gives you specific legal rights and you may also have others rights which vary from state to state. If a problem with this product develops during or after the warranty period, you may contact your dealer or Servicenter. If the problem is not handled to your satisfaction, then write to the warrantor's Consumer Affairs Department at the addresses listed for the warrantor.

PARTS AND SERVICE WHICH ARE NOT COVERED BY THIS LIMITED WARRANTY ARE YOUR RESPONSIBILITY.

Customer Services Directory

For Product Information, Operating Assistance, Literature Request, Dealer Locations, and all Customer Service inquiries please contact:
1-800-211-PANA (7262), Monday-Friday 9 am-9 pm; Saturday-Sunday 9 am-7 pm, EST.

**Web Site: <http://www.panasonic.com>
you can purchase parts, accessories or locate your
nearest servicenter by visiting our Web Site.**

Accessory Purchases

1-800-332-5368 (Customer Orders Only)
Panasonic Services Company 20421 84th Avenue South, Kent, WA 98032
(6 am to 5 pm Monday-Friday; 6 am to 10:30 am Saturday; PST)
(Visa, MasterCard, Discover Card, American Express, Check)

Service in Puerto Rico

Matsushita Electric of Puerto Rico, Inc. Panasonic Sales Company/Factory Servicenter:
Ave. 65 de Infanteria, Km. 9.5, San Gabriel Industrial Park, Carolina, Puerto Rico 00985
Phone (787) 750-4300 Fax (787) 768-2910

INSTRUCCIONES DE SEGURIDAD

Su horno de microondas es un artículo para cocinar y usted debe usarlo con tanto cuidado como usa una estufa o cualquier otro artículo para cocinar.

Cuando utilice este aparato eléctrico, se deben seguir precauciones básicas de seguridad, incluyendo las siguientes:

ADVERTENCIA—Para reducir el riesgo de quemaduras, electrocuciones, fuegos, lesiones a personas o exposición a una energía de microondas:

1. Lea todas las instrucciones antes de usar el aparato.
2. Lea y siga las "PRECAUCIONES PARA EVITAR POSIBLE EXPOSICION EXCESIVA A ENERGIA DE MICROONDAS" específicas, que se encuentran abajo.
3. Este aparato debe ser conectado a tierra. Conecte solamente a la toma eléctrica debidamente conectada a tierra. Vea las "INSTRUCCIONES PARA CONEXION A TIERRA" que se encuentran en la página 23.
4. Instale o ubique este aparato solamente de acuerdo con las instrucciones de instalación que se encuentran en la página 23.
5. No cubra ni tape ninguna de las rendijas de este aparato.
6. No almacene o use este aparato en exteriores. No use este aparato cerca del agua - por ejemplo, cerca del fregadero de la cocina, en una base mojada, o cerca de una alberca, y similares.
7. Use este aparato sólo para los fines para los que fué hecho, tal como se describen en este manual. No use químicos o vapores corrosivos en este aparato. Este tipo de horno está específicamente diseñado para calentar o cocinar alimentos. No fué diseñado para uso industrial o de laboratorio.
8. Cuando limpie las superficies de la puerta y el horno que vienen juntas al cerrar la puerta, use solamente jabones no abrasivos o detergentes suaves aplicados con una esponja o con tela suave.
9. No permita a los niños usar este aparato, a menos que sean supervisados muy de cerca por un adulto.
10. No use este aparato si tiene dañado el cordón o la clavija, si no está trabajando adecuadamente, o si ha sido dañado o se ha dejado caer.
11. No sumergir en agua el cable o la clavija.
12. Mantenga el cordón lejos de superficies calientes.
13. No deje el cordón colgando en el borde de la mesa o mostrador.
14. Este aparato debe recibir mantenimiento sólo de personal calificado. Contacte las instalaciones de servicio

autorizadas más cercanas para revisión, reparación o ajuste.

15. Algunos productos, tales como los huevos completos y contenedores sellados - por ejemplo frascos de vidrio cerrados - pueden explotar y no deben ser calentados en este horno.

16. Para reducir el riesgo de incendio en la cavidad del horno:

(a) No sobrecocine los alimentos. Preste atención cuidadosamente al aparato. El papel, plástico u otros materiales combustibles son colocados dentro del horno para facilitar la cocción pero si no se utilizan adecuadamente esto puede producir incendio en su horno.

(b) Quite los sujetadores de alambre de las bolsas de papel o plástico antes de colocar la bolsa en el horno.

(c) Quite los sujetadores de alambre de las bolsas de papel o plástico antes de colocar la bolsa en el horno.

(d) No use la cavidad con propósitos de almacenaje. No deje productos de papel, utensilios de cocina o alimentos en la cavidad cuando no esté en uso.

17. Líquidos, tales como agua, café, o té pueden ser calentados por sobre el punto de ebullición sin parecer estar ebullendo debido a la tensión de superficie del líquido. A veces el burbujeo o ebullición no son visibles cuando el recipiente es removido del horno de microondas. ESTO PUEDE RESULTAR EN UNA EBULLICION REPENTINA DEL LIQUIDO MUY CALIENTE CUANDO SE INTRODUZCA UNA CUCHARA U OTRO UTENSILIO DENTRO DEL LIQUIDO. Para reducir el riesgo de heridas a personas:

(a) No sobrecaliente el líquido.

(b) Revuelva el líquido antes y durante el calentamiento.

(c) No utilice recipientes de lados rectos con cuello angosto.

(d) Luego del calentamiento, deje estar el recipiente dentro del horno de microondas por un corto tiempo antes de retirarlo.

(e) Sea muy cuidadoso cuando introduzca cucharas u otros utensilios dentro del recipiente.

Guarde estas instrucciones

PRECAUCIONES PARA EVITAR POSIBLE EXPOSICION EXCESIVA A ENERGIA DE MICROONDAS

- (a) No intente hacer funcionar este horno con la puerta abierta ya que esto puede resultar peligroso. Es importante no anular o biogear los mecanismos de seguridad.
- (b) No coloque ningún objeto entre el panel frontal del horno y la puerta, ni permita que se acumule basura o residuos de limpiadores en las superficies de sellado.
- (c) No haga funcionar el horno si está dañado, es importante que la puerta del horno abra y cierre apropiadamente:
 - (1) la puerta (combada)
 - (2) bisagras y seguro de la puerta (rotos o sueltos)
 - (3) sellos de las puertas y superficies de sellado
- (d) El horno o deberá ser ajustado o reparado por ninguna persona, excepto el personal de servicio debidamente calificado.

INSTRUCCIONES DE SEGURIDAD

Uso General

1. **NO** altere o haga ningún ajuste o reparación a la puerta, al alojamiento del panel de control, interruptores entrecruzados de seguridad o a cualquier otra parte del horno. **NO** quite el panel exterior del horno. Las reparaciones deben ser hechas solamente por personal de servicio calificado.
2. **NO** opere el horno vacío. La energía de microondas se reflejará continuamente a través del horno si los alimentos o agua no están presentes para absorber energía. Esto puede dañar el horno y resultar en peligro de incendio.
3. **NO** utilice este horno para calentar químicos o cualquier otros productos no alimenticios. **NO** limpie este horno con cualquier producto etiquetado con contenido químico corrosivo. El calentamiento de químicos corrosivos en este horno puede causar fugas de radiación.
4. **NO** seque telas, periódicos u otros materiales en el horno. Pueden incendiarse.
5. **NO** use productos de papel reciclado, ya que pueden contener impurezas que pueden causar chispas y/o incendios cuando se usen.
6. **NO** use periódicos o bolsas de papel para cocinar. Puede causar un incendio.
7. **NO** pegue, **NO** golpee el panel de control. Pueden causarse daños a los controles. Puede causar un incendio.
8. Las manoplas para tomar cosas calientes siempre deben ser utilizados cuando se retiren cosas de el horno. El calor se transfiere de los alimentos calientes a los contenedores para cocinar y de los contenedores a la Bandeja de Cristal. La Bandeja de Cristal puede estar muy caliente después de sacar los contenedores para cocinar del horno.
9. **NO** almacene materiales inflamables cerca, arriba, o dentro del horno. Pueden ser riesgos de incendio.

INSTRUCCIONES PARA CONEXION A TIERRA

Este aparato debe ser conectado a tierra. En el caso de un corto circuito, la conexión a tierra reduce el riesgo de una descarga eléctrica proporcionando una línea de escape para la corriente eléctrica. Este aparato está equipado con un cable y clavija para conexión a tierra. La clavija debe ser conectada en un receptor que esté instalado adecuadamente y conectado a tierra.

PRECAUCION - El uso inapropiado de la clavija para conexión a tierra puede resultar en riesgo de descarga eléctrica.

Consulte a un electricista o a personal de servicio calificados, si las instrucciones para conectar a tierra no son completamente comprendidas o si existe duda de que el aparato está correctamente conectado a tierra. Si es necesario usar un cable de extensión, use solamente cable de extensión de tres hilos que tenga una clavija de tres entradas para conectar a tierra, y un receptor de tres ranuras que

acepte la clavija del aparato. El calibre marcado en el cable de extensión debe ser igual o mayor al calibre eléctrico del aparato.

Suministro Eléctrico

1. Se provee un cable de suministro eléctrico corto para reducir los riesgos resultantes de enredarse o tropezarse con un cable más largo.
2. Juegos de cable más largos o extensiones están disponibles y pueden utilizarse si se usan con cuidado.
3. Si se usa un cable más largo o extensión, (1) el calibre eléctrico marcado en el juego de cordón o extensión debe ser al menos tan grande como el calibre eléctrico del aparato, (2) el cable de extensión debe ser de tres hilos del tipo de conexión a tierra, y (3) el cordón más largo debe ser arreglado de tal forma que no caiga sobre la cubierta del mostrador o de la mesa donde pueda ser jalado por niños o tropezarse accidentalmente.

INSTRUCCIONES DE INSTALACION

Examine Su Horno

Desempaque el horno, quite todo el material de empaque y examine que su horno no tenga ningún daño, tales como abolladuras, seguros de la puerta rotos o resquebrajaduras en la puerta. Notifique inmediatamente a su distribuidor si el horno está dañado.

Ubicación del Horno

1. El horno debe ser colocado en una superficie plana y estable. Para su operación apropiada, el horno debe tener suficiente corriente de aire. Deje 8 cm de espacio de ambos lados del horno y 2.5 cm de espacio en la parte superior del horno.

a. **NO** bloquee la ventilación del aire.

Si es bloqueada la ventilación del aire durante la operación, el horno puede sobrecalentarse y quemarse.

Cuando use algún trapo, franela o funda para cubrir el horno, las tomas y salidas del aire no deberán ser bloqueadas. También debe tener un espacio apropiado para la parte trasera y los costados.

b. **NO** coloque el horno cerca de una superficie húmeda caliente, tal como un registro de gas o eléctrico.

c. **NO** opere el horno cuando la humedad del cuarto sea muy alta.

2. Este horno ha sido fabricado para uso en el hogar solamente.

Interferencia de Radio

1. La operación de su horno de microondas puede causar interferencia en su radio, TV o equipo similar.

2. Cuando hay interferencia, se puede reducir o eliminar tomando las siguientes medidas:

a. Limpie la puerta y las superficies selladoras del horno. (Vea Cuidados de Su Horno de Microondas que se encuentran en la página 29).

b. Ponga el radio, TV, etc. lo más lejos posible del horno de microondas.

c. Use una antena instalada adecuadamente para obtener una recepción de señal más fuerte.

Requerimientos de cableado

1. El horno debe estar en un circuito separado. Ningún otro aparato debe compartir el circuito con el horno. Si lo hace el fusible del circuito puede estallar, el bloqueador del circuito trabarse o la comida cocinarse más lento que en los tiempos recomendados en este manual.

2. El voltaje usado debe ser el mismo al especificado en el horno de microondas (120 V.). Usar un voltaje más alto es peligroso y puede resultar en fuego u otro accidente causando daño al horno. Usar un bajo voltaje dará como resultado un cocinado más lento. Panasonic NO es responsable por cualquier daño que haya resultado del uso del horno con un voltaje distinto al especificado.

3. El horno debe ser conectado en un enchufe a tierra de al menos 20 amp 120 volt, 60 Hz. Donde se encuentre un enchufe estándar de 2 entradas es responsabilidad y obligación del consumidor reemplazarlo por un enchufe a tierra de 3 entradas.



Especificaciones Técnicas

| | NN-S562/NN-S592 |
|---|------------------------|
| Potencia Fuente de Poder: | 11,5 A, 1 320 W |
| Potencia de Salida:* | 1 300 W |
| Dimensiones Exteriores (Alto x Ancho x Fondo): | 301 x 518 x 404 mm |
| Dimensiones Cavidad del Horno (Alto x Ancho x Fondo): | 225 x 375 x 386 mm |
| Frecuencia: | 2 450 MHz |
| Peso Sin Embalaje: | Approx. 10,5 kg |

*Determinado de acuerdo a procedimientos contemplados en la normal IEC 705-88. Las especificaciones están sujetas a cambios sin previo aviso.

Sugerencias Útiles

Siga Esta Precauciones de Seguridad Cuando Cocine en Su Horno

IMPORTANTE

La cocción adecuada depende del tiempo designado y del peso de los alimentos. Si usa una porción menor de la recomendada y cocina por el tiempo para la porción recomendada, puede resultar un incendio. Si ocurre un incendio, ponga el horno en posición de apagado y manténgalo cerrado. Desconecte la energía eléctrica o desconecte la caja de fusibles o el panel de control.

1) ENLATADO CASERO/ALIMENTOS DESHIDRATADOS/PEQUEÑAS CANTIDADES DE ALIMENTOS

- No use su horno para el enlatado casero o para calentar cualquier frasco cerrado. La presión aumentará y el frasco puede explotar. Su horno no puede mantener los alimentos a la temperatura apropiada de enlatado.
- Pequeñas cantidades de alimento o alimentos con bajo contenido de humedad se pueden secar, quemar o incendiarse.
- No seque alimentos, hierbas, frutas o vegetales en su horno.

2) PALOMITAS DE MAÍZ

Las palomitas de maíz deben prepararse en un recipiente para palomitas de maíz adecuada para horno de microondas. Palomitas de maíz para horno de microondas que se preparan en su propio paquete también están disponibles. Siga las instrucciones del fabricante de palomitas de maíz y use una marca adecuada para la potencia de su horno de microondas. Nunca deje desalentado el horno cuando prepare palomitas de maíz.

PRECAUCIÓN

Cuando use palomitas de maíz para microondas previamente empacado siga las instrucciones recomendadas en el paquete. Revise el peso del paquete antes de usar la tecla de palomitas de maíz. Prepare el horno para el peso del paquete de palomitas de maíz. Si no se siguen estas instrucciones, las palomitas de maíz pueden no reventar adecuadamente o pueden encenderse y causar un incendio.

3) FREIR CON MUCHA GRASA

- No trate de freir con mucha grasa en su horno de microondas. Cocinar aceites puede estallar en flamas y puede causar daño al horno y quizá acabar en quemaduras. Los utensillos de microondas pueden no ser útiles para soportar la temperatura del aceite caliente, y podrían romperse.

4) HUEVOS

- No caliente huevos en su cascara en el horno de microondas. La presión subirá y el huevo explotará.

5) ALIMENTOS CON PIELS NO POROSAS

- Papas, manzanas, yemas de huevo, cal-

abazas completas y salchichas son ejemplos de alimentos con pieles no porosas. Estos tipos de alimentos deben ser perforados antes de cocinarlos en Microondas para evitar que Estallen.

- Use papas frescas para hornear y cocinelas hasta que estén listas. Cocinar demasiado causa deshidratación y puede producir un incendio. Use los pesos recomendados o puede ocurrir un incendio.
- ### 6) BANDEJA DE CRISTAL/UTENSILIOS DE COCINA/PAPEL ALUMINIO
- Los utensillos para cocinar se calientan durante la cocción en microondas. Use soportes para lo caliente, cuando saque los utensillos del horno o cuando quite tapas o cubiertas de envoltura de plástico de los utensillos de cocina, para evitar quemaduras.
 - La bandeja de cristal se calentará durante la cocción. Debe permitirse que se enfríe antes de manejarla o antes de colocar productos de papel, tales como platos de papel o bolsas de palomitas de maíz para microondas, para cocinar.
 - Cuando se use papel aluminio, brochetas, rejillas para calentar o utensillos hechos de metal en el horno, deje por lo menos 2,5 cm de espacio entre el material de metal y las paredes interiores del horno. Si arquea (chispea) quite el material de metal (brochetas etc.) y/o cambie a un contenedor no metálico.
 - Platos con adornos metálicos no deberan ser usados, ya que puede producirse arco eléctrico.
- ### 7) TOALLAS DE PAPEL/TELAS
- No use toallas de papel o telas que contengan fibras sintéticas en su tejido. La fibra sintética puede causar que la toalla se incendie.
 - No use bolsas de papel o productos de papel recilado en el horno de microondas.
- ### 8) BANDEJA DORADOR/BOLSAS PARA COCINAR EN HORNO
- Los bandeja doradora o asados son diseñados para cocinar en microondas solamente. Siempre siga las instrucciones dadas por el fabricante. No precaliente la bandeja doradora mas de 8 min.
 - Si se usa una bolsa para cocinar para el microondas, prepare de acuerdo a las instrucciones del paquete. No use sujetadores de alambre para cerrar la bolsa.
- ### 9) TERMÓMETROS
- No use termómetros convencionales para alimentos en su horno. Puede producir arco.
- ### 10) GUIA DE USO GENERAL DEL HORNO/PUERTA DEL HORNO
- No use el horno por cualquier razón que no sea la preparación de alimentos.
 - No deje sin atención el horno mientras esté en uso.

Panel de Control

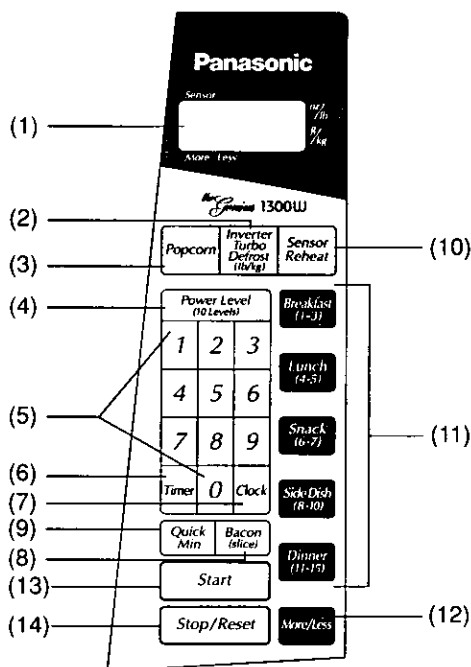

- (1) Pantalla indicadora (Ventana de Visualización)
- (2) Pulsador de descongelamiento turbo inverter
- (3) Pulsador de palomitas de maíz
- (4) Pulsador de potencia
- (5) Pulsadores de numéricos
- (6) Pulsador de tiempo
- (7) Pulsador de reloj
- (8) Pulsador de tocino
- (9) Pulsador de rapido en minutos
- (10) Pulsador de recalentamiento sensor
- (11) Pulsadores de coccion de sensor
- (12) Pulsador de más / menos
- (13) Pulsador Para Comenzar
- (14) Pulsador Para/Cancelar

Luz interior del Horno de Microondas:

La luz interior del Horno de Microondas se enciende unicamente mientras se esta cocinando y no encendera cuando la puerta del horno sea abierta.

¡Vamos a empezar a usar su horno!

1. Enchufe en una toma eléctrica debidamente conectada a tierra.



En el horno aparecera el peso en "oz/lb"

Ventana de Visualización

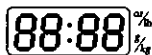

2. Si desea usar gr/kg:

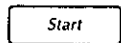

Presione Start (Encender)
Verifique su seleccion en la **Ventana de Visualización**.

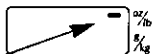

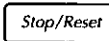
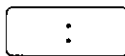
3.  Dos puntos apareceran en la **Ventana de Visualización**
Presione 

Ahora, disfrute cocinando con su microondas Panasonic.

Seguro Para Niños

Esta función evita la operacion del horno hasta que se cancela. No asegura la puerta.

Para Activar

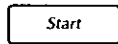

Presione tres veces

- La palabra "Child" aparecera en la **Ventana de Visualización**.
- ▶ "Child" Se mantendra hasta que se cancela. Si los pulsadores son presionados el horno no trabajara.

Para Desactivar

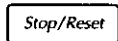



Presione tres veces

- La **Ventana de Visualización** regresa a los dos puntos o la hora.

Operación Manual (Ajuste de Potencia y Tiempo)

Esta función le permite ajustar manualmente la potencia y tiempo para la cocción del microondas.

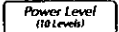
Ejemplo: Para cocinar en P6 durante 1 minuto 30 segundos.

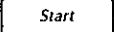
| | |
|---|---|
| 1.  Presione cinco veces | • Seleccione el nivel de potencia. |
| 2.  | • Seleccione el tiempo de cocción. |
| 3.  Presioné | • El tiempo de cocción aparece y empieza la cuenta regresiva. |

| Pulsar Nivel de Potencia | Nivel de Potencia |
|--------------------------|--------------------------------|
| once | P10 (ALTO) |
| twice | P 9 |
| 3 times | P 8 |
| 4 times | P 7 (MEDIO-ALTO) |
| 5 times | P 6 (MEDIO) |
| 6 times | P 5 |
| 7 times | P 4 |
| 8 times | P 3 (MEDIO-BAJO/Decongelación) |
| 9 times | P 2 |
| 10 times | P 1 (BAJO) |

NOTAS:

- Para la cocción de más de una etapa, repetir los pasos, 1 y 2 para cada etapa de cocción antes de presionar la tecla **Start** (Encender). El número máximo de etapas es de 5.
- Cuando se selecciona la potencia P10 (ALTO) para la primera etapa, podrá empezar en el paso 2.
- Sonarán dos zumbidos entre cada etapa de la programación. Sonarán cinco zumbidos al final de toda la secuencia.
- Cuando se selecciona la potencia P10 (ALTO) el tiempo máximo es de 30 minutos.
- Para el recalentamiento, utilizar P10 (ALTO) para líquidos, P7 (MEDIO-ALTO) para la mayoría de los alimentos y P6 (MEDIO) para los alimentos densos.
- Para descongelar use P3 (MEDIO-BAJO/Decongelación).

Para Usar el Pulsador de Tocino

Ejemplo: Para cocinar 4 torrijas de Tocino

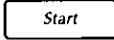
| 1.  Presione 1 vez. | • Ajuste el número de torrijas deseado. | | | | | | | | | | |
|---|---|----------|----------|-------|--|---------|---|---------|--|---------|--|
| | <table border="1"> <thead> <tr> <th>Presione</th> <th>Torrijas</th> </tr> </thead> <tbody> <tr> <td>1 vez</td> <td>4 torrijas (3.2 - 4 onzas) (90 - 110 grs.)</td> </tr> <tr> <td>2 veces</td> <td>6 torrijas (4.8 - 5.8 onzas) (135 - 165 grs.)</td> </tr> <tr> <td>3 veces</td> <td>10 torrijas (8.1 - 9.5 onzas) (230 - 270 grs.)</td> </tr> <tr> <td>4 veces</td> <td>14 torrijas (11.6 - 13 onzas) (330 - 370 grs.)</td> </tr> </tbody> </table> | Presione | Torrijas | 1 vez | 4 torrijas (3.2 - 4 onzas) (90 - 110 grs.) | 2 veces | 6 torrijas (4.8 - 5.8 onzas) (135 - 165 grs.) | 3 veces | 10 torrijas (8.1 - 9.5 onzas) (230 - 270 grs.) | 4 veces | 14 torrijas (11.6 - 13 onzas) (330 - 370 grs.) |
| Presione | Torrijas | | | | | | | | | | |
| 1 vez | 4 torrijas (3.2 - 4 onzas) (90 - 110 grs.) | | | | | | | | | | |
| 2 veces | 6 torrijas (4.8 - 5.8 onzas) (135 - 165 grs.) | | | | | | | | | | |
| 3 veces | 10 torrijas (8.1 - 9.5 onzas) (230 - 270 grs.) | | | | | | | | | | |
| 4 veces | 14 torrijas (11.6 - 13 onzas) (330 - 370 grs.) | | | | | | | | | | |
| 2.  | • Presione el Pulsador Para Comenzar. ► El tiempo de cocción aparecerá en la Pantalla Indicadora y comenzará el conteo regresivo. | | | | | | | | | | |

NOTAS ACERCA DEL PULSADOR DE TOCINO:

- Para mejores resultados, coloque el tocino en un plato rugoso (para tocino). Esto lo mantendrá menos grasoso y ayudará a que se vuelva crujiente.
- Para absorber las salpicaduras de grasa, cubra con papeles absorbentes.
- Si el tocino no es cocinado a su preferencia, continúe la cocción manualmente agregando más tiempo.

Minuto Automático

Esta función le permite ajustar y/o añadir tiempos de cocción fácilmente en múltiplos de un minuto.

Para Ajustar el Tiempo de Cocción:

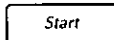
| | |
|--|---|
| 1.  | • Ajustar tiempo de cocción. El nivel de potencia es P10 (ALTO). |
| 2.  Presione | • Presione. ► Comienza la cocción y la Ventana de Visualización realiza una cuenta regresiva. Al final de la cocción, suenan cinco "Beeps". |



NOTAS:

- Para utilizar con otros niveles de potencia, presionar Nivel de Potencia, a continuación minuto Rápido.
- Si utiliza minuto automático, no podrá utilizar pulsador de números o vice versa.
- Pulsar minuto automático para añadir más tiempo durante la cocción. Para verificar el tiempo de cocción adicional, comprobar la **Ventana de Visualización**.

Palomitas de maíz

Para usar con bolsas de palomitas de maíz para horno de microondas:

Ejemplo: Para cocinar un paquete de 50 g de palomitas de maíz .

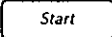
| | |
|--|---|
| 1.  Presione una vez | • Verificar el peso del paquete. |
| 2.  Opcional | |
| 3.  Presione | • Presione el Pulsador Para Comenzar. ►El tiempo de cocción aparecerá en la Pantalla Indicadora y comenzará el conteo regresivo. |

| Pulsar tecla de de Palomitas de Maíz | Paquete de Palomitas de Maíz | Tiempo |
|--------------------------------------|------------------------------|--|
| una vez | 1,75 oz (50 g) | variará dependiendo del tamaño y potencia del horno. |
| dos veces | 2,65 oz (75 g) | |
| 3 veces | 2,85 oz (80 g) | |
| 4 veces | 3,0 oz (85 g) | |
| 5 veces | 3,5 oz (99 g) | |

NOTAS:

1. Los paquetes de palomitas de maíz deberían estar a temperatura ambiente.
2. Colocar la bolsa de acuerdo con las instrucciones del fabricante.
3. Cocinar las bolsa una a una.
4. Una vez que las palomitas estén ya cocinadas, permitir que la bolsa se enfríe. Abrir cuidadosamente la bolsa, manteniéndola apartada de la cara y del cuerpo, ya que las palomitas y el vapor están extremadamente calientes.
5. **NUNCA deje el horno sin atención cuando prepare palomitas de maíz.**
6. No recalentar nunca granos que no se hayan convertido en palomitas ni reutilizar la bolsa. Para el horno de microondas cuandolas palomitas de maíz brinquen a Lentaments de 2 a 3 segundos si se sobrecocinan. Puede quemarse.
7. Debido a la gran variedad de palomitas de maíz para microondas en el mercado, tal vez sea necesario poner la bolsa en la orilla del plato giratorio para obtener mejores resultados.

Notas:

Cuando ponemos varias bolsas de palomitas de maíz una detras de la otra, el tiempo de cocción podría bariar minimamente. Esto no afectara los resultados.

Para usar el Pulsador de Más/Meno

Para Palomitas de Maíz:

Cuando se usa el Pulsador de palomitas de maíz, puede que el peso difiera del ofrecido. Mediante el uso del Pulsador de más/menos, los programas pueden ser ajustados para cocinar la comida por un tiempo más largo o más corto o para un mayor o menor peso.

- 1 pulsación = Más+ Cocción
- 2 pulsaciones = Más++ Cocción
- 3 pulsaciones = Menos- Cocción
- 4 pulsaciones = Menos-- Cocción
- 5 pulsaciones = ajuste original















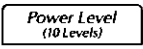

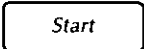









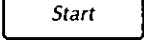

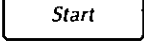



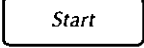





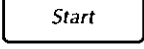

Para el Recalentamiento/ Cocción por Sensor:

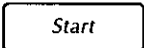
Las preferencias para el punto de cocción varían de acuerdo a la persona. Luego de haber usado el Sensor de Cocción unas pocas veces, podrá decidir si prefiere que su comida sea cocinada en un punto de cocción diferente.







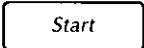





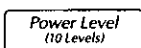



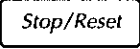

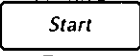



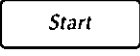

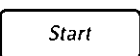

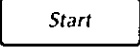
- 1 pulsación = Más+ Cocción
- 2 pulsaciones = Menos- Cocción
- 3 pulsaciones = ajuste original

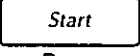
Presione el Pulsador de más/menos antes de presionar el Pulsador Para Comenzar.

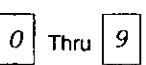
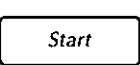
GUIA RAPIDA DE OPERACIÓN

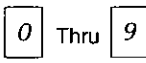
| Característica | Como Opera | | |
|---|--|---|--|
| Para Poner el Reloj en la Hora |  →  a  →  Presione. Registre la hora o día. Presione. | | |
| Para Ajuste de Potencia y Tiempo |  →  a  →  Seleccione potencia. Establezca el tiempo de cocción.. Presione. | | |
| Seguro Para Niños | <table border="0" style="width: 100%;"> <tr> <td style="width: 50%; text-align: center;"> Para Activar  Presione tres veces </td> <td style="width: 50%; text-align: center;"> Para Desactivar  Presione tres veces </td> </tr> </table> | Para Activar  Presione tres veces | Para Desactivar  Presione tres veces |
| Para Activar  Presione tres veces | Para Desactivar  Presione tres veces | | |
| Para Cocinar usando el Pulsador de Palomitas |  →  →  Registre el peso del paquete. Opcional. Presione. | | |
| Para Cocinar usando el Pulsador de Tocino |  →  Seleccione el porción. Presione. | | |
| Minuto Automático |  →  (hasta a 10) Presione. | | |
| Para Descongelar usando el pulsador Descongelación Turbo Inverter |  →  a  →  Presione. Fije el peso. Presione. | | |
| Para Recalentamiento usando el pulsador Recalentamiento de Sensor |  →  →  Presione. Opcional. Presione. | | |
| Para Cocinar usando el Pulsadores de Cocción de Sensor | Ex.  →  →  Seleccione la categoría deseada. Opcional. Presione. | | |
| Para Usar como en temporizador de cocina |  →  a  →  Presione. Presione. | | |
| Para Establecer el tiempo de Permanencia | (Registre el programa de Cocción deseado.) →  →  a  →  Presione. Presione. | | |
| Para Establecer Inicio de Efecto Retardado |  →  a  → (Registre el programa de Cocción deseado.) →  Presione. Presione. | | |

QUICK GUIDE TO OPERATION

| Feature | How to Operate | | | | | | |
|---|--|---|--|---|--|---|--|
| To Set Clock (☛ page 8) |  | → |  | → |  | | |
| | Press once. | | Enter time of day. | | Press once. | | |
| To Set Power and Time (☛ page 8) |  | → |  | → |  | | |
| | Press to select Power Level | | Set cooking time. | | Press. | | |
| To Use Child Safety Lock (☛ page 9) | To Set:  Press 3 times | | To Cancel  Press 3 times | | | | |
| To Cook using Popcorn Pad (☛ page 9) |  | → |  | → |  | | |
| | Select weight. | | Optional. | | Press. | | |
| To Cook using Bacon Pad (☛ page 10) |  | → |  | | | | |
| | Select number of slices. | | | | Press. | | |
| To Cook using Quick Min Pad (☛ page 10) |  | → |  | | | | |
| | (up to 10 min.) | | | | Press. | | |
| To Defrost using Inverter Turbo Defrost Pad (☛ page 10) |  | → |  | → |  | | |
| | Press. | | Set weight. | | Press. | | |
| To reheat using Sensor Reheat Pad (☛ page 12) |  | → |  | → |  | | |
| | Press. | | Optional. | | Press. | | |
| To Cook using Sensor Cook Pads (☛ page 12) | e.g.  | → |  | → |  | | |
| | Select category. | | Optional. | | Press. | | |
| To Use as a Kitchen Timer (☛ page 15) |  | → |  | → |  | | |
| | Press once. | | | | Press. | | |
| To Set Stand Time (☛ page 15) | (Input up to 4- stage cooking programs.) | → |  | → |  | → |  |
| | | | Press once. | | | | Press. |
| To Set Delay Start (☛ page 15) |  | → |  | → | (Input up to 4- stage cooking programs.) | → |  |
| | Press once. | | | | | | Press. |

Panasonic Consumer Electronics Company, Division of Matsushita Electric Corporation of America
 One Panasonic Way
 Secaucus, New Jersey 07094

Panasonic Sales Company, Division of Matsushita Electric of Puerto Rico, Inc. ("PSC")
 Ave. 65 de Infanteria, Km. 9.5
 San Gabriel Industrial Park,
 Carolina, Puerto Rico 00985

F00035L00AP
 FLE1201-0
 Printed in China