

Panasonic[®]

**Operation Guide and Cookbook
Microwave Oven**

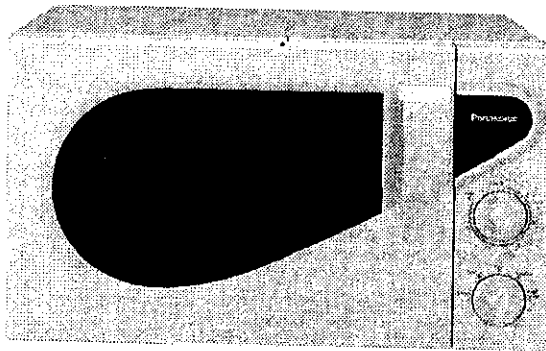

Models **NN-MX25**
NN-MX20

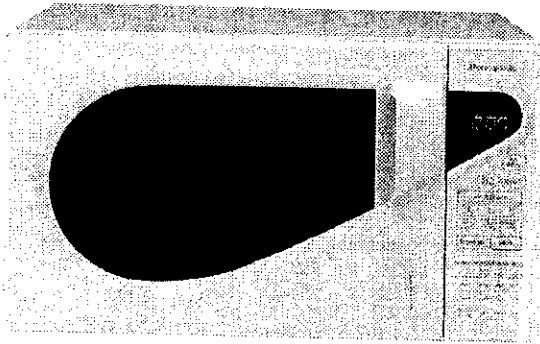
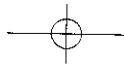

We are glad you have chosen to purchase a PANASONIC microwave oven. Before operating this oven, please read these instructions carefully and completely, and keep them for further reference.

If you have never used a microwave oven before, you will realise that a microwave oven uses a totally different method of converting energy into heat. This requires an understanding of what exactly happens to food when placed in the oven. This is explained in the following pages.

After reading the introductory chapter, I am sure you will be able to master the basic technique and thereby develop a firm understanding of your new oven. This book includes recipes from starters to desserts. After trying our recipes be sure to adapt your favourite recipes to microwave methods.

Start experimenting now, and enjoy the first class results you will achieve by using your new microwave oven.

Consultant
Home Economist
Kyla Italiano
Fiona Campbell

Panasonic Australia Pty. Ltd.
P.O. Box 505
French Forest NSW 1640



PANASONIC NZ LTD
CUSTOMER CARE CENTRE
350 Te Irirangi Drive
East Tamaki, Auckland
Private Bag 14911
Panmure, Auckland

Phone: (09) 272-0178
Fax: (09) 272-0137

Product Manager
NPC Electronics (Ltd)
Panasonic Consumer Company
Head Office - South Africa
Unit 10, Fedlife Park, Tonnetti Street
Halfway House, Midrand
P.O. Box 1198
Halfway House
1685

Tel. No: (011) 313-1400
Fax. No: (011) 313-1456

The serial number of this product may be found on the back side of the oven. You should note the model number and serial number of this oven in the space provided and retain this book as a permanent record of your purchase for future reference.

MODEL NUMBER _____
SERIAL NUMBER _____
DATE OF PURCHASE _____

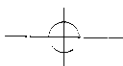

Table of Contents

Before Operation

Safety Instructions	2
Installation and General Instructions	3
Microwaves and How They Work	4
Cookware and Utensil Guide	4-5
Feature Diagram	6
Control Panel	7
Ingredient Conversion Chart	8

Operation and Hints

NN-MX25

To Set Clock	9
To Use Child Safety Lock	9
To Cook by MICRO POWER AND TIME	8
by Auto Cook	14
To Reheat by MICRO POWER AND TIME	8, 11
using AUTO REHEAT Pads	14
To Defrost by MICRO POWER AND TIME	8
using TURBO DEFROST PAD	12
To Use Timer Pad	15
Quick Guide to Operation	33

NN-MX20

To Cook by MICRO POWER AND TIME	10
To Reheat by MICRO POWER AND TIME	10-11
To Defrost by MICRO POWER AND TIME	12-13

Cooking Guide

Microwave Recipe Preparation and Techniques	16-18
Basic Recipes	19
Fish and Shellfish	20
Poultry	21-22
Main Fare Meats	23-24
Vegetable Varieties	25-27
Rice, Pasta and Cereal	28-29
Desserts	30

Maintenance

Before Requesting Service	31
Care of Your Microwave Oven	32
Technical Specifications	32

Safety Instructions

Precautions to be taken when using Microwave Ovens for Heating foodstuffs

INSPECTION FOR DAMAGE. A microwave oven should only be used if an inspection confirms all of the following conditions:

1. The grille is not damaged or broken.
2. The door fits squarely and securely and opens and closes smoothly.
3. The door hinges are in good condition.
4. The metal plates of a metal seal on the door are neither buckled nor deformed.
5. The door seals are neither covered with food nor have large burn marks.

PRECAUTIONS. Microwave radiation from microwave ovens can cause harmful effects if the following precautions are not taken:

1. Never tamper with or deactivate the interlocking devices on the door.
2. Never poke an object, particularly a metal object, through a grille or between the door and the oven while the oven is operating.
3. Never place saucepans, unopened cans or other heavy metal objects in the oven.
4. Do not let other metallic articles, e.g., fast food foil containers, touch the side of the oven.
5. Clean the oven cavity, the door and the seals with water and a mild detergent at regular intervals. Never use any form of abrasive cleaner that may scratch or scour surfaces around the door.
6. Always use the oven with trays or cookware recommended by the manufacturer.
7. Never operate the oven without a load (i.e., an absorbing material such as food or water) in the oven cavity unless specifically allowed in the manufacturer's literature.
8. For horizontally hinged doors, never rest heavy objects such as food containers on the door while it is open.
9. Do not place sealed containers in microwave ovens. Baby bottles fitted with a screw cap or a teat are considered to be sealed containers.
10. The appliance is not intended for use by young children or infirm persons without supervision.
11. Young children should be supervised to ensure that they do not play with the appliance.

Important Instructions

WARNING—To reduce the risk of burns, electric shock, fire, injury to persons or excessive microwave energy:

1. Read all instructions before using the microwave oven.
2. Some products such as whole eggs and sealed containers - (for example, closed glass jars and sealed baby bottles with teat) - may explode and should not be heated in the microwave oven.
3. Use this microwave oven only for its intended use as described in this manual.
4. As with any appliance, close supervision is necessary when used by children.
5. Do not operate this microwave oven if it is not working properly or if it has been damaged or dropped.

6. To reduce the risk of fire in the oven cavity:
 - (a) Do not overcook food. Carefully attend microwave oven if paper, plastic, or other combustible materials are placed inside the oven to facilitate cooking.
 - (b) Remove wire twist-ties from bags before placing bag in oven.
 - (c) If materials inside the oven should ignite, keep oven door closed, turn oven off at the wall switch, or shut off power at the fuse or circuit breaker panel.

Earthing Instructions

This microwave oven must be earthed. In the event of an electrical short circuit, earthing reduces the risk of electric shock by providing an escape wire for the electric current. This microwave oven is equipped with a cord having an earthing wire with an earthing plug. The plug must be plugged into an outlet that is properly installed and earthed.

WARNING—Improper use of the earthing plug can result in a risk of electric shock.

WE CERTIFY THAT THIS MICROWAVE OVEN HAS BEEN INSPECTED AND COMPLIES WITH THE REQUIREMENTS OF REGULATION 3, SUBCLAUSE(2), OF THE MICROWAVE OVENS REGULATIONS 1982.
MATSUSHITA ELECTRICAL INDUSTRIAL CO.,LTD.

(This statement applicable only to New Zealand.)

We certify that this microwave oven has been inspected and complies with the safety requirements of government notice 466 of March 1981, and complies with the Radio Regulation of government notice 587 of March 1986.

(This statement applicable only to South Africa)

WARNING

- a) The door seals and door seal areas should be cleaned with a damp cloth. The appliance should be inspected for damage to the door seals and door seal areas and if these areas are damaged the appliance should not be operated until it has been repaired by a qualified service technician trained by the manufacturer.
- b) It is dangerous for anyone other than a qualified service technician trained by the manufacturer to perform repair services.
- c) If the supply cord of this appliance is damaged, it must be replaced by a qualified service technician with the special cord available only from the manufacturer.
- d) Before use, the user should check that utensils are suitable for use in microwave ovens.
- e) Liquids or other foods must not be heated in sealed containers since they are liable to explode.
- f) Only allow children to use the oven without supervision when adequate instructions have been given so that the child is able to use the oven in a safe way and understands the hazards of improper use.

Installation and General Instructions

General Use

1. In order to maintain high quality, do not operate the oven when empty. The microwave energy will reflect continuously throughout the oven if no food or water is present to absorb energy.
2. If smoke is observed, press the **Stop/Reset Pad** and leave door closed in order to stifle any flames. Disconnect the power cord, and/or shut off power at the fuse or circuit breaker panel.
3. Do not dry clothes, newspapers or other materials in oven. They may catch on fire.
4. Do not use recycled paper products, unless the paper product is labelled as safe for microwave oven use. Recycled paper products may contain impurities which may cause sparks and/or fires when used.
5. Do not use newspapers or paper bags for cooking.
6. Do not hit or strike the Control Panel. Damage to controls may occur.
7. **POT HOLDERS** may be needed as heat from food is transferred to the cooking container and from the container to the Glass Tray. The Glass Tray can be very hot after removing the cooking container from the oven.
8. Do not store flammable materials next to, on top of, or in the oven. It could be a fire hazard.
9. Do not cook food directly on Glass Tray unless indicated in recipes. (Food should be placed in a suitable cooking utensil.)
10. **DO NOT** use this oven to heat chemicals or other non-food products. **DO NOT** clean this oven with any product that is labelled as containing corrosive chemicals. **The heating of corrosive chemicals in this oven may cause microwave radiation leaks.**

Placement of Oven

1. The oven must be placed on a flat, stable surface. For correct operation, the oven must have sufficient air flow. **Allow 15 cm of space on the top of the oven, 10 cm at the back, and 5 cm on both sides. If one side of the oven is placed flush to wall, the other side or top must not be blocked. Do not remove feet.**
 - a. Do not block air vents. If they are blocked during operation, the oven may overheat. The oven will remain inoperable until it has cooled.
 - b. Do not place oven near a hot or damp surface such as a gas stove, electric range or sink etc.
 - c. Do not operate oven when room humidity is too high.
2. This oven was manufactured for household use only.

Circuits

Your microwave oven should be operated on a separate 10 A circuit from other appliances. Failure to do this may cause the power board fuse to blow, and/or food to cook slower. Do not insert higher value fuse in the power board.

Food

1. Do not use your oven for home canning or the heating of any closed jar. Pressure will build up and the jar may explode. In addition, the microwave oven cannot maintain the food at the correct canning temperature. Improperly canned food may spoil and be dangerous to consume.
2. Do not attempt to deep fat fry in your microwave oven.
3. Do not boil eggs in their shell and whole hard-boiled eggs (unless otherwise stated in Cooking Guide section). Pressure will build up and the eggs will explode.
4. Potatoes, apples, egg yolks, whole squash and sausages are examples of foods with nonporous skins. This type of food must be pierced before cooking, to prevent bursting.
5. When heating liquids, e.g. soup, sauces and beverages, in your microwave oven, overheating the liquid beyond boiling point can occur without evidence of bubbling. This could result in a sudden boil over of hot liquid. To prevent this possibility the following steps should be taken:
 - a) Avoid using straight-sided containers with narrow necks.
 - b) Do not overheat.
 - c) Stir the liquid before placing the container in the oven and halfway through cooking time.
 - d) After heating, allow to stand in the oven for a short time, stirring again before carefully removing the container.
6. **DO NOT USE A CONVENTIONAL MEAT THERMOMETER IN THE MICROWAVE OVEN. To check the degree of cooking of roasts and poultry use a MICROWAVE THERMOMETER.** Alternatively, a conventional meat thermometer may be used after the food is removed from the oven. If undercooked, return meat or poultry to the oven and cook for a few more minutes at the recommended power level. It is important to ensure that meat and poultry are thoroughly cooked.
7. **COOKING TIMES given in the Cooking Guide section are APPROXIMATE.** Factors that may affect cooking time are preferred degree of moisture content, starting temperature, altitude, volume, size, shape of food and utensils used. As you become familiar with the oven, you will be able to adjust for these factors.
8. **It is better to UNDERCOOK RATHER THAN OVERCOOK foods.** If food is undercooked, it can always be returned to the oven for further cooking. If food is overcooked, nothing can be done. Always start with minimum cooking times recommended.
9. Extreme care should be taken when cooking popcorn in a microwave oven. Cook for minimum time as recommended by manufacturer. Use the directions suitable for the wattage of your microwave oven. **NEVER** leave oven unattended when popping popcorn.
10. When heating food in plastic or paper containers, check the oven frequently due to the possibility of ignition.
11. The contents of feeding bottles and baby food jars are to be stirred or shaken and the temperature is to be checked before consumption, in order to avoid burns.

Microwaves and How They Work

Microwaves are a form of high frequency radio waves similar to those used by a radio, including AM, FM and CB. They are similar to a television where the radio waves are converted to a picture on the screen. However, microwaves are much shorter than radio waves; approximately twelve centimetres wave length. Electricity is converted into microwave energy by the magnetron tube (which is the heart of the microwave oven).

From the magnetron tube, microwave energy is transmitted to the oven cavity through a small plastic covered piece. The microwaves are converted to heat in the food. The microwaves enter from the outside of the food and travel through the food losing half of their power every two to three centimetres. Continued cooking to the centre occurs by conduction.

Although pacemakers used to be affected by microwaves (as well as by other radio waves), they are now shielded and are not bothered by these interferences. This allows people with pacemakers to sit calmly by their radio or television and cook with microwave ovens.

When microwaves come in contact with a substance, any one or combination of three things may occur.

They can be:

1. REFLECTED
2. TRANSMITTED
3. ABSORBED

Reflection:

Metal substances REFLECT microwave energy and because there is no absorption, there is no heating. This is why the oven interior is either stainless steel or epoxy-coated steel. This ensures that the microwaves are kept inside the cavity and evenly distributed throughout the food with the help of the turntable.

Transmission:

Such substances as paper, glass and plastic TRANSMIT microwave energy and do not become hot except from food. Because these substances do not reflect or absorb microwave energy, they are ideal materials for microwave cooking containers.

Absorption:

Food contains moisture and will ABSORB microwave energy, which causes the moisture molecules within the food to vibrate at an incredible rate (2,450,000,000 times per second). Friction, created by the vibration, produces heat energy which is conducted throughout the food.

Cookware and Utensil Guide

It is important to use the correct container when cooking in a microwave oven. The following will help you make the right selection.

How to Test a Container for Safe Microwave Oven Use

Fill a 1-cup glass measure with water and place it in the microwave oven along with the container to be tested. Heat one minute on **HIGH**. If the container is microwave oven safe, it should remain comfortably cool and the water should be hot. If the container becomes very hot, it has absorbed some microwave energy and should not be used. This test cannot be used for plastic containers.

Paper Products and Freezer Wrap

Waxed paper, paper plates, cups and napkins should not be used for heating or cooking food. Freezer wrap should not be used as it is not heat resistant and may melt. Paper towel, greaseproof paper and bake paper may be safely used for short periods of time for covering or lining.

Glass, Ceramic and China

Heat-Resistant glass cookware is invaluable in microwave cooking. Many of these items are readily available in most homes: glass jugs, mixing bowls, loaf dishes, covered casseroles, oblong baking dishes, pie plates and round or square cake dishes. Examples of this type of cookware are Pyrex® and Corningware®.

Dinnerware can be used for microwave heating. Many brands of dinnerware are microwave safe. Check the care information for reference to microwave use for dinnerware and serving pieces. If dinnerware is marked ovenproof, it frequently is safe to use in the microwave oven. However, to be sure, check by conducting microwave dish test previously mentioned.

Several types of glassware and dinnerware are not recommended for use in the microwave oven. Do not use dishes with metallic trim or containers with metal parts. Do not use cups or mugs with glued on handles, as they may fall off with continued heating. Do not use delicate glassware. Although the glassware may be transparent to microwave energy the heat from the food may cause the glassware to crack.

Cookware and Utensil Guide *(continued)*

Plastics

Plastic dishes, cups and some freezer containers should be used with care in a microwave oven. Choose plastic containers carefully, as some plastic containers may become soft, melt and may scorch. The majority of plastic dishes, even those designed for use in the microwave oven, are not suitable for cooking foods with high fat or sugar content, or for lengthy cooking times. Most microwave plastic dishes should not be used for longer than 3 to 5 minutes on HIGH power. These dishes, although not suitable for extended cooking, may be used successfully for defrosting or for use on lower power levels.

Cooking Bags designed to withstand boiling, freezing, or conventional heating are microwave safe. Prepare bags according to manufacturer's directions. When cooking by microwave, **DO NOT** use wire twist-ties to close bag. They can act as an antenna and cause arcing (sparks).

DO NOT COOK IN PLASTIC FOOD STORAGE BAGS.

Plastic Wrap such as GLAD WRAP® can be used to cover dishes in most recipes. Over an extended heating time, some disfiguration of the wrap may occur. When removing plastic wrap "covers", as well as any glass lid, be careful to remove it away from you to avoid steam burns.

Loosen plastic but let dish stand, covered.

Browning Dishes

Browning dishes are used to sear chops, meat patties, steaks, etc.. A special coating on the bottom of the dish absorbs the microwave energy and becomes very hot. When foods are added to the dish, the result is a seared effect. Preheat the dish according to the manufacturer's directions. Add food to be seared and heat according to recipe or personal preference.

Use pot holders to remove the dish from the microwave oven. Do not use the browning dish on or in a conventional stove.

Remember:

Food can be covered with a loose sheet of absorbent towel to prevent splattering. Do not attempt to deep fry in the browning dish or microwave oven as you cannot control the temperature of the oil.

Note:

Browning dishes may no longer be available. This information is being supplied to assist people who own browning dishes.

Metal

Metal cookware or utensils, or those with metallic trim, should **NOT** be used in the microwave. Since microwave energy is reflected by metal, foods in metal containers will not cook evenly. There is also a possibility of "arcing."

Although metal utensils should be avoided in microwave cooking, some metal can be helpful when used correctly.

Aluminum foil can be used safely, if certain guidelines are followed, to prevent overcooking. Small pieces of foil are used to shield areas such as chicken wings, tips of roasts, or other thin parts that cook before the rest of the recipe is finished. Make sure foil is attached securely and doesn't touch sides of oven, otherwise arcing may occur. Foil lined containers, either cardboard or plastic, should **NOT** be used in the microwave oven as arcing could occur.

Metal twist-ties, either paper or plastic coated, should **NOT** be used in the microwave oven. Frozen dinner trays can be used in the microwave, if the container is no deeper than 2 cm and is filled with food. Metal skewers can not be used in microwave ovens as arcing may occur. Wooden skewers are readily available and give the same result.

Shells: Scalloped baking shells are best used during reheating and for short periods of cooking time only.

Thermometers are available for use in microwave ovens. **DO NOT USE CONVENTIONAL MERCURY TYPE CANDY OR MEAT THERMOMETERS** in food while cooking in the microwave oven.

Jars and Bottles

Jars and bottles can be used to warm food to serving temperature, if the lid is removed first. Cooking should not be done in these containers since most are not heat resistant and during extended heating times, heat from food would cause cracking or breaking.

Straw, Wicker and Wood

Straw and wicker baskets may be used in the microwave oven for short periods of time to warm rolls or bread. Large wooden utensils, such as bowls or cutting boards should **NOT** be used for prolonged heating as the microwave energy may cause the wood to become dry and brittle.

Feature Diagram

Glass Tray

1. Do not operate the oven without the Roller Ring and Glass Tray in place.
2. Only use the Glass Tray specifically designed for this oven. Do not substitute another Glass Tray.
3. If Glass Tray is hot, allow to cool before cleaning or placing in water.
4. **Do not** cook directly on Glass Tray. Always place food on a microwave-safe dish, or on a rack set in a microwave-safe dish.
5. If food or utensil on Glass Tray touches oven walls, causing the tray to stop moving, the tray will automatically rotate in opposite direction. This is normal.
6. Glass Tray can rotate in either direction.

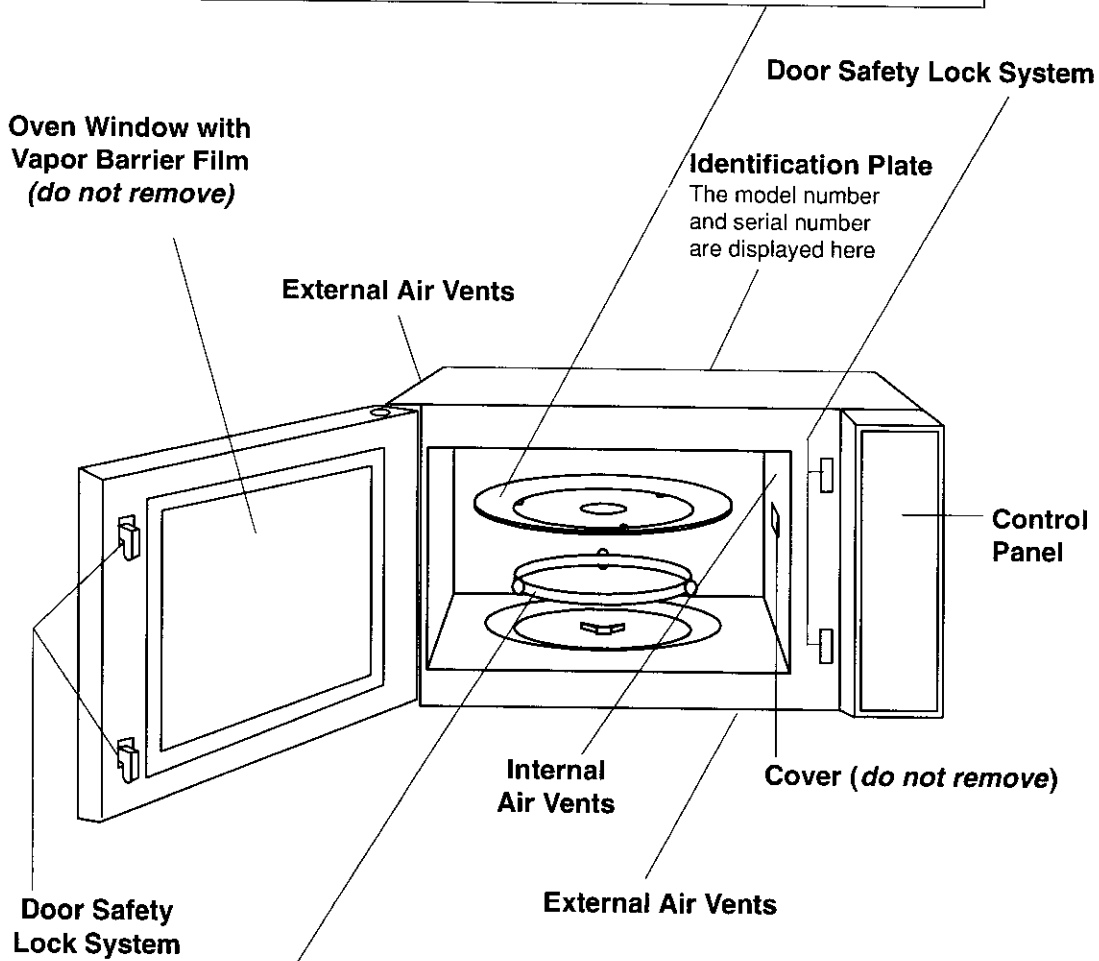

Roller Ring

1. The Roller Ring and oven floor should be cleaned frequently to prevent excessive noise.
2. The Roller Ring must always be used together with the Glass Tray for cooking.

Control Panel

NN-MX25

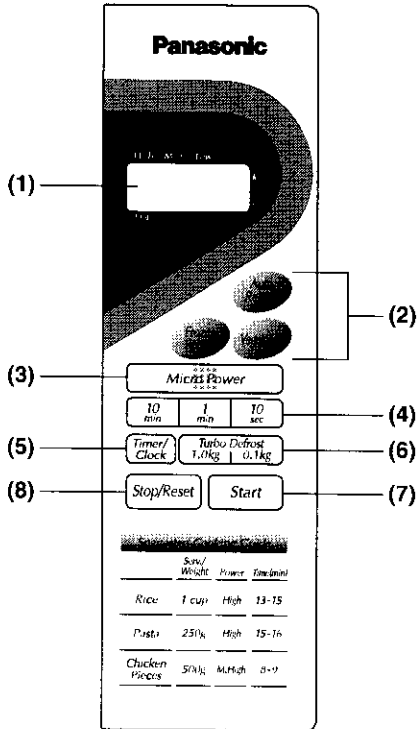

- (1) Display Window
- (2) Auto Cook Pads
- (3) Micro Power Pad
- (4) Time Pads
- (5) Timer/Clock Pad
- (6) Turbo Defrost Pad
- (7) Start Pad

One tap allows oven to begin functioning. If door is opened or **Stop/Reset** Pad is pressed once during oven operation, **Start** Pad must again be pressed to restart oven.

(8) Stop/Reset Pad

Before cooking: One tap clears your instructions.

During cooking: One tap temporarily stops the cooking process. Another tap cancels all your instructions and time of day appears in the Display Window.

Beep Sound

When a pad is pressed correctly, a beep will be heard. If a pad is pressed and no beep is heard, the unit did not or could not accept the instruction. The oven will beep twice between programmed stages. At the end of any completed program, the oven will beep 5 times.

NN-MX20

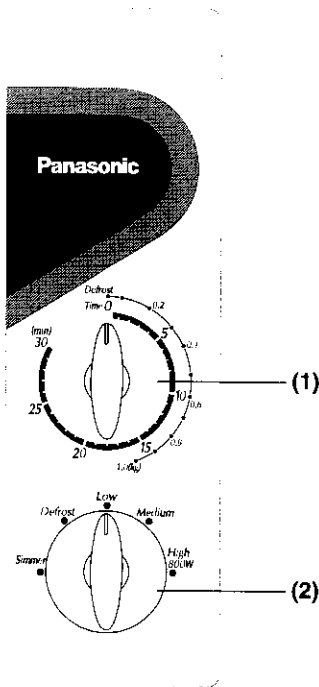

- (1) Timer/Weight Select Dial
- (2) Micro Power Select Dial

NOTE:

As soon as the TIMER/WEIGHT SELECT DIAL is turned, the oven will start cooking the food.

ALWAYS RETURN TIMER/WEIGHT SELECT DIAL BACK TO ZERO position if food is removed from oven before set cooking time is complete and when oven is not in use.

TO STOP OVEN when a cooking program is set, open the door, microwaves automatically stop entering the oven cavity because of the safety door lock system. If the remaining cooking time is not required, turn the Timer/Weight Select Dial back to zero position before closing the door.

To Cook / Reheat / Defrost by **Micro Power and Time** (for NN-MX25)

To Cook/Reheat/Defrost by Micro Power and Time

1 Plug in

Plug into a properly earthed electrical outlet.

2 Open Door

Open the door and place container with food in a dish on Glass Tray in the oven. Then close the door.

3 Select Power Level

Press Micro Power pad to your desired power level.
To select MEDIUM power press Micro Power pad 4 times.

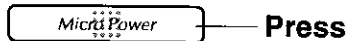

Note: When selecting High Power on the first stage, you can start from step 4.

4 Set Time (e.g. 1 minute 30 seconds)

Press Time Pad

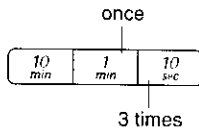

Note: For High Power, up to 30 minutes. For other Power, up to 99 minutes and 90 seconds for a single stage.

5 Press

Verify your selection(s) in the Display Window.

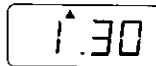

Two/Three stage cooking:

Repeat steps 3 & 4 above then press **Start** Pad, the oven will beep twice between stages and five times at the end of cooking.

e.g. Casserole – (HIGH, 10 minutes) to bring to a boil – then (MED-HIGH, 30 minutes) to finish by simmering.
Stage 1 Stage 2

Micro Power:

The **Micro Power** Pad gives you a selection of different power levels representing decreasing amounts of microwave energy used for cooking foods at different speeds. To select the correct power level for cooking different foods, refer to the chart below.

PRESS MICRO POWER	POWER LEVEL	POWER	EXAMPLE OF USE
1X	HIGH	100%	Boil water. Cook fresh fruit, vegetables, rice, pasta and noodles.
2X	DEFROST	30%	Thaw foods.
3X	MEDIUM-HIGH	70%	Cook poultry, meat, cakes, desserts. Heat milk.
4X	MEDIUM	55%	Cook pot roasts, casseroles and meatloaves, melt chocolate. Cook eggs and cheeses. Cook fish.
5X	LOW	10%	Keep cooked foods warm, simmer slowly.

To Set Clock (for NN-MX25)

You can use the oven without setting the clock.

1 Press twice

The colon start to blink.

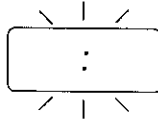

2 Enter Time of Day

Enter time of day by pressing appropriate Time Pads.
e.g. 11:25

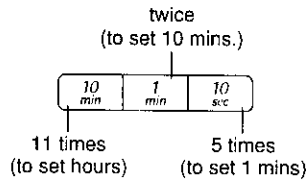

Time appears in the Display Window, colon is blinking.
Verify time of day in the Display Window.

3 Press

The colon stops blinking; time of day is now locked into Display Window.

NOTES: Oven will not operate while colon is still blinking

1. To reset time of day, repeat step 1 through 3.
2. The clock will keep the time of day as long as oven is plugged in and electricity is supplied.
3. This is a 12 hour clock, ie 2pm = 2:00 not 14:00

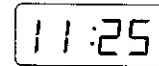

To Use Child Safety Lock (for NN-MX25)

This feature allows you to prevent operation of the oven by a young child; however, the door will open.
You can set Child Safety Lock when colon or time of day is displayed.

To set:

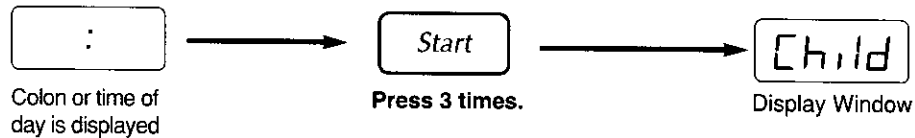

To cancel:



To Cook / Reheat / Defrost by **Micro Power and Time** (for NN-MX20)

1 Plug in

Plug into a properly earthed electrical outlet.

2 Open Door

Open the door and place container with food in a dish on Glass Tray in the oven. Then close the door.

3 Select Power Level (see chart in page 8)

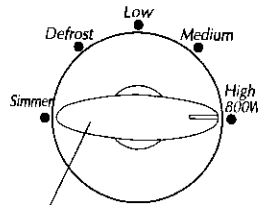

Set the Power Level.

4 Set Cooking Time (e.g. 5 minutes)

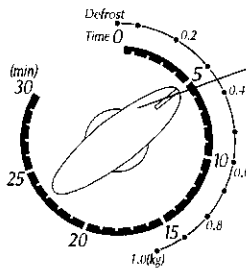

Set the working time.

NB: When selecting the time for shorter than 5 minutes, turn Timer/Weight Select Dial past 5 minutes and then return to the correct time.

INGREDIENT CONVERSION CHART*

1/4 cup	60 ml	1/4 teaspoon	1 ml
1/3 cup	85 ml	1/2 teaspoon	2 ml
1/2 cup	125 ml	1 teaspoon	5 ml
2/3 cup	165 ml	2 teaspoons	10 ml
3/4 cup	190 ml	3 teaspoons	15 ml
1 cup	250 ml	1 tablespoon	15 ml
1 1/4 cups	310 ml	1 1/2 tbs	22 ml
1 1/2 cups	375 ml	2 tbs	30 ml
2 cups	500 ml	3 tbs	45 ml
3 cups	750 ml	4 tablespoons	60 ml
3 1/2 cups	875 ml		
4 cups	1 litre		
6 cups	1.5 litre		
8 cups	2 litre		

*Applicable to New Zealand.

To Reheat by Micro Power and Time

Reheat by Setting Power and Time - Frozen Convenience Foods

FROZEN ITEM (Pre-cooked)	POWER	TIME (in minutes)	SPECIAL INSTRUCTIONS
BREAD & BAKED PRODUCT Bread 1 slice 1 loaf 6 rolls	MEDIUM-HIGH MEDIUM-HIGH MEDIUM	10 - 15 sec 2 - 4 1 - 2	Do not let bread get hot, or it will become rubbery and dry out. Remove whole loaf from original wrapper. Place on paper towel to absorb moisture.
Cheesecake (600 g)	DEFROST	2 - 3	Remove from container. Defrost on plate.
Muffins - 4 (350 g)	MEDIUM-HIGH	4 - 6	Place onto paper towel lined plate.
Scones - 6 (400 g)	MEDIUM	1 - 2	Defrost on paper lined plate. Stand 2 minutes.
PIES Fruit Pie (500 g)	DEFROST then MEDIUM-HIGH	6 - 8 6 - 8	Remove from foil container and place uncovered into a pie dish.
Meat Pie (300 g)	DEFROST then MEDIUM	4 - 6 2 - 3	Place onto paper towel lined plate.
Pizza (350 g)	HIGH	5 - 7	Remove from package and place onto paper towel or follow manufacturer's instructions.
FROZEN MEAL Fish in Sauce (200 g)	MEDIUM	6 - 7	Pierce corner of bag. Heat on a plate.
Instant Casserole in Pouch (serves 2)	MEDIUM	4 - 6	Pierce pouch. Heat on a plate or bowl.
Lasagne (300 g)	MEDIUM	10 - 12	Remove from foil container, place into serving dish.
Plate Food	DEFROST then MEDIUM-HIGH	3 - 4 3 - 4	Arrange food evenly on a dinner plate. Add butter or gravy where desired. Cover plate with plastic wrap.
TV style dinner (400 g)	MEDIUM	8 - 10	Remove foil cover and replace with plastic wrap.
Vegetables & Sauce (in the bag) (400 g)	MEDIUM	8 - 10	Pierce corner of bag. Heat on a plate.
MISCELLANEOUS Chicken Pieces (500 g)	DEFROST then MEDIUM-HIGH	5 - 7 6 - 8	Place onto paper towel lined plate.
Croissants - 4 (250 g)	MEDIUM	2 - 3	Place onto paper towel lined plate.
Fish Fingers - 8 (200 g)	DEFROST then HIGH	3 - 5 2 - 3	Place onto paper towel lined plate.
Sausage Rolls (250 g)	MEDIUM	3 - 5	Place onto paper towel lined plate.

To Defrost

Turbo Defrost (For NN-MX25)

This feature allows you to defrost meat, poultry and seafood by weight.

1 Set Weight

The shape and size of the food will determine the maximum weight the oven can accommodate. The recommended maximum weight of food depends on the oven cavity size. Weight must be programmed in kilograms and tenths of a kilogram (max 2.0 kg).

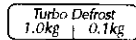

Enter weight.

2 Press



Defrost time appears in the Display Window and begins to count down. Halfway through defrosting, beep sounds. Turn over, rearrange foods, remove defrost areas or shield with aluminum foil.

NOTES:

- Stand time or power level may be programmed after Turbo Defrost (See pages 8 and 15).
- The oven will beep $\frac{1}{3}$ and $\frac{2}{3}$'s of the total defrosting time.
At "beep", turn over all meat, poultry, fish and shellfish. Break apart stewing meat, chicken pieces and minced meat. Separate chops and hamburger patties. Remove defrosted minced meat, stewing meat, poultry pieces or prawns etc. Shield thin ends of roasts, poultry legs and wings, fat or bones with foil.

Defrost by Micro Power and Time Setting

This feature allows you to defrost meat, poultry and seafood by power and time.

For NN-MX25



• Press twice.

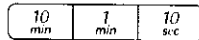
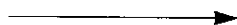

• Set time according to chart on page 13.

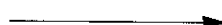

• Press.

For NN-MX20

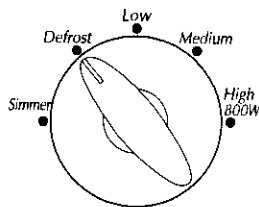

• Set the Power Level at DEFROST.

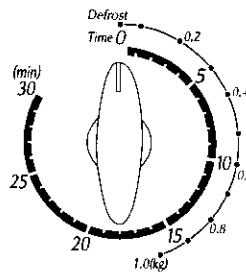

• Set the weight of food.

NB: When selecting weight for less than 0.2 kg, turn Timer/Weight Select Dial past 0.2 kg and then return to correct weight.

Defrosting Tips and Techniques

Preparation for Freezing:

1. Heavy-duty plastic wraps, bags and freezer wrap are suitable.
2. Freeze meats, poultry and fish in packages with only 1 or 2 layers of food. To aid in separating layers, place two pieces of wax paper between them.
3. REMOVE ALL AIR and seal securely.
4. LABEL package with type and cut of meat, date and weight.
5. Defrosting times given in the charts are for thoroughly frozen foods (i.e. at least 24 hours in freezer maintained at -18°C or lower).

Defrosting Technique:

1. Remove from wrapper and set on a roasting rack in a dish on Glass Tray.
2. Throughout the defrosting time, remove any defrosted portions of mince or cubed meat, etc.
3. After defrosting, large roasts may still be icy in the centre. Let stand, 15 to 30 minutes, in refrigerator to complete defrosting.

Defrosting Chart (by setting time):

FOOD	APPROX. TIME (minutes per 500 g)	INSTRUCTION
MEAT		
Beef		
Minced Beef	8 - 11	Halfway through the defrost cycle, break apart minced beef, separate chops and remove meat that is defrosted.
Roast: Topside	12 - 15	
Beef Tenderloin	12 - 15	
Chuck or Rump	10 - 13	Turn meat over two to three times during defrosting.
Sirloin, rolled	11 - 14	
Steak	8 - 10	Shield edges and unevenly shaped ends of roasts halfway through the defrost cycle.
Miscellaneous	8 - 12	
Pork/Lamb		
Roast	9 - 12	Large roasts may still be icy in centre. Let stand.
Chops	8 - 11	
Ribs	8 - 12	
POULTRY		
Chicken		
whole	9 - 12	Turn poultry over two to four times during defrosting. Halfway through the defrost cycle, shield end of drumsticks, wings, breast bones and ends of poultry with foil.
pieces	8 - 11	
fillets	8 - 10	Break apart chicken pieces and remove small pieces such as wings, which may be defrosted before larger pieces.
Duck	10 - 12	
Turkey	10 - 13	Rinse poultry under cold water to remove ice crystals. Let stand 5 to 10 minutes, before cooking.
FISH & SHELLFISH		
Fish Fillets	9 - 11	Halfway through the defrost cycle, turn whole fish or blocks of fillets over. Also, break apart prawns or scallops.
Whole Fish	9 - 12	Remove any pieces that are defrosted.
Crabmeat	8 - 10	
Lobster Tails	8 - 10	
Sea Scallops	8 - 10	Let stand, 5 to 10 minutes, before cooking.
Green Prawns	10 - 12	

To Cook / Reheat Food Using **Auto Cook Pads** (for NN-MX25)

1 Press Desired Food Category Pad until the required weight/serving size appears in the Display Window (see chart below).

e.g. Vegetables
press once - 120 g is displayed
press twice - 180 g



2 Press Start

Cooking time appears in the Display Window and begins to count down.

To Cook using



Pad	Weight			
	1 tap	2 taps	3 taps	4 taps
Auto Reheat	250 g	450 g	650 g	850 g
Frozen Reheat	250 g	450 g	650 g	850 g
Vegetables	120 g	180 g	250 g	370 g

Auto Reheat (250 g - 850 g)

- All foods must be pre-cooked. Suitable for casseroles, plated dinners, soups, stews, pasta dishes (except lasagne), and canned foods.
- Foods should be reheated from room temperature or refrigerator temperature. Do not reheat frozen foods on this setting.
- Foods should be covered loosely but completely with plastic wrap or a casserole lid which does not seal.
- Foods weighting less than 200 g and more than 900 g should be reheated by Micro Power and Time only.
- All foods should have a covered stand time of 3 to 5 minutes at the end of reheating.
- **Do not** reheat bread or pastry products; raw; uncooked or frozen foods; or beverages.
- Halfway through the cooking time, the oven will 'beep' to prompt you to stir or rearrange the foods. At the end of the cooking time, stir and let stand for 3 to 5 minutes.

Frozen Reheat (250 g - 850 g)

- Suitable for reheating pre-cooked soups, stews, casseroles, roast dinners, pasta dishes (except lasagne) and rice dishes from frozen temperature.
- This setting is not suitable for reheating frozen bread or pastry products, raw or uncooked foods or beverages.
- Remove convenience foods from foil or plastic packaging and place in an appropriate size dish.
- Cover dish with plastic wrap or a lid.
- Halfway through the cooking time, the oven will 'beep' to prompt you to stir or rearrange the foods. At the end of the cooking time, stir and let stand for 3 to 5 minutes.

Vegetables (120 g - 370 g)

- Suitable for cooking all types of leaf, green and soft varieties, including broccoli, squash, cauliflower, cabbage, asparagus, beans, celery, zucchini, spinach, capsicum or a mixture of these.
- All vegetables should be trimmed or prepared and cut into even size pieces.
- Add 1 tablespoon to ¼ cup water, if vegetables appear slightly dehydrated. Add water if you prefer a softer cooked texture.
- Place vegetables in an appropriate size dish.
Use the following as a guide:

Weight	Dish Size
120 g	500 ml
180 g	500 ml
250 g	750 ml
370 g	750 ml

- Cover with plastic wrap or a well fitting lid.
- If desired, butter, herbs etc. may be added, but do not add salt until serving. (Salt dehydrates vegetables during cooking).
- Halfway through the cooking time, the oven will 'beep' to prompt you to stir or rearrange the foods. At the end of the cooking time, stir and let stand for 3 to 5 minutes.

To Use Timer Pad (for NN-MX25)

To Use as a Kitchen Timer

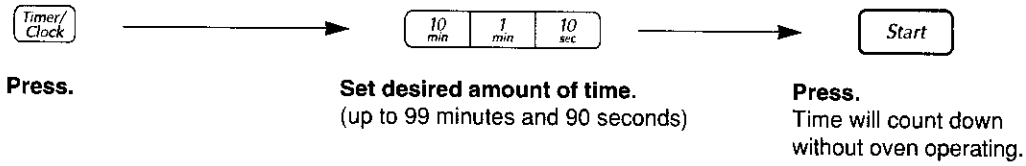

To Set Standing Time

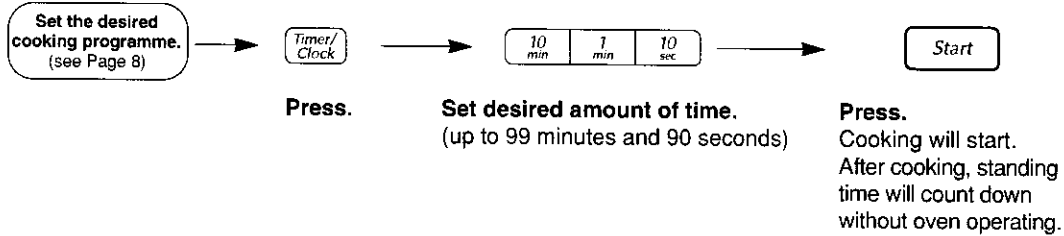

To Set Delay Start

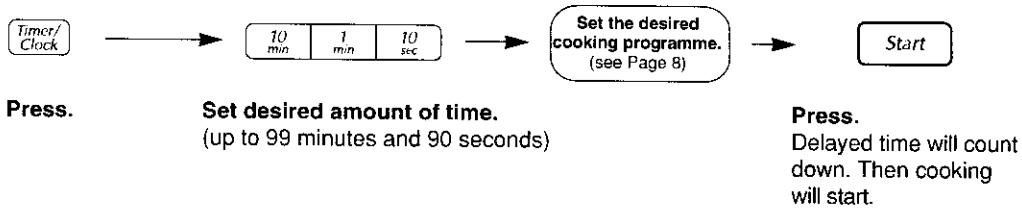

NOTES:

1. If oven door is opened during the Standing Time or Kitchen Timer, the time in the Display Window will continue to count down.
2. Delay Start cannot be programmed before any Auto Control function.
This is to prevent the starting temperature of the food rising before defrosting or cooking begins.
A change in the starting temperature could cause inaccurate results.

Microwave Recipe Preparation and Techniques

Microwaves penetrate the surface of the food to a depth of about two to three centimetres and then the heat is gradually conducted in a random pattern. Some parts of food matter cook faster than others. Special microwave techniques are used to promote

fast and even cooking. Some of these techniques are similar to those used in conventional cooking, but because microwaves produce heat very quickly they are extremely important. It's a must for you to be familiar with the following tips.

Food Characteristics

Size and Quantity

Small portions cook faster than large portions. As you increase the quantity of food you put into the microwave oven, you must also increase your cooking time. The microwave oven has the same power regardless of quantity; thus the power is divided between more items and so it takes longer to cook. As a general guide, if you double the quantity of food suggested in the recipe, add half the time suggested again.

Liquid Content

Low moisture foods take a shorter time to cook than foods with a lot of moisture.

Shape

Uniform sizes cook more evenly. To compensate for irregular shapes, place thin pieces towards the centre of the dish and thicker pieces towards the outer edge of the dish.

Bone and Fat

Bones conduct heat and cause the meat next to them to be heated more quickly. Large amounts of fat absorb microwave energy and the meat next to these areas may overcook.

Starting Temperature

Food which has been sitting at room temperature takes less time to cook than refrigerated or frozen food.

Density and Composition

Porous, airy foods (cakes and breads) take less time to cook than heavy compacted foods (meat and vegetables). Recipes high in fat and sugar content cook more quickly.

Techniques for Preparation

Timing

A range of cooking times is given in each recipe for two reasons. First, to allow for the uncontrollable differences in food shapes, starting temperatures and personal preferences. Secondly, these allow for the differences in electrical voltage input which changes during peak load periods. Always remember that it is easier to add time to undercooked food. Once the food is overcooked, nothing can be done. For each recipe, an approximate cooking time is given.

Stirring

Stirring is often necessary during microwave cooking. We have noted when stirring is helpful in the recipes. Always bring the outside edges towards the centre and the centre portions to the outside.

Rearranging or Turning

Some foods should be turned in the container during cooking. For example, because of the different thicknesses in the breast and back sections of poultry, it is a good idea to turn poultry over once to ensure more even cooking.

Rearranging or turning over uneven shaped food in the dish should be done as suggested to ensure a satisfactory result. Rearrange small items such as chicken pieces, prawns, hamburger patties, steak or chops. Rearrange pieces from the centre to the edge of the dish.

Cooking in Layers

Cooking in layers is not always successful as it takes twice as long to cook a single layer and cooking may be uneven. You can successfully reheat two dinner plates of food at one time but remember to increase the reheating time and use a microwave warming rack.

Piercing of Foods

Pierce the skin or membrane of foods when cooked whole in the microwave oven. This allows steam to escape. If the skin has not been pierced, food may burst.

Cured Meats

Cured meats may overcook in some areas due to the high concentration of salts used in the curing process. So take care when cooking different brands of bacon as cooking times may vary slightly.

Microwave Recipe Preparation and Techniques

Covering

Covering food minimizes the microwave cooking time.

Because microwave cooking is done with time and not direct heat, the rate of evaporation cannot be easily controlled. However, this can be corrected by using different materials to cover dishes. Plastic wrap is the best substitute for a lid as it creates a tighter seal and so it retains more heat and steam. Wax paper and paper towels hold the heat in but not the steam. These materials also prevent splattering. Use a paper towel, wax paper or no cover when steam is not needed for tenderising.

Browning

Meats and poultry, when cooked longer than 10 to 15 minutes, will brown from their own fat. Foods cooked for shorter periods of time can be aided with the help of a browning sauce, worcestershire sauce or soy sauce. Simply brush one of these sauces over meat or poultry before cooking. Baked goods do not need long cooking time and therefore, do not brown. When cakes or cupcakes are iced, no one will notice the visual difference. For cakes or cupcakes, brown sugar can be used in the recipe in place of caster sugar or the surface can be sprinkled with dark spices before baking.

Standing Time

The moisture molecules continue to vibrate in the food when the microwave oven has turned itself off. After all, the molecules were vibrating at 2,450,000,000 times per second during cooking. So cooking continues even after the food is no longer being exposed to the microwaves whether in or outside your microwave oven.

Standing time refers to the time it takes (after the microwave time is completed) to allow the interior of the food to finish cooking.

The amount of standing time varies with the size and density of the food. In meat cookery, the internal temperature will rise between 5°C and 10°C if allowed to stand covered for ten to fifteen minutes. Casseroles and vegetables need shorter standing time, but this time is necessary to allow foods to complete cooking in the centre without overcooking on the edges.

The power level used in microwave cooking also determines the standing time. For example, when using a lower power level the standing time is shorter because of a lower concentration of heat in the food. Foods should always be kept covered while standing in order to retain the heat. If a longer standing time is required (while you cook another food to serve with the first, for instance), cover with aluminum foil.

Converting Your Favourite Conventional Recipes for Microwave Cooking

When adapting conventional recipes for microwave cooking, reduce the conventional cooking time by one quarter or one third.

e.g. A chicken which takes 1 hour to cook in a moderate oven will take 15 to 20 minutes on MEDIUM Power in your microwave oven.

Use similar microwave recipes to help you adapt conventional recipes. Remember, it is always best to undercook a recipe and then add an extra minute or two to finish it off.

Here are some other tips that may help:

- Reduce liquids in a conventional recipe by one half to two thirds, e.g. 1 cup (250 ml) should be reduced to ½ cup (125 ml).
- Add more thickening such as flour or cornflour to sauces and gravies if you do not reduce the liquid.
- Reduce seasonings slightly in a recipe where ingredients do not have time to simmer by microwave.
- Do not salt meats, poultry or vegetables before cooking; otherwise, they will toughen and dry out.
- If one ingredient takes longer to cook than the others, precook it in the microwave oven first. Onion, celery and potato are examples.
- If meat or vegetables are not being browned before cooking, omit any oil or fat that would have been used for browning.
- Reduce leavening agents for cakes by one quarter and increase liquids by one quarter.
- Biscuits require a stiff dough. Increase flour by about 20 percent. Substitute brown sugar for white sugar and use biscuit recipes that have dark spices or require icing. Because of the short cooking time, biscuits don't have to brown. Chill dough for half an hour before baking. This produces a crisper biscuit. Bake biscuits on a glass tray lined with greaseproof paper.
- Since microwaves penetrate foods about two centimetres from the top, bottom and sides, mixtures in round shapes and rings cook more evenly. Corners receive more energy and may overcook.
- Items with a lot of water, such as rice and pasta, cook in about the same time as they would on a conventional stove. (Refer to Rice and Pasta chapter.)

Select recipes that convert easily to microwave cooking such as casseroles, stews, baked chicken, fish and vegetable dishes. The results from foods such as grilled meats, cooked souffles or two-crust pies could be less than satisfactory. Never attempt to deep fry in your microwave oven.

Microwave Recipe Techniques

Menu Planning for Microwave Cooking

How to Keep Everything Hot at The Same Time

Plan your meals so that the food will not all need last minute cooking or attention at the same time. The special features of microwave cookery make it easy to serve meals with everything piping hot. Cooking of some foods may be interrupted while you start others, without harming the nutritional value or flavour of either.

A recipe which requires standing time can be microwaved first and another food cooked while it stands. Dishes prepared in advance can be reheated briefly before serving.

It does take some experience and time to cook with confidence. Microwaves are fast so you will have to do some experimenting. You might find you will use your conventional range in conjunction with your microwave oven. For example, while cooking the roast in the microwave oven, you can be cooking the vegetables and gravy on the range top. This can also be done the other way around. Prepare your meals as follows.

1. Firstly, cook the most dense item (roast or casserole). Drain and retain meat juice from joints then cover with foil.
2. Cook the potatoes, rice or pasta.
3. Cover with foil for standing.
4. Cook greens and other vegetables.
5. Cover with foil for standing.
6. Cook the gravy with the retained meat juices, stock and thickening.
7. Carve the roast and serve the vegetables and gravy.

While you are learning to plan meals, you may get a bit behind time. Don't worry. Dinner servings may be suitably reheated on MEDIUM-HIGH, at 2 minutes per serving.

If you prefer not to use foil, cover food with saucepan lids. A metal lid will retain the heat for at least 15 minutes.

Meanwhile, how can you cook all the vegetables at the same time? Simply place potatoes and pumpkin in one dish and less dense vegetables such as broccoli, cabbage, cauliflower, beans and peas in another. Sprinkle greens with water. Cover with a lid or plastic wrap. Cook on HIGH for approximately 6 to 8 minutes for a serving for four people. Remember, if you increase the quantity of vegetables, increase the cooking time. Fresh and frozen vegetables can be mixed on a vegetable platter, but remember the latter are not as dense as fresh vegetables, as they have been blanched before freezing.

If vegetables are cut to a similar size, they can be cooked in separate ramekins or small dishes at the same time.

Increasing & Decreasing Recipes

Increasing

- To increase a recipe from 4 to 6 servings, increase each ingredient listed by half.
- To increase a recipe from 4 to 8 servings, double each ingredient listed.
- For larger quantities of a recipe, a large dish should be used. Make sure that the dish is deep enough to prevent the recipe from boiling over during cooking.
- Make sure to cover, stir or rearrange food as directed in the recipe and always check the food during cooking.
- Increase standing times by 5 minutes per 500g.
- Use the same Power Level recommended in the original recipe.
- Increase the cooking times by: $\frac{1}{3}$ of original cooking time for 6 servings; and an extra $\frac{1}{2}$ of original cooking time for 8 servings.

Decreasing

- To decrease a recipe from 4 to 2 servings, decrease each ingredient listed by half.
- For small quantities, a small dish should be used. Make sure that the dish is large enough to prevent the recipe from boiling over during cooking.
- Use the same Power Level recommended in the original recipe.
- Decrease the cooking times by $\frac{1}{2}$ to $\frac{2}{3}$ of the original cooking time.

Cooking for One

- To decrease a recipe from 4 to 1 serving, quarter each ingredient listed.
- A smaller dish should be used, making sure that the dish is still large enough to prevent the recipe from boiling over.
- Use the same Power Level recommended in the original recipe.
- Quarter the original cooking times, then add extra time, if needed.
- Make sure to cover, stir or rearrange food as directed in original recipe and always check the food during cooking.

Converting Recipes from Other Sources

When the recipe is written with a wattage different than your oven, adjust the cooking time by approximately 10% per 100 watts, e.g. 6 minutes would be adjusted by 36 seconds. Alternately, adjust the power level by one level. If your wattage is higher than the recipe: (1) Adjust time downward or (2) Adjust power level downward. If your wattage is lower than the recipe: (1) adjust time upward or (2) adjust power level upward (when possible).

Everyday Basics

GRANOLA CEREAL

Makes: approximately 4 cups

Ingredients:

2 cups	oats
½ cup	chopped nuts
½ cup	wheat germ
¼ cup	brown sugar
¼ cup	honey
1 teaspoon	vanilla essence
½ cup	raisins
½ cup	coconut

Method:

1. Place oats in 2-litre casserole dish, cook on HIGH for 2 to 3 minutes, stirring twice.
2. Add nuts, wheat germ, and brown sugar. Stir in honey and vanilla. Cook on HIGH for 3 to 5 minutes, stirring twice during cooking.
3. Add raisins, coconut and allow to cool. Stir to a crumble texture. Store in an airtight container.

TOMATO AND ONION

Serves 4

Ingredients:

approx. 3	tomatoes, thinly sliced
1	onion, thinly sliced
½ teaspoon	basil
	salt and pepper to taste

Method:

1. Place all ingredients into 2-litre casserole dish.
2. Cook, covered, on HIGH for 6 to 8 minutes. Serve with barbecued steak or grilled meat.

SCRAMBLED EGGS

Serves: 2

Ingredients:

4 x 61 g	eggs
4 tablespoons	milk
	pinch of salt

Method:

1. In 1-litre casserole dish, beat eggs lightly with whisk. Add milk and salt. Whisk until well combined. Cover dish with plastic wrap and cook on MEDIUM for 2 to 2½ minutes.
2. Stir egg and cook for further 2½ to 3 minutes. Stand, covered, for 1 minute before serving.

HINT:

TO COOK PAPPADUMS:

Place on paper towel lined microwave safe plate. Cook on HIGH for 15 to 20 seconds for each pappadum, turning halfway through cooking. Allow to stand 1 minute before serving.

POACHED EGGS

Serves: 2

Ingredients:

½ cup	hot tap water
	dash of vinegar
	pinch of salt
2 x 61 g	eggs

Method:

1. Place one quarter of a cup of water, dash of vinegar and pinch of salt into 2 ramekin dishes or small glass bowls.
2. Break egg into the water and with toothpick pierce the egg yolk twice and egg white several times.
3. Cover dish with plastic wrap and cook on MEDIUM for 1 to 1½ minutes. Stand, covered, for 1 minute before serving.

Note: The size of the eggs will alter cooking time.

GRAVY

Makes: 2 cups (500 ml)

Ingredients:

2 tablespoons	dripping or pan juice
1	small onion, finely chopped
2 tablespoons	flour
1 tablespoon	tomato paste
1½ cups	beef stock, divided
	salt and pepper

Method:

1. Place dripping or pan juices and onion in 2-cup jug. Cook on HIGH for 2 minutes.
2. Add flour, tomato paste and half of the beef stock. Stir well. Cook on HIGH for 2 minutes. Add remaining stock.
3. Stir well and cook on HIGH for a further 2 minutes. Season with salt and pepper. Serve with the meat of your choice.

BASIC WHITE SAUCE

Makes: 1 cup

Ingredients:

2 tablespoons	butter
2 tablespoons	flour
	salt and white pepper
1¼ cups	milk

Method:

1. Place butter in 4-cup jug. Cook on HIGH for 30 to 40 seconds.
2. Stir in flour, salt and pepper. Gradually add milk, stirring until smooth.
3. Cook on HIGH for 3 to 4 minutes, stirring twice.

Tip: For cheese sauce, stir in ½ cup grated cheese once sauce has thickened.

HINT:

TO COOK BACON RASHERS:

Place bacon between 2 sheets of paper towel on a pie plate and cook on HIGH for 2 to 3 minutes.

HINT:

TO DRY FRESH BREADCRUMBS:

Place 1 cup (250 ml) of breadcrumbs on the base of plate and heat on HIGH for 2 to 3 minutes, stirring once during heating.

Poultry

CHICKEN SAN CHOY BAU

Serves: 4

Ingredients:

10	dried chinese mushrooms
2 teaspoons	sesame oil
1	clove garlic, chopped
500g	minced chicken
10	water chestnuts, finely chopped
125 g	bamboo shoots, chopped
1 tablespoon	soy sauce
2 teaspoons	oyster sauce
2 tablespoons	sherry
1	small iceberge lettuce

Method:

1. Cover mushrooms with boiling water, stand for 30 minutes. Drain, remove stems and chop finely.
2. Place oil and garlic in a 2-litre casserole dish, cook on Medium-High for 50-60 seconds.
3. Add chicken and cook on Medium-High for 8-10 minutes. Add remaining ingredients except lettuce and cook on Medium-High for 5-6 minutes.
4. Separate lettuce leaves, place tablespoons of mixture into each lettuce leaf. Serve immediately.

APRICOT CHICKEN

Serves: 4

Ingredients:

1 kg	chicken drumsticks
40 g	packet french onion soup
200 ml	apricot nectar
½ cup	dried apricot, halves

Method:

1. Combine all ingredients in a 2-litre casserole dish.
2. Cook on Medium-High for 20-25 minutes, turning once during cooking. Serve chicken with rice or pasta.

THAI GREEN CHICKEN CURRY

Serves: 4

Ingredients:

1	onion, chopped
2 tablespoons	red curry paste
500 g	chicken fillets, chopped
2 cups	finely sliced vegetables
1 cup	coconut milk

Method:

1. Place onion and curry paste in 3-litre casserole dish. Cook on HIGH for 3 to 4 minutes.
2. Add chicken and combine. Cook on MEDIUM-HIGH for 6 to 8 minutes, stirring once during cooking.
3. Add vegetables and coconut milk. Stir well. Cover and cook on HIGH for 4 minutes. Serve with Jasmine rice.

HONEY SESAME WINGS

Serves: 4-6

Ingredients:

1 kg	chicken wings
1 teaspoon	chopped garlic
1 teaspoon	chopped ginger
¼ cup	soy sauce
¼ cup	honey
2 tablespoons	sesame seeds

Method:

1. Place all ingredients in a 2-litre bowl, stir until combined. Marinate for at least 2 hours.
2. Remove chicken from marinade and place in a flat dish cook covered on Medium-High for 18-20 minutes.

GREEN PEPPERCORN CHICKEN

Serves: 4

Ingredients:

4	small single chicken breast fillets
1 tablespoon	butter
2 tablespoons	green peppercorns
1 tablespoon	seeded mustard
1 teaspoon	chicken stock powder
2 tablespoons	lemon juice
½ cup	cream

Method:

1. Flatten chicken fillets. Place butter and chicken in a 2-litre dish and cook on Medium-High 6-8 minutes. Turning halfway through cooking.
2. Remove chicken and add remaining ingredients to dish, stir well. Cook on High for 1-2 minutes. Serve sauce over chicken.

CHICKEN CACCIATORE

Serves: 4

Ingredients:

1 can (440 g)	tomatoes
¼ cup	tomato paste
1 teaspoon	minced garlic
1	onion, diced
2 teaspoons	dried oregano
1 kg	chicken drumsticks

Method:

1. Place all ingredients in 2-litre casserole dish. Stir until combined. Cover and cook on MEDIUM-HIGH for 12 to 15 minutes.
2. Turn chicken and stir. Cook on MEDIUM-HIGH for 12 to 15 minutes.

Main Fare Meats

Directions for Cooking Tender Cuts of Meat by Microwave

For best results, select roasts that are uniform in shape.

Place meat on a microwave rack in a suitable dish. Beef rib roast should be placed cut-side down. Other bone-in roasts should be placed fat-side down. Boneless roasts should be placed fat-side up. Halfway through cooking, turn roasts. Half hams should be shielded by wrapping an 8 cm wide strip of foil around the large end of the ham. Secure to the body of the ham with wooden toothpicks. Fold 3 cm over cut surface. For shank ham halves, shield shank bone by cupping it with foil. One third of the way through cooking, remove ham from oven and cut off skin. Turn fat side up and reshield edges. If desired, glaze last 10 to 20 minutes of cooking. Loosely cover baking dish with wax paper or paper towel to prevent splatter. If a large amount of juice accumulates in the bottom of the dish, drain occasionally. If desired, reserve for making gravy. Multiply the weight of the roast by the minimum recommended times per 500 g. Programme Power and Time.

Meats can be shielded at the beginning of cooking or halfway through cooking. If you wish to shield at the

beginning of cooking, remove foil halfway through the cooking time. Beef and pork rib roasts should be shielded by the bones. Foil should extend about 5 cm down from bones. The shank and thin ends of boneless roasts should also be shielded. Make sure foil does not touch the sides of the oven, as arcing may occur. Canned hams should be shielded on the top cut-edge with a 3 cm strip of foil. Wrap strip of foil around ham and secure to body of ham with wooden toothpicks. Fold 2 cm over cut surface. After heating, check temperature using a meat thermometer. The thermometer should not touch bone or fat. If it does, the reading could be inaccurate. Lower temperatures are found in the centre of the roast and in the muscle close to a large bone, such as a pork loin centre rib roast. If the temperatures are low, return meat to the oven and cook a few more minutes at the recommended power level. **DO NOT USE A CONVENTIONAL MEAT THERMOMETER IN THE MICROWAVE OVEN.** Let stand, covered with foil, 10 to 15 minutes. During standing time the internal temperature equalises and the temperature rises 5°C to 10°C.

Directions for Cooking Less-Tender Cuts of Meat by Microwave

Less-tender cuts of meat such as pot roasts should be cooked in liquid. Use ½ to 2 cups of soup, broth, etc. per 500 g of meat. Use an oven cooking bag or covered casserole when cooking less-tender cuts of meat. Select a covered casserole deep enough so that the meat does not touch the lid. If an oven cooking bag is used, prepare the bag according to package directions. Do not use wire or metal

twist-ties. Use the nylon tie provided, otherwise, use a piece of cotton string or a strip cut from the open end of the bag. Make six 2 cm slits in top of bag to allow steam to escape. Multiply the weight of the roast by the minimum recommended minutes per 500 g. Programme Power and Time. Turn meat over halfway through cooking. Meat should be tender when cooked.

Meat Chart for Microwave Cooking

MEAT	POWER	APPROX. COOKING TIME (minutes per 500 g)
Beef Roasts Medium Chuck, Flank, Brisket	Medium-High Medium	10 to 12 20 to 30
Pork Leg of Pork Loin of Pork Pork Chops	Medium-High Medium-High Medium-High	12 to 15 12 to 15 6 to 8
Lamb Medium Well	Medium-High Medium-High	10 to 12 12 to 15

Main Fare Meats

CHILLI BEEF

Serves: 4

Ingredients:

500 g	minced beef
1	onion, diced
1	clove garlic, crushed
1 (35 g)	packet chilli seasoning mix
1 can (410 g)	tomato puree
1 can (420 g)	kidney beans, drained

Method:

1. Place all ingredients in a 2-litre casserole dish. Mix well. Cook on High for 20-25 minutes. Stir halfway through cooking.
2. Serve in taco shells or in tortillas with salad and cheese.

CHINESE BEEF AND VEGETABLES

Serves: 4

Ingredients:

400 g	rump steak, sliced
1 teaspoon	chopped ginger
1	clove garlic, crushed
1 tablespoon	soy sauce
2 tablespoons	Hoi Sin sauce
¼ cup	beef stock
2 cups	sliced vegetables

Method:

1. Place steak, ginger and garlic in a 3-litre casserole dish. Cook on High for 1 minute.
2. In a 1 cup jug combine sauces with stock. Add to meat mixture. Cook on High for 1-2 minutes.
3. Add vegetables and cook on High for 4-5 minutes, stirring halfway through cooking.
4. Let stand for 5 minutes before serving with rice or noodles.

BEEF STROGANOFF

Serves: 4

Ingredients:

1	onion, sliced
500 g	rump steak sliced into ribbons
2 tablespoons	tomato sauce
2 tablespoons	worcestershire sauce
1	beef stock cube
½ cup	sour cream
200 g	sliced mushrooms

Method:

1. Place all ingredients (except sour cream and mushrooms) in 3-litre casserole dish. Stir until combined.
2. Cook on MEDIUM-HIGH for 8 to 10 minutes, stirring once during cooking. Add sour cream and mushrooms.
3. Stir and cook on MEDIUM-HIGH for 3 to 4 minutes.

SPAGHETTI MEAT SAUCE

Serves: 4

Ingredients:

500 g	minced beef
1	onion, diced
1	clove garlic, crushed
1 can (420 g)	tomatoes
½ cup	tomato paste
2 tablespoons	chopped basil

Method:

1. Combine all ingredients in a 3-litre casserole dish. Cook on High for 7-8 minutes, stir.
2. Cook on Medium-High for 14-16 minutes. Stirring halfway through cooking.
3. Serve over hot spaghetti.

FRENCH ONION BEEF CASSEROLE

Serves: 4

Ingredients:

1	onion, diced
1 teaspoon	mixed dried herbs
200 g	diced potatoes
500 g	chuck steak, cubed
20 g	french onion soup mix
½ cup	tomato puree
2 cups	beef stock

Method:

1. Place onion and herbs in a 3-litre casserole dish. Cook on High for 1-2 minutes.
2. Add remaining ingredients, stir until combined. Cover and cook on High for 10 minutes.
3. Stir and cook on Medium for 20-25 minutes, stirring once during cooking.
4. Let stand 5 minutes before serving.

BARBECUED MARINATED SPARE RIBS

Serves: 4

Ingredients:

1 kg	pork spare ribs
¾ cups	fruit chutney
¾ cup	tomato sauce
1 tablespoon	soy sauce
1 tablespoon	worcestershire sauce

Method:

1. Place all ingredients in 3-litre casserole dish and marinate for several hours or overnight.
2. Cook ribs on MEDIUM-HIGH for 24 to 26 minutes, turning once through cooking.

Vegetable Varieties

Directions for Cooking Vegetables

FRESH VEGETABLES BY MICROWAVE

Place vegetables in a casserole dish. Add 2 to 3 tablespoons of water per 500 g of vegetables. Add salt to water or add after cooking. Do not place salt directly on vegetables. Cover dish with glass lid or plastic wrap.

Cook on HIGH according to time recommended in charts. Halfway through cooking, stir, turn vegetables over or rearrange.

Vegetables that are to be cooked whole and unpeeled, need to be pierced to allow steam to escape. Place vegetables on a paper towel lined dinner plate. Allow to stand, covered, according to the time indicated in the charts.

FROZEN VEGETABLES BY MICROWAVE

Remove vegetables from package and place in an appropriate sized container. Vegetables frozen in a

pouch should be placed on a dish and the top pierced. Cook on HIGH according to directions given in chart. Vegetables should be cooked covered with a lid or plastic wrap.

Halfway through cooking, stir, turn vegetables over or rearrange. Stir after cooking. Allow to stand for 2 to 3 minutes before serving.

DRIED BEANS OR PEAS BY MICROWAVE

Place hot tap water in 4-litre dish. Bring hot water to the boil on HIGH for 10 to 12 minutes. Add beans and 2 tablespoons oil to water. Cook according to directions in chart. Stir. Allow to stand, covered, for 15 to 20 minutes.

Note: Beans such as red kidney beans and lima beans should be soaked overnight before cooking. 250 g of dried beans equals about 3 cups cooked beans. Use in place of canned beans.

Frozen Vegetables Chart for Microwave Cooking

VEGETABLE	QUANTITY	COOKING PROCEDURE	APPROX. COOKING TIME (in minutes) on HIGH
Beans	250 g	Cook in covered 2-litre dish.	4 to 6
Broad Beans	250 g	Cook in covered 2-litre dish.	5 to 7
Broccoli (spears)	350 g	Cook in covered 2-litre dish.	5 to 7
Brussels Sprouts	250 g	Cook in covered 2-litre dish.	5 to 7
Carrots (baby)	250 g	Cook in covered 2-litre dish.	6 to 8
Cauliflower	500 g	Cook in covered 2-litre dish.	5 to 7
Corn (½ cob)	½ ear (75 g)	Cook in covered 2-litre dish.	3 to 4
Corn (cobs)	250 g	Cook in covered 2-litre dish.	5 to 7
Mixed Vegetables	250 g	Cook in covered 2-litre dish.	5 to 7
Peas	250 g	Cook in covered 2-litre dish.	4 to 6
Spinach	250 g	Cook in covered 2-litre dish.	4 to 6

Dried Beans and Peas Chart for Microwave Cooking

ITEM	CONTAINER	AMOUNT OF HOT WATER	APPROX. TIME TO BOIL HOT WATER on HIGH (in minutes) COVERED	TO COOK BEANS on MEDIUM (in minutes) COVERED
Lentils (250 g)	4-litre dish	2 litres	10 to 12	15 to 20
Soup Mix (250 g)	4-litre dish	2 litres	10 to 12	15 to 20
Split Peas or Lentils (250 g)	4-litre dish	2 litres	10 to 12	20 to 25
Beans (250 g) Soaked overnight	4-litre dish	2 litres	10 to 12	25 to 30

Vegetable Varieties

Fresh Vegetables Chart for Time Cooking

Vegetables should be covered and cooked on HIGH power for best results. Weights given are trimmed weights.

VEGETABLE	QUANTITY	COOKING PROCEDURE	APPROX. COOKING TIME (in minutes) on HIGH
Asparagus	250 g	Covered dish with ¼ cup water.	3 to 5
Beans (finely sliced)	250 g	Covered dish with ¼ cup water.	4 to 5
Beets	4 whole (1 kg)	Covered with 1 cup water in 4-litre dish. Stand after cooking - 5 mins.	14 to 18
Broccoli	500 g	Flowerets only, in covered dish with ¼ cup water.	5 to 7
Brussels Sprouts	500 g	Covered dish with ¼ cup water.	4 to 6
Cabbage	500 g	Shredded, with ¼ cup water in covered dish.	6 to 8
Carrots	sliced finely 200 g	With ¼ cup water in covered dish.	3 to 5
Cauliflower	500 g	Flowerets with ¼ cup water in covered dish.	5 to 7
Celery	6 stalks (400 g) cut in 1 cm angled pieces	With ¼ cup water in covered dish.	4 to 6
Corn	2 ears (500 g) 4 ears (1 kg)	Brush with melted butter and cook in covered dish.	4 to 6 8 to 10
Eggplant	1 (500 g)	Dice with ¼ cup water in covered dish.	4 to 6
Mushrooms	250 g (sliced)	Cook with 2 tablespoons butter in covered dish.	3 to 4
Onions	3 (200 g)	Cut in quarters with ¼ cup water in covered dish.	5 to 7
Peas	250 g	Shell peas and place with ¼ cup water in covered dish.	3 to 5
Potatoes-Mashed -Jacket	5 (500 g)	Peeled and quartered with ¼ cup water. Prick skins. Place on paper towel, cook uncovered.	6 to 8 7 to 9
Pumpkin	500 g	Peeled and cut into uniform pieces with ¼ cup water in covered dish.	8 to 10
Spinach	250 g	Remove stem, cut leaves into small pieces. Cook with ¼ cup water in covered dish.	3 to 5
Sweet Potato	500 g	In serving size pieces with 2 tablespoons butter in covered dish.	6 to 8
Turnips	500 g	Peeled and sliced finely with ¼ cup water in covered dish.	6 to 8
Tomatoes	2 (300 g)	Sliced and cooked covered with 1 tablespoon butter in dish.	2 to 4
Zucchini	500 g	Cut in 2 cm pieces in covered dish.	5 to 7

Vegetable Varieties

CAULIFLOWER IN WHITE SAUCE

Serves: 4

Ingredients:

500 g	cauliflower florets
2 tablespoons	water
2 tablespoons	butter
2 tablespoons	flour
1 cup	milk
½ cup	grated tasty cheese

Method:

1. Place cauliflower and water in a shallow casserole dish. Cover and cook on High for 6-8 minutes.
2. Place butter in a 4 cup jug. Cook on High for 1-2 minutes, stir in flour and cook on High for 1 minute. Add milk gradually, stirring well and cook on High for 2-3 minutes. Stirring halfway through cooking.
3. Drain cauliflower, pour over sauce and sprinkle with cheese. Cook on Medium-High for 1-2 minute.

HONEY GLAZED CARROTS

Serves: 4

Ingredients:

500 g	carrots thinly sliced
2 tablespoons	brown sugar
2 teaspoons	butter
2 tablespoons	honey

Method:

Combine all ingredients in a 2-litre casserole dish. Cover and cook on High for 6-8 minutes, stirring halfway through cooking.

ORIENTAL VEGETABLES

Serves: 4 to 6

Ingredients:

1 tablespoon	oil
1 cup	celery, sliced diagonally
1	large onion, cut into petals
1	green capsicum, cut into 2.5 cm pieces
1	red capsicum, cut into 2.5 cm pieces
1 cup	sliced mushrooms
1 tablespoon	Hoisin sauce
2 teaspoons	soy sauce

Method:

1. Place oil and vegetables in a 2-litre casserole dish. Stir well. Cook on HIGH for 3 to 4 minutes, stirring halfway through cooking.
2. Mix sauces together in 1-cup glass jug and cook on HIGH for 1 minute. Pour over hot vegetables and mix well.

POTATO CASSEROLE

Serves: 4

Ingredients:

750 g	peeled and sliced potatoes
1 cup	sour cream
¼ cup	milk
3	spring onions sliced
2	bacon rashers, chopped
½ cup	grated cheese

Method:

1. Layer potatoes in a 2-litre casserole dish. Pour over combined sour cream and milk. Cook on High for 15-18 minutes.
2. Top with spring onions, bacon and cheese. Cook on High for 5 minutes.

VEGETABLES CURRY

Serves: 4

Ingredients:

1	onion sliced
2 tablespoons	green curry paste
3 cups	sliced vegetables
1 can (440 g)	chick peas, drained
1 cup	coconut milk
1 tablespoon	lemon juice
1 tablespoon	soy sauce
½ cup	chopped nuts

Method:

1. Place onion and curry paste in a 3-litre casserole dish. Cook on High for 2 minutes.
2. Add remaining ingredients except nuts and stir. Cook on High for 4-5 minutes. Sprinkle with chopped nuts and serve.

STUFFED TOMATOES

Serves: 2

Ingredients:

2	tomatoes (large)
¼ cup	fresh breadcrumbs
½ cup	grated cheese
4	shallots, finely sliced
1 tablespoon	finely chopped parsley
	salt and pepper
¼ cup	extra grated cheese

Method:

1. Cut tops off tomatoes. Scoop out pulp of tomato with a teaspoon. Mix pulp with remaining ingredients, except extra cheese.
2. Spoon mixture back into tomato shells. Sprinkle tomatoes with extra cheese.
3. Place tomatoes in 2-litre casserole dish and cook on HIGH for 2 to 3 minutes. Serve.

Tip: To cook 4 stuffed tomatoes, cook on HIGH for 6 to 8 minutes.

Rice, Pasta and Cereal

Directions for Cooking Rice and Other Grains by Microwave

Follow directions in chart for recommended dish size, amounts of water and cooking time. Add grain to boiling water. Add salt and butter according to package directions. Cook on HIGH for time

recommended in chart. Allow to stand, covered, before serving. For special rice, substitute beef or chicken stock for water. Add cooked onion, mushrooms or crumbled bacon before serving.

ITEM	CONTAINER	AMOUNT OF BOILING WATER	APPROX. TIME TO COOK GRAIN on HIGH UNCOVERED (in minutes)	STANDING TIME (in minutes)
RICE				
Quick Cook Brown (1 cup)	4-litre dish	2½ cups	16 to 19	5
Brown (1 cup)	4-litre dish	3 cups	25 to 30	10
Long Grain (1 cup)	3-litre dish	2 cups	13 to 15	5
Short Grain (1 cup)	3-litre dish	2 cups	12 to 14	5
Jasmine (1 cup)	3-litre dish	2 cups	12 to 14	5

Directions for Cooking Pasta by Microwave

Follow directions in chart for recommended dish size, amount of water and cooking time. Boil water, with 1 teaspoon salt and 1 tablespoon oil. Add pasta and cook for time recommended in chart. Cook on

HIGH. Test pasta for desired cooking before adding more time. Slightly undercook pasta that will be heated again in casserole. Stir and let stand, uncovered, 5 minutes.

ITEM	CONTAINER	AMOUNT OF BOILING WATER	APPROX. TIME TO COOK PASTA on HIGH UNCOVERED (in minutes)	STANDING TIME (in minutes)
Dried Fettuccine (250 g)	4-litre dish	6 cups	14 to 16	5
Elbow Macaroni, shells, etc. (250 g)	3-litre dish	4 cups	14 to 16	5
Fresh Spaghetti, Fettuccine (375 g)	4-litre dish	6 cups	6 to 8	5
Dried Spaghetti (250 g)	4-litre dish	4 cups	14 to 16	5
Fresh Tortellini, Ravioli (250 g)	4-litre dish	4 cups	8 to 10	5

Drain pasta after standing.

Directions for Cooking Hot Cereal by Microwave

Combine ¼ cup of quick cooking oats, pinch salt and ¾ cups hot tap water in a breakfast bowl.



Cook on HIGH for 2 to 3 minutes, stirring halfway through cooking.

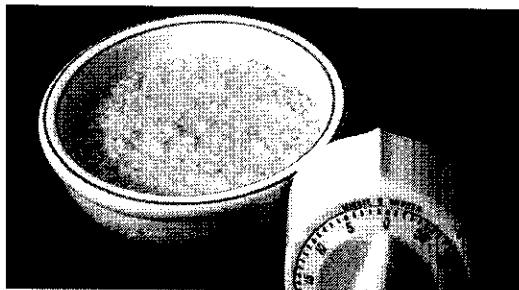

Let stand, 1 to 2 minutes, before serving. Top as desired with sugar or spices.

Rice, Pasta and Cereal

BACON AND ONION TORTELLINI

Serves: 4

Ingredients:

600 g fresh tortellini
 6 cups boiling water
 1 onion, diced
 1 clove garlic, crushed
 3 rashers bacon, chopped
 300 ml cream
 1 tablespoon parmesan cheese
 1 teaspoon chicken stock powder
 2 tablespoons chopped parsley
 ground black pepper
 Parmesan cheese, extra

Method:

- Place pasta and water in a 3-litre casserole dish. Cook on High for 8-10 minutes. Stand covered for 2 minutes. Drain.
- Place onion, garlic and bacon in a 2-litre casserole dish and cook on High for 5 minutes. Add cream, cheese, stock powder and parsley stir until combined.
- Add pasta and cook on High for 2 minutes. Serve sprinkled with pepper and extra parmesan cheese.

PESTO FETTUCCINE

Serves: 4

Ingredients:

250 g dried fettuccine
 6 cups boiling water
 2 cloves garlic, crushed
 1 cup basil leaves
 1 tablespoon pinenuts
 ½ cup parmesan cheese
 1 cup olive oil

Method:

- Place pasta and water in a 3-litre casserole dish. Cook on High for 14-16 minutes. Allow to stand for 5 minutes then drain.
- Place remaining ingredients except oil in a food processor. Slowly add oil in a fine stream while processing.
- Stir sauce through pasta and serve.

CHICKEN RISOTTO

Serves: 4

Ingredients:

300 g fresh asparagus
 2 tablespoons olive oil
 1½ cups aborio rice
 1 clove garlic, crushed
 4 cups boiling chicken stock
 2 cups coarsely chopped cooked chicken
 ¼ cup grated fresh parmesan cheese
 ¼ cup cream
 ground black pepper
 extra coarsely grated parmesan cheese

Method:

- Place asparagus in a 2-litre dish and cook on High for 1 minute. Set aside.
- Place oil, rice and garlic in a 3-litre casserole dish, cover and cook on High for 1 minute. Add 2 cups of boiling chicken stock, cook on High for 5 minutes. Stir twice during cooking.
- Add remaining chicken stock and cook on High for another 5 minutes. Add remaining ingredients including asparagus and stir into risotto. Cook covered on High for 2 minutes.
- Stand for 5 minutes. Serve topped with pepper and extra parmesan cheese.

STIR FRIED RICE

Serves: 4

Ingredients:

1 tablespoon vegetable oil
 1 clove garlic, crushed
 1 teaspoon ginger
 1 small carrot, finely chopped
 1 stick celery, sliced
 ½ red capsicum, diced
 6 to 8 medium mushrooms, sliced
 4 shallots, chopped
 2 eggs
 black pepper
 1 small can prawns (optional)
 1-2 tablespoons soy sauce
 2 cups cooked rice

Method:

- Place oil, garlic and ginger in large shallow dish and cook on HIGH for 1 to 2 minutes. Add carrot, celery and capsicum. Cook a further 3 minutes on HIGH.
- Break eggs into small dish, add pepper to taste, mix well and cook on MEDIUM-HIGH for 1½ to 2 minutes. Slice into thin strips.
- Add eggs plus all remaining ingredients to vegetable mixture. Stir well and cook on HIGH for 3 to 5 minutes to heat thoroughly. Serve.

Desserts

BUTTERSCOTCH PUDDING

Serves: 4 to 6

Ingredients:

1 can (400 g)	sweetened condensed milk
30 g	butter
1 teaspoon	vanilla essence
½ cup	milk
¼ cup	self raising flour, sifted
1 cup	brown sugar
½ cup	hot tap water

Method:

- Place condensed milk in 2-litre casserole dish. Cook on MEDIUM for 6 to 7 minutes, stirring twice during cooking.
- Stir in butter, vanilla essence and milk. Stir until butter is melted. Cool slightly.
- Add milk mixture to sifted flour. Mix well. Pour mixture into 2-litre casserole dish.
- Sprinkle top with brown sugar and gently pour hot tap water over mixture. Cook on HIGH for 6 to 8 minutes.

APRICOT AND RASPBERRY CRISP

Serves: 4 to 6

Ingredients:

1 can (850 g)	apricots, drained
400 g	frozen raspberries
1 cup	plain flour
½ cup	brown sugar
1 teaspoon	cinnamon
1 cup	pecans, chopped
1 cup	shredded coconut
2 cups	toasted muesli
125 g	butter

Method:

- Place apricots and raspberries in the base of 2-litre casserole dish. Place remaining ingredients (except butter) in a mixing bowl.
- Melt butter in 2-cup jug on HIGH for 40 to 50 seconds. Combine melted butter with dry ingredients and mix well.
- Crumble mixture over top of fruit. Cook on HIGH for 10 to 12 minutes.

PEAR CUSTARD

Serves: 6

Ingredients:

825 g	pear halves, drained
2 tablespoons	plain flour
½ cup	caster sugar
3	eggs
1 teaspoon	vanilla essence
1 cup	milk
1 teaspoon	cinnamon

Method:

- Grease 20 cm square pyrex dish. Place pear halves in dish. Set aside. Place flour, sugar, eggs and vanilla essence in bowl. Whisk until combined.
- Whisk in milk and pour mixture over pears. Sprinkle with cinnamon. Cover dish with plastic wrap and cook on HIGH power for 8 to 10 minutes.

CHOCOLATE MOUSSE

Serves: 4

Ingredients:

125 g	dark chocolate
1 tablespoon	brandy
2	eggs, separated
300 ml	cream, whipped

Method:

- Break chocolate into small pieces. Place in a microwave safe bowl and cook on MEDIUM-HIGH for 1 to 1½ minutes.
- Add brandy and egg yolks. Beat until smooth. Fold cream into chocolate mixture.
- Beat egg whites until stiff peaks form. Gently fold into chocolate mixture and spoon into one large or 4 individual serving dishes. Refrigerate until set.

CHOCOLATE BROWNIES

Serves: 1 x 20 cm
square slice pan

Ingredients:

125 g	butter
200 g	chocolate
1 cup	caster sugar
1 teaspoon	vanilla essence
2	eggs
1 cup	plain flour

Method:

- Grease and line 20 cm square pyrex dish. Set aside. Melt butter and chocolate in 2-litre dish on HIGH for 2 minutes.
- Stir in sugar, vanilla essence, eggs and flour. Spread into prepared dish.
- Cook on MEDIUM-HIGH for 7 to 8 minutes. Refrigerate until cold. Cut into squares.

Before Requesting Service

THESE THINGS ARE NORMAL

The oven causes interference with my TV.	Some radio and TV interference might occur when you cook with the microwave oven. This interference is similar to the interference caused by small appliances such as mixers, vacuums, hair dryers, etc. It does not indicate a problem with your oven.
The oven lights dim.	When cooking with a power other than P10 (HIGH) power, the oven must cycle to obtain the lower power levels. The oven light will dim and clicking noises can be heard when the oven cycles.
Steam accumulates on the oven door and warm air comes from the oven vents.	During cooking, steam and warm air are given off from the food. Most of the steam and warm air are removed from the oven by the air which circulates in the oven cavity. However, some steam will condense on cooler surfaces such as the oven door. This is normal.
I accidentally ran my microwave oven without any food in it.	Running the oven empty for a short time will not damage the oven. However, we do not recommend this.

PROBLEM	POSSIBLE CAUSE	REMEDY
Oven will not turn on.	The oven is not plugged in securely.	Remove plug from outlet, wait 10 seconds and re-insert.
	Circuit breaker or fuse is tripped or blown.	Reset external circuit breaker or replace external fuse.
	There is a problem with the outlet.	Plug another appliance into the outlet to check if the outlet is working.
Oven will not start cooking.	The door is not closed completely.	Close the oven door securely.
	Start was not pressed after programming.	Press Start Pad.
	Another programme has already been entered into the oven.	Press Stop/Reset Pad to cancel the previous programme and programme again.
	The programme has not been entered correctly.	Programme again according to the Operating Instructions.
When the oven is turning on, there is noise coming from the Glass Tray.	Stop/Reset has been pressed accidentally.	Programme over again.
	The Roller Ring and oven bottom are dirty.	Clean these parts according to "Care of Your Microwave Oven" (see next page).

If it seems there is a problem with the oven, contact an authorised Service Centre.

Care of your Microwave Oven

BEFORE CLEANING:

Unplug at socket of the oven. If impossible, leave oven door open to prevent oven from accidentally turning on.

AFTER CLEANING:

Be sure to replace the Roller Ring and Glass Tray in the proper position and press **Stop/Reset** Pad to clear the Display Window.

Inside of the oven:

Wipe with a damp cloth. Mild detergent may be used if the oven gets very dirty. The use of harsh detergent or abrasives is not recommended.

Glass Tray:

Remove and wash in warm soapy water or in a dishwasher. If grease accumulates, clean with a non-abrasive nylon mesh scouring pad and a non-abrasive cleanser.

Outside oven surfaces and back vents.

Clean with a damp cloth. To prevent damage to the operating parts inside the oven, water should not be allowed to seep into ventilation openings.

Control Panel:

- Covered with removable protective film to prevent scratches during shipping. Small bubbles may appear under this film. When this happens, remove film carefully. (Hint - apply masking or clear tape to an exposed corner and pull gently to remove.)
- If it becomes wet, clean with a soft, dry cloth. Do not use harsh detergents or abrasives on the Control Panel.

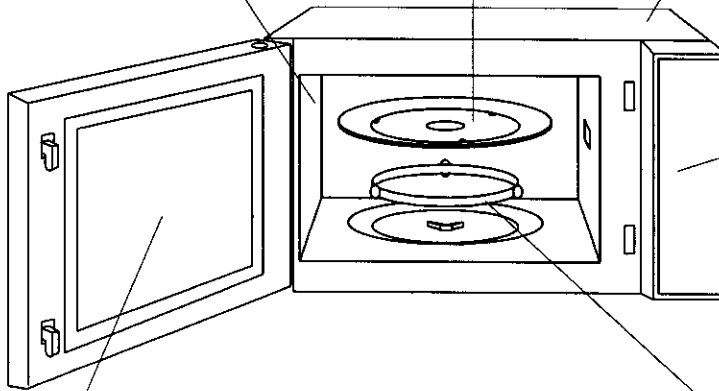

Oven Door:

Wipe with a soft cloth when steam accumulates inside or around the outside of the oven door. This may occur when the microwave oven is operated under high humidity conditions and in no way indicates a malfunction of the unit or of microwave leakage.

Roller Ring and oven cavity floor:

Wipe the bottom surface of the oven with mild detergent water or window cleaner and dry. Roller Ring may be washed in mild soapy water or dishwasher. These areas should be kept clean to avoid excessive noise.

Technical Specifications





Power Supply*:	230 - 240 V 50 Hz
Power Consumption:	5.4A 1,200 W
Output:**	800 W
Outside Dimensions (H x W x D):	282 x 482 x 357 mm
Oven Cavity Dimensions (H x W x D):	218 x 325 x 330 mm
Operating Frequency:	2,450 MHz
Uncrated Weight:	Approx. 12 kg

*Voltage requirement may differ by country. Check your identification plate for power supply voltage required.

**IEC 705-88 Test Procedure

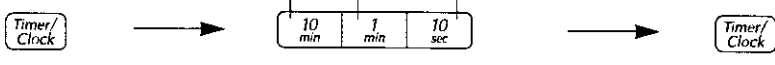
Specifications subject to change without notice.

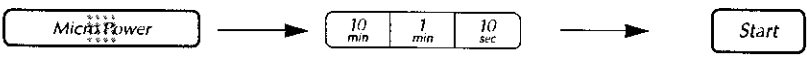
Quick Guide to Operation (for NN-MX25)

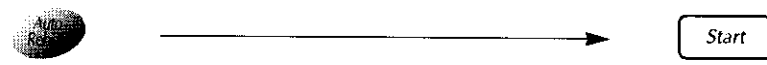
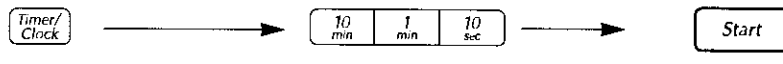
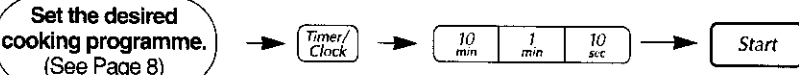
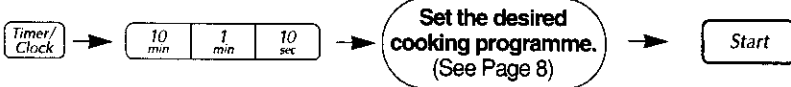
Feature	How to Operate
To Set Clock (See page 9)	<p>(Hours) (10 Minutes) (1 minute)</p>  <p>Twice. Set time of day. (Max 12:59)</p>
To Set / Cancel Child Safety Lock (See page 9)	<p>To Set: Display</p>  <p>3 times</p> <p>To Cancel: Display</p>  <p>3 times Colon or time of day</p>
To Cook / Reheat / Defrost by Micro Power and Time Setting (See page 8)	 <p>Select power. Set the cooking time.</p>
To Use Turbo Defrost Pad (See page 12)	 <p>Set weight.</p>
To Reheat using "Auto Reheat" Pad (See page 14)	 <p>Select desired weight.</p>
To Use as a Kitchen Timer (See page 15)	 <p>Once. Set time.</p>
To Set Standing Time (See page 15)	 <p>Once. Set time.</p>
To Set Delay Start (See page 15)	 <p>Once. Set time.</p>