

Operating instructions

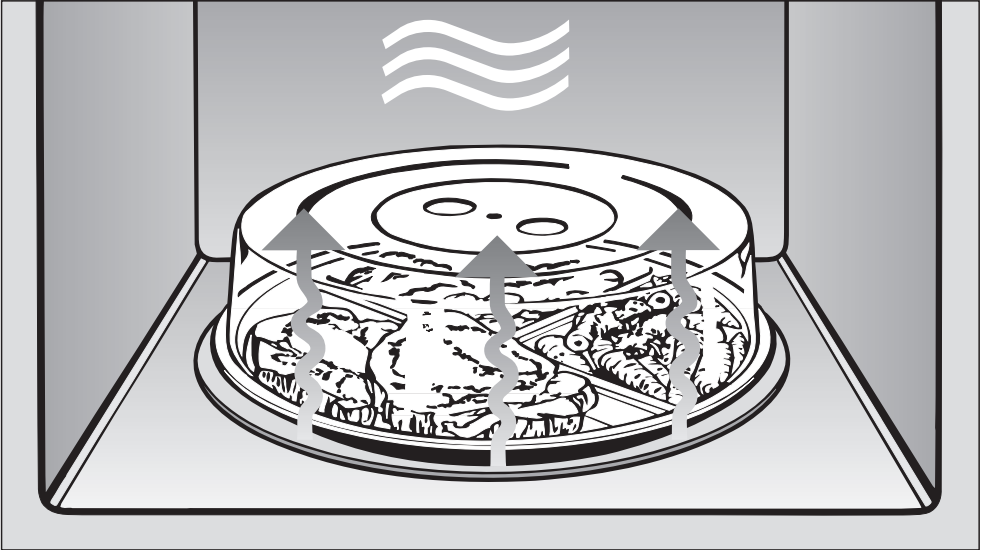

Microwave oven M 613 G

To avoid the risk of accidents
or damage to this appliance
it is **essential** to read these instructions
before it is installed or used for the first time.



Contents

Description of the appliance	4
Oven interior and accessories	4
Control panel	5
Accessories supplied	6
Grilling rack	6
Glass tray	6
Cover	6
Boiling rod	6
Optional accessories	6
Gourmet plate	6
Caring for the environment	7
Warning and Safety instructions	8
How the microwave oven functions	14
How does the microwave oven function?	14
Programmes	15
What can a microwave oven do?	15
In what ways can a microwave oven be used?	15
Microwave-solo mode	15
Grilling	15
Combination mode (Microwave + Grill)	15
Suitable containers for microwave ovens	16
Material and shape	16
Testing dishes for their suitability	18
The cover	19
Before using for the first time	20
Time of day display	21
Setting the time of day	21
Altering the time of day	21
Switching off the time of day display	21
Night time	21

Operation	22
To open the door	22
Placing the dish in the oven.	22
Turntable	22
To close the door	22
Starting a programme	23
Interrupting or re-starting a programme	24
Altering the settings	24
To cancel a programme	24
At the end of a programme	24
Automatic warming function	24
Quick start (programmable)	25
Safety lock	25
Minute minder	26
Altering a minute minder entry	26
Grilling	27
Reheating	29
Cooking	30
Defrosting / Defrosting and reheating or cooking	31
Other uses	32
Cleaning and care	33
Oven housing, cavity and door interior	33
Appliance front and control panel	35
Accessories supplied	36
Problem solving guide	37
After Sales Service	39
Electrical connection	40
Electrical connection U.K.	40
Installation	42
Technical data	43

Description of the appliance

Oven interior and accessories

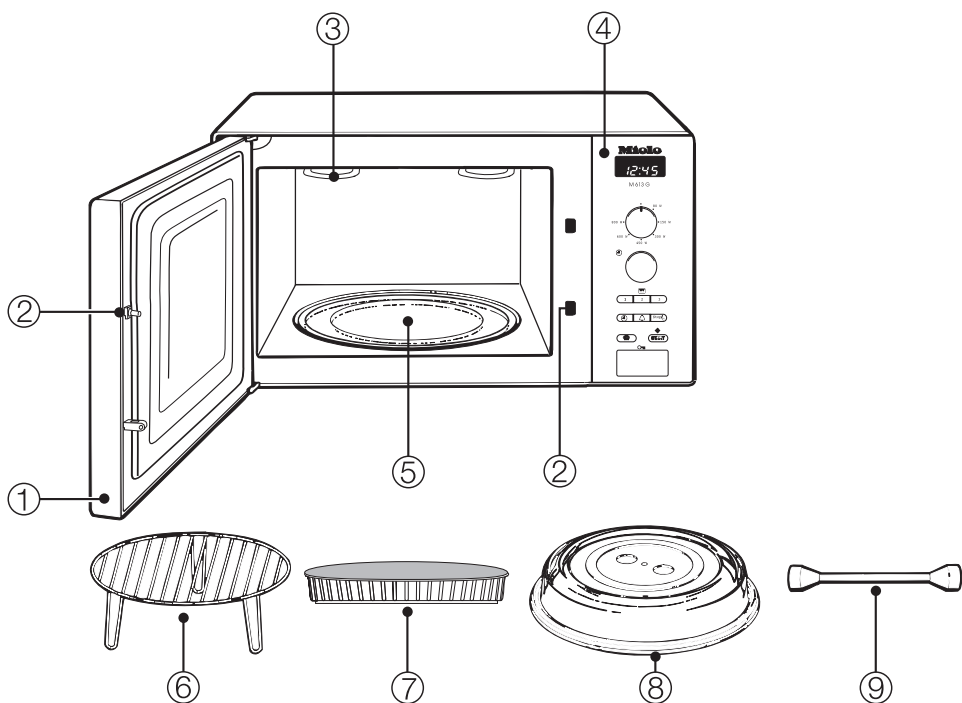

① Oven door

② Door locking mechanism

③ Grill / browning element

④ Control panel

⑤ Turntable

⑥ Grilling rack

⑦ Glass tray

⑧ Cover

⑨ Boiling rod

Control panel

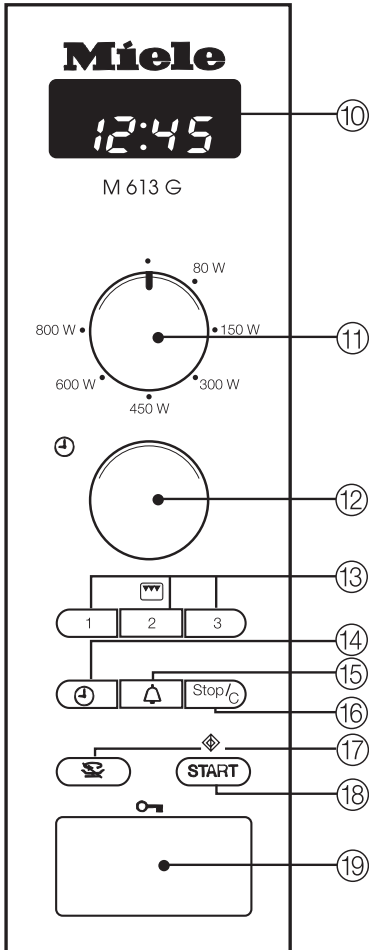

- ⑩ Electronic clock display
- ⑪ Microwave power selector
- ⑫ Time selector
- ⑬ Grill selector buttons (3 power settings)
- ⑭ Time of day button ⌚
- ⑮ Minute minder button 🔔
- ⑯ Stop / cancel button
- ⑰ Turntable button 🔄
- ⑱ START / Quick-Start (programmable) ⬠
- ⑲ Door release button 🔑

Description of the appliance

Accessories supplied

Grilling rack

The grilling rack is specially designed for use in a microwave oven. It can be used when grilling (with or without the microwave function).

Glass tray

The glass tray is suitable for use with all cooking functions.

When grilling directly on the rack, the glass tray should be placed underneath the rack to catch any fat or juices.

Cover

The cover supplied may only be used in the microwave-solo mode.

It prevents the food from drying out and the oven from becoming dirty, and it accelerates the heating process.

Boiling rod

When heating liquids, the boiling rod provided should be placed into the container. It helps liquids to heat evenly.

Optional accessories

Gourmet plate

The Gourmet plate is a round, non-stick grilling plate. It can be used to heat snacks or small meals quickly whilst maintaining crispness, and it is available from the Miele Spare Parts Department or your dealer.

Disposal of the packing material

The transport and protective packing has been selected from materials which are environmentally friendly for disposal and can normally be recycled.

Ensure that any plastic wrappings, bags etc. are disposed of safely and kept out of the reach of babies and young children. Danger of suffocation!

Rather than just throwing these materials away, please ensure that they are recycled.

Disposal of your old appliance

Old appliances contain materials which can be reclaimed or recycled. Please contact your dealer, your local waste collection centre or scrap merchant about potential recycling schemes.

Ensure that the appliance presents no danger to children while being stored for disposal.

Warning and Safety instructions

This appliance complies with all relevant legal safety requirements. Read these operating instructions carefully before installation and before using the appliance for the first time. They contain important notes on installation, safety, operation and care of the appliance. This way you will avoid the risk of accidents and damage to the appliance. Keep these instructions in a safe place and pass them on to any future user.

Correct use

The appliance is intended for domestic use only: to cook, defrost, reheat and to grill food. Any other usage is not supported by the manufacturer and could be dangerous. The manufacturer cannot be held liable for damage caused by improper or incorrect use of the appliance.

Never use the microwave to store or dry items which could ignite easily. Moisture evaporates. Fire hazard.

This appliance is not a toy! To avoid the risk of injury, do not let children access the appliance or its controls. Supervise its use by older children, the elderly or infirm. If allowing older children to use the appliance without supervision, please ensure that they are aware of how a microwave oven works and that they understand the dangers of improper use.

Technical safety

Do not use the microwave if

- the door is warped.
- the door hinges are loose.
- holes or cracks are visible in the casing, the door, the door seal or the oven interior walls.

Operating the appliance with this type of damage will result in microwave leakage and present a hazard to the user.

Repairs may only be carried out by a suitably qualified and competent person in accordance with national and local safety regulations. Repairs and other work by unqualified persons could be dangerous. The manufacturer cannot be held liable for unauthorised work.

Ensure that current is not supplied to the appliance while maintenance or repair work is being carried out.

In countries where there are areas which may be subject to infestation by cockroaches or other vermin, pay particular attention to keeping the appliance and its surroundings in a clean condition at all times. Any damage caused by cockroaches or other vermin will not be covered by the appliance guarantee.

Never open the casing of the appliance.

Tampering with electrical connections or components and mechanical parts is highly dangerous and can cause operational faults or electric shock.

If the connection cable is damaged, the new cable must be fitted by a Miele approved service technician.

Warning and Safety instructions

Before connecting the appliance to the mains supply, make sure that the rating on the data plate corresponds to the voltage and frequency of the household supply. This data must correspond in order to avoid risk of damage to the appliance. Consult a qualified electrician if in doubt.

The electrical safety of this appliance can only be guaranteed when continuity is complete between the appliance and an effective earthing system, which complies with local and national safety regulations. It is most important that this basic safety requirement is present and regularly tested. Where there is any doubt, the electrical wiring in the home should be checked by a qualified electrician. The manufacturer cannot be held liable for the consequences of an inadequate earthing system (e.g. electric shock).

The appliance is only completely isolated from the electricity supply when:

- it is switched off at the wall socket and the plug removed. (Pull on the plug, not the cable).
- the mains fuse is withdrawn.
- or the screw-out fuse is removed (in countries where this is applicable).

Do not connect the appliance to the mains electricity supply by an extension lead. Extension leads do not guarantee the required safety of the appliance (e.g. danger of overheating).

This equipment is not designed for maritime use or for use in mobile installations such as caravans, aircraft etc. However it may be suitable for such usage subject to a risk assessment of the installation being carried out by a suitably qualified engineer.

Use

Always ensure that food is sufficiently heated.

Many factors will affect the overall cooking time, including the size and amount of food, its initial temperature, changes to the recipe and the shape and size of cooking container. Some foods may contain micro-organisms which are only destroyed by thorough cooking. Therefore when cooking or reheating food such as poultry, it is particularly important that it is fully cooked through (at temperatures over 70 °C for more than 10 minutes). If in doubt, select a longer cooking or reheating time.

It is important that the heat is allowed to spread evenly throughout the food being cooked. This can be achieved by stirring and/or turning the food and by observing a sufficiently long standing time, which should be added to the time needed for cooking, reheating or defrosting.

Warning and Safety instructions

Always remember that times for cooking, reheating and defrosting are usually considerably shorter than with traditional methods of food preparation.

Excessively long cooking times can lead to food drying out and burning or could even cause it to catch fire. There is also a danger of fire if breadcrumbs, flowers, herbs etc. are dried in the microwave oven. Always ensure that this type of procedure is supervised.

Do not use the microwave function to heat up cushions or pads filled with cherry kernels, wheat grains, lavender or gel, such as those used in aromatherapy. These pads can ignite when heated even after they have been removed from the microwave.

Fire hazard.

Exercise caution when cooking or reheating food with a high sugar content, e.g. Christmas pudding. If heated for too long the sugar may caramelize or ignite.

Do not use full power to warm empty dishes. Do not use the appliance without food, or if it is incorrectly loaded.

Never cook or reheat food or liquids in sealed containers or bottles.

With baby bottles, the screw top **and** teat must be removed. Otherwise pressure builds up which can cause the bottle or container to explode, posing a severe risk of injury.

Before serving, remember to allow a sufficient standing time and then always check the temperature of the actual food itself after taking it out of the microwave. The temperature of the container is not an indication of the temperature of the food in it. **This is particularly important when preparing food for babies, children, and the elderly or infirm.** Shake or stir baby milk and food thoroughly after heating, and try it for temperature to ensure that it will not scald the baby. When heating food and drink remember that the heat is created in the food itself, and that the container will normally be cooler. The dish is only warmed by the heat of the food.

When heating liquids, the boiling rod provided should be placed in the container.



When heating liquids, milk, sauces etc in the oven without the boiling rod, the boiling point of the liquid may be reached without the production of typical bubbles. The liquid does not boil evenly throughout.

Warning and Safety instructions

This so-called 'boiling delay' can cause a sudden build up of bubbles when the container is removed from the oven or shaken. This can lead to the liquid boiling over suddenly and explosively. Danger of burning.

The formation of bubbles can be so strong that the pressure forces the oven door open. The user could be injured and the appliance damaged.

The boiling rod ensures that the liquid boils evenly and that bubbles form at an early stage during the operation.

■ To avoid fuelling any flames, do not open the oven door if smoke occurs in the oven interior.

Interrupt the process (by pressing the Stop/C button twice). Switch off at the wall socket, and where applicable remove the plug. Do not open the door until the smoke has dispersed.

■ Never heat undiluted alcohol in the microwave oven as this can easily ignite. Fire hazard.

■ Do not heat up tins in the microwave oven. Pressure can build up and they may explode. This could result in injury or damage.

■ Do not use any containers or cutlery made from or containing metal, aluminium foil, lead crystal glassware, temperature-sensitive plastics, wooden utensils or cutlery, metal clips or wire ties. Do not use bowls with milled rims, or cream pots with the tinfoil lid only partially removed. Such items could be damaged or cause a fire hazard. The rack supplied with the appliance is designed to be compatible with microwaves and can

therefore be used for grilling with or without the microwave function.

■ Do not leave the oven unattended when reheating or cooking food in disposable containers made of plastic, paper or other inflammable materials. Before using single use containers make sure they are suitable for use in microwave ovens. See appropriate section.

■ Eggs can only be cooked in their shells in the microwave oven in a specially designed egg-boiling device available from specialist shops. Similarly, hard-boiled eggs should not be reheated in the microwave oven as this may lead to the eggs bursting, even after they have been taken out of the oven.

■ Eggs can be cooked without their shells in the microwave oven only if the yolk membrane has been punctured several times first. The pressure could otherwise cause the egg yolk to explode. Danger of injury.

■ Food with a thick skin or peel, such as tomatoes, sausages, jacket potatoes and aubergines, should be pierced or the skin cut in several places before cooking to allow steam to escape and prevent the food from bursting.

Warning and Safety instructions

Do not reheat food in the oven in heat-retaining bags intended for normal ovens. These heat-retaining bags usually contain a thin layer of aluminium foil which reflects microwaves. This reflected energy can, in turn, cause the outer paper covering to become so hot that it ignites.

Always ensure that food or a browning dish has been placed in the microwave, and that the turntable is in place, before switching on.

Do not use the oven for frying food and do not leave it unattended when cooking with oils and fats as these can be a fire hazard if allowed to overheat.

Ovenproof earthenware can retain a considerable amount of moisture. Earthenware and porcelain containers with hollow handles and lid knobs must only be used in this oven if they have vent holes which allow the moisture to escape. Without vent holes there can be a pressure build-up, causing the container to crack or shatter, with the danger of injury.

When grilling with or without the microwave function, the rack, oven interior, grill element, door and housing can get hot. Do not let small children touch the oven while it is in operation, as there is the danger of being burnt. Supervise its use by the elderly or infirm.

Wear oven gloves when taking dishes in and out of the oven, or when handling dishes or food in the oven if the grill is on or has just been in operation. Danger of burning.

The rack and glass tray get hot during grilling (with and without microwave). Take care not to burn yourself on them.

Never place the hot glass tray (or any other hot cooking containers) on a cold surface, such as a tiled or granite worktop. The glass tray or container could crack or shatter, and the worktop surface could get damaged. Use a heat-resistant mat or wire cooling rack.

Do not use the oven to heat up the room. Due to the high temperatures radiated, objects left near the oven could catch fire.

Do not use the appliance as a resting place for other items. The heat from the top of the appliance could cause some kinds of items to melt.

To check food temperature, first interrupt the cooking programme. Only use a thermometer specifically approved for use in a microwave oven to measure the temperature of the food. Never use a thermometer containing mercury or liquid, as these are not suitable for use with very high temperatures and will break very easily.

Never use a steam-cleaning appliance to clean the microwave oven. Pressurised steam could reach the electrical components and cause a short circuit.

Warning and Safety instructions

When using browning dishes:

- Always use oven gloves when handling the browning dish to avoid burns.
- Never place the browning dish directly onto a table or work surface. Use a suitable heat-resistant mat, grid or board to protect the work surface or table and prevent heat marks.
- Browning dishes should only be used in a microwave oven or as a serving dish.
In a conventional oven the special glaze would suffer damage.

Disposal of your old appliance

- Before disposing of your old appliance first make it unusable. Cut off and render any plug unusable. Cut off the cable directly behind the appliance to prevent misuse. This should be done by a competent person.

The manufacturer cannot be held liable for damage caused by non-compliance with these Warning and Safety instructions.

How the microwave oven functions

How does the microwave oven function?

In a microwave oven there is a high-frequency tube called a magnetron. This converts electrical energy into microwaves. These microwaves are distributed evenly throughout the oven interior and rebound off the metal sides of the oven interior to reach the food from all sides. Microwave distribution is improved with the turntable engaged.

In order for microwaves to reach the food, they must be able to penetrate the cooking utensil being used. Microwaves can penetrate porcelain, glass, cardboard and plastics, but not metal. Do not, therefore, use utensils made of metal, or which contain metal, for example in the form of gold or silver trim. The metal reflects the microwaves and this could lead to the creation of sparks. The microwaves cannot be absorbed.

Microwaves pass through a suitable container and find their way directly into the food. All food contains moisture molecules which, when subjected to microwave energy, start to oscillate 2.5 thousand million times a second. The friction caused by this vibration creates heat, which first starts developing around the outside of the food and then slowly penetrates towards the centre. The moisture, fat and sugar content of food will affect the speed at which it is cooked.

As heat is produced directly in the food,

- food can generally be cooked without adding much liquid or cooking oil.
- cooking, reheating and defrosting in a microwave oven is quicker than using conventional methods.
- nutrients, such as vitamins and minerals, are generally retained.
- the colour, texture and taste of food are not impaired.

Microwaves stop being produced as soon as the cooking process is interrupted or the appliance door is opened.

When the appliance is in operation, the closed, sealed door prevents microwaves escaping from the appliance.

What can a microwave oven do?

In the microwave oven, food is cooked, reheated or defrosted quickly.

You can use your microwave in the following ways:

- Food can be defrosted, reheated or cooked by entering a power setting and a time.
- Deep frozen ready-made meals can be defrosted and then reheated or cooked.
- The microwave oven can also be used for other tasks, e.g. for proving dough, melting chocolate and butter, dissolving gelatine etc.

In what ways can a microwave oven be used?

Microwave-solo mode

Suitable for defrosting, reheating and cooking.

Grilling

Ideal for grilling thin cuts of meat, e.g. steak or sausages.

Combination mode (Microwave + Grill)

Ideal for dishes with toppings. The microwave cooks the food and the grill browns it.

Suitable containers for microwave ovens

Microwaves

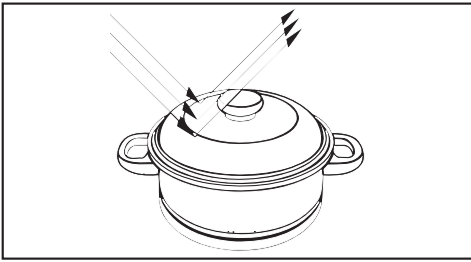

- are reflected by metal,

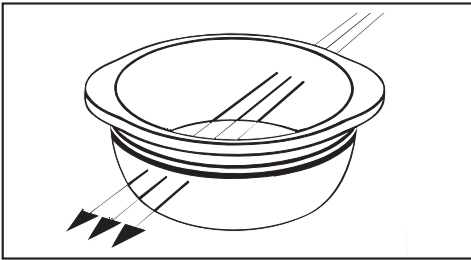

- pass through glass, porcelain, plastic and card,

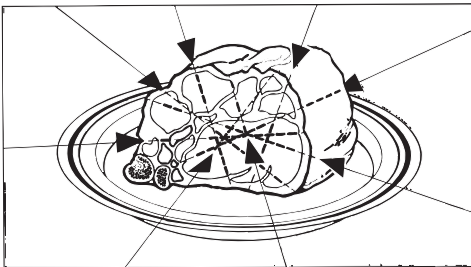

- and are absorbed by food.

Material and shape

The material and shape of containers used affect cooking results and times. Heat distribution is more even in round and oval shaped flat containers than in rectangular containers, providing better results.

Metal

Metal containers, aluminium foil and metal cutlery, or china with metallic decoration, such as gold rims or cobalt blue must not be used in an oven being used in microwave mode.

The metal reflects the microwaves, hindering the cooking process.

Exceptions:

- Ready-meals in aluminium foil dishes

These can be defrosted and reheated in the microwave oven, if recommended by the manufacturer. Important: Remove the lid first.

However, as food is only heated from the top it is better to remove the food from the aluminium foil container and transfer it to a dish suitable for a microwave oven. The heat distribution will be more even.

If sparks and arcing occur when using an aluminium container, stop and transfer the food to a microwave-safe container.

Suitable containers for microwave ovens

- Pieces of aluminium foil

For even defrosting and to avoid overcooking unevenly shaped cuts of meat, poultry or fish, small pieces of aluminium foil may be used to mask wingtips or other thin parts for the last few minutes of the programme.

Make sure that the aluminium foil is at least 2 cm from the oven walls at all times. It must not touch the walls.

- Metal meat skewers or clamps

These should only be used if they are very small in comparison to the size of the cut of meat.

Glassware

Heat-resistant glass or ceramic glass are ideal for use in the microwave oven.

Crystal glass contains lead which could cause the glass to crack. Glass dishes with a milled rim are also subject to this risk. Both are unsuitable.

Porcelain

Porcelain is a suitable material.

Do not use porcelain with gold or silver edging or items with hollow knobs or handles, as insufficient ventilation may cause pressure.

Earthenware

Decorated earthenware is only suitable if the decoration is beneath an all-over glaze.

Earthenware can get very hot, and may crack.

Glazes and colours

Some glazes and colours contain metal. This makes them unsuitable for use in a microwave oven.

Plastics

Plastic containers must only be used for microwave mode alone. Plastics must be heat-resistant to a minimum of 110 °C.

Otherwise the plastic may melt and fuse with the food.

Special plastic utensils designed for use in microwave ovens are available from good retail outlets.

Melamine is not suitable as it absorbs energy and heats up. When purchasing plasticware, make sure that it is suitable for use in a microwave oven.

Disposable containers, such as trays made from polystyrene, can only be used for very short timed warming and reheating of food.

Plastic boiling bags can be used for cooking and reheating.

They should be pierced beforehand so that steam can escape. This prevents a build-up of pressure and reduces the risk of the bag bursting.

Suitable containers for microwave ovens

Roasting bags and **tubes** can also be used. Roasting tubes should be about 40 cm longer and roasting bags about 20 cm longer than the food being roasted, and carefully tied with string. Turn the ends over and secure them. The bag should be pierced according to the manufacturer's instructions.

Do not use metal clips, plastic clips containing metal parts, or paper ties containing wire. There is a danger that they will ignite when heated.

Wood

Wooden dishes are not suitable. Moisture contained in the wood evaporates when exposed to microwave energy, causing the wood to dry and crack.

Disposable containers

Only those plastic disposable containers which are specified by the manufacturer as suitable for use in a microwave oven may be used.

Do not leave the oven unattended when reheating or cooking food in disposable containers made of plastic, paper or other inflammable materials.

Disposable containers are not always recyclable or bio-degradable.

Testing dishes for their suitability

If in doubt as to whether glass, earthenware or porcelain plates or dishes are suitable for use in a microwave oven, a simple test can be performed:

- Place the item you wish to test in the centre of the oven, fill a suitable glass with water and also place this in the oven.
- Close the door.
- Turn the power selector to 800 Watts.
- Enter a time of 30 seconds with the time selector.
- Press START.

At the end of the test, the water in the glass should be warm and the dish cool. If the dish is hot and the water cold it would be unwise to use the dish.

If a crackling noise is heard accompanied by sparks during the test, switch the appliance off immediately (press button Stop/C twice).

Any crockery which causes this reaction is unsuitable for use in the microwave oven.

If any doubt exists about the suitability of containers, please contact the supplier.

This test cannot be used to check whether items with hollow knobs or handles are suitable for use in a microwave oven.

Suitable containers for microwave ovens

The cover

- prevents too much steam escaping, especially when cooking foods which need longer to cook, such as potatoes.
- shortens and evens out the cooking process.
- prevents food from drying out.
- prevents any loss of aroma.
- helps keep the oven interior clean.



Always cover food with the cover supplied.

Alternatively, use lids or covers made of microwave-safe glass or plastic, or use a clingfilm recommended for use in a microwave oven (pierce as instructed by the manufacturer).

Normal clingfilm can distort.

Sealed glass containers, such as jars of baby food must be opened before they are placed in the oven.

Do not use a lid or cover if

- food coated with breadcrumbs is being cooked
- cooking meals which are to be given a crisp finish.

The cover supplied may only be used in microwave-solo operation.

The cover can only withstand temperatures of up to 110 °C. Higher temperatures generated by grilling or fan heat could cause the plastic to distort and fuse with the food.

Before using for the first time

Important:

After unpacking, let the appliance stand for approx. 2 hours at room temperature after transporting it to its final location before connecting it to the mains.

This is important for the correct electronic functioning of the appliance.

- Remove all the packaging materials from the appliance.

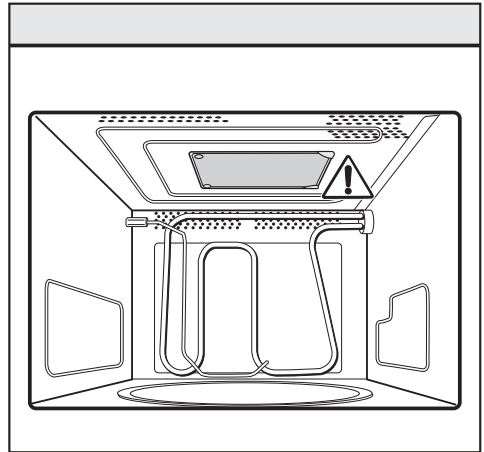

Do not remove the cover to the microwave outlet inside the oven.

- Check the appliance for any damage.

Do not use the microwave if

- the door is warped.
- the door hinges are loose.
- holes or cracks are visible in the casing, the door, the door seal or the oven interior walls.

Operating the appliance with this type of damage will result in microwave leakage and present a hazard to the user.

- Clean the inside of the oven and all the accessories with warm water and a little washing up liquid applied with a well wrung-out soft sponge or cloth.

Setting the time of day

- Connect the appliance to the mains electricity supply.

12:00 flashes in the display for approx. 4 seconds and the ⊖ symbol lights up.

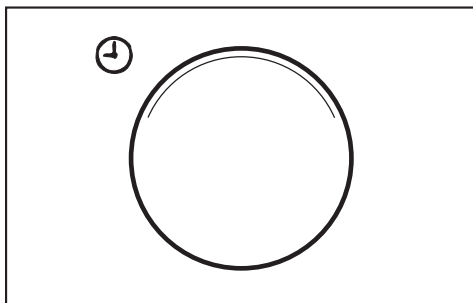

- Use the time selector to set the time of day.

The time set is automatically registered by the appliance after 4 seconds. The colon between hours and minutes flashes.

Altering the time of day

- Press the ⊖ button.
The time of day flashes in the display and the ⊖ symbol lights up.
- Use the time selector to alter the time of day.

Switching off the time of day display

- Press the ⊖ button twice.
The display area goes dark.

Pressing the ⊖ button twice will bring the time of day back in the display.

Night time

The time of day display can be set to switch itself off from 23:00 hrs until 04:00 hrs.

Setting the time of day display to switch off at night

- Press and hold in the Stop/C button, and at the same time press the ⊖ button.

ON appears in the display.

The appliance can still be operated.

To switch the display back on:

- Press and hold the Stop/C button, and at the same time press the ⊖ button.

OFF appears in the display.

Operation

To open the door

- Press the  button to open the door.

If the microwave oven is being used, opening the door will interrupt the cooking programme.

Placing the dish in the oven

Ideally the container should be placed in the middle of the oven.

Turntable

Do not operate the microwave without the turntable in place.

The turntable helps the food to cook, reheat or defrost more evenly.

The turntable starts turning automatically when the appliance is operated.

Do not cook, reheat or defrost food directly on the turntable. Check that the dish is not larger in size than the turntable.

If possible, do not switch the turntable off.

Only switch it off if there is a danger of something blocking it, e.g. a large dish which is wider than the turntable. (Press the  button to switch the turntable off).

Stir the food during the cooking time or turn the dish so that it heats up evenly.

To close the door

- Push the door firmly shut.

Press the START button again to resume an interrupted cooking programme.

The appliance will not start again if the door has not been closed properly.

Starting a programme

Use the appropriate selector to choose the microwave power level and the time. It does not matter which is chosen first.

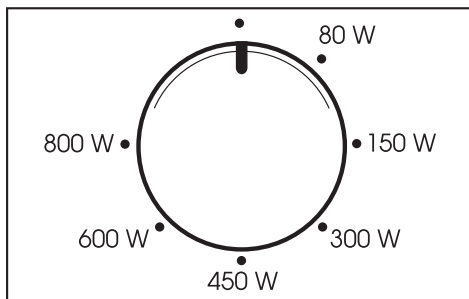

- Turn the power selector to the required level.

There is a choice of 6 power levels. The higher the power level, the more microwaves reach the food.

When heating up food which cannot be stirred or turned during cooking, as with a plated meal, it is best to use a lower microwave power level.

This ensures the heat is distributed evenly. Heat for long enough to cook the food properly.

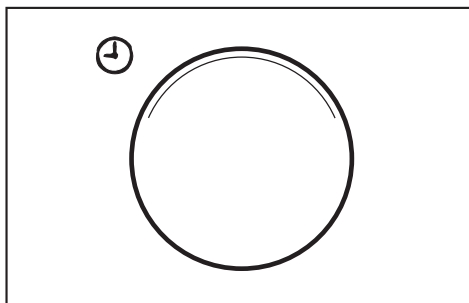

- Use the time selector to enter the required time.
Any time between 5 seconds and 60 minutes can be selected.

The time required depends on:

- the initial temperature of the food.
Food taken from the refrigerator will need longer to reheat or cook than food already at room temperature.
- the type and texture of the food.
Fresh vegetables contain more water and cook more quickly than stored vegetables.
- the frequency of stirring or turning the food.
Frequent stirring or turning heats the food more evenly, and it is therefore ready in a shorter time.
- the amount of food.
As a general rule, allow approx. time and a half for double the quantity. For a smaller quantity, possibly shorten the time but ensure food is cooked thoroughly.
- the shape and material of the container.

Operation

- Press the START button to start the programme.
The interior lighting comes on.

A programme can only be started if the door is closed.

Interrupting or re-starting a programme

... To interrupt a programme:

- Press the Stop/C button, or open the appliance door.
The time stops counting down.

... To continue the programme:

- Close the door and press START.
The programme continues.

Altering the settings

If you discover after starting a programme that . . .

. . . the **microwave power level** is too high or too low, you can

- select a new level.

. . . the **time** set is too short or too long, you can

- interrupt the programme (press the Stop/C button once), use the time selector to set a new time and continue the programme (press the START button).

To cancel a programme

- Press the Stop/C touch control twice.

At the end of a programme

An audible tone will sound when the cooking programme is complete. The oven interior lighting goes out.

- If you want to stop the audible tone, press any button.

Automatic warming function

The warming function will switch on automatically for a maximum of 15 minutes, approx. 2 minutes after the end of a cooking programme which has used at least 450 watts, providing that the door remains closed and no buttons are pressed.

H:H lights up in the display. If the turntable was engaged it will start turning. If it was turned off during the cooking process it will not come on.



Opening the door or pressing the Stop/C button while the warming function is in progress cancels the function.

The warming function cannot be set as a separate function.

Quick start (programmable)

Pressing the START button  is sufficient to set the appliance operating on maximum power.

Three set times are stored in the memory:

- 30 secs: Press START  once
- 1 min: Press START  twice
- 2 min: Press START  three times

Pressing the START  button four times in succession will bring back the first stored time and so on.

Programming times

To alter the set times:

- Use the START  button to select the time you want to reprogramme (press once, twice or three times) and hold the START  button pressed in.
- While holding the START button pressed in, alter the time with the time selector.
The altered programme runs when the START  button is released.

An interruption to the power supply will cancel any altered programmed times and they will need to be entered again.

Safety lock

The safety lock prevents the appliance being used by children, for example.

To activate the safety lock

- Press and hold the  button in until an audible tone sounds and the key symbol appears in the display:



The key symbol will go out after a short time.

The key symbol reappears whenever any button or one of the rotary selectors is operated.

After an interruption to the mains power supply, the safety lock will need to re-activated.





To cancel the safety lock

- Press the  button again and hold it pressed in until an audible tone sounds.



Operation

Minute minder

The minute minder can be used to time any activity in the kitchen, e.g. boiling eggs. The time set counts down in one second steps.

- Press the  button.
0:00 flashes in the display and the  symbol lights up.
- Use the time selector to set the minute minder time you require.
- Press the START button.
- At the end of the minute minder time, an audible tone sounds. The time of day reappears and the  symbol flashes.
- Press the Stop/C button once and the  symbol disappears.

Altering a minute minder entry

- Press the Stop/C button.
The minute minder time is interrupted. The time left and the  symbol light up in the display. The Start symbol  flashes.
- Use the time selector to alter the minute minder time and then press the START button.

There are three grill settings. It is possible to change from one grill setting to another during operation.

Do not operate the grill if it has been lowered, e.g. for cleaning. This would damage it.

If the total grilling time required is less than 15 minutes, the grill should be pre-heated for at least 5 minutes before placing food under the grill.

Flat pieces of fish and meat should usually be turned half way through grilling for even results. Larger pieces should be turned several times.

Grilling times depend on the type and thickness of the food and on the user's preference for a rare or well-cooked result.

- Place food on the rack or in the glass tray. If placed on the rack, the glass tray can be placed under the rack to catch any oils or cooking juices.

To ensure even results it is best to leave the turntable engaged during grilling.

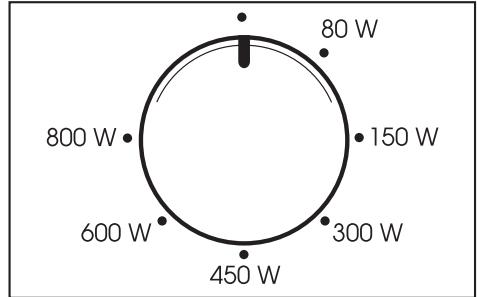

- Turn the power selector to the point (12 o'clock position).

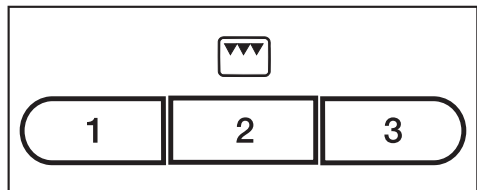

- Select the grill setting you want (1, 2 or 3). The grill symbol  and the figure indicating which grill setting has been selected light up in the display. 0:00 flashes in the display.
- Select a time using the time selector.
- Press the START button. An audible tone will sound at the end of the process.

The rack and glass tray become hot during use. Danger of burning!

The time entered can be changed during operation. Interrupt the process by pressing the Stop/C button and change the time. To continue press the START button.

Grilling

The glass tray and grill rack will be easier to clean if washed in soapy water immediately after grilling.

Microwave with grill Combination mode

The grill can be switched on at the beginning of a process or during cooking. This is useful for example to brown the top of a dish. It can also be switched off during cooking.

- Press the relevant grill button to select or deselect the grill setting.

The setting selected can also be changed during grilling.

Select the following microwave power levels to reheat food:

Drinks 800 watts

Food 600 watts

Food for babies and toddlers. 450 watts

We do not recommend heating or reheating foods or drinks for babies or young children in the microwave oven. Any decision to do this is the responsibility of the user, and should only be done with the utmost care. Pasteurised or sterilised cooked food should be gently heated using 450 watts, and tasted to make sure it is not too hot for a baby's palate before serving. When reheating other food or drink, heat to a high temperature and allow to cool to a suitable heat for eating. For formula milk follow the manufacturer's instructions.

Tips on reheating

Always use a lid or cover for reheating food, except when a drier finish is needed, e.g. breaded poultry/meat.

Always remove the lids from jars, especially jars of baby food. Remove the rubber teat and screw cap before warming baby bottles. When reheating liquids, place the boiling rod supplied with the appliance into the cup or glass. Never reheat hard boiled eggs in a microwave oven, even without the shell. The eggs can burst.

Food taken straight from the refrigerator will take longer to reheat than food stored at room temperature. The time required depends on the nature of the food, its initial temperature and the amount to be cooked.

Always ensure that food is sufficiently cooked or reheated.

If in any doubt that a sufficiently high temperature has been reached, continue reheating for a little longer.

Stir or turn food from time to time during cooking. Stir the food from the outside towards the middle, as food heats more quickly from the outside.

After reheating

Be careful when removing a dish from the oven. It may be hot.

Although heat is not normally produced in the container itself by the microwaves (apart from stoneware), heat transfer from the food to the container may be considerable, making the container itself hot.

Allow food to stand for a few minutes at room temperature at the end of reheating to enable the heat to spread evenly throughout the food.

After heating food, especially food for babies and small children, stir the food or shake the container and check that the temperature does not pose any danger. Double check after it has been left to stand.

Cooking

Place the food in a microwave-proof dish and cover it.

When cooking it is a good idea to select a power level of 800 watts to start with and then when the food is hot reduce the power level to 450 watts for more gentle continued cooking.

For dishes such as **rice or semolina pudding** first select a power level of 800 watts and then reduce it to 150 watts for simmering.

Tips on cooking

Vegetable cooking times depend on the texture of the vegetable.

Fresh vegetables contain more water than vegetables which have been stored and usually cook more quickly. Add a little water to vegetables which have been kept stored.

Food taken straight from the refrigerator requires longer to reheat than food stored at room temperature.

Stir or turn food from time to time during cooking to help it cook more evenly.

Ensure that foods such as meat and fish are thoroughly cooked for an appropriate length of time.

Food with a thick skin or peel, such as tomatoes, sausages, jacket potatoes and aubergines, should be pierced or the skin cut in several places before cooking to allow steam to escape and prevent the food from bursting.

Eggs can only be cooked in their shells in the microwave oven in a specially designed egg-boiling device available from specialist shops.

Eggs can burst, even after they have been taken out of the oven.

Eggs can be cooked without their shells in the microwave oven only if the yolk membrane has been punctured several times first.

The pressure could otherwise cause the egg yolk to explode.

After cooking

Be careful when removing a dish from the oven. It may be hot.

Although heat is not normally produced in the container itself by the microwaves (apart from stoneware), heat transfer from the food to the container may be considerable, making the container itself hot.

Allow food to stand for a few minutes at room temperature at the end of cooking to enable the heat to spread evenly throughout the food.

Defrosting / Defrosting and reheating or cooking

Defrosting

Select the following microwave power settings to reheat food:

- 150 W:
for defrosting delicate foods e.g. milk, bread, cake, fruit etc.
- 80 W:
for defrosting very delicate foods, e.g. cream, butter, cheese and gateaux made with cream or butter cream.

Remove the food from its packaging and place in a microwave-proof container. Do not cover. Turn, stir or separate the food about half-way through the defrosting time.

To defrost meat, unpack the frozen meat and lay it on an upturned plate in a glass or china container so that the meat juice can run off and be collected. Turn half-way through defrosting.

After defrosting

Allow the food to stand at room temperature for a few minutes after defrosting to enable the heat to spread evenly throughout the food.

Defrosting followed by reheating or cooking

Deep-frozen food can be defrosted and immediately reheated or cooked.

After defrosting, select 800 watts followed by 450 watts.

Remove the food from its packaging and place in a covered microwave-proof dish for defrosting and reheating or cooking. Exception: Minced meat should be left uncovered while cooking.

Soups, stew and vegetables should be stirred several times during the process. Carefully separate and turn slices of meat half-way through the programme. Turn pieces of meat and fish at the half-way stage.

Deep-frozen pre-cooked meals in cardboard trays which, according to manufacturer's instructions are suitable for use in a conventional oven, are microwave-safe.

After defrosting followed by reheating or cooking

Allow the food to stand at room temperature for a few minutes to enable the heat to spread evenly throughout the food.

Other uses

Melting margarine, butter

Melt 100 g at 450 watts uncovered for approx. 1-1 $\frac{1}{2}$ minutes.

Melting chocolate

Break 100 g into pieces, melt at 450 watts uncovered for approx. 2 minutes.

Dissolving gelatine

Add water according to manufacturer's instructions given on the packet and melt at 450 watts for approx. $\frac{1}{2}$ - 1 minute, stirring occasionally.

Preparing flan topping/jelly glaze

Gently heat 1 sachet + $\frac{1}{4}$ litre liquid at 450 watts uncovered for approx. 4-5 minutes, stirring occasionally.

Proving dough

(500 g flour) cover and leave to rise for approx. 8-10 minutes at 80 watts.

Skinning tomatoes

Cut 3 tomatoes crosswise, drop into water and heat at 450 watts for approx. 2 minutes. The skin can now be peeled away easily. Take care, as the tomatoes may be very hot.

Disconnect the microwave oven from the power supply before cleaning (e.g. switch off at the socket and remove the plug).

- A microfibre E-Cloth is available from the Miele UK Spare Parts Department which is suitable for cleaning surfaces such as stainless steel, glass, plastic and chrome without the use of chemicals. It can be washed 300 times.

Oven housing, cavity and door interior

The housing, cavity and door interior can be cleaned using a damp cloth with a little washing up liquid or a mild detergent and water. Wipe dry with a soft cloth.

For more heavy soiling, heat a heat-proof glass of water for 2 to 3 minutes until the water begins to boil. The steam will collect on the walls and soften the soiling.

The oven interior can now be wiped clean using a little washing up liquid if necessary.

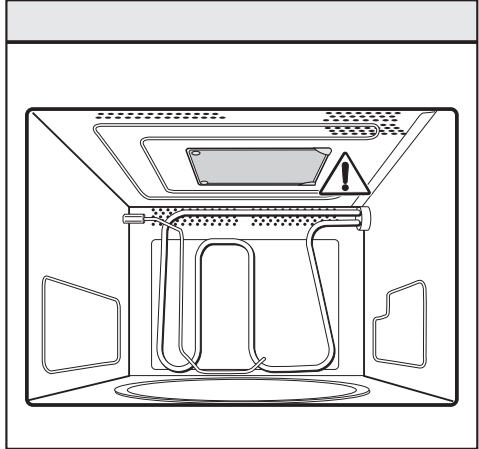

Do not remove the cover to the microwave outlet inside the oven.

Neither water nor any small particles should be allowed to penetrate the vents in the housing.

Wring out cloths before using them to wipe out the oven to avoid moisture getting into the openings.

Do not use abrasive cleaners on the oven, as these scratch the surface.

Stainless steel surfaces can be cleaned with a proprietary non-abrasive cleaner for stainless steel, following the instructions given by the manufacturer on the packaging.

To neutralise odours in the microwave oven, put a cup of water with some lemon juice in the oven and simmer for a few minutes.

Cleaning and care

The door and door seal should be kept clean at all times and checked at regular intervals for any signs of damage.

If any damage is noticed, the appliance should not be used until the fault has been rectified by a Miele authorised and trained service technician.

To clean the inside of the oven:

Wait until the grill element has cooled down before lowering it to avoid the danger of being burnt.

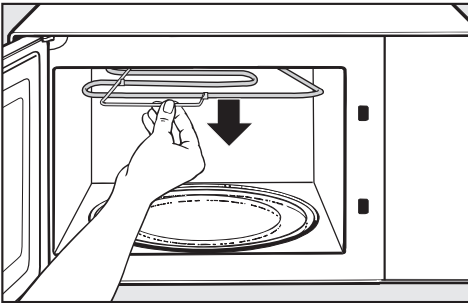

- Lower the grill element gently.

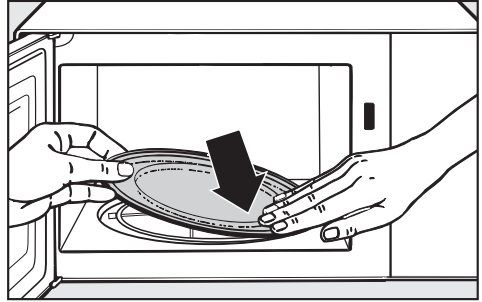

- Remove the turntable, and wash in the dishwasher or by hand and rinse in water.
- Always keep the roller ring underneath it clean as well as the oven floor to enable the turntable to turn smoothly.
- Clean the area between the turntable and the carrier. The carrier is located in the middle of the oven floor and can be removed for cleaning.

Do not turn the carrier manually, as this could damage the drive motor.

Appliance front and control panel

- All external surfaces and controls can be cleaned using warm water with a little washing up liquid applied with a soft sponge or cloth.
- Wipe the surfaces dry using a soft cloth.

To prevent the risk of scratches and damage to the surface of the control panel or glass or stainless steel front of your appliance, please pay particular attention to the following cleaning instructions.

Controls

The controls are susceptible to scratches and abrasions and may suffer discolouration or damage if soiling is left on them for too long. Remove any soiling straight away.

Avoid:

- cleaning agents containing soda, acids or chlorides,
- abrasive cleaning agents, e.g. powder cleaners and cream cleaners,
- abrasive sponges, e.g. pot scourers or sponges which have been previously used with abrasive cleaning agents,
- stainless steel cleaners,
- oven sprays.

Glass fronts

The appliance front is susceptible to scratches and abrasions.

Avoid:

- abrasive cleaning agents, e.g. powder cleaners and cream cleaners,
- abrasive sponges, e.g. pot scourers or sponges which have been previously used with abrasive cleaning agents,
- oven sprays.

Stainless steel fronts

The appliance front is susceptible to scratches and abrasions.

Stainless steel surfaces can be cleaned with a proprietary non-abrasive cleaning agent designed specifically for use on stainless steel. N.B. Do not use it on the controls.

Avoid:

- cleaning agents containing soda, acids or chlorides,
- abrasive cleaning agents, e.g. powder cleaners and cream cleaners,
- abrasive sponges, e.g. pot scourers or sponges which have been previously used with abrasive cleaning agents.

To help prevent re-soiling, proprietary conditioning agents for stainless steel can also be used. Apply sparingly following the direction of the grain. Wipe dry with a soft cloth.

Cleaning and care

Accessories supplied

Boiling rod

The boiling rod can be washed in a dishwasher.

Cover

Wash and dry the cover after each use. The cover can be washed in a dishwasher. However, discolouration caused by natural dyes, e.g. from carrots, tomatoes or ketchup, may occur.

This discolouration is irreversible but does not affect the stability of the cover.

Rack

Wash and dry the rack after each use. It is dishwasher-proof, or can be washed by hand in hot water with a little washing up liquid. Remove stubborn soils with a stainless steel cleaner.

Glass tray

The glass tray can be washed by hand using a solution of hot water and washing up liquid or in a dishwasher. Do not use abrasive cleaning agents.

Repairs to this appliance should only be carried out by a Miele approved service technician in accordance with local and national safety regulations. Repairs and other work by unqualified persons could be dangerous. The manufacturer cannot be held liable for unauthorised work.

Some minor problems can be corrected without contacting the Service Department.

What to do if . . .

. . . a programme will not start

Check whether,

- the appliance door is closed properly.
- the appliance is plugged into the mains supply and switched on at the socket.
- the mains fuse has blown (call a qualified electrician or the Service Department if it has. See After Sales Service).

. . . a noise can be heard after a cooking programme

This is not a fault.

The cooling fan will continue to run for a while after the oven has been switched off to dispel any moisture from the oven and prevent it settling on the control panel or surrounding furniture. It will switch off automatically.

. . . the display does not light up

Check whether,

- the time of day display has been switched off (press the ⊖ button twice).
- the time of day display has been programmed to switch off at night.

. . . the turntable does not turn smoothly

- Check whether the area underneath the roller ring is clean.
- Check whether the surfaces between the turntable and the carrier are clean.
Remove any soiling.

. . . food is not adequately defrosted, heated or cooked at the end of the selected time

- Check whether the correct power level was selected for the time set.
The lower the power level, the longer the time required.
- Check whether the programme has been interrupted and not restarted.

Problem solving guide

... strange noises are heard when the microwave oven is being used

Check whether,

- the food is covered with aluminium foil.
If so, remove it.
- Sparks are being created by the use of crockery with a metallic finish. See notes on suitable types of containers.

... the time of day in the display is not accurate

If there has been a power cut the time automatically switches back to 12.00. The time of day needs to be re-set.

- Set the correct time of day.

... food cools down too quickly

In the microwave oven, food begins to cook from the outside first, the inside of the food relying on the slower conduction of heat.

If food is cooked at a high power level, it is possible that the heat may not have reached the centre of the food, so it is hot on the outside but cold in the centre. During standing time heat is transferred to the centre of the food. This may leave the food warm in the middle but cool on the outside. When reheating food with different densities, such as plated meals, it is therefore sensible to start with a low power level and lengthen the time required.

... the microwave switches itself off during a cooking, reheating or defrosting programme

There may be insufficient air circulation.

Check whether,

- the air inlet is blocked.
- an object is blocking the ventilation outlets.
- anything is blocking the gap between the base of the appliance and the worktop surface.

Remove any objects if necessary. The appliance switches off automatically in cases of overheating. Cooking can be continued after a cooling-down period.

If the microwave oven switches itself off repeatedly, please call the Miele Service Department.

If it is not possible to remedy a fault by following the instructions given above, on no account open the appliance casing.

This microwave oven should only be repaired by a suitably qualified technician trained by Miele.

In the event of any faults which you cannot remedy yourself, or if the appliance is under guarantee, please contact

- your Miele dealer or
- the Miele Service Department (see back cover for contact details).

When contacting the Service Department, please quote the model and serial number of your appliance given on the data plate which is located externally on the rear wall of the appliance.

Telephone calls may be monitored and recorded to improve our service.

Electrical connection

Before connecting the appliance, ensure that it has not been damaged in any way. Do not use a damaged appliance.

Electrical connection U.K.

All electrical work should be carried out by a suitably qualified and competent person in accordance with national and local safety regulations.

The appliance is supplied with a cable and moulded plug ready for connection to a 230-240 V/50 Hz a.c. single phase supply.

The voltage, rated load and fusing are given on the data plate which is located externally on the rear wall of the appliance. Please ensure that these match the household mains supply.

Connection should be made via a fused connection unit or a fused plug and a suitable switched socket which complies with national and local safety regulations, and the on/off switch should be easily accessible after the appliance has been installed.

If the socket is not accessible after installation (depending on country) an additional means of disconnection must be provided for all poles.

When switched off there must be an all-pole gap of 3 mm in the isolator switch (including switch, fuses and relays acc. to EN 60335).

For extra safety it is advisable to install a residual current device with a trip current of 30 mA (in accordance with DIN VDE 0664, VDE 0100 Section 739).

If the appliance is connected via an isolator switch the plug must be cut off and rendered useless.

Important

The wires in the mains lead of this appliance are coloured in accordance with the following code:

Green/yellow = Earth

Blue = Neutral

Brown = Live

If the colours of the wires in the mains lead of this appliance do not correspond with the markings identifying the terminals in your plug, proceed as follows:

The wire coloured green and yellow must be connected to the terminal in the plug which is marked with the letter E or by the earth symbol \perp or coloured green or green and yellow.

The wire coloured blue must be connected to the terminal marked with the letter N or coloured black. The wire coloured brown must be connected to the terminal marked with the letter L or coloured red.

WARNING
THIS APPLIANCE MUST BE
EARTHED

Non-rewireable plugs BS 1363

If this appliance is fitted with a non-rewireable plug, the following information applies:

if the socket outlets are not suitable for the plug supplied with this product, it must be cut off and an appropriate plug fitted.

The fuse carrier and fuse should be removed from the old plug and disposed of. The old plug should then be disposed of and on no account be inserted into any socket elsewhere in the house (electric shock hazard).

The fuse cover must be re-fitted when changing the fuse, and if the fuse cover is lost the plug must not be used until a suitable replacement is obtained. The colour of the correct replacement cover is that of the coloured insert in the base of the plug, or the colour that is embossed in words on the base of the plug, (as applicable to the design of plug fitted).

Replacement fuses should be ASTA approved to BS 1362 and have the correct rating. Replacement fuses and fuse covers may be purchased from your local electrical supplier or Miele service agent.

Installation

If the connection cable is damaged it must be replaced by a special cable which must be fitted by a suitably qualified and competent Miele approved service technician. Please consult the Miele Service Department.

Do not position the appliance too close to adjacent furniture. A ventilation gap of at least 5 cm is required all round the appliance. The ventilation gap above the appliance should be at least 14 cm.

When installing the appliance ensure there is sufficient ventilation underneath and to the rear of the appliance.

Do not place any objects on the ventilation outlets or block the gap between the base of the appliance and the worktop surface

The microwave oven can be:

- placed on a worktop.
- built under a wall unit by using the appropriate building-under frame.
- built into a wall unit or tall unit by using the appropriate building-in frame.

Building-in and building-under frames are available from your Miele Dealer or the Miele Spare Parts Department. They are supplied with fitting instructions.

Technical data

M 613 G	
Voltage	220-240 V, 50 Hz
Rated load	see data plate
Power levels	6 (80/150/300/450/600/800 watts)
Fuse rating (UK)	13 A
Timer	60 minutes
Freestanding appliance	
External dimensions H x W x D in mm:	296 x 440 x 330
Net weight	16 kg

**United Kingdom:**

Miele Co. Ltd.
Fairacres, Marcham Road
Abingdon, Oxon, OX14 1TW
tel. Abingdon (01235) 554455
Service Office: (01235) 554466
fax (01235) 554477
Internet: www.miele.co.uk

Ireland:

Miele Ireland Ltd.
Broomhill Road, Tallaght, Dublin 24
Tel: (01) 46 10 710, Fax: (01) 46 10 797
Email: info@miele.ie
Internet: <http://www.miele.ie>

Australia:

Miele Australia Pty. Ltd.
A.C.N. 005635398
1 Gilbert Park Drive
Knoxfield, VIC 3180
Telephone: (03) 9764 7100
Fax: (03) 9764 7129
Internet: www.miele.com.au

Distributor New Zealand:

Steelfort Engineering Company. Ltd.
500 Rangitikei Street
Palmerston North, Priv. Bag 11045, NZ
Telephone: (06) 350 1350
Fax: (06) 356 1507

South Africa:

Miele (Pty) Ltd
304 Tungsten Road
Strijdom Park 2194
P.O.Box 1654, Randburg 2125
Tel. (011) 793-7452
Telefax (011) 793-7447
E-mail: info@miele.co.za
Internet: www.miele.co.za

Singapore:

Miele Southeast Asia
Miele Pte. Ltd.
163 Penang Road
04 - 02/03 Winsland House II
Singapore 238463
Tel : +65-67351191
Fax: +65-67351161
Email: mielesea@miele.com.sg

Hong Kong:

Miele (Hong Kong) Limited
AIA Plaza, Room 401, 4th Floor
18 Hysan Avenue
Causeway Bay
Hong Kong
Tel.: (852) 2610 1331
Fax: (852) 2610 1013
E-mail: mielehk@netnavigator.com