

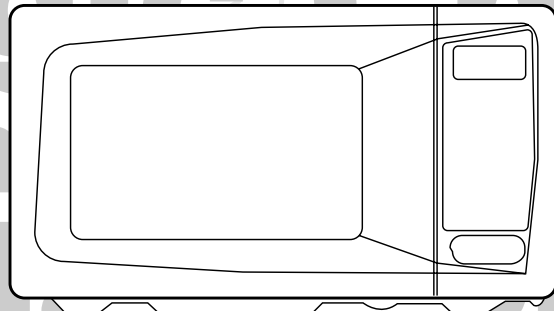

MICROWAVE OVEN

MCD795SW

OPERATING
INSTRUCTIONS



Before operating this oven, please read these instructions completely.

TM

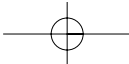

PRECAUTIONS TO AVOID POSSIBLE EXPOSURE TO EXCESSIVE MICROWAVE ENERGY

(a) Do not attempt to operate this oven with the door open since open-door operation can result in harmful exposure to microwave energy. It is important not to defeat or tamper with the safety interlocks.

(b) Do not place any object between the oven front face and the door or allow soil or cleaner residue to accumulate on sealing surfaces.

(c) Do not operate the oven if it is damaged. It is particularly important that the oven door close properly and that there is no damaged to the: (1) door (bent), (2) hinges and latches(broken or loosened), (3) door seals and sealing surfaces.

(d) The oven should not be adjusted or repaired by anyone except properly qualified service.

TABLE OF CONTENTS

- IMPORTANT SAFETY INSTRUCTIONS.....2
- READ CAREFULLY AND KEEP FOR FUTURE REFERENCE2
- FEDERAL COMMUNICATIONS COMMISSION RADIO FREQUENCY INTERFERENCE STATEMENT3
- GROUNDING INSTRUCTIONS.....3
- INSTALLATION4
- FEATURES DIAGRAM.....5
- FEATURES DIAGRAM (CONTINUED)6
- OPERATION PROCEDURE7
- CONTROLS.....8
 - SENSOR COOK.....8
 - AUTO DEFROST.....9
 - TIME DEFROST10
 - TIME COOK11
 - KITCHEN TIMER12
 - SPEEDY COOK13
 - MINUTE PLUS14
 - CLOCK14
 - HELP15
 - NIGHT LIGHT16
 - TO STOP THE OVEN WHILE THE OVEN IS OPERATING16
- CARE OF YOUR MICROWAVE OVEN.....17
- QUESTIONS AND ANSWERS18
- BEFORE YOU CALL FOR SERVICE19
- CARE AND CLEANING19
- SPECIFICATIONS.....19
- COOKING INSTRUCTIONS20
- USE YOUR MICROWAVE OVEN SAFELY21
- ARCING21
- MICROWAVING PRINCIPLES22
- HOW MICROWAVES COOK FOOD22
- CONVERSION CHARTS22
- COOKING TECHNIQUES.....23
- DEFROSTING GUIDE.....24
- COOKING & REHEATING CHART25
- VEGETABLE CHART.....27
- RECIPES28

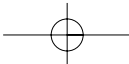

IMPORTANT SAFETY INSTRUCTIONS

When using electrical appliances, basic safety precautions should be followed, including the following:

WARNING-To reduce the risk of burns, electric shock, fire, injury to persons or exposure to excessive microwave energy:

1. Read all instructions before using the appliance.
2. Read and follow the specific "PRECAUTIONS TO AVOID POSSIBLE EXPOSURE TO EXCESSIVE MICROWAVE ENERGY" found on page 1.
3. This appliance must be grounded. Connect only to properly grounded outlet. See "GROUNDING INSTRUCTIONS" found on page 3.
4. Install or locate this appliance only in accordance with the provided installation instructions.
5. Some products such as whole eggs and sealed containers - for example, closed glass jars-are able to explode and should not be heated in this oven.
6. Use this appliance only for its intended use as described in this manual. Do not use corrosive chemicals or vapors in this appliance. This type of oven is specifically designed to heat, cook, or dry food. It is not designed for industrial or laboratory use.
7. Only allow children to use the oven without supervision when adequate instructions have been given so that the child is able to use the oven in a safe way and understands the hazards of improper use.
8. Do not operate this appliance if it has a damaged cord or plug, if it is not working properly, or if it has been damaged or dropped.
9. This appliance should be serviced only by qualified service personnel.
Contact nearest authorized service facility for examination, repair or adjustment.
10. Do not cover or block any openings on the appliance.
11. Do not store this appliance outdoors. Do not use this product near water — for example, near a kitchen sink, in a wet basement, near a swimming pool, or similar locations.
12. Do not immerse cord or plug in water.
13. Keep cord away from heated surfaces.
14. Do not let cord hang over edge of table or counter.
15. Either:
 - a) When cleaning surfaces of door and oven that comes together on closing the door, use only mild, non-abrasive soaps or detergents applied with a sponge or soft cloth . or
 - b) When separate cleaning instructions are provided, See door surface cleaning instructions on.
16. To reduce the risk of fire in the oven cavity:
 - a) Do not overcook food. Carefully attend appliance when paper, plastic, or other combustible materials are placed inside the oven to facilitate cooking.
 - b) Remove wire twist-ties from paper or plastic bags before placing bag in oven.
 - c) If materials inside the oven ignite, keep oven door closed, turn oven off, and disconnect the power cord, or shut off power at the fuse or circuit breaker panel.
 - d) Do not use the cavity for storage purposes. Do not leave paper products, cooking utensils, or food in the cavity when not in use.
17. Do not use this microwave oven to heat corrosive chemicals (for example, sulfides and chlorides). Vapours from such corrosive chemicals may interact with the contact and springs of the safety interlock switches thereby rendering them inoperable.
18. Keep the waveguide cover clean at all times.
Wipe the oven interior with a soft damp cloth after each use. If you leave grease or fat anywhere in the cavity it may overheat, smoke or even catch fire when next using the oven.
19. Never heat oil or fat for deep frying as you cannot control the temperature and doing so may lead to overheating and fire.
20. Liquids, such as water, coffee, or tea are able to be overheated beyond the boiling point without appearing to be boiling due to surface tension of the liquid. Visible bubbling or boiling when the container is removed from the microwave oven is not always present. **THIS COULD RESULT IN VERY HOT LIQUIDS SUDDENLY BOILING OVER WHEN A SPOON OR OTHER UTENSIL IS INSERTED INTO THE LIQUID.**
To reduce the risk of injury to persons:
 - a) Do not overheat the liquid.
 - b) Stir the liquid both before and halfway through heating it
 - c) Do not use straight-sided containers with narrow necks.
 - d) After heating, allow the container to stand in the microwave oven for a short time before removing the container.
 - e) Use extreme care when inserting a spoon or other utensil into the container.
21. Do not operate the oven without the glass tray in place. Be sure it is properly sitting on the rotating base.

SAVE THESE INSTRUCTIONS

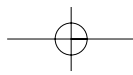

FEDERAL COMMUNICATIONS COMMISSION RADIO FREQUENCY INTERFERENCE STATEMENT

WARNING:

This equipment generates and uses ISM frequency energy and if not installed and used properly, that is in strict accordance with the manufacturer's instructions, may cause interference to radio and television reception.

It has been type-tested and found to comply with limits for an ISM Equipment pursuant to part 18 of FCC Rules, which are designed to provide reasonable protection against such interference in a residential installation.

However, there is no guarantee that interference will not occur in a particular installation.

If this equipment does cause interference to radio or television reception, which can be determined by turning the equipment off and on, the user is encouraged to try to correct the interference by one or more of the followings.

- Reorient the receiving antenna of radio or television.
- Relocate the Microwave oven with respect to the receiver.
- Move the microwave oven away from the receiver.
- Plug the microwave oven into a different outlet so that microwave oven and receiver are on different branch circuits.

THE MANUFACTURER is not responsible for any radio or TV interference caused by UNAUTHORIZED MODIFICATION to this microwave oven. It is the responsibility of the user to correct such interference.

GROUNDING INSTRUCTIONS

This appliance must be grounded. In the event of an electrical short circuit, the grounding plug reduces the risk of electric shock by providing an escape wire for electric current. This appliance is equipped with a cord having a grounding wire with a grounding plug. The plug must be plugged into an outlet that is properly installed and grounded.

WARNING:

Improper use of the grounding can result in a risk of electric shock.

Consult a qualified electrician or serviceman if the grounding instructions are not completely understood, or if doubt exists as to whether the appliance is properly grounded, and either :

- (1) If it is necessary to use an extension cord, use only a 3-wire extension cord that has a 3-blade grounding plug, and a 3-slot receptacle that will accept the plug on the appliance. The marked rating of the extension cord shall be equal to or greater than the electrical rating of the appliance. or
- (2) Do not use an extension cord, if the power supply cord is too short, have a qualified electrician or serviceman install an outlet near the appliance.
- (3) Do not cut or remove the third (ground) prong from the power cord under any circumstances.

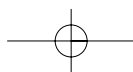

INSTALLATION

1. Examine the oven after unpacking.

Check for damage such as a misaligned door, broken door or dent in the cavity.
If any damage is visible, DO NOT INSTALL, and notify your dealer immediately.

2. Level, flat location.

Install the microwave oven on a level, flat surface.

3. Ventilation.

Do not block air vents. If they are blocked during operation, the oven may overheat and eventually cause a failure.

For proper ventilation, allow 3 inches of space between oven top, sides, rear and adjacent surfaces.

4. Away from radio and TV sets.

Poor television reception and radio interference may result if the oven is located close to a TV, radio, antenna, feeder, etc.

Place the oven as far from them as possible.

5. Away from heating appliances and water taps.

Keep the oven away from heat, steam or splashing liquids. These things can adversely affect oven wiring and contacts.

6. Power supply.

This microwave oven requires a power supply of approximately 20 Amperes, 120 Volts, 60Hz and a grounded outlet. A short power cord is provided to reduce the risk of the user becoming entangled in or tripping over a longer cord. Longer cord sets or extension cords are available and may be used if care is exercised in their use.

If an extension cord is used, the marked electrical rating of the cord should be at least as great as the electrical rating of the oven.

The extension cord must be a grounding-type 3-wire cord. The longer cord should be arranged so that it will not drape over the table top or counter where it can be pulled on by children or tripped over unintentionally.

7. The minimum height of free space necessary above the top surface of the oven is 100mm.

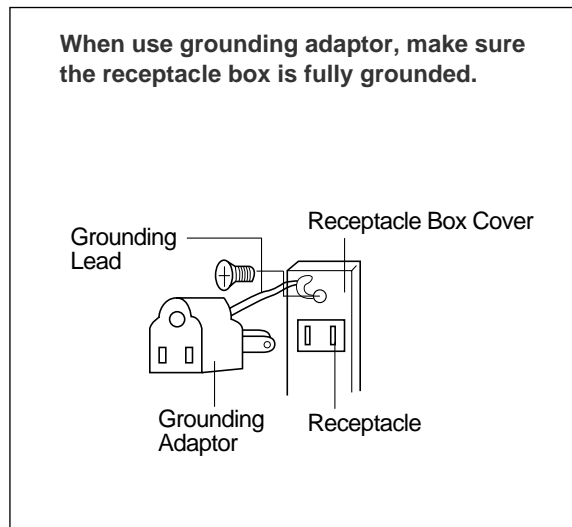
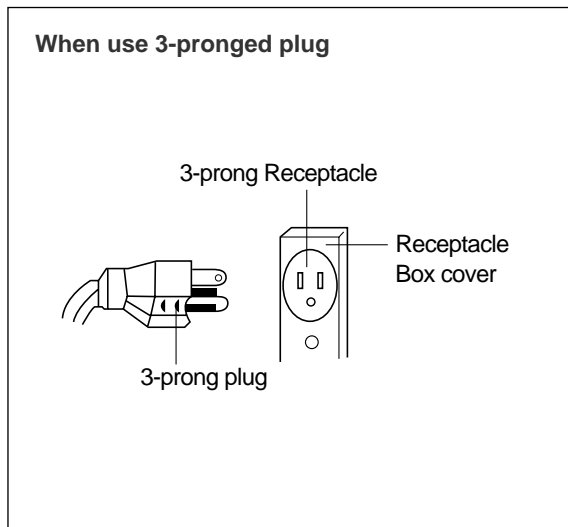

“THE CANADIAN ELECTRICAL CODE DOES NOT ALLOW THE USE OF THE GROUNDING ADAPTOR”

FEATURES DIAGRAM

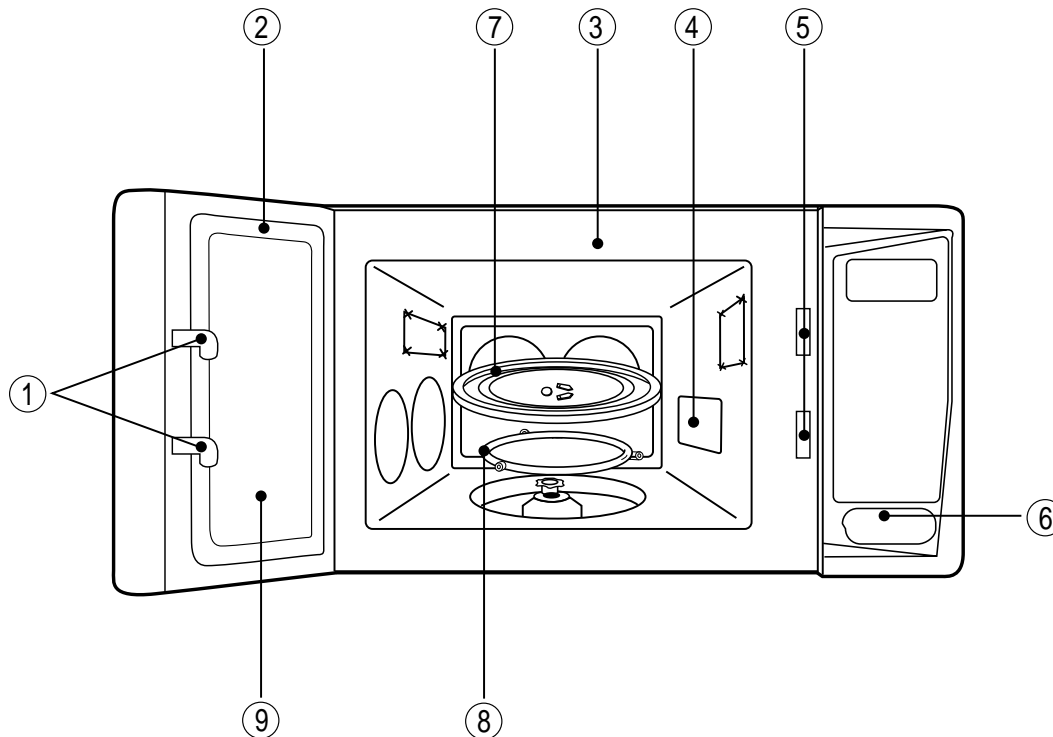

1. Door latch-When the door is closed it will automatically shut off. If the door is opened while the oven is operating, the magnetron will automatically shut off.

2. Door seal-The door seal maintains the microwave within the oven cavity and prevents microwave leakage.

3. Oven cavity

4. Spatter shield-Protects the microwave outlet from splashes of cooking foods.

5. Safety interlock system-Prevents the oven from operating while the door is opened. The oven will only operate with the door fully closed. When the door is open, the oven turns off and will only start again after the door is closed.

6. Door release button-Pushing this button stops oven operation and opens the door.

7. Glass cooking tray-Made of special heat resistant glass. The tray must always be in proper position before operating. Do not cook food directly on the tray.

8. Roller guide-Supports the glass cooking tray.

9. Door screen-Allows viewing of food. The screen is designed so that light can pass through, but not the microwaves.

FEATURES DIAGRAM (continued)

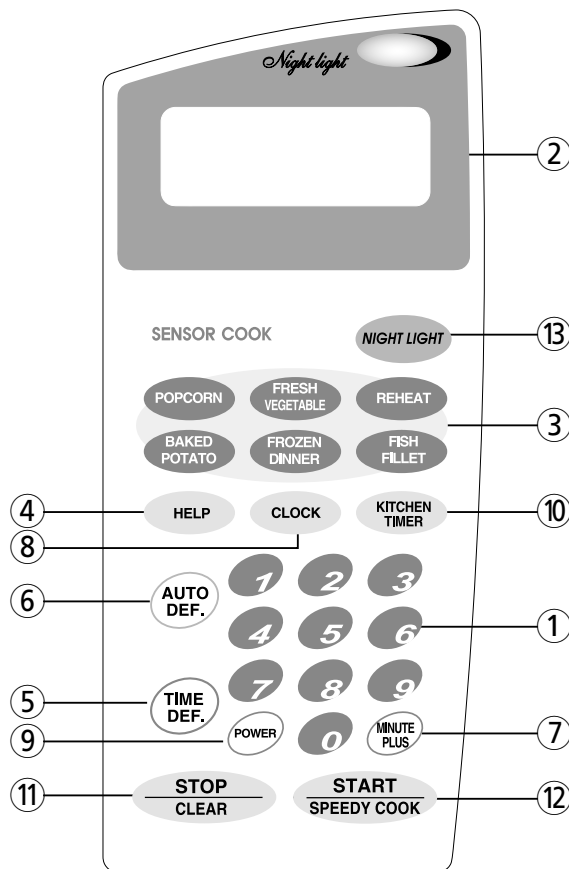

- ① **Time set pad** - Used to set the cooking time and the present time.
- ② **Display** - Cooking time, power level, indicators and present time are displayed.
- ③ **Sensor cook** - Used to automatically compute the microwave power and cooking time for foods.
- ④ **Help** - Used to help you to operate the oven easily.
- ⑤ **Time DEF.** - Used to defrost food. (for time)
- ⑥ **Auto DEF.** - Used to defrost food.(for weight)
- ⑦ **Minute plus** - Used to cook at 100% or to increase the cooking time by simply touching the pad.
- ⑧ **Clock** - Used to set clock.
- ⑨ **Power** - Used to set power level/Used to increase (or decrease) the cooking time for Sensor cooking.
- ⑩ **Kitchen timer** - Used as a minute timer, to delay the start of cooking, or to set a holding time after cooking.
- ⑪ **Stop/Clear** - Used to stop the oven operation or to erase all entries.
- ⑫ **Start /Speedy cook** - Used to start the oven operation/used to increase the reheat time by 30 seconds.
- ⑬ **Night Light** - Used to turn ON/OFF the Night Light.

OPERATION PROCEDURE

This section includes useful information about oven operation.

1. Plug power supply cord into a standard 3 - pronged 20 Amp, 120V AC 60Hz power outlet.
2. After placing the food in a suitable container, open the oven door and put it on the glass tray.
The glass tray and roller guide must always be in place during cooking.
3. Shut the door. Make sure that it is firmly closed.

- 1** The oven light is on only when the micro-wave oven is operating.
- 2** The oven door can be opened at any time during operation by pushing the door release button on the control panel. The oven will automatically shut off.
- 3** Each time a pad is touched, a BEEP will sound to acknowledge the touch.
- 4** The oven automatically cooks on full power unless set to a lower power level.
- 5** The display will show " HAVE A NICE COOKING TIME PRESS CLEAR " when the oven is plugged in.
- 6** Time clock returns to the present time when the cooking time ends.

- 7** When the STOP/CLEAR pad is touched during the oven operation, the oven stops cooking and all information retained.
To erase all information (except the present time), touch the STOP/CLEAR pad once more. If the oven door is opened during the oven operation, all information is retained.
- 8** If the START pad is touched and the oven does not operate, check the area between the door and door seal for obstructions and make sure the door is closed securely.
The oven will not start cooking until the door is completely closed or the program has been reset.

Make sure the oven is properly installed and plugged into the electrical outlet.

WATTAGE OUTPUT CHART

- The power - level is set by touching the POWER pad. The chart shows the display, the power level and the percentage of power.

Touch POWER pad	Power level (Display)	Approximate Percentage of Power
once	HIGH	100%
twice	PL-9	90%
3 times	PL-8	80%
4 times	PL-7	70%
5 times	PL-6	60%
6 times	PL-5	50%
7 times	PL-4	40%
8 times	PL-3	30%
9 times	PL-2	20%
10 times	PL-1	10%
11 times	PL-0	0%

CONTROLS

SENSOR COOK

Sensor is a semi-conductor device that detects the vapor (moisture and humidity) emitted from the food as it heats. The sensor adjusts the cooking time and power level for various foods and quantities and you don't need to enter the weight or quantity of the food. Follow the steps below for easy sensor cooking.

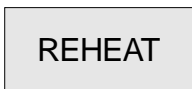

1. Touch REHEAT pad.
(This example shows "REHEAT" menu and other menus have the same procedures. Please refer to the SENSOR COOK CHART below.)

The SENSOR indicator appears and "REHEAT" is displayed. After 2 seconds, SENSOR indicator blinks and the oven starts cooking. When the sensor detects the vapor emitted from the food, remainder of cooking time appears with a beep and the display counts down the remaining time. When the cooking ends, the SENSOR indicator disappears and you will hear a beep.

SENSOR COOK CHART

Menu pad	Display		Amount	User Guide (When touching Help pad)	Procedure
	before operation	in operation			
Popcorn	"POPCORN"	"P-CORN"	1.5-3.5 OZ	"WEIGHT RANGE 1.5 TO 3.5 OZ"	Use only popcorn packaged for micro wave oven use. Try several brands to decide which you like the best. Do not try to pop unpopped kernels.
Fresh Vegetable	"FRESH VEGETABLE"	"FS-VEG"	0.25-1.5 LB	"COVER DISH WITH LID OR VENTED PLASTIC WRAP WEIGHT RANGE 0.25 TO 1.5 LB"	Place in casserole. Cover with lid for tender vegetables. Use plastic wrap cover for tender-crisp vegetables. After cooking, stir, if possible, let stand, covered, for 2 to 5 minutes.
Reheat	"REHEAT"	"REHEAT"	4-36 OZ	"COVER DISH WITH LID OR VENTED PLASTIC WRAP WEIGHT RANGE 4 TO 36 OZ"	Place in dish or casserole slightly larger than amount to be reheated. Flatten, if possible. Cover with lid, plastic wrap or wax paper. Use covers such as plastic wrap or lids with larger quantities of more dense foods such as stews. After reheating, stir well, if possible. Foods should be very hot. If not, continue to heat with variable power and time. After stirring, re-cover and allow to stand 2 to 3 minutes.
Baked Potato	"BAKED POTATO"	"POTATO"	2-5 POTATOES	"RANGE 2 TO 5 POTATO"	Pierce. Place on paper-towel-lined turntable. After cooking, remove from oven, wrap in aluminum foil and let stand 5 to 10 minutes.
Frozen Dinner	"FROZEN DINNER"	"DINNER"	7-12 OZ	"COVER DISH WITH LID OR VENTED PLASTIC WRAP WEIGHT RANGE 7 TO 12 OZ"	Use this pad for frozen convenience foods. It will give satisfactory results for most brands. You may wish to try several and choose your favorite. Remove package directions for covering. After cooking, let stand, covered, for 1 to 3 minutes.
Fish Fillet	"FISH FILLET"	"FILLET"	0.25-1.5 LB	"COVER DISH WITH LID OR VENTED PLASTIC WRAP WEIGHT RANGE 0.25 TO 1.5 LB"	Arrange in ring around shallow glass dish (roll fillet with edges underneath). Cover with plastic wrap. After cooking, let stand, covered for 3 minutes.

NOTE: 1. Any sensor cooking selection can be programmed with more or less time adjustment. In case of cooking more food than the quantity listed in the chart, touch the POWER pad once after touching one of sensor cook menus and before the oven beginning to start. In case of cooking less food, touch POWER pad twice.
 2. If you touch POWER pad during operation, the display shows the present power level and then returns to the chosen menu.
 3. Each menu has a cooking hint. Touch Help pad before the oven starts operating and the display will show the above mentioned user guides.
 4. If "SENSOR PREHEAT ERROR1 PRESS CLEAR" is displayed with a beep sound while you choose the sensor menu pad, turn off & on the oven and then try to use the oven again after 2 minutes. If there is still this error, contact the qualified service man.
 5. If "SENSOR PRESET ERROR3 PRESS CLEAR" is displayed with a beep sound during operation, turn off & on the oven and then try to use the oven again after 2 minutes.

AUTO DEFROST

AUTO DEFROST lets you easily defrost food by eliminating guess work in determining defrosting time. Follow the steps below for easy defrosting.

- | | | |
|-----------|---|--|
| AUTO DEF. | 1. Touch AUTO DEF. pad. | The DEFROST indicator appears and "AUTO DEFROST 1-GROUND MEAT 2-ROAST 3-POULTRY 4-FISH SELECT NUMBER" is displayed in sequence. "NUMBER" blinks three times. |
| | 2. Touch number pad for the food you want to defrost. | The displays are as follows and "LB" blinks three times. |

* AUTO DEFROST CHART

Auto Defrost menu	Display	User Guide (When touching Help pad)
1. GROUND MEAT	"GROUND MEAT -- ENTER WEIGHT IN LB"	"WEIGHT RANGE 0.5 TO 3.0 LB"
2. ROAST	"ROAST -- ENTER WEIGHT IN LB"	"WEIGHT RANGE 2.0 TO 3.5 LB"
3. POULTRY	"POULTRY -- ENTER WEIGHT IN LB"	"WEIGHT RANGE 1.0 TO 3.0 LB"
4. FISH	"FISH -- ENTER WEIGHT IN LB"	"WEIGHT RANGE 0.5 TO 1.5 LB"

- | | |
|---|---|
| 3. Touch number pads for weight within the proper range. (Please refer to the above "User Guide") | The selected weight appears and "PRESS START" is displayed. "START" blinks three times. |
|---|---|
- NOTE:** If you enter an incorrect weight out of range, "RANGE ERROR PRESS CLEAR" is displayed with a beep sound.

- | | |
|---------------------|--|
| 4. Touch Start pad. | The chosen menu is displayed and the DEFROST indicator starts blinking to show the oven is in the defrost mode. Then the display is changed into cooking time and counts down the remaining time. When the defrosting time ends, you will hear a beep. |
|---------------------|--|

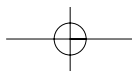

TIME DEFROST

When TIME DEFROST is selected, the automatic cycle divides the defrosting time into periods of alternating defrost and stand times by cycling on and off.

TIME
DEF.

1. Touch TIME DEF. pad.

The DEFROST indicator appears and "TIME DEFROST--ENTER DEFROST TIME" is displayed. "TIME" blinks three times.

2. Touch number pads for the desired defrosting time.

The selected time appears and "PRESS START" is displayed. "START" blinks three times.

NOTE: Your oven can be programmed for 59 minutes 99 seconds. (59:99)
If you try to set an incorrect time over 59 minutes 99 seconds, "RANGE ERROR PRESS CLEAR" is displayed with a beep sound.

3. Touch Start pad.

"TIME DEFROST" is displayed and the DEFROST indicator starts blinking to show the oven is in the defrost mode. Then the display is changed into cooking time and counts down the remaining time. When the defrosting time ends, you will hear a beep.

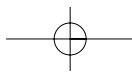

TIME COOK

POWER

1. Touch POWER pad.
program the desired power level. (Please refer to the wattage output chart in the page 7.)

“SELECT POWER LEVEL OR COOKING TIME
DEFAULT POWER LEVEL HIGH” is displayed.
“HIGH” blinks three times.

2. Touch number pads for the cooking time.

The selected time appears and “PRESS
START” is displayed. “START” blinks three times.

NOTE: Your oven can be programmed for 59 minutes 99 seconds. (59:99)
If you try to set an incorrect time over 59 minutes 99 seconds, “RANGE ERROR PRESS CLEAR” is displayed with a beep sound.

3. Touch Start pad.

The display is changed into cooking time and counts down the remaining time. When the cooking time ends, you will hear a beep.

NOTE: 1. Using lower power level increases the cooking time which is recommended for foods such as cheese, milk and slow cooking of meats.
2. Repeat the above procedures twice for time cook in two stages.
3. If the power pad is touched during operation, the present power level will appear in the display window.

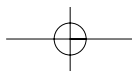

KITCHEN TIMER

HOW TO USE AS A MINUTE TIMER

KITCHEN TIMER

1. Touch KITCHEN TIMER pad. The TIMER indicator appears and "ENTER TIME" is displayed. "TIME" blinks three times.
2. Touch number pads for the time you want to count down. The selected time appears and "PRESS START" is displayed. "START" blinks three times.
3. Touch Start pad. The TIMER indicator starts blinking. The display is changed into the time in kitchen timer mode and counts down the remaining time. When kitchen timer mode ends, you will hear a beep.

HOW TO USE TO DELAY THE START OF COOKING

KITCHEN TIMER

1. Touch KITCHEN TIMER pad. The TIMER indicator appears and "ENTER TIME" is displayed. "TIME" blinks three times.
2. Touch number pads for the time you want to delay. The selected time appears and "PRESS START" is displayed. "START" blinks three times.
3. Touch POWER pad and program the desired power level. "SELECT POWER LEVEL OR COOKING TIME DEFAULT POWER LEVEL HIGH" is displayed. "HIGH" blinks three times.
4. Touch number pads for the time to be cooked. The selected time appears and "PRESS START" is displayed. "START" blinks three times.
5. Touch Start pad. The Timer indicator starts blinking. The display is changed into the time in kitchen timer mode and counts down the remaining time. When kitchen timer mode ends, the display counts down the time in cooking mode. When the cooking mode ends, you will hear a beep.

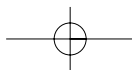

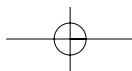

KITCHEN TIMER (continued)

HOW TO USE TO SET A HOLDING TIME

KITCHEN TIMER

1. Program the desired defrost or time cook.
2. Touch KITCHEN TIMER pad. The TIMER indicator appears and "ENTER STANDING TIME" is displayed. "TIME" blinks three times.
3. Touch number pads for the time you want to hold. The selected time appears and "PRESS START" is displayed. "START" blinks three times.
4. Touch Start pad. The oven is in the defrosting or time cooking mode and the display is changed into the time in respective mode. (In defrost mode, DEFROST indicator blinks.) When the defrost or time cook mode ends, TIMER indicator starts blinking and the display counts down the remaining time in kitchen timer mode. When the mode ends, you will hear a beep.

NOTE: 1. Your oven can be programmed for 59 minutes 99 seconds. (59:99) If you try to set an incorrect time over 59 minutes 99 seconds, "RANGE ERROR PRESS CLEAR" is displayed with a beep sound.
 2. The KITCHEN TIMER function has no relation to the clock setting.
 3. If the power pad is touched during operation, the present power level will appear in the display window.

SPEEDY COOK

SPEEDY COOK allows you to cook at 100% (full power) by simply touching SPEEDY COOK pad. By repeatedly touching SPEEDY COOK pad, you can also extend the cooking time to 5 minutes by 30 seconds.

START/ SPEEDY COOK

1. Touch SPEEDY COOK pad. If you touch SPEEDY COOK pad once, ":30" appears and the oven starts cooking. The display counts down the cooking time. When the time ends, you will hear a beep.

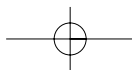

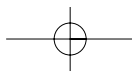

MINUTE PLUS

MINUTE PLUS allows you to cook at 100% or to increase the cooking time during time cooking by simply touching the Minute Plus pad. Each time Minute Plus pad is touched, the cooking time is extended by 1 minute to a maximum of 59 minutes.

MINUTE PLUS

1. Touch MINUTE PLUS pad.

If you touch MINUTE PLUS pad once, "1:00" appears and the oven starts cooking. The display counts down the cooking time. When the time ends, you will hear a beep.

CLOCK

CLOCK

1. Touch CLOCK pad.

This is a 12 hour clock system. "12 HOUR MODE--ENTER TIME" is displayed and "TIME" blinks three times.

NOTE: This oven has multiple clock system. If you want 24 hour clock system, use help function and set 24 hour clock system before this step.

2. Enter the correct time of day by touching the time set pads.

The selected time appears and "PRESS CLOCK" is displayed. "CLOCK" blinks three times.

3. Touch CLOCK pad.

The colon starts blinking and the display shows the present time.

NOTE: 1. If you selected 12 hour clock system, this digital clock allows you to set from 1:00 to 12:59. If you selected 24 hour clock system, this digital clock allows you to set from 0:00 to 23:59.
2. If you attempt to enter an incorrect time, the time will not be set and an error signal tone will sound. Touch CLOCK pad and re-enter the correct time.

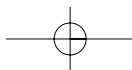

HELP

HELP provides 6 features which enable you to use the oven easily.

- CHILD LOCK** This function prevents unwanted oven operation such as by small children.
- LB, G** This allows you to choose the weight unit between LB and G.
- BEEP** If "OFF" mode is set, you can operate the oven with no audible signal.
- CLOCK MODE** This allows you to choose the clock mode between 12 and 24 hour clock system.
- ENERGY SAVE** If "ON" mode is set, the display turns off except during operation.
- 3 LANGUAGE** This oven can be set for three languages - ENGLISH, FRENCH, SPANISH.

HELP	1. Touch HELP pad.	The HELP indicator appears and "HELP FUNCTION 1-CHILD LOCK 2-LB, G 3-BEEP 4-CLOCK MODE 5-ENERGY SAVE 6-3 LANGUAGE SELECT NUMBER" is displayed in sequence. "NUMBER" blinks three times.
	2. Touch number pad for the necessary function. (Please refer to the HELP FUNCTION CHART below.)	The display shows the chosen mode and returns to the present time.

*** HELP FUNCTION CHART**

Help Function	Display	Default
1. CHILD LOCK	"CHILD LOCK 1-ON 2-OFF SELECT NUMBER"	OFF
2. LB, G	"WEIGHT UNIT 1-LB 2-G SELECT NUMBER"	LB
3. BEEP	"BEEP 1-ON 2-OFF SELECT NUMBER"	ON
4. CLOCK MODE	"CLOCK MODE 1-12 HR 2-24 HR SELECT NUMBER"	12 HOUR
5. ENERGY SAVE	"ENERGY SAVE 1-ON 2-OFF SELECT NUMBER"	OFF
6. 3 LANGUAGE	"3 LANGUAGE 1-ENGLISH 2-FRENCH 3-SPANISH SELECT NUMBER"	ENGLISH

- 3. Enter the number for the desired mode. The displays are as shown in the chart below and "NUMBER" blinks three times.

NOTE: If you touch Help pad after choosing Sensor Cook, the display will show the user guides of respective foods. If you want to select the above help functions, first of all, touch Help pad and choose the desired mode.

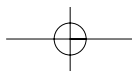

NIGHT LIGHT

NIGHT LIGHT

1. Touch NIGHT LIGHT pad.

If you touch NIGHT LIGHT pad ones, the night light turns ON.

2. Touch NIGHT LIGHT pad again.

If you touch NIGHT LIGHT pad again, the night light turns OFF.

NOTE: 1. Night light will be automatically off during cooking operation. (except kitchen timer).
2. If you turn on the night light after the clock setting, night light will be automatically off after 10 hour.

TO STOP THE OVEN WHILE THE OVEN IS OPERATING

1. Touch STOP/CLEAR pad.

- You can restart the oven by touching START pad.
- Touch STOP/CLEAR pad once more to erase all instructions.
- You must enter in new instructions.

2. Open the door.

- You can restart the oven by closing the door and touching START pad.

NOTE: Oven stops operating when door is opened.

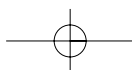

CARE OF YOUR MICROWAVE OVEN

- 1 Turn the oven off before cleaning.
- 2 Keep the inside of the oven clean. When food spatters or spilled liquids adhere to oven walls, wipe with a damp cloth. Mild detergent may be used if the oven gets very dirty. The use of harsh detergent or abrasives is not recommended.
- 3 The outside oven surface should be cleaned with soap and water, rinsed and dried with a soft cloth. To prevent damage to the operating parts inside the oven, water should not be allowed to seep into the ventilation openings.
- 4 If the Control Panel becomes wet, clean with a soft, dry cloth. Do not use harsh detergents or abrasives on Control Panel.
- 5 If steam accumulates inside or around the outside of the oven door, wipe with a soft cloth. This may occur when the microwave oven is operated under high humidity conditions and in no way indicates malfunction of the unit.
- 6 It is occasionally necessary to remove the glass tray for cleaning. Wash the tray in warm sudsy water or in a dishwasher.
- 7 The roller guide and oven cavity floor should be cleaned regularly to avoid excessive noise. Simply wipe the bottom surface of the oven with mild detergent water or window cleaner and dry. The roller guide may be washed in mild sudsy water.

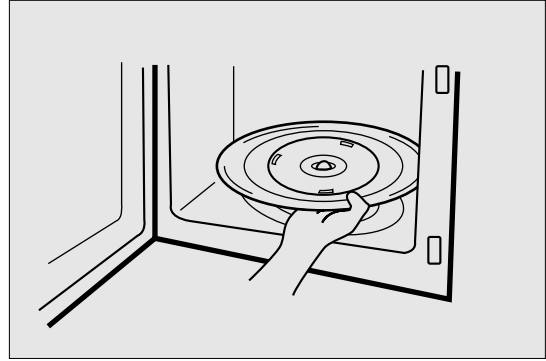

ROLLER GUIDE

- 1 The ROLLER GUIDE and oven floor should be cleaned frequently to prevent excessive noise.
- 2 The ROLLER GUIDE MUST ALWAYS be used for cooking together with the Glass Tray.

GLASS TRAY

- 1 DO NOT operate the oven without the Glass Tray in place.
- 2 DO NOT use any other Glass Tray with this oven.
- 3 If Glass Tray is hot, ALLOW TO COOL before cleaning or placing it in water.
- 4 DO NOT cook directly on the Glass Tray. (Except for popcorn)

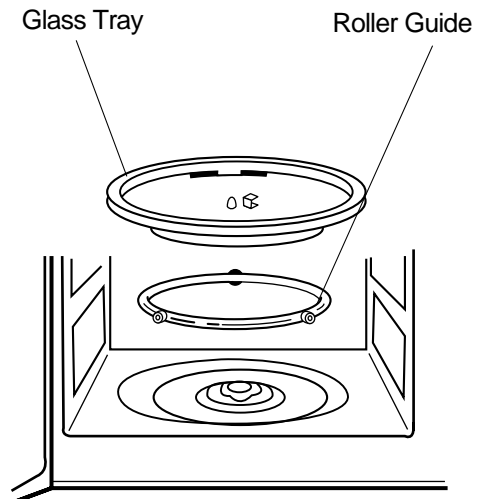

QUESTIONS AND ANSWERS

*** Q : I accidentally ran my microwave oven without any food in it. Is it damaged?**

A : Running the oven empty for a short time will not damage the oven. However, it is not recommended.

*** Q : Can the oven be used with the glass tray or roller guide removed?**

A : No. Both the glass tray and roller guide must always be used in the oven before cooking.

*** Q : Can I open the door when the oven is operating?**

A : The door can be opened anytime during the cooking operation. Then microwave energy will be instantly switched off and the time setting will maintain until the door is closed.

*** Q : Why do I have moisture in my microwave oven after cooking?**

A : The moisture on the side of your microwave oven is normal. It is caused by steam from cooking food hitting the cool oven surface.

*** Q : Does microwave energy pass through the viewing screen in the door?**

A : No. The metal screen bounces back the energy to the oven cavity. The holes are made to allow light to pass through. They do not let microwave energy pass through.

*** Q : Why do eggs sometimes pop?**

A : When baking or poaching eggs, the yolk may pop due to steam build-up inside the yolk membrane. To prevent this, simply pierce the yolk with a toothpick before cooking. Never cook eggs without piercing their shells.

*** Q : Why this standing time recommended after the cooking operation has been completed?**

A : Standing time is very important. With microwave cooking, the heat is in the food, not in the oven. Many foods build up enough internal heat to allow the cooking process to continue, even after the food is removed from the oven. Standing time for joints of meat, large vegetables and cakes is to allow the inside to cook completely, without overcooking the outside.

*** Q : What does "standing time" mean?**

A : "Standing time" means that food should be removed from the oven and covered for additional time to allow it to finish cooking. This frees the oven for other cooking.

*** Q : Why does my oven not always cook as fast as the microwave cooking guide says?**

A : Check your cooking guide again, to make sure you've followed directions exactly ; and to see what might cause variations in cooking time. Cooking guide times and heat settings are suggestions, to help prevent over-cooking... the most common problem in getting used to a microwave oven. Variations in the size, shape and weights and dimensions could require longer cooking time. Use your own judgement along with the cooking guide suggestions to check whether the food has been properly cooked just as you would do with a conventional cooker.

*** Q : Will the microwave oven be damaged if it operates while empty?**

A : Yes. Never run it empty.

*** Q : Can I operate my microwave oven without the turntable or turn the turntable over to hold a large dish?**

A : No. If you remove or turn over the turntable, you will get poor cooking results. Dishes used in your oven must fit on the turntable.

*** Q : Is it normal for the turntable to turn in either direction?**

A : Yes. The turntable rotates clockwise or counterclockwise, depending on the rotation of the motor when the cooking cycle begins.

*** Q : Can I pop popcorn in my microwave oven? How do I get the best results?**

A : Yes. Pop packaged microwave popcorn following manufacture's guidelines. Do not use regular paper bags. Use the "listening test" by stopping the oven as soon as the popping slows to a "pop" every 1 or 2 seconds. Do not repop unpopped kernels. Do not pop popcorn in glass cookware.

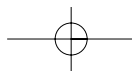

BEFORE YOU CALL FOR SERVICE

Refer to following checklist, you may prevent an unnecessary service call.

*** The oven doesn't work :**

1. Check that the power cord is securely plugged in.
2. Check that the door is firmly closed.
3. Check that the cooking time is set.
4. Check for a blown circuit fuse or tripped main circuit breaker in your house.

*** Sparking in the cavity;**

1. Check utensils. Metal containers or dishes with metal trim should not be used.
2. Check that metal skewers or foil does not touch the interior walls.

If there is still a problem, contact the service station.
A list of these stations is included in the oven.

DO NOT ATTEMPT TO SERVICE THE OVEN YOURSELF !

CARE AND CLEANING

Although your oven is provided with safety features, it is important to observe the following:

1. It is important not to defeat or tamper with safety interlocks.
 - i) Door(bent)
 - ii) Hinges and Hookes(broken or loosened)
 - iii) Door seals and sealing surfaces.
2. Do not place any object between the oven front face and the door or allow residue to accumulate on sealing surfaces. Wipe the sealing area frequently with a mild detergent, rinse and dry. Never use abrasive powders or pads.
3. When opened, the door must not be subjected to strain, for example, a child hanging on an opened door or any load could cause the oven to fall forward to cause injury and also damage to the door. Do not operate the oven if it is damaged, until it has been repaired by a competent service technician. It is particularly important that the oven closes properly and that there is no damage to the:
 4. The oven should not be adjusted or repaired by anyone except a properly competent service technician.
 5. The oven should be cleaned regularly and any food deposits removed;
 6. Failure to maintain the oven in a clean condition could lead to deterioration of the surface that could adversely affect the life of the appliance and possibly result in a hazardous situation.

SPECIFICATIONS

POWER SUPPLY	120V 60Hz 20A, SINGLE PHASE WITH EARTHING
MICROWAVE POWER CONSUMPTION	1400 W
MICROWAVE ENERGY OUTPUT	950 W, FULL MICROWAVE POWER
MICROWAVE FREQUENCY	2450MHz
OUTSIDE DIMENSIONS (W X H X D)	465 x 279 x 368mm (18.3 x 11.0 x 14.5 in)
CAVITY DIMENSIONS (W X H X D)	290 x 211 x 306mm (11.4 x 8.3 x 12.0 in)
NET WEIGHT	APPROX. 12Kg (26.5 lbs)
TIMER	59 min. 99 sec.
POWER SELECTIONS	10 LEVELS

* Specifications are subject to change without notice.

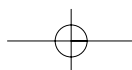

COOKING INSTRUCTIONS

Utensil Guide

Only use utensils that are suitable for use in microwave ovens.

To cook food in the microwave oven, the microwaves must be able to penetrate the food, without being reflected or absorbed by the dish used. Care must therefore be taken choosing the utensil. If the utensil is marked microwave-safe, you do not need to worry. The following table lists various of utensil and indicates whether and how they should be used in a microwave oven.

Utensil	Safe	Comments
Aluminium foil	▲	Can be used in small quantities to protect areas against overcooking. Arcing can occur if the foil is too close to the oven wall or if too much foil is used.
Crust plate	●	Do not preheat for more than 8minutes.
China and earthenware	●	Porcelain, pottery, glazed earthenware and bone china are usually suitable, unless deco-rated with a metal trim.
Disposable polyester cardboard dishes	●	Some frozen foods are packaged in these dishes.
Fast-food packaging • Polystyrene cups containers • Paper bags or newspaper • Recycled paper or metal trims	● × ×	Can be used to warm food. Overheating may cause the polystyrene to melt. May catch fire. May cause arcing.
Glassware • Oven-to-table ware • Fine glassware • Glass jars	● ● ●	Can be used, unless decorated with a metal trim. Can be used to warm foods or liquids. Delicate glass may break or crack if heated suddenly. Must remove the lid. Suitable for warming only.
Metal • Dishes • Freezer bag twist ties	× ×	May cause arcing or fire.
Paper • Plates, cups, napkins and Kitchen paper • Recycled paper	● ×	For short cooking times and warming. Also to absorb excess moisture. May cause arcing.
Plastic • Containers • Cling film • Freezer bags	● ● ▲	Particularly if heat-resistant thermoplastic. Some other plastics may warp or discolour at high temperatures. Do not use Melamine plastic. Can be used to retain moisture. Should not touch the food. Take care when removing the film as hot steam will escape. Only if boilable or oven-proof. Should not be airtight. Prick with a fork, if necessary.
Wax or grease-proof paper	●	Can be used to retain moisture and prevent spattering.

● : Recommended use

▲ : Limited Use

× : Not Recommended

USE YOUR MICROWAVE OVEN SAFELY

General Use

Do not attempt to defeat or tamper with safety interlocks.

Do not place any object between the oven front frame and the door or allow residue to build up on sealing surfaces. Wipe with a mild detergent, rinse and dry.

Never use abrasive powders or pads.

Do not subject the oven door to strain or weight such as a child hanging on an open door.

This could cause the oven to fall forward resulting in injury to you and damage to the oven.

Do not operate the oven if door seals or sealing surfaces are damaged; or if door is bent; or if hinges are loose or broken.

Do not operate the oven empty. This will damage the oven.

Do not attempt to dry clothes, newspapers or other materials in the oven. They may catch on fire.

Do not use recycled paper products as they may contain impurities which may cause sparks or fires.

Do not hit or strike the control panel with hard objects. This can damage the oven.

Food

Never use your microwave oven for home canning. The oven is not designed for proper home canning. Improperly canned food may spoil and be dangerous to consume.

Always use the minimum recipe cooking time. It is better to undercook rather than overcook foods.

Undercooked foods can be returned to the oven for more cooking. If food is overcooked, nothing can be done.

Heat small quantities of food or foods with low moisture carefully. These can quickly dry out, burn or catch on fire.

Do not heat eggs in the shell. Pressure may build up and eggs can explode.

Potatoes, apples, egg yolks and sausages are examples of food with non-porous skins.

These must be pierced before cooking to prevent bursting.

Do not attempt to deep fat fry in your microwave oven.

Always allow a standing time of at least 20 seconds after the oven has been switched off to allow the

temperature to even out, stir during heating, if necessary, and ALWAYS stir after heating. To prevent eruptive boiling and possible scalding, you should put a spoon or glass stick into the beverages and stir before, during and after heating.

Do not leave the oven unattended while popping corn.

Do not pop corn in a paper bag unless it is the commercially prepared Microwave Popcorn product. The kernels can overheat and ignite a brown paper bag.

Do not put packaged Microwave Popcorn bags directly on the oven tray. Place the package on a microwave safe glass or ceramic plate to avoid overheating and cracking the oven tray.

Do not exceed the Microwave Popcorn manufacturers suggested popping time.

Longer popping does not yield more popcorn but it can result in scorch, burn or fire. Remember, the Popcorn bag and tray can be too hot to handle.

Remove with caution and use pot holders.

ARCING

If you see arcing, touch STOP/CLEAR pad and correct the problem.

Arcing is the microwave term for sparks in the oven.

Arcing is caused by:

- Metal or foil touching the side of the oven.
- Foil not molded to food (upturned edges act like antennas).

- Metal, such as twist-ties, poultry pins, or gold rimmed dishes, in the microwave.

- Recycled paper towels containing small metal pieces being used in the microwave.

MICROWAVING PRINCIPLES

Microwave energy has been used in this country to cook and reheat food since early experiments with RADAR in World War II. Microwaves are present in the atmosphere all the time, both naturally and manmade sources. Manmade sources include radar, radio, television, telecommunication links and car phones.

HOW MICROWAVES COOK FOOD

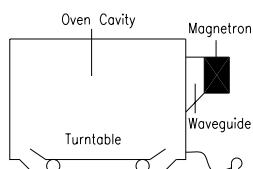

In a microwave oven, electricity is converted into microwave by the **MAGNETRON**.

► TRANSMISSION

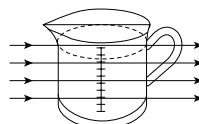

Then they pass through the cooking containers to be absorbed by the water molecules in the food, all foods contain water to a more or lesser extent.

► REFLECTION

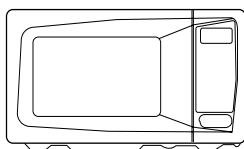

The microwaves bounce off the metal walls and the metal door screen.

► ABSORPTION

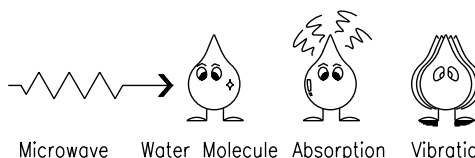

The microwaves cause the water molecules to vibrate which causes **FRICTION**, i.e. **HEAT**. This heat then cooks the food. Microwaves are also attracted to fat and sugar particles, and foods high in these will cook more quickly. Microwaves can only penetrate to a depth of 1 1/2 - 2 inches (4-5cm) and as heat spreads through the food by conduction, just as in a traditional oven, the food cooks from the outside inwards.

CONVERSION CHARTS

WEIGHT MEASURES		VOLUME MEASURES		SPOON MEASURES	
15 g	1/2 oz.	30 ml	1 fl.oz.	1.25 ml	1/4 tsp
25 g	1 oz.	100 ml	3 fl.oz.	2.5 ml	1/2 tsp
50 g	2 oz.	150 ml	5 fl.oz. (1/4 pt)	5 ml	1 tsp
100 g	4 oz.	300 ml	10 fl.oz. (1/2 pt)	15 ml	1 tbsp
175 g	6 oz.	600 ml	20 fl.oz. (1pt)		
225 g	8 oz.				
450 g	1 lb.				

FLUID MEASUREMENTS		
1 Cup	= 8 fl.oz.	= 240 ml
1 Pint	= 16 fl.oz. (UK 20 fl.oz.)	= 480 ml (UK 560 ml)
1 Quart	= 32 fl.oz. (UK 40 fl.oz.)	= 960 ml (UK 1120 ml)
1 Gallon	= 128 fl.oz. (UK 160 fl.oz.)	= 3840 ml (UK 4500 ml)

COOKING TECHNIQUES

STANDING TIME

Dense foods e.g. meat, jacket potatoes and cakes, require standing time (inside or outside of the oven) after cooking, to allow heat to finish conducting to cook the center completely. Wrap meat joints and jacket potatoes in aluminium foil while standing. Meat joints need approx. 10-15 minutes, jacket potatoes 5 minutes. Other foods such as plated meal, vegetables, fish etc require 2-5 minutes standing. After defrosting food, standing time should also be allowed. If food is not cooked after standing time, return to the oven and cook for additional time.

MOISTURE CONTENT

Many fresh foods e.g. vegetables and fruit, vary in their moisture content throughout the season, particularly jacket potatoes. For this reason cooking times may have to be adjusted. Dry ingredients e.g. rice, pasta, can dry out during storage so cooking times may differ.

DENSITY

Porous airy foods heat more quickly than dense heavy foods.

CLING FILM

Cling film helps keep the food moist and the trapped steam assists in speeding up cooking times. Pierce before cooking to allow excess steam to escape. Always take care when removing cling film from a dish as the build-up of steam will be very hot.

SHAPE

Even shapes cook evenly. Food cooks better by microwave when in a round container rather than square.

SPACING

Foods cook more quickly and evenly if spaced apart. NEVER pile foods on top of each other.

STARTING TEMPERATURE

The colder the food, the longer it takes to heat up. Food from a fridge takes longer to reheat than food at room temperature.

LIQUIDS

All liquids must be stirred before and during heating. Water especially must be stirred before and during heating, to avoid eruption. Do not heat liquids that have previously been boiled. DO NOT OVERHEAT.

TURNING & STIRRING

Some foods require stirring during cooking. Meat and poultry should be turned after half the cooking time.

ARRANGING

Individual foods e.g. chicken portions or chops, should be placed on a dish so that the thicker parts are towards the outside.

QUANTITY

Small quantities cook faster than large quantities, also small meals will reheat more quickly than large portions.

PIERCING

The skin or membrane on some foods will cause steam to build up during cooking. These foods must be pierced or a strip of skin should be peeled off before cooking to allow the steam to escape. Eggs, potatoes, apples, sausages etc, will all need to be pierced before cooking. DO NOT ATTEMPT TO BOIL EGGS IN THEIR SHELLS.

COVERING

Cover foods with microwave cling film or a lid. Cover fish, vegetables, casseroles, soups. Do not cover cakes, sauces, jacket potatoes or pastry items.

DEFROSTING GUIDE

Do not defrost covered meat. Covering might allow cooking to take place. Always remove outer wrap and tray. Use only containers that are microwave-safe.

Begin defrosting whole poultry breast-side-down.

Begin defrosting roasts fat-side-down.

The shape of the package alters the defrosting time.

Shallow rectangular shapes defrost more quickly than a deep block.

After 1/3 of the defrost time has elapsed, check the food. You may wish to turn over, break apart, rearrange or remove thawed portions of the food.

During defrost, the oven will prompt you to turn the over. At this point, open oven door and check the food. Follow the techniques listed below for optimum defrost results.

Then, close oven door, touch the START pad to complete defrosting.

When defrosted, food should be cool, but softened in all areas. If still slightly icy, return to microwave oven very briefly, or let stand a few minutes. After defrosting, allow food to stand 5-60 minutes if there are any icy areas.

Poultry and fish may be placed under running cool water until defrosted

⇒ **Turn over** : Roast, ribs, whole poultry, turkey breasts, hot dogs, sausages, steaks, or chops.

⇒ **Rearrange** : Break apart or separate steaks, chops, hamburger patties, ground meat, chicken or seafood pieces, chunks of meat such as stew beef.

⇒ **Shield** : Use small strips of aluminum foil to protect thin areas or edges of unevenly shaped foods such as chicken wings. To prevent arching, do not allow foil to come within 1-inch of oven walls or door.

⇒ **Remove** : To prevent cooking, thawed portions should be removed from the oven at this point. This may shorten defrost time for food weighing less than 3 lbs.(1350g).

DEFROSTING CHART(by Time Defort)

Item & Weight	Defrosting Time	Standing Time	Special Techniques
BEEF			
Minced beef 1 lb./450g	6-8 min.	15-20 min.	Break apart and remove thawed portions with fork.
Stew Meat 1 1/2 lbs./675g	11-13 min.	25-30 min.	Separate and rearrange once.
Patties 4(4oz./110g)	6-8 min.	15-20 min.	Turn over after half the time.
PORK			
Spareribs 1 lb./450g	7-9 min.	25-30 min.	Separate and rearrange once.
Chops 4(5oz./125g)	6-8 min.	25-30 min.	Separate and turn over once.
Minced pork 1 lb./450g	6-8 min.	15-20 min.	Break apart and remove thawed portions with fork.
POULTRY			
Whole Chicken 2 1/2 lbs./1125g	18-22 min.	45-90 min.	Break side down. Turn over after half the time. Shield as needed.
Chicken Breasts 1 lbs./450g	6-8 min.	15-30 min.	Separate and rearrange once.
Fryer Chicken(cut up) 2 lbs./900g	16-18 min.	25-30 min.	Separate and rearrange once.
Chicken Thighs 1 1/2 lbs./675g	12-14 min.	15-30 min.	Separate and rearrange once.
FISH & SEAFOOD			
Whole Fish 1 lb./450g	6-8 min.	15-20 min.	Turn over after half the time. Shield as needed.
Fish Fillets 1 1/2 lb./675g	11-13 min.	15-20 min.	Separate and turn over once.
Shrimp 1/2 lb./225g	2-4 min.	15-20 min.	Separate and rearrange once.

* The times are approximate because freezer temperatures vary.

COOKING & REHEATING CHART

Cooking chart

Item	Power Level	Cooking Time Per lb./450g	Special Instruction
MEAT			
Beef joint-Rare	P-80	5-7 min.	<ul style="list-style-type: none"> - Chilled meat and poultry should be removed from the refrigerator at least 30 minutes before cooking. - Always let the meat and poultry stand, covered after cooking.
-Medium	P-80	6-8 min.	
-well done	P-80	7-9 min.	
Pork Joint	P-HI	8-10 min.	
Bacon joint	P-HI	6-8 min.	
POULTRY			
Whole chicken	P-HI	6-8 min.	
Portions chicken	P-80	5-7 min.	
Breast (boned)	P-80	5-7 min.	
FISH			
Fish Fillets	P-HI	3-5 min.	<ul style="list-style-type: none"> - Brush a little oil or melted butter over the fish, or add 15~30ml(1-2 tbsp) lemon juice, wine, stock, milk or water. - Always let the fish stand, covered, after cooking
Whole Mackerel, Cleaned and prepared	P-HI	3-5 min.	
Whole Trout, Cleaned & Prepared	P-HI	3-5 min.	
Salmon steaks	P-HI	3-5 min.	
<p>NOTE : The above times should be regarded only as a guide. Allow for difference in individual tastes and preferences. The times may vary due to the shape, cut, and composition of the food. Frozen meat, poultry and fish must be thoroughly thawed before cooking.</p>			

Reheating chart

- Baby food particularly needs to be checked carefully before serving to prevent burns.
- When heating pre-packaged ready-cooked foods, always follow the pack instructions carefully.
- If you freeze foods which were bought from the fresh or chilled counters, remember that they should be thoroughly thawed before following the heating instructions on the packed. It's worth putting a note on them so that other members of the household will remember too.
- Remember metal ties and transfer food from foil containers before reheating.
- Chilled(refrigerated) food takes longer to reheat than food at room temperature (such as just-cooled food or food from the store cupboard).
- All foods should be reheated using full microwave power.

Item	Cooking time	Special Instructions
Baby food 128g jar	20 sec.	Empty into a small serving bowl. Stir well once or twice during heating. Before serving, check the temperature carefully.
Baby milk 100ml / 4fl.oz. 225ml / 8fl.oz.	20-30 sec. 40-50 sec.	Stir or shake well and pour into a sterilized bottle. Before serving, shake well and check the temperature carefully.
Sandwich roll or bun 1 roll	20-30 sec.	Wrap in paper towel and place on glass microwaveable rack. *Note : Do not use recycled paper towels.
Lasagna 1 serving (10 1/2 oz./300g)	4-6 min.	Place lasagna on microwaveable plate. Cover with plastic wrap and vent.
Casserole 1 cup 4 cups	1 1/2-3 min. 5-7 min.	Cook covered in microwaveable casserole. Stir once halfway through cooking.
Mashed potatoes 1 cup 4 cups	2-3 min. 6-8 min.	Cook covered in microwaveable casserole. Stir once halfway through cooking.
Baked beans 1 cup	2-3 min.	Cook covered in microwaveable casserole. Stir once halfway through cooking.
Ravioli or pasta in sauce 1 cup 4 cups	3-4 min. 7-10 min.	Cook covered in microwaveable casserole. Stir once halfway through cooking.

VEGETABLE CHART

Use a suitable glass pyrex bowl with lid. Add 30-45ml cold water(2-3 tbsp.) for every 250g unless another water quantity is recommended - see table. Cook covered for the minimum time - see table. Continue cooking to get the result you prefer. Stir once during and once after cooking. Add salt, herbs or butter after cooking. Cover during a standing time of 3 minutes.

Hint : cut the fresh vegetables into even sized pieces. The smaller they are cut, the quicker they will cook.

All vegetables should be cooked using full microwave power.

Cooking Guide for fresh vegetables

Vegetables	Weight	Time	Comments
Broccoli	1/2 lb./250g 1 lb./500g	2-3 min 3-5 min	Prepare even sized florets. Arrange the stems to the centre.
Brussels sprouts	1/2 lb./250g	2-3 min	Add 60-75ml(5-6tbsp.) water.
Carrots	1/2 lb./250g	2-3 min	Cut carrots into even sized slices.
Cauliflower	1/2 lb./250g 1 lb./500g	2-3 min 3-5 min	Prepare even sized florets. Cut big florets into halves. Arrange stems to the centre.
Courgettes	1/2 lb./250g	2-3 min	Cut courgettes into slices. Add 30ml(2tbsp.) water or a knob of butter. Cook until just tender.
Egg plants	1/2 lb./250g	2-3 min	Cut egg plants into small slices and sprinkle with 1 tablespoon lemon juice.
Leeks	1/2 lb./250g	2-3 min	Cut leeks into thick slices.
Mushrooms	0.3 lb./125g 1/2 lb./250g	1-2 min 2-3 min	Prepare small whole or sliced mushrooms. Do not add any water. Sprinkle with lemon juice. Spice with salt and pepper. Drain before serving.
Onions	1/2 lb./250g	2-3 min	Cut onions into slices or halves. Add only 15ml(1tbsp.) water.
Pepper	1/2 lb./250g	2-4 min	Cut pepper into small slices.
Potatoes	1/2 lb./250g 1 lb./500g	2-3 min 6-8 min	Weigh the peeled potatoes and cut them into similar sized halves or quarters.
Turnip cabbage	1/2 lb./250g	4-6 min	Cut turnip cabbage into small cubes.

Cooking Guide for frozen vegetables

Vegetables	Weight	Time	Instructions
spinach	0.3 lb./125g	1-2 min	Add 15ml(1tbsp.) cold water.
broccoli	1/2 lb./250g	2-3 min	Add 30ml(2 tbsp.) cold water.
Peas	1/2 lb./250g	2-3 min	Add 15ml(1 tbsp.) cold water.
Green beans	1/2 lb./250g	3-4 min	Add 30ml(2tbsp.) cold water.
Mixed vegetables (carrots/peas/corn)	1/2 lb./250g	2-4 min	Add 15ml(1tbsp.) cold water.
Mixed vegetables (Chinese style)	1/2 lb./250g	3-5 min	Add 15ml(1 tbsp.) cold water.

RECIPES

TOMATO & ORANGE SOUP

1 oz.(25g) butter
 1 medium onion, chopped
 1 large carrot & 1 large potato, chopped
 1³/₄lb(800g) canned, chopped tomatoes
 juice and grated rind of 1 small orange
 1¹/₂pints(900ml) hot vegetable stock
 salt and pepper to taste

1. Melt the in a large bowl at P-HI for 1 minute.
2. Add the onion, carrot and potato and cook at P-HI for 6 minutes. stir halfway through cooking.
3. Add the tomatoes, orange juice, orange rind and stock. Mix thoroughly. Season with salt and pepper to taste. Cover the bowl and cook at P-HI for 10 minutes. stir 2-3 times during cooking, until the vegetables are tender.
4. Blend and serve immediately.

FRENCH ONION SOUP

1 large onions, sliced
 1 tbsp (15ml) corn oil
 2 oz.(50g) plain flour
 2 pints(1.2 liters) hot meat
 or vegetable stock
 salt and pepper to taste
 2 tbsp (30ml) parsley, chopped
 4 thick slices French bread
 2 oz.(50g) cheese, grated

1. Place the onion and oil a bowl, mix well and cook at P-HI for 2 minutes.
2. Stir in the flour to make a paste and gradually add stock. Season and add the parsley.
3. Cover the bowl and cook at P-80 for 12 minutes.
4. Pour the soup into serving bowls, submerge bread and sprinkle generously with cheese.
5. Cook at P-80 for 2 minutes, until the cheese has melted.

STIR FRIED VEGETABLES

1 tbsp(15ml) sunflower oil
 2 tbsp (30ml) soy sauce
 1 tbsp (15ml) sherry
 1"(2.5cm) root ginger,
 peeled and finely grated
 2 medium carrots, cut into fine strips
 4 oz.(100g) button mushrooms,
 chopped
 2 oz.(50g) beansprouts
 4 oz.(100g) mange-tout
 1 red pepper, seeded and thinly sliced
 4 spring onions, chopped
 4 oz.(100g) canned water chestnuts,
 sliced
 1/4 head of chinese leaves, thinly sliced

1. Place the oil, soy sauce, sherry, ginger, garlic and carrots in a large bowl, mix thoroughly
2. Cover and cook at P-HI for 3-4 minutes, stirring once.
3. Add the button mushrooms, beansprouts, mange-tout, red pepper, spring onions, water chestnuts and chinese leaves. Mix thoroughly.
4. Cook at P-HI for 4-5 minutes, until the vegetables are tender. Stir 2-3 times during cooking.

Stir fried vegetables are ideally served with meat or fish.

HONEYED CHICKEN

4 boneless chicken breasts
 2 tbsp(30ml) clear honey
 1 tbsp(15ml) whole grain mustard
 1/2 tsp(2.5ml) dried tarragon
 1 tbsp(15ml) tomato puree
 1/4 pint(150ml) chicken stock

1. Place the chicken breasts in a casserole dish.
2. Mix all remaining ingredients together and pour over the chicken. Salt and pepper to taste.
3. Cook at P-HI for 10-12 minutes. Rearrange and coat the chicken with the sauce twice during cooking.

BLUE CHEESE & CHIVE JACKETS

2 baking potatoes,
(approx.9 oz.(250g) each)
2 oz.(50g) butter
4 oz.(100g) blue cheese, chopped
1 tbsp(15ml) fresh chives, chopped
2 oz.(50g) mushrooms, sliced
salt and pepper to taste

1. Prick each potato in several places. Cook at P-HI for 6-8 minutes. Halve and scoop the flesh into a bowl, add the butter, cheese, chives, mushrooms, salt and pepper, mix thoroughly.
2. Pile mixture into the potato skins and place in a flan dish, on the rack.
3. Cook at P-80 for 8 minutes.

WHITE SAUCE

1 oz.(25g) butter
1 oz.(25g) plain flour
1/2 pint(300ml) milk
salt and pepper to taste

1. Place the butter in a bowl and cook at P-HI for 1 minute, until melted.
2. Stir in the flour and whisk in the milk. Cook at P-HI for 2-4 minutes, stirring every 2 minutes until thick and smooth. Season with salt and pepper to taste.

STRAWBERRY JAM

1 1/2 lb.(675g) strawberries, hulled
3 tbsp(45ml) lemon juice
1 1/2 lb.(675g) caster sugar

1. Place strawberries and lemon juice in a very large bowl, heat at P-HI for 5 minutes, or until the fruit has softened. Add sugar, mix well.
2. Cook at P-80 for 14-16 minutes, until setting point*is reached, stir every 4-5 minutes.
3. Pour into hot, clean jars. Cover, seal and label.

** setting point : To determine setting point, place 1 tsp(5ml)jam onto chilled saucer. Allow to stand for 1 minute. Move surface of jam gently with your finger, if the surface wrinkles setting point has been reached.*

PLAIN MICROWAVE CAKE

4 oz.(100g) margarine
4 oz.(100g) sugar
1 eggs
4 oz.(100g) self raising flour, sifted
2-3 tbsp(30-45ml) milk

1. line the base of 8" (20.4cm) cake dish with grease-proof paper.
2. Cream the margarine and sugar together until light and fluffy. Beat in the eggs and fold in the sifted flour alternately with the milk.
3. Pour into prepared container. Cook at P-HI for 3-4 minutes, until a skewer comes out cleanly.
4. Leave the cake to stand for 5 minutes before turning out.

OMELETTES

1/2 oz.(15g) butter
4 eggs
6 tbsp(90ml) milk
salt & pepper

1. Whisk together eggs and milk. Season.
2. Place butter in 10"(26cm) flan dish. Cook at P-HI for 1 minute, until melted. Coat the dish with the melted butter.
3. Pour omelette mixture into flan dish. Cook at P-HI for 2 minutes. whisk mixture and cook again at P-HI for 1 minutes.

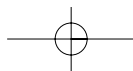

SCRAMBLED EGG

1/2 oz.(15g) butter
2 eggs
2 tbsp(30ml) milk
salt & pepper

1. Melt the butter in a bowl at P-HI for 1 minutes.
2. Add the eggs, milk and seasoning and mix well.
3. Cook at P-HI for 2 minutes, stirring every 30 seconds.

SAVORY MINCE

1 small onion, diced
1 clove garlic, crushed
1 tsp(5ml) oil
7 oz.(200g) can chopped tomatoes
1 tbsp(15ml) tomato puree
1 tsp(5ml) mixed herbs
8 oz.(225g) minced beef
salt and pepper

1. Place onion, garlic and oil in casserole, and cook at P-HI for 2 minutes or until soft.
2. Place all other ingredients in casserole. Stir well.
3. Cover and cook at P-HI for 4 minutes then P-80 for 4-6 minutes or until the meat is cooked.

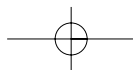
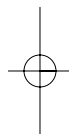
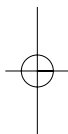



Magic Chef™

Microwave Oven Warranty

Daewoo Electronics America, Inc. warrants each new Microwave Oven to be free from defects in material and workmanship and agrees to remedy any such defect or to furnish a new part(s) (at the company's option) for any part(s) of the unit that has failed during the warranty period. Parts and labor expenses are covered on this unit for a period of one year after the date of purchase. In addition Daewoo Electronics America, Inc. warrants the Magnetron (parts only) to be free from defects in material and workmanship for a period of 8 years. The consumer is responsible for all labor and transportation expenses related to the diagnosis and replacement of the Magnetron after the initial one- year warranty expires. If in the event the unit requires replacement or refund under the terms of this warranty the consumer is responsible for all transportation expenses to return the unit to our factory prior to receiving a replacement unit or refund. **A copy of the dated sales receipt / invoice is required to receive warranty service.**

This warranty covers appliances in use within the continental United States, Puerto Rico and Hawaii. The warranty does not cover the following:

- Damages due to shipping damage or improper installation.
- Damages due to misuse or abuse.
- Content losses due to failure of the unit.
- Repairs performed by unauthorized service agents.
- Service calls that do not involve defects in material and workmanship such as instruction on proper use of the product or improper installation.
- Replacement or resetting of house fuses or circuit breakers.
- Failure of this product if used for other than its intended purpose.

This warranty is in lieu of all warranties expressed or implied and no representative or person is authorized to assume for us any other liability in connection with the sale of this product. Under no circumstances is the consumer permitted to return this unit to the factory without prior written consent from MC Appliance corp.

Model	Parts	Labor	Magnetron (Part Only)	Type of Service
MCD795SW	One-Year	One-Year	Eight Years	Carry In

**For Service or Assistance please call 888 775-0202
Or visit us on the web at www.magicchef-ewave.com**