



1.6 cu. ft. Microwave Oven

MCD1611W / MCD1611B

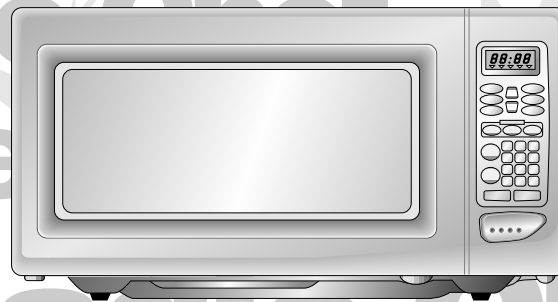
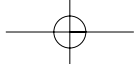

TABLE OF CONTENTS

1. PRECAUTIONS	2
2. IMPORTANT SAFETY INSTRUCTIONS	3
3. FEDERAL COMMUNICATIONS COMMISSION RADIO FREQUENCY	4
4. GROUNDING INSTRUCTIONS	4
5. INSTALLATION	5
6. USE YOUR MICROWAVE OVEN SAFELY	6
7. SPECIFICATIONS	7
8. FEATURES DIAGRAM	8
9. KEYPAD DIAGRAM	9
10. TO STOP THE OVEN WHILE THE OVEN IS OPERATING	10
11. CHILD SAFETY LOCK	10
12. MICROWAVE UTENSILS	11
13. UTENSIL TEST	11
14. OPERATION	12
15. CONTROLS	13
A. SETTING THE CLOCK	13
B. ONE TOUCH COOKING	14
C. SPEEDY COOK	16
D. COOKING IN ONE STAGE	16
E. COOKING IN TWO STAGES	17
F. LESS, MORE	18
G. TIME DEFROSTING	18
H. WEIGHT DEFROSTING	19
I. KITCHEN TIMER MODE	20
16. CARE OF YOUR MICROWAVE OVEN	23
17. WARRANTY	



PRECAUTIONS TO AVOID POSSIBLE EXPOSURE TO EXCESSIVE MICROWAVE ENERGY

- (a) Do not attempt to operate this oven with the door open since open-door operation can result in harmful exposure to microwave energy. It is important not to defeat or tamper with the safety interlocks.
- (b) Do not place any object between the oven front face and the door or allow soil or cleaner residue to accumulate on the sealing surfaces
- (c) Do not operate the oven if it is damaged.
 - * It is particularly important that the oven door close properly and that there is no damage to the following:
 - (I) door (bent),
 - (II) hinges and latches (broken or loosened),
 - (III) door seals and sealing surfaces.
- (d) The oven should not be adjusted or repaired by anyone except properly qualified service personnel.

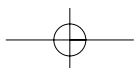
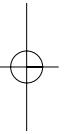
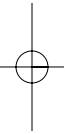

IMPORTANT SAFETY INSTRUCTIONS

When using electrical appliances, basic safety precautions should be followed, including the following: **WARNING**-To reduce the risk of burns, electric shock, fire, injury to persons or exposure to excessive microwave energy:

1. Read all instructions before using the appliance.
2. Read and follow the specific "PRECAUTIONS TO AVOID POSSIBLE EXPOSURE TO EXCESSIVE MICROWAVE ENERGY" found on page 2.
3. This appliance must be grounded. Connect only to properly grounded outlet. See "GROUNDING INSTRUCTIONS" found on page 4.
4. Install or locate this appliance only in accordance with the provided installation instructions.
5. Some products such as whole eggs and sealed containers - for example, closed glass jars-are able to explode and should not be heated in this oven.
6. Use this appliance only for its intended use as described in this manual. Do not use corrosive chemicals or vapors in this appliance. This type of oven is specifically designed to heat, cook, or dry food. It is not designed for industrial or laboratory use.
7. As with any appliance, close supervision is necessary when used by children.
8. Do not operate this appliance if it has a damaged cord or plug, if it is not working properly, or if it has been damaged or dropped.
9. This appliance should be serviced only by qualified service personnel.
Contact nearest authorized service facility for examination, repair or adjustment.
10. Do not cover or block any openings on the appliance.
11. Do not store this appliance outdoors. Do not use this product near water — for example, near a kitchen sink, in a wet basement, or near a swimming pool, or similar locations.
12. Do not immerse cord or plug in water.
13. Keep cord away from heated surfaces.
14. Do not let cord hang over edge of table or counter.
15. Either:
 - a) When cleaning surfaces of door and oven that comes together on closing the door, use only mild, non-abrasive soaps or detergents applied with a sponge or soft cloth , or
 - b) When separate cleaning instructions are provided, See door surface cleaning instructions on.
16. To reduce the risk of fire in the oven cavity:
 - a) Do not overcook food. Carefully attend appliance when paper, plastic, or other com-bustible materials are placed inside the oven to facilitate cooking.
 - b) Remove wire twist-ties from paper or plastic bags before placing bag in oven.
 - c) If materials inside the oven ignite, keep oven door closed, turn oven off, and disconnect the power cord, or shut off power at the fuse or circuit breaker panel.
 - d) Do not use the cavity for storage purposes. Do not leave paper products, cooking utensils, or food in the cavity when not in use.
17. Do not use this microwave oven to heat corrosive chemicals (for example, sulfides and chlorides). Vapours from such corrosive chemicals may interact with the contact and springs of the safety interlock switches thereby rendering them inoperable.
18. Keep the waveguide cover clean at all times. Wipe the oven interior with a soft damp cloth after each use. If you leave grease or fat anywhere in the cavity it may overheat, smoke or even catch fire when next using the oven.
19. Never heat oil or fat for deep frying as you cannot control the temperature and doing so may lead to overheating and fire.
20. Liquids, such as water, coffee, or tea are able to be overheated beyond the boiling point without appearing to be boiling due to surface tension of the liquid. Visible bubbling or boiling when the container is removed from the microwave oven is not always present. **THIS COULD RESULT IN VERY HOT LIQUIDS SUDDENLY BOILING OVER WHEN A SPOON OR OTHER UTENSIL IS INSERTED INTO THE LIQUID.** To reduce the risk of injury to persons:
 - a) Do not overheat the liquid.
 - b) Stir the liquid both before and halfway through heating it
 - c) Do not use straight-sided containers with narrow necks.
 - d) After heating, allow the container to stand in the microwave oven for a short time before removing the container.
 - e) Use extreme care when inserting a spoon or other utensil into the container.

SAVE THESE INSTRUCTIONS

FEDERAL COMMUNICATIONS COMMISSION RADIO FREQUENCY INTERFERENCE STATEMENT (U.S.A ONLY)

WARNING:

This equipment generates and uses ISM frequency energy and if not installed and used properly, that is in strict accordance with the manufacturers instructions, may cause interference to radio and television reception.

It has been type tested and found to comply with limits for an SM equipment pursuant to part 18 of FCC rules, which are designed to provide reasonable protection against such interference in a residential installation.

However, there's no guarantee that interference will not occur in a particular installation.

If this equipment does cause interference to radio or television reception, which can be determined by turning the equipment off and on, the user is encouraged to try to correct the interference by one or more of the following:

- Re-orient the receiving antenna of radio or television.
- Relocate the microwave oven with respect to the receiver. Move the microwave oven away from the receiver.
- Plug the microwave oven into a different outlet so that the microwave oven and receiver are on different branch circuits.

THE MANUFACTURER is not responsible for any radio or TV interference caused by UNAUTHORIZED MODIFICATION to this microwave oven. It is the responsibility of the user to correct such interference

GROUNDING INSTRUCTIONS

This appliance must be grounded. In the event of an electrical short circuit, grounding plug reduces the risk of electric shock by providing an escape wire for electric current. This appliance is equipped with a cord having a grounding wire with a grounding plug. The plug must be plugged into an outlet that is properly installed and grounded.

WARNING:

Improper grounding can result in a risk of electric shock.

Consult a qualified electrician or serviceman if the grounding instructions are not completely understood, or if doubt exists as to whether the appliance is properly grounded, and either:

- (1) If it is necessary to use an extension cord, use only an extension cord that has a 3-blade grounding plug, and a 3-slot receptacle that will accept the plug on the appliance. The marked rating of the extension cord shall be equal to or greater than the electrical rating of the appliance, or
- (2) Do not use an extension cord, if the power supply cord is too short, have a qualified electrician or serviceman install an outlet near the appliance.

INSTALLATION

1 Examine the oven after unpacking

Check for damage such as a mis-aligned door, broken door or a dent in the cavity. If any damage is visible, DO NOT INSTALL, and notify your dealer immediately.

2 Level, flat location

Install the microwave oven on a level, flat surface.

3 Ventilation

Do not block air vents. If they are blocked during operation, the oven may overheat and eventually cause a failure. For proper ventilation, allow 3 inches of space between oven top, sides, rear and adjacent surfaces

4 Away from radio and TV sets

Poor television reception and radio interference may result if the oven is located close to a TV, radio, antenna, etc. Place the oven as far from them as possible.

5 Away from heating appliances and water taps

Keep the oven away from heat, steam or splashing liquids. These things can adversely affect oven wiring and contacts.

6 Power supply

This microwave oven requires a power supply of approximately 15 Amperes, 120 Volts, 60Hz and a grounded outlet. A short power cord is provided to reduce the risk of the user becoming entangled in or tripping over a longer cord. Longer cord sets or extension cords are available and may be used if care is exercised.

If an extension cord is used, the marked electrical rating of the cord should be at least as great as the electrical rating of the oven. The extension cord must be a grounding type 3-wire cord. The longer cord should be arranged so it does not drape over the tabletop or counter where children can pull on it or trip over it.

USE YOUR MICROWAVE OVEN SAFELY

GENERAL USE

Do not attempt to defeat or tamper with safety interlocks.

Do not place any object between the oven front frame and the door or allow residue to build up on the sealing surfaces. Wipe with mild detergent, rinse and dry. Never use abrasive powders or pads.

Do not subject the oven door strain or weight such as a child hanging on an open door. This could cause the oven to fall forward resulting in injury to you and damage to the oven.

Do not operate the oven if door seals or seals surfaces are damaged or if door is bent; or if hinges are loose or broken.

Do not operate the oven empty. This will damage the oven.

Do not attempt to dry clothes, newspapers or other materials in the oven they may catch on fire.

Do not use recycled paper products as they may contain impurities, which may cause sparks or fires.

Do not hit or strike the control panel with hard objects. This can damage the oven.

FOOD

Never use your microwave oven for home canning. The oven is not designed for proper home canning. Improperly canned food may spoil and be dangerous to consume.

Always use the minimum recipe cooking time. It is better to undercook rather than overcook foods. Undercooked foods can be returned to the oven for more cooking. If food is overcooked, nothing can be done.

Heat small quantities of food or foods with low moisture carefully. These can quickly dry out, burn or catch on fire.

Do not heat eggs in the shell. Pressure may build up and eggs can explode.

Potatoes, apples, egg yolks and sausages are examples of food with non-porous skins. These must be pierced before heating

SPECIFICATIONS

POWER SUPPLY		120V AC 60 Hz SINGLE PHASE WITH GROUNDING
MICROWAVE	POWER CONSUMPTION	1500 W
	OUTPUT POWER	1100 W
	FREQUENCY	2450 MHz
OUTSIDE DIMENSIONS (W X H X D)		589 X 339 X 464 mm (23.2X13.3X18.3 in.)
CAVITY DIMENSIONS (W X H X D)		399 X 263 X 426 mm (15.7X10.4X16.8 in.)
NET WEIGHT		APPROX. 18.5KG (40.8 lbs.)
TIMER		99 min. 99 sec.
POWER LEVELS		10 LEVELS

* Specifications are subject to change without notice.

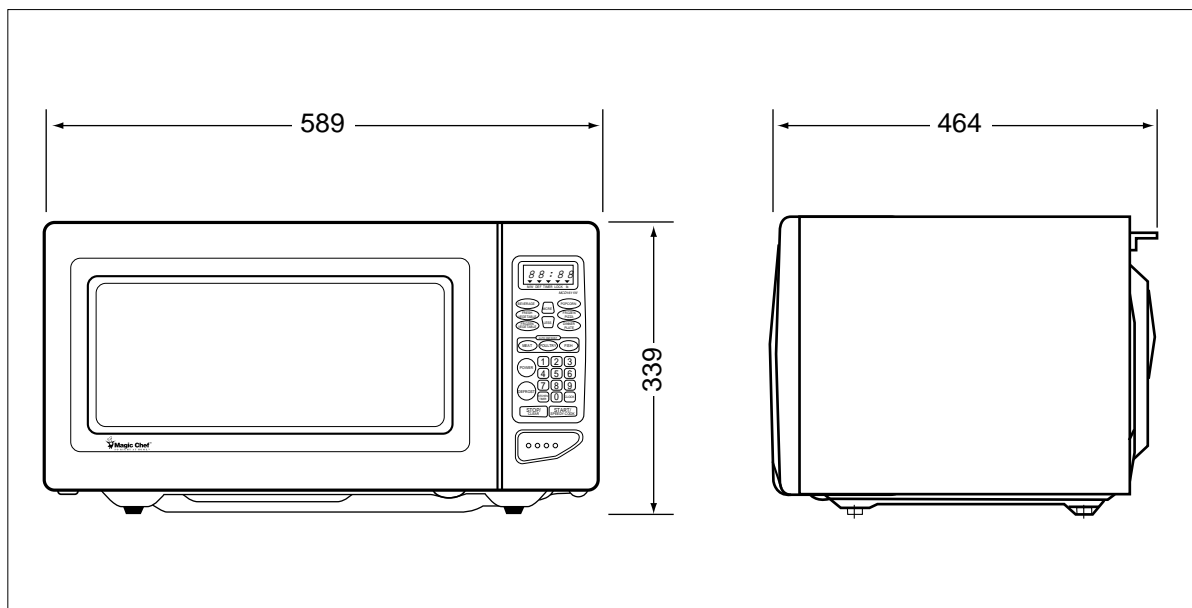

FEATURES DIAGRAM

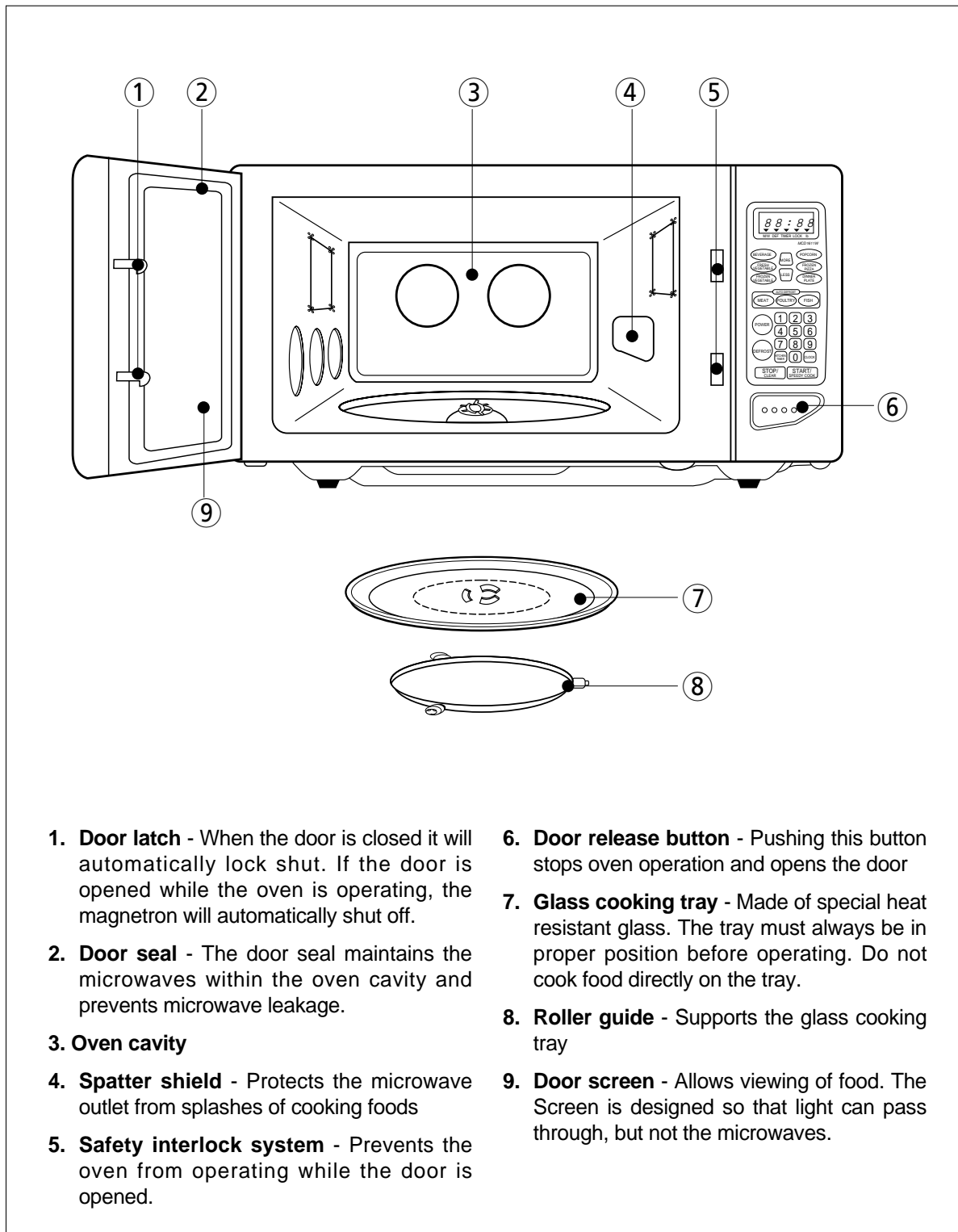

- 1. Door latch** - When the door is closed it will automatically lock shut. If the door is opened while the oven is operating, the magnetron will automatically shut off.
- 2. Door seal** - The door seal maintains the microwaves within the oven cavity and prevents microwave leakage.
- 3. Oven cavity**
- 4. Spatter shield** - Protects the microwave outlet from splashes of cooking foods
- 5. Safety interlock system** - Prevents the oven from operating while the door is opened.
- 6. Door release button** - Pushing this button stops oven operation and opens the door
- 7. Glass cooking tray** - Made of special heat resistant glass. The tray must always be in proper position before operating. Do not cook food directly on the tray.
- 8. Roller guide** - Supports the glass cooking tray
- 9. Door screen** - Allows viewing of food. The Screen is designed so that light can pass through, but not the microwaves.

KEYPAD DIAGRAM

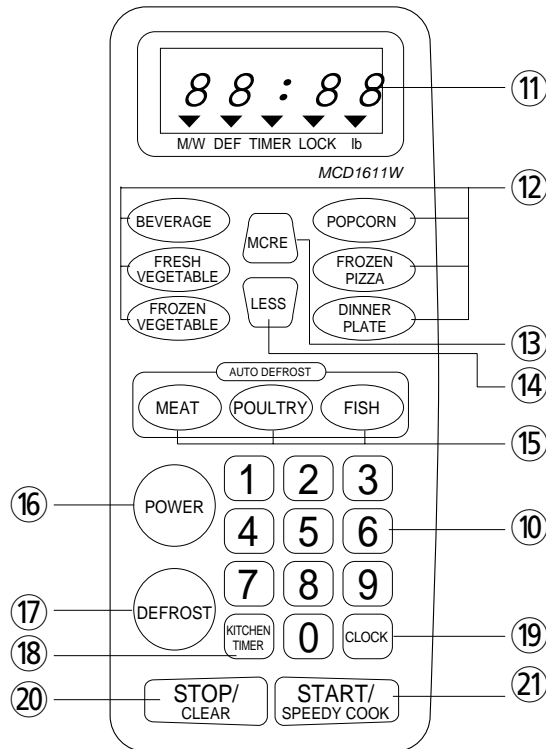

10. Time set pad - Used to set the cooking time and the present time.

11. Display - Cooking time, power level, indicators and present time are displayed here.

12. One touch - Used to cook or reheat specific quantities of these foods. See pages 14~15.

13. More - Used to add time to cooking.

14. Less - Used to remove time from cooking.

15. Auto defrost - Used to defrost foods (by weight)

16. Power - Used to set power level

17. Defrost - Used to defrost foods. (by time)

18. Kitchen Timer - Used as a minute timer, delay start timer cooking, stand timer after cooking and defrosting.

19. Clock - Used to set clock.

20. Stop/Clear - Used to stop the oven operation or to delete the cooking data.

21. Start / Speedy Cook - Used to start the oven and also used to set a reheat time.

TO STOP THE OVEN WHILE THE OVEN IS OPERATING

1. Press STOP/CLEAR pad
 - You can restart the oven by touching START pad.
 - Touch STOP/CLEAR once more to erase all instructions.
 - You must enter in new instructions.
2. Open the door.
 - You can restart the oven by closing the door and touching START.

NOTE: Oven stops operating when door is opened.

CHILD SAFETY LOCK

The safety lock prevents unwanted oven operation such as by small children.

To set, press and hold

 for 3 seconds, LOCK indicator lights.

To cancel, press and hold

 for 3 seconds, LOCK indicator goes off.

MICROWAVE UTENSILS

Glass, Ceramic and China

Ovenproof glass or ceramic baking dishes are the most used microwave utensils.

Many of these items are readily available in most homes: glass measure custard cups, mixing bowls, covered casseroles, pie plates and round or square cake dishes. Ovenproof dinnerware is usually safe to use in the microwave.

Do not heat or cook in glass jars or bottles.

Do not use dishes with silver gold, platinum or other metal trim. Arcing may occur and/or the dish may break.

Do not use delicate or stemmed glassware. Although the glass may be transparent to microwave energy, heat from the food may cause the glassware to crack.

Plastics

Plastic dishes, cups, mugs and bowls may be used in the oven for short periods of time. None of these should be used in the oven for prolonged periods because distortion and melting may occur. Check manufacturer's recommendations concerning microwave safety.

Plastic wrap can be used to cover dishes in most recipes if the dish is deep enough to avoid plastic wrap touching the food. Always vent the wrap by folding back one corner to allow excess steam to escape.

Plastic cooking bags should be slit before cooking so excess steam can escape.

Do not use wire twist ties to close the bag. Wire twist ties can cause arcing which can damage the oven.

Paper

Paper cups, wax paper, napkins, paper towels, and plates may be used for short cooking. Prolonged time in the oven can cause paper to burn. Do not use recycled paper products, such as brown paper bags. They contain impurities, which may cause arcing and damage the oven

Metal

Metal utensils should not be used in the oven. Metal reflects microwave energy so foods will not cook evenly.

Metal can cause arcing and damage the oven.

UTENSIL TEST

Dishes that do not absorb microwave energy are best for microwave cooking. Look on the label to verify that particular cups, glasses, plates are indeed suitable, especially paper goods. If you are not sure, try this utensil test to check

- Put the empty utensil in the microwave oven.
 - Put one cup of water in a glass measure next to the empty utensil.
 - Heat on HI for 1 minute.
 - After 1 minute, the water should be warm but the utensil should not.
- If the utensil is warm. It is not suitable for microwave cooking

OPERATION

This section includes useful information about oven operation.

1. Plug power supply cord into a standard 3 pronged 15 Amp, 120V AC 60Hz power outlet.
2. Place the food in a suitable container.
3. Open the oven door and put the food on the glass tray. (The glass tray and roller guide must always be in place during cooking.)
4. Close the door firmly.

- The oven light is on only when the microwave oven is operating.
- The oven door can be opened at any time during operation by touching the door release button on the control panel. The oven will automatically shut off.
- Each time a pad is touched, a BEEP will sound to acknowledge the touch.
- The oven automatically cooks on full power unless set to a lower power level.
Make sure the oven is properly installed and plugged into the electrical outlet.
- The Display will show “:0” when the oven is plugged in.
- Time Clock returns to the present time when the cooking time ends.
- When the STOP/CLEAR pad is touched during the oven operation, the oven stops cooking and all information is retained. To erase all information (except the present time), touch the STOP/CLEAR pad once more. If the oven door is opened during the oven operation, all information is retained.
- If the START pad is touched and the oven does not operate, check the area between the door and door seal for obstructions and make sure the door is closed securely. The oven will not start cooking until the door is completely closed or the program has been reset.

WATTAGE OUTPUT CHART

- Pressing the POWER pad sets the power-level. The chart shows the display, the power level and the percentage of power.

Touch POWER pad	Power Level (Display)	Approximate Percentage of Power
Once	P-HI	100%
Twice	P-90	90%
3 times	P-80	80%
4 times	P-70	70%
5 times	P-60	60%
6 times	P-50	50%
7 times	P-40	40%
8 times	P-30	30%
9 times	P-20	20%
10 times	P-10	10%
11 times	P-00	0%

CONTROLS

SETTING THE CLOCK

When the oven is first plugged in, the display will flash and a tone will sound. If the AC power ever goes off the display shows “:0” when the power comes back on.



1. Touch **CLOCK** pad.
ONCE for a standard time (12 hour display)
Or
TWICE for military time (24 hour display)

1	2	3
4	5	6
7	8	9
	0	

2. Enter the correct time of day by touching the numbers in sequence



3. Touch **CLOCK** pad. The display stops blinking, and the colon starts blinking. If you selected the 12-hour clock system, this digital clock allows you to set from 1:00 to 12:59. If you selected 24 hour clock system, this digital clock allows you to set from 0:00 to 23:59.

NOTE: If you attempt to enter an incorrect time, the time will not be set and an error signal tone will sound. Touch the **CLOCK** pad and re-enter the time.

ONE TOUCH COOKING

One touch cook allows you to cook or reheat many of your favorite foods by touching just one pad. To increase quantity, touch chosen pad until number in display is same as desired quantity to cook. (except for POPCORN)

POPCORN

1. Touch **POPCORN** pad
once for a 3.5 oz bag.

When you touch POPCORN pad once, "3.5" is displayed.

After the 1.5 seconds, the display shows the cooking time and the oven starts cooking.

- NOTE:**
1. Use prepackaged room-temperature microwave popcorn.
 2. Place bag in oven according to manufacturer's directions.
 3. Pop only one bag at a time.
 4. After popping, open bag carefully: popcorn and steam are extremely hot.
 5. Do not reheat un-popped kernels or reuse bag.
 6. Do not leave oven unattended while popping popcorn.

- CAUTION:**
1. If prepackaged popcorn is of a different weight than the recommended weight do not use the popcorn pad. Follow the manufacturer instruction.
 2. Do not place bag directly on the turntable tray, place bag on microwavable dish when cooking

FROZEN PIZZA

1. Touch **FROZEN PIZZA** pad
once for a 7 oz pizza or twice
for a 14 oz pizza.

When you touch FROZEN PIZZA pad once, "7" is displayed.
After 1.5 seconds, the display shows the cooking time and the oven starts cooking.

- 7 oz: 7 oz Touch FROZEN PIZZA once.
- 14 oz: 14 oz Touch FROZEN PIZZA twice within 1.5 seconds.

- NOTE:**
1. Use only frozen pizza at a time.
 2. Use only frozen pizza made for microwave ovens.
 3. If the cheese of frozen pizza does not melt sufficiently, cook a few seconds longer.
 4. Some brands of frozen pizza may required more or less cooking time.

BEVERAGE

1. Touch **BEVERAGE** pad
once for 1 cup, twice for 2 cups or
three times for 3 cups.

When you touch BEVERAGE pad once, "1" is displayed.
After 1.5 seconds, the display shows the cooking time
and the oven starts cooking.

- * **BEVERAGE** (200ml/cup)
- 1 cup(mug) Touch BEVERAGE once.
 - 2 cups(mugs) Touch BEVERAGE twice within 1.5 seconds.
 - 3 cups(mugs) Touch BEVERAGE three times within 1.5 seconds.

ONE TOUCH COOKING (CONTINUED)

DINNER PLATE

1. Touch  pad
once for a 12 oz dinner plate,
twice for a 15 oz dinner plate.

When you touch DINNER PLATE pad once,
“12” is displayed.
After 1.5 seconds, the display shows the cooking time and
the oven starts cooking.

- * DINNER PLATE**
- 12 oz: Touch DINNER PLATE once.
 - 15 oz: Touch DINNER PLATE twice within 15 seconds.

FRESH VEGETABLE

1. Touch  pad
once for a 7 oz of fresh vegetable,
twice for 14 oz of fresh vegetable.

When you touch FRESH VEGETABLE pad
once, “7” is displayed.
After 1.5 seconds, the display shows cooking time and
the oven starts cooking.

- * FRESH VEGETABLE**
- 7 oz: Touch FRESH VEGETABLE once.
 - 14 oz: Touch FRESH VEGETABLE twice within 1.5 seconds.

FROZEN VEGETABLE

1. Touch  pad
once for a 7 oz of frozen vegetable,
twice for 14 oz of frozen vegetable.

When you touch FROZEN VEGETABLE pad once,
“7” is displayed.
After 1.5 seconds, the display shows cooking time and
the oven starts cooking.

- * FROZEN VEGETABLE**
- 7 oz: Touch FROZEN VEGETABLE
 - 14 oz: Touch FROZEN VEGETABLE twice within 1.5 seconds.

SPEEDY COOK

SPEEDY COOK allows you to reheat for 30 seconds at 100% (full power) by simply touching the SPEEDY COOK pad. By repeatedly touching the SPEEDY COOK pad, you can also extend re-heating time to 5 minutes by 30 second increments.

1. Touch  pad.

When you touch SPEEDY COOK, “:30” is displayed.
After 1.5 seconds, the oven starts re-heating.

COOKING IN ONE STAGE

1. Touch  pad
repeatedly to select desired
power level.

The M/W indicator lights.
The display will show what you touched.

NOTE: If step 1 is omitted, the oven will cook at full power.

2. Touch the for the cooking time.

1	2	3
4	5	6
7	8	9
	0	

3. Touch  pad.

NOTE: Your oven can be programmed For 99 minutes 99 second. (99:99)

When you touch START pad, the M/W indicator starts blinking to show the oven is cooking. The display counts down the time to show how much cooking time is left. When the cooking time ends, you will hear beeps.

NOTE: Using lower power levels increases the cooking time which is recommended for foods such as cheese, milk and slow cooking of meats.

COOKING IN TWO STAGES

All recipes require frozen foods to be defrosted fully before cooking. This oven can be programmed to automatically defrost foods before cooking.

1. Touch  pad.

The DEFROST indicator lights and “:0” is displayed and the lb indicator starts blinking.

2. Touch

1	2	3
4	5	6
7	8	9
	0	

The display will show the numbers you pressed in the order you touched.

for the defrosting time you want.

3. Touch



to select desired power level.

The MAN indicator lights and “P-HI” is displayed. The display will show what you touched.

4. Touch

1	2	3
4	5	6
7	8	9
	0	

The display will show the number you touched.

for desired cooking time.

5. Touch  pad.

- When you touch START pad, the DEFROST and M/W indicators come on to confirm the power levels selected.
- The DEFROST indicator starts blinking to show you that the oven is in DEFROST mode.
- The display counts down the time remaining in DEFROST mode.
- When the oven beeps, turnover, break apart and redistribute the food. At the end of DEFROST mode, the oven will beep and start M/W cook.
- The DEFROST indicator goes off and the M/W indicator starts blinking. The display counts down the time remaining in M/W cook.

LESS, MORE



- To alter one-touch cooking or cooking time whilst oven is in operation, use LESS or MORE.(except for defrosting).
- Press LESS/MORE to decrease/increase the one-touch cooking time in multiples of 10 seconds.
- The overall one-touch cooking time can be increased to a maximum of 99 minutes 50 second.
- Press LESS/MORE to decrease & increase the cooking time in multiples of 1 minute.
- The overall cooking time can be increased to a maximum of 99 minutes.

TIME DEFROSTING

When TIME DEFROST is selected the automatic cycle divides the defrosting time into periods of alternating defrost and stand times by cycling on and off.

1. Touch  pad

The DEFROST indicator lights and “:0” is displayed

2. Touch

1	2	3
4	5	6
7	8	9
	0	

The display will show the numbers you pressed in the order you touched.

for the desired defrosting time.

3. Touch  pad.



NOTE: Your oven can be programmed for 99 minutes 99 seconds (99:99)

When you touch START pad, the DEFROST indicator starts blinking to show the oven is in the DEFROST mode. The display counts down the time to show you how much defrosting time is left in the DEFROST mode. The oven beeps during the defrosting cycle to signal that the food needs to be turned or rearranged. When the defrosting time ends, you will hear 3 beeps.



WEIGHT DEFROSTING

WEIGHT DEFROSTING lets you easily defrost food by eliminating guesswork in determining defrosting time. Follow the steps below for easy defrosting.



MEAT

1. Touch  pad repeatedly to select desired defrosting weight. The DEFROST & lb indicator light and "1.0" is displayed. The display will show what you touched.
2. Touch  pad. MEAT DEFROSTING begins.

POULTRY

1. Touch  pad repeatedly to select desired defrosting weight. The DEFROST & lb indicator light and "1.5" is displayed. The display will show what you touched.
2. Touch  pad. POULTRY DEFROSTING begins.

FISH

1. Touch  pad repeatedly to select desired defrosting weight. The DEFROST & lb indicator light and "0.5" is displayed. The display will show what you touched.
2. Touch  pad. FISH DEFROSTING begins.

* WEIGHT DEFROST CHART

Touch pad	MEAT	POULTRY	FISH
once	1.0 lb	1.5 lb	0.5 lb
twice	1.5 lb	2.0 lb	1.0 lb
3 times	2.0 lb	2.5 lb	1.5 lb
4 times	2.5 lb	3.0 lb	2.0 lb

The defrosting time is automatically determined by the weight selected. The lb indicator goes off and the DEFROST indicator blinks and the defrosting time counts down in the display window. The oven beeps during the defrosting cycle to signal that the food needs to be turned or rearranged. When the defrosting time ends you will hear beeps.

KITCHEN TIMER MODE

Timer operates as a minute timer which can be set to delay cooking and used as a hold setting after cooking. However delayed cooking can not be programmed for defrost. Timer operates without microwave energy.

HOW TO USE AS A MINUTE TIMER

1. Touch  pad. The KITCHEN TIMER indicator lights and “:0” is displayed.

2. Press

The display will show the numbers you pressed in the order you touched.

1	2	3
4	5	6
7	8	9
	0	

for amount of time you want to count down.

3. Touch  pad. The display counts down the time remaining in KITCHEN TIMER mode. When KITCHEN TIMER mode ends, you will hear 3 beeps.

HOW TO USE THE KITCHEN TIMER FUNCTION, TO DELAY THE START OF COOKING

1. Touch  pad. The KITCHEN TIMER indicator lights and “:0” is displayed.

2. Press

The display will show the numbers you pressed in the order you touched.

1	2	3
4	5	6
7	8	9
	0	

for the amount of time
you want to delay.

3. Touch  repeatedly to select the desired power level.

4. Touch

1	2	3
4	5	6
7	8	9
	0	

for the desired cooking time.

5. Touch  button. The kitchen timer will begin counting down to zero and cooking will then begin.

HOW TO USE KITCHEN TIMER MODE, TO SET A STANDING TIME

1. Touch  pad.

The KITCHEN TIMER indicator lights and “:0” displayed.

2. Touch

The display will show the numbers you pressed in the order you touched

1	2	3
4	5	6
7	8	9
	0	

to program desired defrosting time

3. Touch  pad.

5. Press

The display will show the numbers you pressed in the order you touched

1	2	3
4	5	6
7	8	9
	0	

the for the amount of time you want the food to stand after cooking.

5. Touch  pad.

Defrosting will start. After defrosting, stand time will count down

NOTE: Your oven can be programmed for 99 minutes 99 seconds. (99:99)

CARE OF YOUR MICROWAVE OVEN

- 1 Turn the oven off before cleaning.
- 2 Keep the inside of the oven clean. When food spatters or spilled liquids adhere to oven walls, wipe with a damp cloth. Mild detergent maybe used if the oven gets very dirty. The use of harsh detergent or abrasives is not recommended.
- 3 The outside oven surface should be cleaned with soap and water, rinsed and dried with a soft cloth. To prevent damage to the operating parts inside the oven, water should not be allowed to seep into the ventilation openings
- 4 If the Control Panel becomes wet, clean with a soft, dry cloth. Do not use harsh detergents or abrasives on Control Panel.
- 5 If steam accumulates inside or around the outside of the oven door, wipe with a soft cloth. This may occur when the microwave oven is operated under high humidity conditions and in no way indicates malfunction of the unit.
- 6 It is occasionally necessary to remove the glass tray for cleaning. Wash the tray in warm sudsy water or in a dishwasher.
- 7 The roller guide and oven cavity floor should be cleaned regularly to avoid excessive noise. Simply wipe the bottom surface of the oven with mild detergent water or window cleaner and dry. The roller guide may be washed in mild sudsy water.

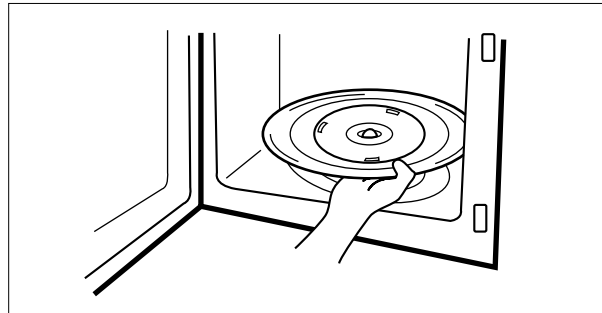

ROLLER GUIDE

1. The ROLLER GUIDE and oven floor should be cleaned frequently to prevent excessive noise.
2. The ROLLER GUIDE MUST ALWAYS be used for cooking together with the Glass Tray.

GLASS TRAY

1. DO NOT operate the oven without the Glass Tray in place.
2. DO NOT use any other Glass Tray with this oven.
3. If Glass Tray is hot, ALLOW TO COOL before cleaning or placing it in water.
4. DO NOT cook directly on the Glass Tray. Always use a microwavable dish.

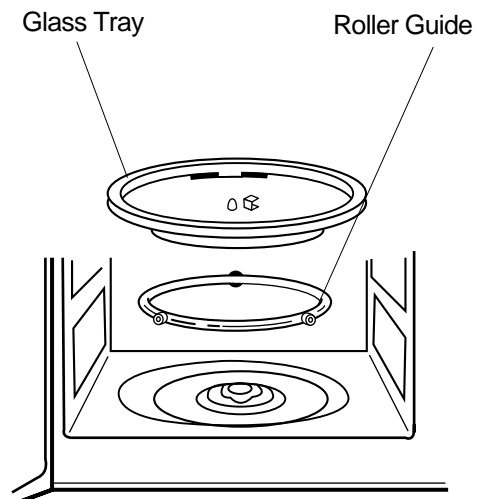



Magic Chef™
SO RIGHT AT HOME.™

Microwave Oven Warranty

MC Appliance corp. warrants each new Microwave Oven to be free from defects in material and workmanship and agrees to remedy any such defect or to furnish a new part(s) (at the company's option) for any part(s) of the unit that has failed during the warranty period. Parts and labor expenses are covered on this unit for a period of one year after the date of purchase. In addition MC Appliance corp, Inc. warrants the Magnetron (parts only) to be free from defects in material and workmanship for a period of 8 years. The consumer is responsible for all labor and transportation expenses related to the diagnosis and replacement of the Magnetron after the initial one- year warranty expires. If in the event the unit requires replacement or refund under the terms of this warranty the consumer is responsible for all transportation expenses to return the unit to our factory prior to receiving a replacement unit or refund. **A copy of the dated sales receipt / invoice is required to receive warranty service.**

This warranty covers appliances in use within the continental United States, Puerto Rico and Hawaii. The warranty does not cover the following:

- Damages due to shipping damage or improper installation.
- Damages due to misuse or abuse.
- Content losses due to failure of the unit.
- Repairs performed by unauthorized service agents.
- Service calls that do not involve defects in material and workmanship such as instruction on proper use of the product or improper installation.
- Replacement or resetting of house fuses or circuit breakers.
- Failure of this product if used for other than its intended purpose.
- Disposal cost of failed units not returned to our factory.
- Any delivery / installation costs incurred as the result of a unit that fails to perform as specified.

This warranty is in lieu of all warranties expressed or implied and no representative or person is authorized to assume for us any other liability in connection with the sale of this product. Under no circumstances is the consumer permitted to return this unit to the factory without prior written consent from MC Appliance corp.

Model	Parts	Labor	Magnetron (Part Only)	Type of Service
MCD1611W	One-Year	One-Year	Eight Years	Carry In
MCD1611B	One-Year	One-Year	Eight Years	Carry In

For Service or Assistance please call 888 775-0202
Or visit us on the web at www.mcappliance.com