

# **KitchenAid®**

## *Countertop Microwave Oven*

**Models KCMS122Y  
KCMS125Y**

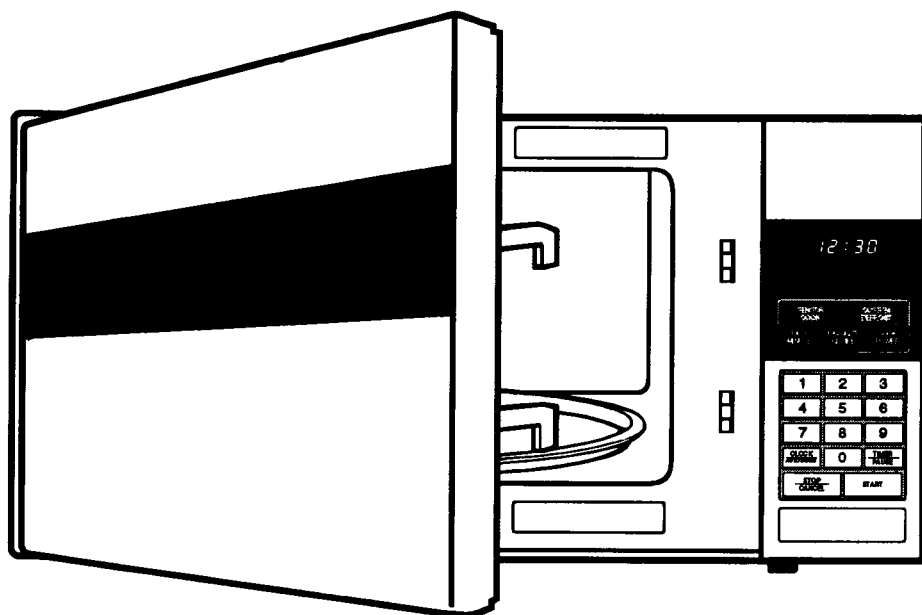

**USE and CARE GUIDE**

# Contents

	Page
<b>Registration</b> .....	2
<b>Important Safety Instructions</b> .....	3
<b>You Are Responsible For</b> .....	4
<b>Precautions To Avoid Possible Exposure To Excessive Microwave Energy</b> .....	4
<b>Getting Acquainted</b> .....	5
Microwave oven features .....	5
Control panel features .....	6
Quick reference cooking guide .....	7
<b>Using Your Microwave Oven</b> .....	10
Microwave oven controls .....	10
Audible signals .....	11
Using the safety lock .....	11
Setting the clock .....	11
Using the Minute Timer .....	12
Using STOP/CANCEL .....	12
Cooking in your microwave oven .....	13
Cooking at high cook power .....	13
Cooking at lower cook powers .....	13
Using CUSTOM DEFROST .....	14
Cooking with more than one cook cycle .....	16
Using SENSOR COOK .....	17
Using FAVORITE RECIPE .....	18
Using EASY MINUTE .....	19
Using PAUSE .....	19
Using AUTO START .....	20
Microwave cooking chart .....	21
<b>Installation Instructions</b> .....	22
Installing your microwave oven .....	22
Grounding instructions .....	23
<b>Caring For Your Microwave Oven</b> .....	24
Cleaning the microwave oven .....	24
<b>How Your Microwave Oven Works</b> .....	25
<b>Operating Safety Precautions</b> .....	26
<b>Questions And Answers</b> .....	30
<b>If You Need Service Or Assistance</b> .....	31
<b>KitchenAid Warranty</b> .....	Back Cover

©1994 KitchenAid

# Registration

Please fill out and mail your Ownership Registration Card packed with the Literature Package. This card will enable us to contact you in the unlikely event of a product safety notification and assist us in complying with the provisions of the Consumer Product Safety Act. Return of this card is not necessary to validate your warranty.

You must provide proof of purchase or installation date for in-warranty service.

Write down the following information. You will need it if your microwave ever requires service.

---

**Model Number\***

---

**Serial Number\***

---

**Date Purchased**

---

**Date Installed**

---

**Builder's or Dealer's Name**

---

**Address**

---

**Phone**

\*Model and serial numbers are located on a plate behind oven door on frame.

# IMPORTANT SAFETY INSTRUCTIONS

Microwave ovens have been thoroughly tested for safe and efficient operation. However, as with any appliance, there are special installation and safety precautions which must be followed to ensure safe and satisfactory operation and prevent damage to the unit.

## WARNING

To reduce the risk of burns, fire, electrical shock, injury to persons, exposure to excessive microwave energy, or damage when using the microwave oven, follow basic precautions, including the following:

- Read all instructions before using the microwave oven.
- Read and follow the specific "PRECAUTIONS TO AVOID POSSIBLE EXPOSURE TO EXCESSIVE MICROWAVE ENERGY" found on page 4.
- This appliance must be grounded. Connect only to properly grounded outlet. See "GROUNDING INSTRUCTIONS" found on page 23.
- Install or locate this appliance only in accordance with the provided Installation Instructions found on page 22.
- Some products such as whole eggs and sealed containers—for example, closed glass jars—may explode and should not be heated in this oven.
- Use this appliance only for its intended use as described in this manual. Do not use corrosive chemicals or vapors in this appliance. This type of oven is specifically designed to heat, cook, or dry food. It is not designed for industrial or laboratory use.
- As with any appliance, close supervision is necessary when used by children.
- Do not operate this appliance if it has a damaged cord or plug, if it is not working properly, or if it has been damaged or dropped. Electrical shock, fire or other hazards may result.
- This appliance should be serviced only by qualified service personnel. Call an authorized KitchenAid service company for examination, repair or adjustment.
- Do not cover or block any opening on the appliance. Fire may result.
- Do not store or use this appliance outdoors. Do not use this product near water—for example, near a kitchen sink, in a wet basement, or near a swimming pool, and the like.
- Do not immerse cord or plug in water.
- Keep cord away from heated surfaces.
- Do not let cord hang over edge of table or counter.
- See door surface and interior cleaning instructions on page 24.
- To reduce the risk of fire in the oven cavity:
  - Do not overcook food. Carefully attend appliance if paper, plastic, or other combustible materials are placed inside the oven to facilitate cooking. Paper can char or burn, and some plastics can melt if used when heating foods.
  - Do not deep fry in oven.
  - **Test dinnerware or cookware before using.** See page 29. Some dishes (melamine, some ceramic dinnerware, etc.) absorb microwave energy, becoming too hot to handle and slowing cooking times. Cooking in metal containers not designed for microwave use can damage the oven, as can containers with hidden metal (twist-ties, foil lining, staples, metallic glaze or trim).
  - Remove wire twist-ties from paper or plastic bags before placing bag in oven.
  - If materials inside the oven should ignite, keep oven door closed, turn oven off, and disconnect the power cord, or shut off power at the fuse or circuit breaker panel.
  - Do not use the cavity for storage purposes. Do not leave paper products, cooking utensils, or food in the cavity when not in use.
- Read and follow "Operating Safety Precautions" starting on page 26.
  1. A short power-supply cord is provided to reduce the risks resulting from becoming entangled in or tripping over a longer cord.
  2. Longer cord sets or extension cords are available and may be used if care is exercised in their use.
  3. If a long cord or extension cord is used temporarily, (a) the marked electrical rating of the cord set or extension cord should be at least as great as the electrical rating of the appliance, (b) the extension cord must be a grounding-type, 3-wire cord that has a 3-blade grounding plug and a 3-slot receptacle that will accept the plug on the appliance, and (c) the longer cord should be arranged so that it will not drape over the countertop or tabletop where it can be pulled on by children or tripped over accidentally.
  4. A qualified electrician must install a properly grounded and polarized 3-prong receptacle near the appliance.

- If your microwave oven is wall-mounted or under-cabinet:
  - Do not operate any heating or cooking appliance beneath this appliance.
  - Do not mount this unit over or near any portion of a heating or cooking appliance.
  - Do not mount over a sink.
  - Do not store anything directly on top of the appliance surface when the appliance is in operation.

**– SAVE THESE INSTRUCTIONS –**

## You Are Responsible For

- Installing and leveling the oven on a surface strong enough to support its weight, and where it is protected from the elements.\* The microwave oven should be at a temperature above 50°F (10°C) for proper operation.
  - Properly connecting the oven to electrical supply and grounding it.\*
  - Making sure the oven is not used by anyone unable to operate it properly.
  - Properly maintaining the oven.
  - Using the microwave oven only as described in this manual.
- \*See the Installation Instructions on page 22.

## PRECAUTIONS TO AVOID POSSIBLE EXPOSURE TO EXCESSIVE MICROWAVE ENERGY...

**Do not attempt to operate this oven with the door open since open-door operation can result in harmful exposure to microwave energy. It is important not to defeat or tamper with the safety interlocks.**

**Do not place any object between the oven front face and the door or allow soil or cleaner residue to accumulate on sealing surfaces.**

**Do not operate the oven if it is damaged. It is particularly important that the oven door close properly and that there is no damage to the:**

- (1) Door (bent),
- (2) Hinges and latches (broken or loosened),
- (3) Door seals and sealing surfaces.

**Do not operate the microwave oven if the door window is broken.**

The microwave oven should be checked for microwave leakage by qualified service personnel after a repair is made.

The oven should not be adjusted or repaired by anyone except properly qualified service personnel.

**Do not operate the microwave oven with the outer cabinet removed.**

# Getting Acquainted

## Microwave oven features

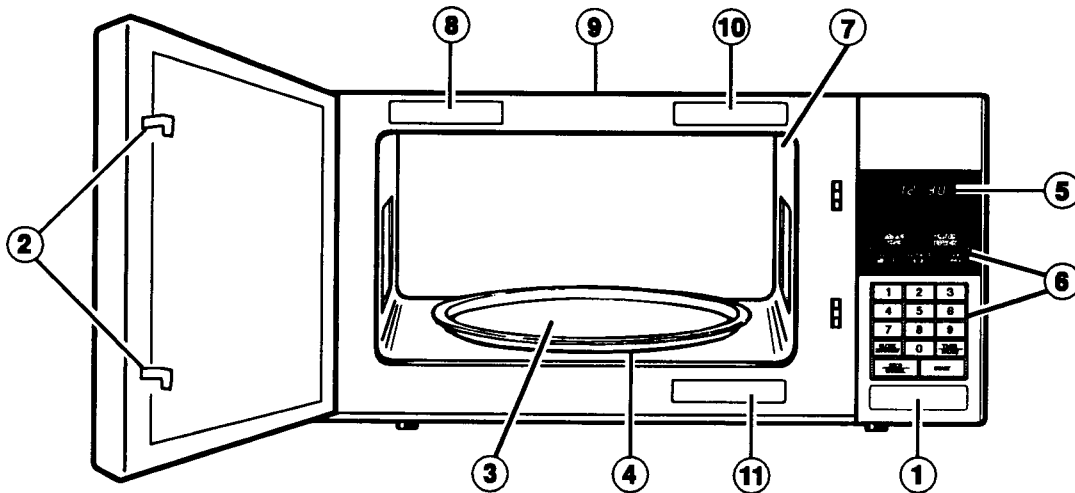

Your microwave oven is designed to make your cooking experience as enjoyable and productive as possible. To help get you up and running quickly, the following is a list of the oven's basic features:

1. **One-Touch Door Open Button.** Push to open door.
2. **Door Safety Lock System.** The oven will not operate unless the door is securely closed.
3. **Glass Turntable.** This turntable turns food as it cooks for more even cooking. It must be in oven during operation for best cooking results. See pages 24 and 28 for more details.
4. **Removable Turntable Support** (under turntable).
5. **Time and Indicator Display.**
6. **Control Panel.** Touch pads on this panel to perform all functions. See page 6 for more details.
7. **Light.** Automatically turns on when door is opened or when oven is operating.
8. **Model and Serial Number Plate.**
9. **External Oven Air Vents** (on back). See page 22 for more details.
10. **Custom Defrost Label.** This label lists the settings you can use with CUSTOM DEFROST. See page 14 for more details.
11. **Sensor Cook Label** (KCMS125Y only). This label lists the settings you can use with Sensor Cook. See page 17 for more details.

### Built-in kits

You can build in your microwave oven by using one of the following trim kits:

SIZE	COLOR	KIT MODEL NO.	KIT NO.	FOR INSTALLATION OVER OVEN MODEL
24"	White	MK6124XAQ	4319224	SB130PER, SB160PEX KEBI141Y, RB160PXY, RB120PXY, RB100PXY, RB1005XY
27"	White	MK6127XAQ	4319226	SB130PER, SB160PEX RB760PXY, KEBI171Y, KEBS177Y
27"	Almond	MK6127XAZ	4319247	Same as Kit No. 4319226
30"	White	MK6120XAQ	4378059	RB260PXY, RB220PXY, KEBI100Y, KEBS107Y
30"	Almond	MK6120XAZ	4319246	Same as Kit No. 4378059
30" (Model KCMS125Y only)	Grey	MK6120XAY	4319245	Same as Kit No. 4378059

See page 22 for more information.

## Control panel features

### KCMS122Y

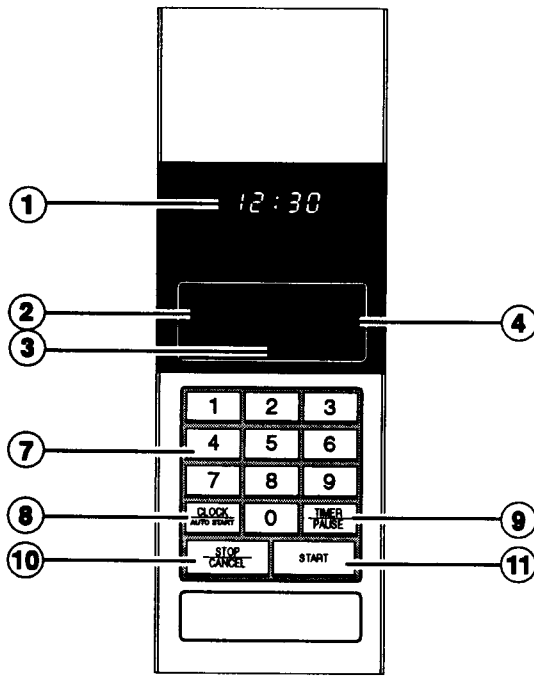

### KCMS125Y

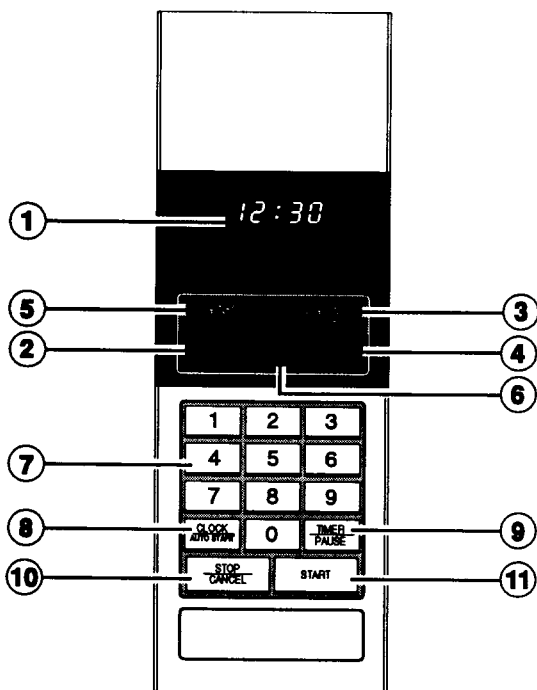



Your microwave oven control panel lets you select the desired cooking function quickly and easily. All you have to do is touch the necessary Command Pad. The following is a list of all the Command and Number Pads located on the control panel. For more information, see pages 10-21.

1. **Display.** This display includes clock and indicators to tell you time of day, cooking time settings and cooking functions selected. See page 10 for more information.
2. **EASY MINUTE.** Touch this pad to cook for 1 minute at 100% Cook Power or to add a minute to cooking time. See page 19 for more information.
3. **CUSTOM DEFROST.** Touch this pad followed by a setting selection to thaw frozen food before cooking. See page 14 for more information.
4. **COOK POWER.** Touch this pad followed by a Number Pad to set the amount of microwave energy released to cook the food. The higher the number, the higher the power or "heat." See page 14 for more information. See "Microwave cooking chart" on page 21 for specific Cook Powers to use for the food you are cooking.
5. **SENSOR COOK (KCMS125Y only).** Touch this pad followed by a setting selection to cook food by amount of moisture and humidity emitted by the food during cooking. See page 17 for more information.
6. **FAVORITE RECIPE (KCMS125Y only).** Touch this pad to recall one cooking instruction previously programmed into memory. See page 18 for more information.
7. **Number Pads.** Touch Number Pads to enter cooking times, Cook Powers, quantities or weights.
8. **CLOCK/AUTO START.** Touch this pad to enter the correct time of day or to program your oven to begin cooking automatically at a designated time later in the day. See pages 11 and 20 for more information.
9. **TIMER/PAUSE.** Touch this pad to set the Minute Timer or to program the oven to stop (pause) between cooking stages. See pages 12 and 19 for more information.
10. **STOP/CANCEL.** Touch this pad once to erase an incorrect command, cancel the Minute Timer or stop the oven temporarily during cooking. Touch it twice to cancel a program during cooking or to clear the Display. See page 12 for more information.
11. **START.** Touch this pad after setting a function on the microwave oven to start the function. If you open the door, retouch START to continue cooking.

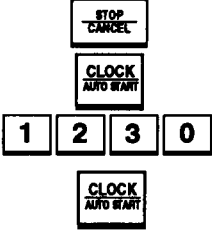
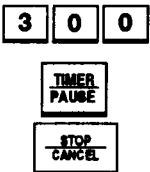

## Quick reference cooking guide

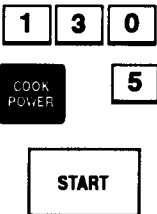
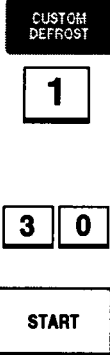
Your microwave oven gives you a wide range of cooking capabilities. The following chart can be used as a quick reference when cooking. For more in-depth information, see the corresponding sections in this Use and Care Guide.

If you want to ...	You ...	Example ...
<p><b>Set the clock</b> Setting the clock to the correct time of day lets you set start times with the Auto Start feature. The microwave clock also provides an accurate source of time for your kitchen.</p>	<ol style="list-style-type: none"> <li>1. Touch STOP/CANCEL.</li> <li>2. Touch CLOCK/AUTO START.</li> <li>3. Enter the correct time of day by touching the necessary Number Pads.</li> <li>4. Touch CLOCK/AUTO START again.</li> </ol>	
<p><b>Use the Minute Timer</b> The Minute Timer lets you time any cooking activities in your kitchen.</p>	<ol style="list-style-type: none"> <li>1. Touch Number Pads to enter the desired time.</li> <li>2. Touch TIMER/PAUSE.</li> <li>3. To clear the Minute Timer, touch STOP/CANCEL.</li> </ol>	
<p><b>Cook at high power</b> High power cooking is perfect for quick cooking of small items and separate portions.</p>	<ol style="list-style-type: none"> <li>1. Put food in the oven and close the door.</li> <li>2. Touch Number Pads for the cooking time you want.</li> <li>3. Touch START.</li> </ol>	
<p><b>Cook at lower powers</b> Cooking at lower powers is necessary for efficient cooking of most foods. Failure to use the correct Cook Power may result in overcooking or undercooking.</p>	<ol style="list-style-type: none"> <li>1. Put food in the oven and close the door.</li> <li>2. Touch Number Pads for the cooking time you want.</li> <li>3. Touch COOK POWER.</li> <li>4. Touch a Number Pad for the Cook Power you want.</li> <li>5. Touch START.</li> </ol>	
<p><b>Defrost automatically</b> Your microwave oven automatically defrosts a variety of common meats at preset cook powers for preset times.</p>	<ol style="list-style-type: none"> <li>1. Put food in the oven and close the door.</li> <li>2. Touch CUSTOM DEFROST.</li> <li>3. Enter the desired Custom Defrost setting by touching the correct Number Pad. (See list of settings on Custom Defrost label located behind door on oven frame.)</li> <li>4. Touch Number Pads for the weight of the item to be defrosted. (See note on page 15.)</li> <li>5. Touch START.</li> </ol>	

continued on next page

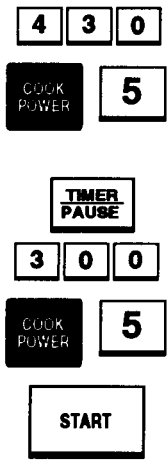
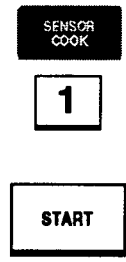
**Getting Acquainted  
Continued**

If you want to ...	You ...	Example ...
<p><b>Cook with more than one cook cycle and use Pause</b> Cooking with two or three cycles lets you cook at different Cook Powers, one after another. When using this function, you are able to fine-tune your cooking for better results.</p>	<ol style="list-style-type: none"> <li>Put food in the oven and close the door.</li> <li>Touch Number Pads for the cooking time you want.</li> <li>Touch <b>COOK POWER</b> twice for 100% Cook Power, or <b>COOK POWER</b> followed by a Number Pad for a lower Cook Power in the first cycle.</li> <li>Touch <b>TIMER/PAUSE</b> if a pause is desired.</li> <li>Touch Number Pads for the cooking time you want in the second cycle.</li> <li>Touch <b>COOK POWER</b> and a Number Pad for the Cook Power you want in the second cycle.</li> <li>Touch <b>START</b>.</li> </ol>	 <p>The diagram illustrates the sequence of button presses for multiple cook cycles. It starts with a row of three number pads: 4, 3, and 0. Below this is a COOK POWER button followed by a 5 number pad. Then a TIMER/PAUSE button. This is followed by another row of three number pads: 3, 0, and 0. Below that is another COOK POWER button followed by a 5 number pad. Finally, a START button is shown at the bottom.</p>
<p><b>Cook with SENSOR COOK</b> Cooking with <b>SENSOR COOK</b> takes the guesswork out of microwave cooking. When using this function, the microwave oven automatically adjusts cooking times and powers according to the amount of moisture and humidity emitted from the food as it heats.</p>	<ol style="list-style-type: none"> <li>Put food in the oven and close the door.</li> <li>Touch <b>SENSOR COOK</b>.</li> <li>Enter the desired Sensor Cook setting by touching the correct Number Pad. (See the Sensor Cook label located behind door on oven frame.)</li> <li>Touch <b>START</b>.</li> </ol>	 <p>The diagram shows the sequence for the Sensor Cook function: a SENSOR COOK button, followed by a 1 number pad, and finally a START button.</p>
<p><b>Cook with FAVORITE RECIPE</b> Touching <b>FAVORITE RECIPE</b> allows you to recall one cooking instruction previously placed in memory.</p>	<ol style="list-style-type: none"> <li>Put food in oven and close the door.</li> <li>Touch <b>FAVORITE RECIPE</b>.</li> <li>Touch <b>START</b>.</li> </ol>	 <p>The diagram shows the sequence for the Favorite Recipe function: a FAVORITE RECIPE button, followed by a START button.</p>
<p><b>Add a minute to your cooking</b> Touching <b>EASY MINUTE</b> lets you cook for a minute at 100% Cook Power.</p>	<ol style="list-style-type: none"> <li>Make sure food is in the oven and the door is closed.</li> <li>Touch <b>EASY MINUTE</b>.</li> </ol>	 <p>The diagram shows the sequence for the Easy Minute function: a single EASY MINUTE button.</p>



If you want to ...	You ...	Example ...
<p><b>Start cooking automatically at a later time</b>                      The Auto Start feature is a handy way to start cooking a meal whenever you want, even when you are not there.</p>	<ol style="list-style-type: none"> <li>1. Put food in oven and close the door.</li> <li>2. Touch Number Pads to enter the desired start time.</li> <li>3. Touch CLOCK/AUTO START.</li> <li>4. Touch Number Pads to enter the amount of cooking time you want.</li> <li>5. Touch Cook Power if cooking at a lower than full (100%) Cook Power.</li> <li>6. Touch the Number Pad for the Cook Power you want.</li> <li>7. Touch START.</li> </ol>	<p>The diagram illustrates the sequence of button presses for the Auto Start feature. It consists of the following elements:</p> <ul style="list-style-type: none"> <li>A row of three number pads: 4, 3, 0.</li> <li>A button labeled "CLOCK" with "AUTO START" written below it.</li> <li>A row of four number pads: 1, 2, 3, 0.</li> <li>A button labeled "COOK" with "POWER" written below it.</li> <li>A number pad: 5.</li> <li>A button labeled "START".</li> </ul>

# Using Your Microwave Oven

## Microwave oven controls

There are three parts in the control section:

- Display/Clock and Indicators
- Command Pads
- Number Pads

Instructions for each control are covered on the following pages. Read them carefully.

When you first plug in the oven, the Display will flash “88:88”. Touch STOP/CANCEL and “1:00” will appear. If, after you set the Clock (page 11), the Display again shows all 8’s, it means your electricity was off for a while. Reset the Clock.

### Display/clock and indicators

When you are not using the microwave oven, this is an accurate clock.

When you are using the microwave oven, it displays time settings, cook powers, and Indicators.

### Command pads

- Touch Command Pads to tell the microwave oven what to do and in what order. A few examples:
  - CLOCK tells the oven you are going to set the clock.
  - START tells the oven to start.
- Each Command Pad (except START, STOP/CANCEL, CLOCK/AUTO START and TIMER/PAUSE) causes an Indicator to light when you touch the Command Pad. While the oven is running, an Indicator (or Indicators) will be on to show what the oven is doing.
- If you touch two instructions into the same cycle, the second set of instructions will cancel the first.

### Number pads

Once you’ve touched a Command Pad to tell the oven what you want it to do, you’ll touch Number Pads to tell it ...

- a time,
- a Cook Power,
- a Sensor Cook Setting.

### Display messages

Messages will appear on the display to guide you with your cooking. If you attempt to enter unacceptable instructions, “ERROR” will appear on the Display. Touch STOP/CANCEL and re-enter the instructions.

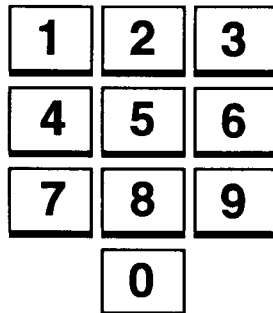

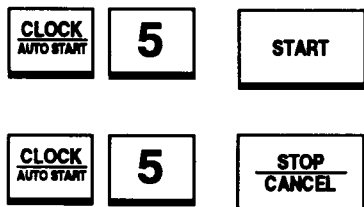

## Audible signals

Audible signals are available to guide you when setting and using your oven. A programming tone will sound each time you touch a pad. A single, long tone signals the end of cooking or Minute Timer function. If you do not hear a tone, it is because the audible signals have been removed or because of incorrectly entered instructions.

### To remove the audible signals:

1. Touch CLOCK/AUTO START.
2. Touch Number Pad 5.
3. Touch START.

### To replace the audible signals:

1. Touch CLOCK/AUTO START.
2. Touch Number Pad 5.
3. Touch STOP/CANCEL.

**NOTE:** If your electricity goes off, the audible signals will come back on. Repeat steps above if you want to remove them again.

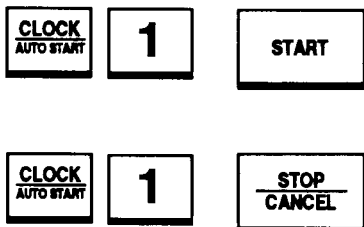

## Using the safety lock

The safety lock prevents unwanted operation of the microwave oven by small children.

### To lock or deactivate the control panel:

1. Touch CLOCK/AUTO START. Then touch Number Pad 1.
2. Touch START. "LOCK" will appear in the Display if a pad is touched.

### To cancel safety lock:

1. Touch CLOCK/AUTO START. Then touch Number Pad 1.
2. Touch STOP/CANCEL.

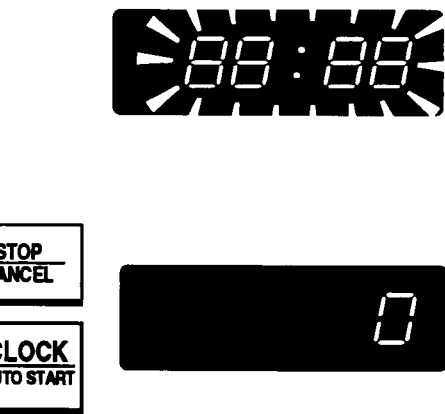

## Setting the clock

When the oven is first plugged in, the Display flashes "88:88". If the electric power ever goes off, the Display will again flash all 8's when the power comes back on.

You can cook without setting the clock, but the display will not show the correct time of day after cooking. To set the correct time of day, follow these steps:

1. Touch STOP/CLEAR and the Display will show "1:00". Then touch CLOCK/AUTO START and the Display will show "0".

## Using Your Microwave Oven Continued

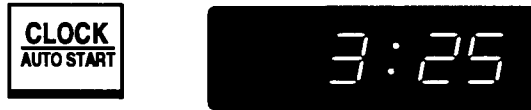

2. Touch Number Pads for the correct time of day. The Display will show what numbers you touched **in the order you touched them**. This example shows 25 minutes after 3 o'clock.

3. Touch CLOCK/AUTO START. The Clock is set.

If you have touched in an incorrect time, such as 12:65, "ERROR" will show on the Display. Touch STOP/CANCEL, then touch CLOCK/AUTO START and start over.

**NOTE:** To **reset** the clock, touch CLOCK/AUTO START. The current time will show on the Display. Continue to set the clock as shown above.

---

## Using the Minute Timer

Your microwave oven can be used as a kitchen timer. Use the Minute Timer for timing up to 99 minutes, 99 seconds.

1. Touch Number Pads for the minutes and seconds you want. The Display will show the numbers you touched **in the order you touched them**. This example shows 3 minutes.
2. Touch TIMER/PAUSE. The Display will count down to show you how much time is left. During the countdown the oven will be dark and the fan will be off.
3. When the set time ends, a long tone will sound. The Display will then show the time of day.

### NOTES:

- To see the time of day while the Minute Timer is counting down, touch CLOCK/AUTO START.
- If you want to use other Command Pads while the Minute Timer is counting down, touch STOP/CANCEL to cancel the Minute Timer.

---

## Using STOP/CANCEL

Touch STOP/CANCEL once to:

- Erase instructions if you make a mistake during programming.
- Cancel the Minute Timer.
- Stop the oven temporarily during cooking.

Touch STOP/CANCEL twice to:

- Cancel a program during cooking.

**NOTE:** The oven may also be stopped during a cycle by opening the door. Close the door and touch START to continue cooking.

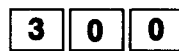

## Cooking in your microwave oven

Although a new rating method\* rates this oven at 800 watts, you may use a reliable cookbook and recipes developed for 700-watt microwave ovens.

### To get the best cooking results:

- ALWAYS cook food for the minimum recommended cooking time. If necessary, add time in one or two minute periods, then check for doneness to avoid overcooking the food.
- Stir, turn over or rearrange the food being cooked about halfway through the cooking time for most even doneness with all recipes.
- If a glass cover is not available, use wax paper, paper towels or microwave-approved plastic wrap. Turn back a corner to vent steam during cooking.

\*IEC-705 Test Procedure. The IEC-705 Test Procedure is an internationally recognized method of rating microwave wattage output and does not represent an actual change to output power or cooking performance.

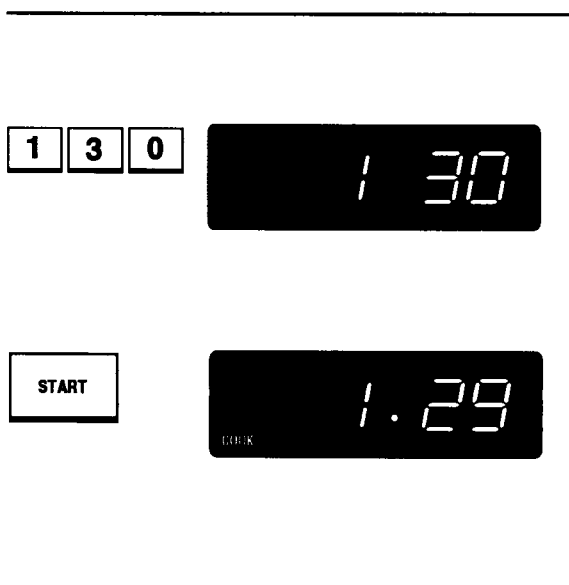

## Cooking at high cook power

Follow these steps to cook at **high power**:

1. Put food in the oven and close the door.
2. Touch Number Pads for the cooking time you want. The Display will show the numbers you touched **in the order you touched them**. The example shows 1 minute, 30 seconds.

**NOTE:** If programming more than one cycle, you must touch COOK POWER twice for full (100%) Cook Power. If programming only one cycle, you do not need to touch COOK POWER at all.

3. Touch START. The oven will automatically cook at high Cook Power. The COOK Indicator will come on to show that the oven is cooking. The Display counts down the time to show how much time is left in the cycle. When the cooking time ends, a long tone will sound. The Display will then show the time of day.

## Cooking at lower cook powers

For best results, some recipes call for lower Cook Powers. The lower the Cook Power, the slower the cooking. Each Number Pad also stands for a different percentage of Cook Power. Many microwave cookbook recipes tell you by number, percent or name which Cook Power to use.

## Using Your Microwave Oven Continued

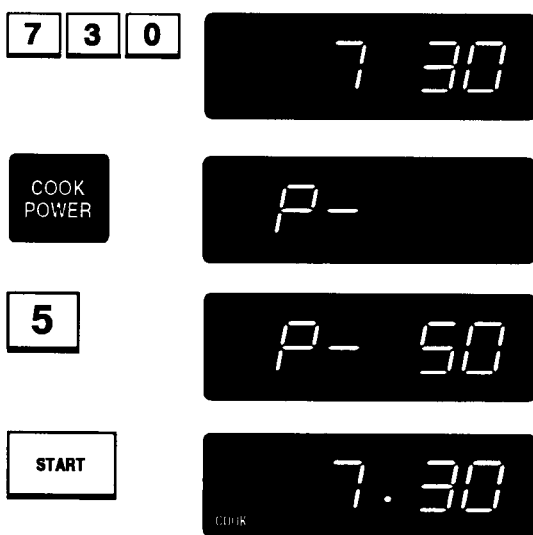

The following chart gives the percentage of Cook Power each Number Pad stands for, and Cook Power name usually used:

Automatic 100% of full power HIGH

9 = 90% of full power

8 = 80% of full power

7 = 70% of full power MED-HIGH

6 = 60% of full power

5 = 50% of full power MED

4 = 40% of full power

3 = 30% of full power MED-LOW

2 = 20% of full power

1 = 10% of full power LOW

0 = 0% of full power (fan and light will be on)

1. Put food in the oven and close the door.
2. Touch Number Pads for the cooking time you want. The Display will show the numbers you touched in the order you touched them. This example shows 7 minutes, 30 seconds.
3. Touch COOK POWER. The Display will show "P-".
4. Touch a Number Pad for the Cook Power you want. The Display will show what you touched. This example shows you touched Number Pad 5 for 50% of full power.
5. Touch START. The COOK Indicator will come on to show that the oven is cooking. The Display counts down the time to show how much cooking time is left in the cycle. When the cooking time ends, a long tone will sound and "End" will flash on the Display until the door is opened or you touch STOP/CANCEL. The Display will then show the time of day.

## Using CUSTOM DEFROST

Your microwave oven automatically defrosts a variety of common meats at preset cook powers for preset times. The 3-stage Custom Defrost Cycle is programmed for: Roast Beef, Pork; Steaks, Chops, Fish; Ground Meat; Chicken, Whole; and Chicken Pieces. All you do is touch the Number Pad assigned to the desired category and enter the weight of the items being heated. Your microwave oven does the rest.

1. Put frozen food in the oven and close the door.
2. Touch CUSTOM DEFROST. The DEFROST Indicator will come on and "FOOD" will flash on the Display.





3. Select a Custom Defrost setting by touching the appropriate Number Pad. The Display will show CD (Computerized Defrosting) for the setting you selected and the "LBS." Indicator will flash. This example shows an entry of "2" for Steaks, Chops, Fish.
4. Touch Number Pads to enter the food's weight. The weight will appear on the Display. This example shows an entry of "2.0" for two pounds.

**NOTE:** If "ERROR" appears on the Display, touch STOP/CANCEL and start over. See the Custom Defrost label, located behind door on oven frame, for weight ranges available for each food category.

5. Touch START. The COOK Indicator will come on to show that the oven is defrosting. The Display will count down the time to show how much defrosting time is left.
6. After the first stage is completed, the oven will stop, 4 tones will sound, and directions will appear on the Display. Open the door, turn meat over and shield any warm portions. (The Displays shown are just examples of directions you will see, depending on the type of meat being thawed.) Close the door. "PRESS START" will appear.
7. Touch START. The Display will continue to count down the second stage of the defrost cycle.
8. After the second stage is completed, the oven will stop, 4 tones will sound, and directions will appear on the Display. Open the door, shield any warm portions and close the door. "PRESS START" will appear.

9. Touch START to complete defrosting.
10. After defrosting, the oven will stop and directions will appear on the Display. Open the door or touch STOP/CANCEL. The Display will then show the time of day.

- NOTES:**
- If you enter an amount not shown on the Custom Defrost label, "ERROR" will appear on the Display. Custom Defrost will only operate within the weight ranges shown on the label. Round weights of food items to the nearest half pound.
  - To defrost items not listed on the Custom Defrost label, use 30% Cook Power. See a reliable cookbook for defrosting information.



## Cooking with more than one cook cycle

For best results, some recipes call for one Cook Power for a certain length of time, and another Cook Power for another length of time. Your oven can be set to change from one to another automatically.

1. Put food in the oven and close the door.
2. Touch Number Pads for the cooking time you want. The Display will show the numbers you touched in the order you touched them. This example shows 7 minutes, 30 seconds.
3. Select a Cook Power.
  - To cook at full (100%) power, touch COOK POWER twice. The Display will show "P-HI". This shows the oven is programmed to cook at full power.
  - To select another Cook Power, touch COOK POWER once, followed by a Number Pad for the Cook Power you want in the first cycle. This example shows you touched Number Pad 5 for 50% of full power.
4. Touch Number Pads for the cooking time you want in the second cycle. The Display will show the numbers you touched in the order you touched them. This example shows 3 minutes, 25 seconds.
5. Select a Cook Power.
  - To cook at full (100%) power, skip to Step 6.
  - To cook at another Cook Power, touch COOK POWER once followed by a Number Pad for the Cook Power you want in the second cycle. This example shows you touched Number Pad 6 for 60% of full power.

6. Touch START. The Cook Indicator will come on and the Display counts down the time to show how much cooking time is left in each cycle. When the cooking time ends, a long tone will sound. The Display will then show the time of day.

### Changing or adding instructions

You can change times, Cook Powers or add cycles any time before or after touching START:

1. Touch STOP/CANCEL twice.
2. Enter your new instructions.



## Using SENSOR COOK

(KCMS125Y only)

Cooking with SENSOR COOK takes the guesswork out of microwave cooking. The microwave oven automatically adjusts cooking times and powers by detecting the moisture and humidity emitted by the food as it heats.

1. Put food in oven and close the door.
2. Touch SENSOR COOK. The SENSOR Indicator will come on and "FOOD" will flash on the Display.
3. Select a Sensor Cook setting by touching the appropriate Number Pad. (See the Sensor Cook label located behind oven door on frame for setting information.) "SC" will show on the Display along with the setting you selected.  
**NOTE:** If you touch the wrong Sensor setting, touch the correct setting. The selected setting will appear on the Display.
4. Touch START. The COOK Indicator will come on to show that the oven is operating in the Sensor Cook cycle. The sensor now detects the moisture and humidity emitted by the food.  
**NOTE:** Do not open the door or touch STOP/CANCEL during this part of the cooking cycle. The measurement will be interrupted.  
 If "ERROR" appears on the Display before cooking starts, touch STOP/CANCEL and start over. If "ERROR" appears after cooking has started, touch STOP/CANCEL and continue cooking using a timed cycle. See page 13 or 14.
5. When the Display shows the remaining cooking time, the door can be opened and the food stirred or seasoned.

6. After cooking, the oven will stop and directions will appear on the Display. Open the door or touch STOP/CANCEL. The Display will then show the time of day.

SENSOR  
COOK



2

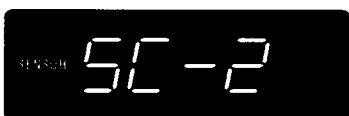

START

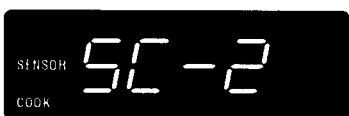

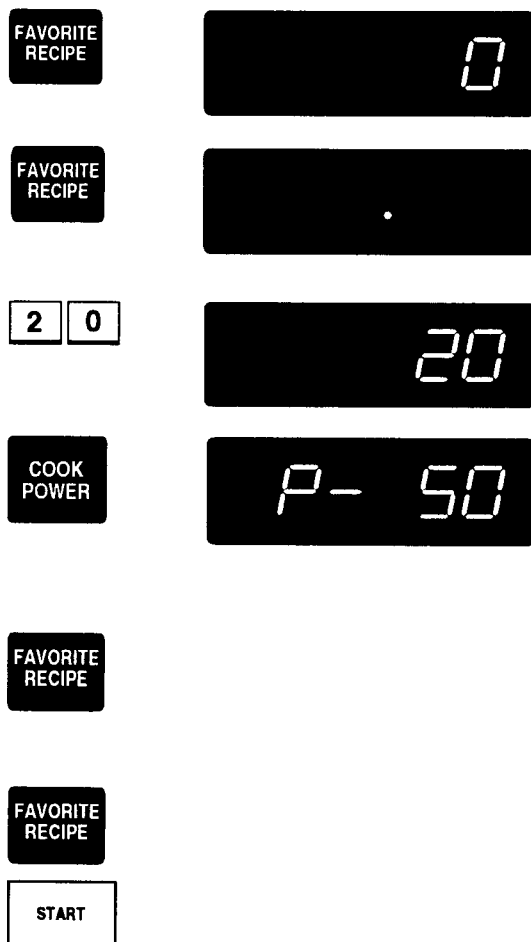

## Using FAVORITE RECIPE

(KCMS125Y only)

FAVORITE RECIPE allows you to recall one cooking instruction previously placed in memory and begin cooking quickly. For example, if you heat a roll every morning, program the cooking steps into FAVORITE RECIPE. You can heat your roll each morning by touching FAVORITE RECIPE.

### To program Favorite Recipe:

1. Touch FAVORITE RECIPE. The Display will show "0".
2. Touch FAVORITE RECIPE again. The Display will show ".".
3. Touch the Number Pads for the cooking time desired. This example shows an entry of 20 seconds.
4. Select a Cook Power.
  - To cook at full (100%) power, skip to Step 5.
  - To cook at another Cook Power, touch COOK POWER once followed by a Number Pad for the Cook Power desired. This example shows an entry of "5" for 50% Cook Power.
5. Touch FAVORITE RECIPE. FAVORITE RECIPE is now programmed.

### To use Favorite Recipe:

1. Put food in oven and close the door.
2. Touch FAVORITE RECIPE.
3. Touch START. The oven will cook according to your programmed instructions. When cooking ends, a long tone will sound. The Display will then show the time of day.

**NOTE:** You can reprogram FAVORITE RECIPE by repeating the instructions above. Also, a power failure will erase your Favorite Recipe program. It will have to be reprogrammed.



## Using EASY MINUTE

EASY MINUTE allows you to add an extra minute to your cooking cycle. You can also use it to extend cooking time in multiples of one minute.

1. Make sure food is in the oven.
2. Touch EASY MINUTE.
3. To extend cooking time in multiples of one minute, touch EASY MINUTE repeatedly during cooking. When the cooking time ends, a long tone will sound. The Display will then show the time of day.

### NOTES:

- EASY MINUTE can only be entered after closing the door, after touching STOP/CANCEL, during cooking, or within one minute after cooking with another function.
- If you touch EASY MINUTE during cooking, the oven will cook at the currently selected Cook Power. If you touch EASY MINUTE after cooking, the oven will cook at 100% Cook Power.

EASY MINUTE cannot be set:

- with FAVORITE RECIPE, AUTO START, SENSOR COOK or CUSTOM DEFROST.
- to start the oven if any program is on the Display.
- if the oven door is open.

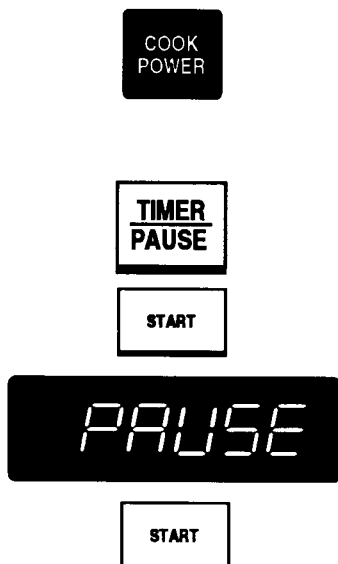

## Using PAUSE

PAUSE allows you to stop the oven between cooking cycles to stir, turn food over or add ingredients during the cooking process.

1. Put food in the oven and close the door.
2. Touch in instructions for the first cooking cycle. (See pages 13-14.)
3. Touch COOK POWER twice for full (100%) Cook Power or touch COOK POWER once followed by a Number Pad for the Cook Power you want in the first cycle.  
**NOTE:** The COOK POWER Command Pad must be touched between cycles.
4. Touch TIMER/PAUSE.
5. Touch in instructions for the second cooking cycle. (See pages 13-14.)
6. Touch START. The Display will count down the time in the first cycle.
7. When the first cycle is over, 4 tones will sound and "PAUSE" will show on the Display. Open the door and stir the food. Close the door and touch START for the second cooking cycle. When the cooking time ends, a long tone will sound. The Display will then show the time of day.

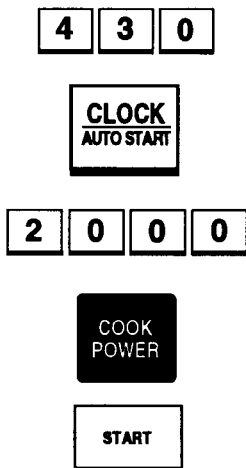

## Using AUTO START

AUTO START lets you program your oven to begin cooking automatically at a designated time of day. You can touch in up to 99 minutes, 99 seconds of delay.

1. Put in food and close the door.
2. Make sure the clock is set to the correct time of day.
3. Touch Number Pads to enter the desired start time. This example shows a 4:30 start time.
4. Touch CLOCK/AUTO START.
5. Touch Number Pads to enter the amount of cooking time you want.
6. Touch COOK POWER twice to cook at full (100%) power or touch COOK POWER once followed by a Number Pad for the Cook Power you want.
7. Touch START. The oven will start at the time you set and the Display will count down the cooking time you have selected.

8. When the cooking time ends, a long tone will sound. The Display will then show the time of day.

**NOTE:** If you hear the fan start when you touch START, you have not set the oven properly. Touch STOP/CANCEL twice and start over.

AUTO START cannot be used with EASY MINUTE or CUSTOM DEFROST.

### **⚠ WARNING**

To avoid sickness and food waste when using AUTO START:

- Do not use foods that will spoil while waiting for cooking to start, such as dishes with milk or eggs, cream soups, and cooked meats or fish. Any food that has to wait for cooking to start should be very cold or frozen before it is put in the oven. **MOST UNFROZEN FOODS SHOULD NEVER STAND MORE THAN TWO HOURS BEFORE COOKING STARTS.**
- Do not use foods containing baking powder or yeast when using AUTO START. They will not rise properly.
- Do not allow food to remain in oven for more than two hours after end of cooking cycle.

## Microwave cooking chart

<b>MEATS, POULTRY, FISH, SEAFOOD</b>			<b>REHEATING</b>		
Allow standing time after cooking.			Food should be very hot (165°F). Stir before serving, if possible.		
FOOD	COOK POWER	TIME	FOOD	COOK POWER	TIME
<b>Bacon</b>	100%	45 sec to 1 min 15 sec/slice	<b>Meat Slices</b>	50%	1-3 min/serving
<b>Ground Beef for Casseroles (1 lb)</b>	100%	4-6 min	<b>Non-Stirrable Casseroles (1 serving)</b>	50%	5-8 min
<b>Hamburger Patties (2)</b>	100%	1st side 2 min 2nd side 1½ to 2½ min	<b>(2 servings)</b>		9-12 min
<b>Hamburger Patties (4)</b>	100%	1st side 2½ min 2nd side 2-3 min	<b>Pie (1 slice)</b>	100%	20-40 seconds
<b>Meat Loaf (1½ lbs)</b>	100%	13-19 min	<b>Soup (1 serving)</b>	100%	2½-3½ min
<b>Chicken Pieces</b>	100%	6-9 min/lb	<b>(2 servings)</b>		4½-5½ min
Internal temperature should be 185°F after standing.			<b>Vegetables (1 serving)</b>	100%	¾-1½ min
<b>Turkey Breast</b>	100% then 70%	5 min 8-12 min/lb	<b>(2 servings)</b>		1½-2½ min
Internal temperature should be 185°F after standing.			<b>OTHER</b>		
<b>Fish Fillets (1 lb)</b>	100%	5-6 min	FOOD	COOK POWER	TIME
<b>Scallops and Shrimp (1 lb)</b>	100%	3½-5½ min	<b>Applesauce (4 servings)</b>	100%	7-10 min
<b>VEGETABLES</b>			<b>Baked Apples (4)</b>	100%	4-6 min
Cook at 100% Cook Power.			<b>Chocolate (melt 1 square)</b>	50%	1-2 min
FOOD		TIME	<b>Eggs, Scrambled (2)</b>	100%	1 min 15 sec to 1 min 45 sec
<b>Beans, Green or Yellow (1 lb)</b>		6-12 min	<b>(4)</b>		2-3 min
<b>Broccoli (1 lb)</b>		6-10 min	<b>Hot Cereals (1 serving)</b>	100%	1½-5 min
<b>Carrots (1 lb)</b>		8-12 min	<b>(4 servings)</b>		4½-7 min
<b>Cauliflower (medium head)</b>		6-9 min	<b>Nachos (large plate)</b>	50%	1½-2½ min
<b>Corn on the Cob (2)</b>		4-9 min	<b>Water for Beverage (1 cup)</b>	100%	2½-4 min
<b>(4)</b>		6-16 min	<b>(2 cups)</b>		4½-6 min
<b>Potatoes, Baked (4 medium)</b>		13-19 min			
<b>Squash, Summer (1 lb)</b>		3-8 min			

# Installation Instructions

Before you begin operating the oven, carefully read the following instructions.

## Installing your microwave oven

1. Empty the microwave oven and clean inside it with a soft, damp cloth. Check for damage such as misaligned door, damage around the door or dents inside the oven or on the exterior. If there is any damage, do not operate the unit until it has been checked by an authorized KitchenAid service technician and any repairs made.
2. Put the oven on a cart, counter, table or shelf that is strong enough to hold the oven and the food and utensils you put in it. **(The control side of the unit is the heavy side. Use care when handling.)** The weight of the oven is approximately 35 lbs (15.75 kg).

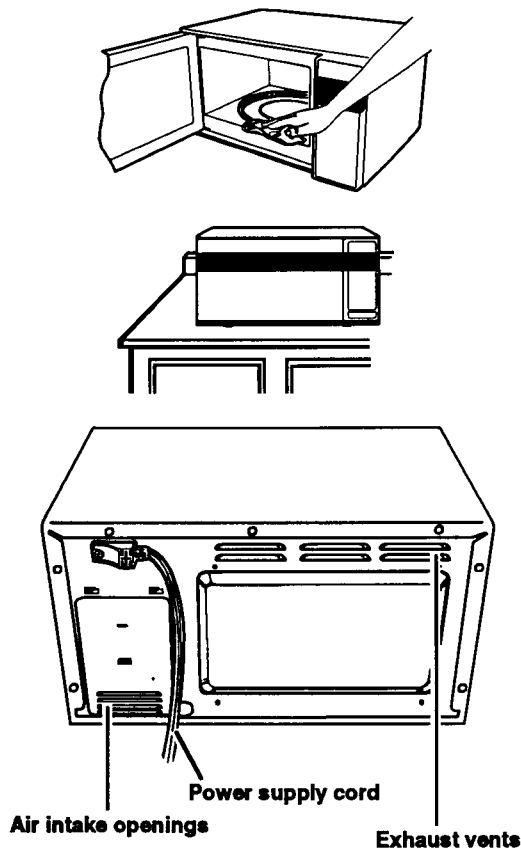

### **⚠ WARNING**

**Fire, Electrical Shock, Excessive Exposure To Microwave Energy, Personal Injury and Product Damage Hazard**

- Do not block the rear air intake openings or exhaust vents. Allow a few inches of space at back of oven where vents and intake openings are located. Blocking the air intake openings and exhaust vents can cause damage to the oven and poor cooking results. Make sure the microwave oven legs are in place to ensure proper airflow.
- Do not install the oven next to or over a heat source (for example, a cooktop or range) without a UL approved trim kit or without being in a UL approved built-in configuration. Also, do not install oven in any area where excessive heat and steam are generated. This could cause a fire, electrical shock, excessive exposure to microwave energy, other personal injury or damage to the outside of the cabinet.

#### **Built-in kits**

You can build in your microwave oven by using one of the trim kits listed on page 5.

These kits are available from your KitchenAid Dealer. If your dealer does not stock the kit, it can be ordered by writing to:

KitchenAid  
Parts Distribution Center  
123 Koomler Drive  
LaPorte, IN 46350

### 3. Electrical requirements

Observe all governing codes and ordinances. A 120 Volt, 60 Hz, AC only, 20 amp fused electrical supply is required. (Time-delay fuse is

recommended.) It is recommended that a separate circuit serving only this appliance be provided.

## 4. GROUNDING INSTRUCTIONS

### **⚠ WARNING**

#### Electrical Shock Hazard

**Improper use of the grounding plug can result in a risk of electrical shock. DO NOT, UNDER ANY CIRCUMSTANCES, REMOVE THE POWER SUPPLY CORD GROUNDING PRONG.**

5. For your personal safety, this appliance must be grounded. In the event of an electrical short circuit, grounding reduces the risk of electrical shock by providing an escape wire for the electric current. This appliance is equipped with a polarized 3-prong grounding plug. It must be plugged into a correctly polarized mating 3-prong grounding type wall receptacle, properly installed and grounded in accordance with the National Electrical Code and local codes and ordinances. If a mating wall receptacle is not available or if you are not sure if the wall receptacle is properly grounded and polarized, have it checked by a qualified electrician.

It is the personal responsibility and obligation of the customer to have a properly grounded and correctly polarized 3-prong wall receptacle installed by a qualified electrician.

Consult a qualified electrician if the grounding instructions are not completely understood, or if doubt exists as to whether the appliance is properly grounded.

**It is not recommended to use an extension cord with your microwave oven, but if you find it necessary to do so temporarily (until a properly grounded and polarized 3-prong receptacle is installed), use only a heavy duty UL listed 3-wire grounding type extension cord containing three 16-gauge (minimum) copper wires.** It must not be longer than 10 feet (cords longer than 10 feet may affect the cooking performance of your microwave oven). The plug on the extension cord must fit into a 3-prong grounding type wall receptacle (as shown on this page) and the receptacle end of the extension cord must accept the 3-prong grounding plug of the microwave oven.

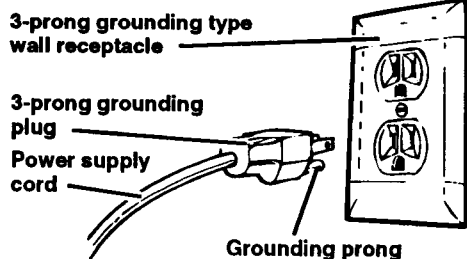

6.  To test the oven, plug it into the proper electrical outlet. Put about one cup (250 mL) of cold water in a glass container in the oven. Close the door. Make sure it latches. Follow the directions on page 13 to set the oven to cook for 2 minutes. When the time is up, the water should be heated.

7. **This microwave oven is designed for use in the household only and must not be used for commercial purposes.**

**Do not remove the door, control panel or cabinet at any time. The unit is equipped with high voltage and should be serviced by an authorized KitchenAid service technician.**

**- SAVE THESE INSTRUCTIONS -**

# Caring For Your Microwave Oven

## Cleaning the microwave oven

Wipe often with warm, sudsy water and a sponge or paper towel. The glass turntable may be removed for cleaning; however, this oven is designed to operate with the turntable in place. Do not operate the microwave oven when turntable is removed for cleaning. See page 28 for further information about the turntable.

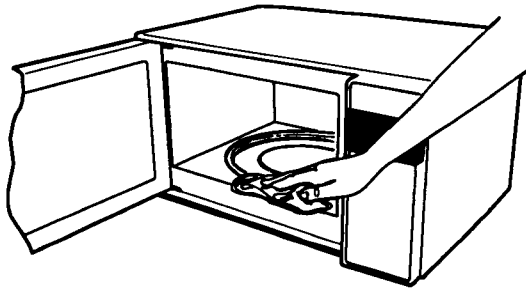

For stubborn soil, boil a cup of water in the oven for 2 or 3 minutes. Steam will soften the soil.

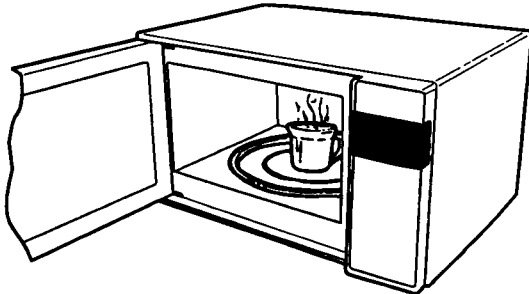

Be sure to keep the areas clean where the door and oven frame touch when closed. Use only mild, nonabrasive soaps or detergents applied with a sponge or paper towel when cleaning surfaces. Rinse well.

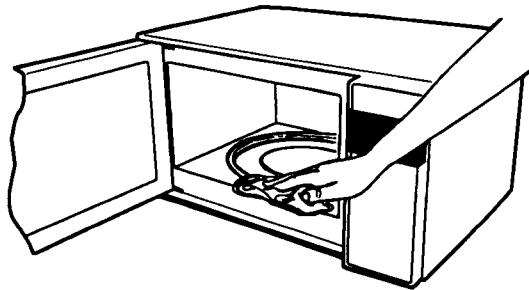

### ⚠ CAUTION

#### Product Damage Hazard

Abrasive cleansers, steel-wool pads, gritty wash cloths, etc., can damage the control panel and interior and exterior oven surfaces. Use a sponge with a mild detergent or a paper towel with spray glass cleaner. Apply spray glass cleaner to paper towel; do not spray directly on oven.

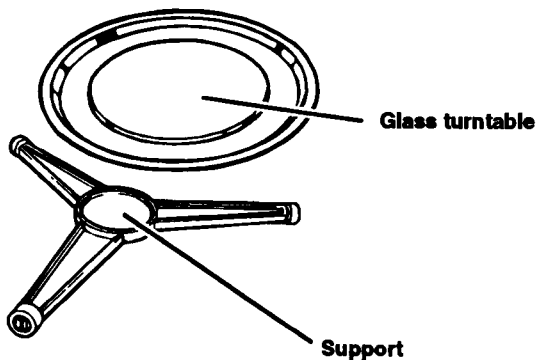

To clean turntable and support, wash in mild, sudsy water; for heavily soiled areas use a mild cleanser and scouring sponge. The turntable and turntable support are dishwasher-safe.



# How Your Microwave Oven Works

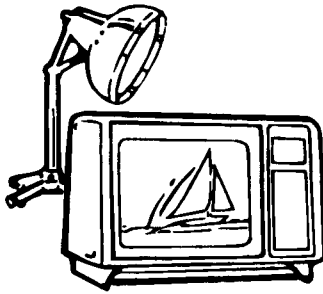

Microwave ovens are safe. Microwave energy is not hot. It causes food to make its own heat, and it's this heat that cooks the food.

Microwaves are like TV waves or light waves. You cannot see them, but you can see what they do.

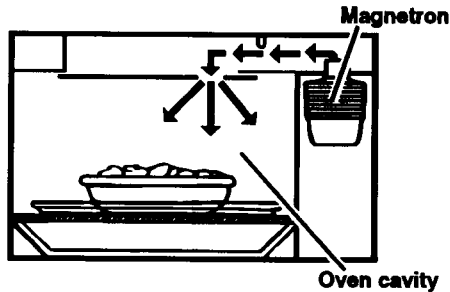

A magnetron in the microwave oven produces microwaves. The microwaves move into the oven where they contact food as it turns on the glass turntable.

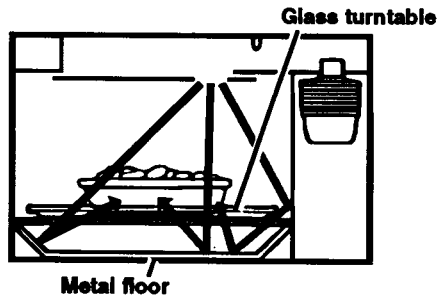

The glass turntable of your microwave oven lets microwaves pass through. Then they bounce off a metal floor, back through the glass turntable, and are absorbed by the food.

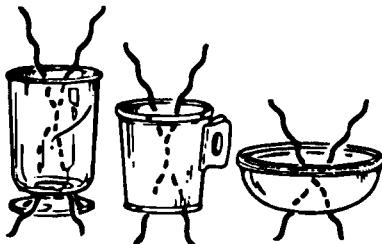

Microwaves pass through most glass, paper and plastics without heating them so food absorbs the energy. Microwaves bounce off metal pans so food does not absorb the energy.

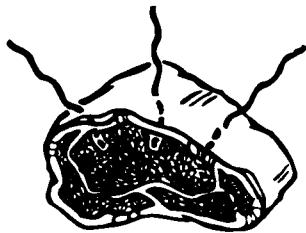

Microwaves may not reach the center of a roast. The heat spreads to the center from the outer, cooked areas just as in conventional cooking. This is one of the reasons for letting some foods (for example, roasts or baked potatoes) stand for a while after cooking, or for stirring some foods during the cooking time.

The microwaves disturb water molecules in the food. As the molecules bounce around bumping into each other, heat is made, like rubbing your hands together. This is the heat that does the cooking.

# Operating Safety Precautions

## **⚠ WARNING**

To reduce the risk of burns, fire, electrical shock, injury to persons, or damage when using the microwave oven, follow the precautions on pages 26-29.



**Never cook or reheat a whole egg.** Steam build-up in whole eggs may cause them to burst and burn you, and possibly damage the oven. Slice hard-boiled eggs before heating. In rare instances, poached eggs have been known to explode. Cover poached eggs and allow a standing time of one minute before cutting into them.



**Stir before heating**

**For best results, stir any liquid several times before heating or reheating.** Liquids heated in certain containers (especially cylindrical-shaped containers) may become overheated. The liquid may splash out with a loud noise during or after heating or when adding ingredients (coffee, etc.) resulting in harm to the oven and possible personal injury.



**Never lean on the door or allow a child to swing on it when the door is open.** Injury could result.

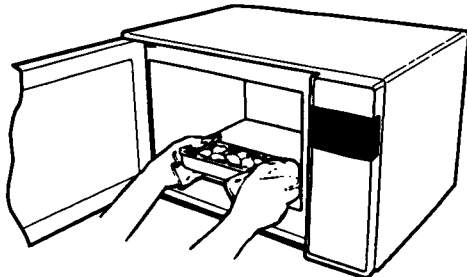

**Use hot pads.** Microwave energy does not heat containers, but the hot food does.

**Do not do canning of foods in the oven.** Closed glass jars may explode resulting in damage to the oven or possible personal injury.

**Do not use the oven to sterilize objects** (baby bottles, etc.). It is difficult to maintain the high temperature required for safe sterilization.

**Do not deep fry in the oven.** Microwavable utensils are not suitable and it is difficult to maintain appropriate deep frying temperatures.

**Do not use the oven for storage.** Do not leave anything in the oven when not in use. Fire may result if someone accidentally starts the oven.

**Do not let food or container touch the top or sides of the oven.**

**Do not heat, store or use flammable materials in or near the oven.** Fumes can create a fire hazard or explosion.

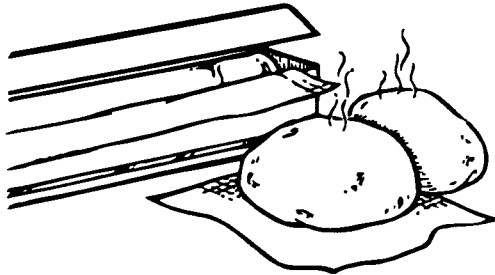
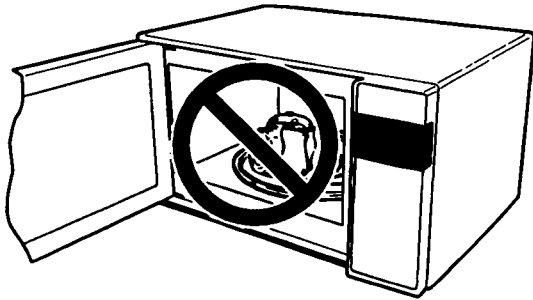

**Do not overcook potatoes.** Fire could result. At the end of the recommended cooking time potatoes should be slightly firm because they will continue cooking during standing time. After microwaving, wrap potatoes in foil and set aside for 5 minutes. They will finish cooking while standing.

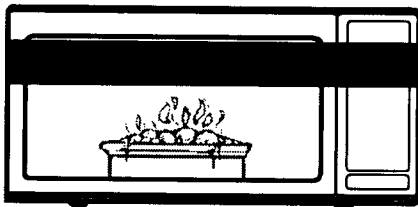

If a fire should start in the oven cavity:

- **Do not open the oven door.**
- **Touch STOP/CANCEL to turn oven off.**
- **Unplug the oven or turn off the power at the main power supply.**

**Operating Safety Precautions  
Continued**

**Do not pop popcorn, except in a microwave-approved popcorn popper or commercial package designed especially for microwave ovens.**

**Never try to pop popcorn in a paper bag not designed for microwave oven use. Overcooking may result in smoke and fire.**

**Do not repop unpopped kernels.**

**Do not reuse popcorn bags.**

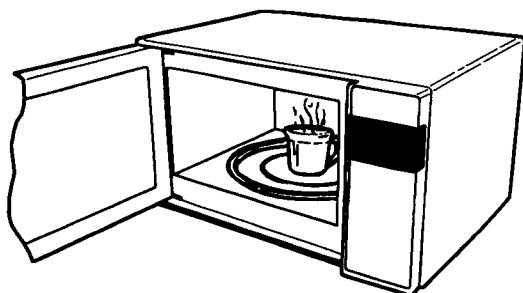

**Starting a microwave oven when it is empty is not recommended. Product life may be shortened.**

**If you practice programming the oven, put a container of water in the oven.**

**It is normal for the oven door to look wavy after the oven has been running for a while.**

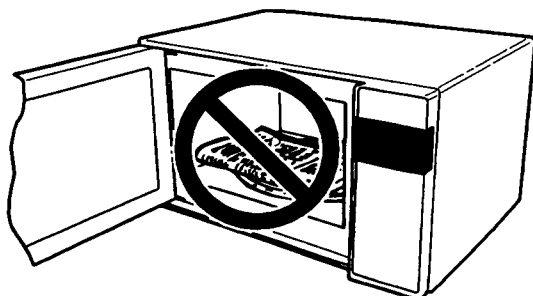

**Do not use newspaper or other printed paper in the oven. Fire could result.**

**Do not dry flowers, fruit, herbs, wood, paper, gourds or clothes in the oven. Fire could result.**

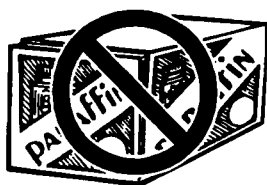

**Do not try to melt paraffin wax in the oven.**

**Paraffin wax will not melt in a microwave oven because it allows microwaves to pass through it.**

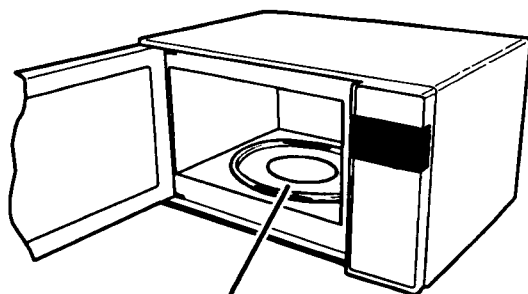

**Glass turntable**

**Do not operate the microwave oven unless the glass turntable is securely in place and can rotate freely. The turntable can rotate in either direction.**

**Make sure the glass turntable is correct-side up in oven. Carefully place cookware on glass turntable to avoid possible breakage.**

**Handle glass turntable with care when removing from oven to avoid possible breakage. If glass turntable cracks or breaks, contact your KitchenAid dealer for a replacement.**

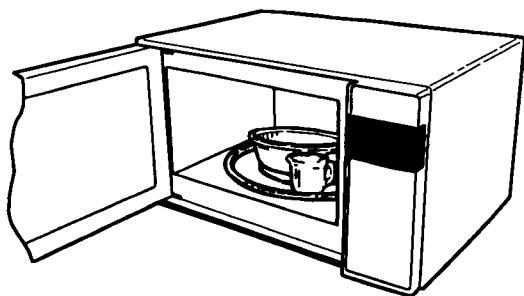
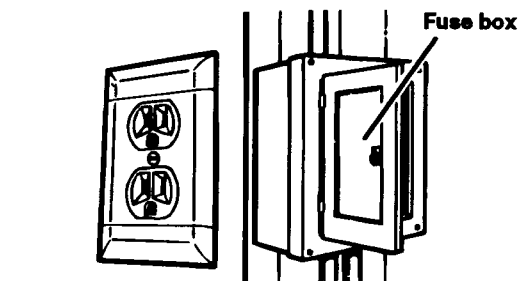

## General information

If your electric power line or outlet voltage is less than 110 volts, cooking times may be longer. Have a qualified electrician check your electrical system.

**To test a dish for safe use**, put it into the oven with a cup of water **beside it**. Cook at 100% Cook Power for one minute. **If the dish gets hot and water stays cool, do not use it.** Some dishes (melamine, some ceramic dinnerware, etc.) absorb microwave energy, becoming too hot to handle and slowing cooking times.

### **⚠ CAUTION**

#### **Product Damage Hazard**

**Remove wire twist-ties from paper or plastic bags before placing bag in oven. Cooking in metal containers not designed for microwave use can damage the oven, as can containers with hidden metal (twist-ties, foil lining, staples, metallic glaze or trim).**

# Questions And Answers

QUESTIONS	ANSWERS
Can I operate my microwave oven without the turntable or turn the turntable over to accommodate a large dish?	No. If you remove or turn over the turntable, you will get poor cooking results. Dishes used in your oven must fit on the turntable.
Can I use a rack in my microwave oven so that I may reheat or cook on two levels at a time?	You can use a rack only if rack is supplied with your microwave oven. Use of any rack not supplied with the microwave oven can result in poor cooking performance and/or arcing.
Can I use either metal or aluminum pans in my microwave oven?	Useable metal includes aluminum foil for shielding, (use small, flat pieces), small skewers and shallow foil trays (if tray is 3/4 inch deep and filled with food to absorb microwave energy). Never allow metal to touch walls or door.
Is it normal for the turntable to turn in either direction?	Yes. The turntable rotates clockwise or counter-clockwise, depending on the rotation of the motor when the cooking cycle begins.
Sometimes the door of my microwave oven appears wavy. Is this normal?	This appearance is normal and does not affect the operation of your oven.
What are the humming noises that I hear when my microwave oven is operating?	You hear the sound of the transformer when the magnetron tube cycles on.
Why does the dish become hot when I microwave food in it? I thought that this should not happen.	As the food becomes hot it will conduct the heat to the dish. Be prepared to use hot pads to remove food after cooking.
What does "standing time" mean?	"Standing time" means that food should be taken out of the oven and covered for additional time after cooking. This process allows the cooking to finish, saves energy and frees the oven for another purpose.
Can I pop popcorn in my microwave oven? How do I get the best results?	Yes. Pop packaged microwave popcorn following manufacturer's guidelines. Do not use regular paper bags. Use the "listening test" by stopping the oven as soon as the popping slows to a "pop" every one or two seconds. Do not try to repop unpopped kernels. You can also use special microwave poppers. When using a popper, be sure to follow manufacturer's directions. Do not pop popcorn in glass utensils.

# If You Need Service Or Assistance ...

## We suggest you follow these steps:

### 1. Before calling for assistance ...

Performance problems often result from little things you can find and fix without tools of any kind.

#### If nothing operates:

- Is the power supply cord plugged into a live circuit with the proper voltage? (See pages 23 and 29.)
- Have you checked your home's main fuses or circuit breaker box?
- Have you checked the electric company for a power failure?

#### If the microwave oven will not run:

- Is the oven being used as a timer?
- Is the door firmly closed and latched?
- Did you touch START?
- Did you follow the directions exactly?
- Did you touch STOP/CANCEL twice to cancel previous programming?

#### If the microwave cooking times seem too long:

- Is the electric supply to your home or wall outlets low or lower than normal? Your electric company can tell you if the line voltage is low. Your electrician or service technician can tell you if the outlet voltage is low.
- Is the Cook Power at the recommended setting?
- Are you allowing for more time when cooking more food at one time?

#### If the Display shows a time counting down but the oven is not cooking:

- Have you set the controls as a kitchen timer?

#### If you do not hear the Programming Tone:

- Is the command correct?

#### If the fan seems to be running slower than usual:

- Has the oven been stored in a cold area? The fan will run slower until the oven warms up to normal room temperature.

If there has been a power interruption, the Display will flash "88:88". Reset the clock. (See page 11.)

### 2. If the problem is not due to one of the above items:\*

- Call KitchenAid Consumer Assistance Center, TOLL-FREE:  
**1-800-422-1230**  
and talk with one of our trained consultants. The consultant can instruct you in how to obtain satisfactory service from your appliance or, if service is necessary, recommend a qualified service company in your area.
- If you prefer, write to:  
Consumer Assistance Center  
KitchenAid  
P.O. Box 558  
St. Joseph, MI 49085-0558  
Please include a daytime phone number in your correspondence.

### 3. If you need service:\*

- Call your dealer or the repair service he recommends.
- All service should be handled locally by the dealer from whom you purchased the unit or an authorized KitchenAid servicer.
- If you are unable to obtain the name of a local authorized KitchenAid servicer, call our service assistance number (see Step 2).
- 4. If you are not satisfied with the action taken:\*
- Contact the Major Appliance Consumer Action Panel (MACAP). MACAP is a group of independent consumer experts that voices consumer views at the highest levels of the major appliance industry.
- Contact MACAP only when the dealer, authorized service and KitchenAid have failed to resolve your problem.  
Major Appliance Consumer Action Panel  
20 North Wacker Drive  
Chicago, IL 60606
- MACAP will in turn inform us of your action.

\*When requesting assistance, please provide: Model Number, Serial Number, Date of Purchase and a complete description of the problem. This information is needed to respond properly to your request.

# KitchenAid<sup>®</sup>

## *Countertop Microwave Oven Warranty*

LENGTH OF WARRANTY:	KITCHENAID WILL PAY FOR:	KITCHENAID WILL NOT PAY FOR:
<b>ONE YEAR FULL WARRANTY FROM DATE OF PURCHASE.</b>	Replacement parts and repair labor costs to correct defects in materials or workmanship. Service must be provided by an authorized KitchenAid servicing outlet.	<b>A. Service calls to:</b> <ol style="list-style-type: none"> <li>1. Correct the installation of the oven.</li> <li>2. Instruct you how to use the oven.</li> <li>3. Replace house fuses or correct house wiring.</li> </ol> <b>B. Repairs when oven is used in other than normal home use.</b>
<b>SECOND THROUGH FIFTH YEAR LIMITED WARRANTY FROM DATE OF PURCHASE.</b>	Replacement magnetron tube to correct defects in materials or workmanship.	<b>C. Damage resulting from accident, alteration, misuse, abuse, improper installation or installation not in accordance with local electrical codes.</b> <b>D. Any labor costs during the limited warranties.</b> <b>E. Replacement parts or repair labor costs for units operated outside the United States.</b> <b>F. Pickup and delivery. This product is designed to be repaired in the home.</b> <b>G. Repairs to parts or systems caused by unauthorized modifications made to the appliance.</b>

5/93

**KITCHENAID DOES NOT ASSUME ANY RESPONSIBILITY FOR INCIDENTAL OR CONSEQUENTIAL DAMAGES.** Some states do not allow the exclusion or limitation of incidental or consequential damages, so this exclusion or limitation may not apply to you.

This warranty gives you specific legal rights and you may also have other rights which vary from state to state.

If you need service, first see the "Service or Assistance" section of this book. After checking "Service or Assistance," additional help can be found by calling our Consumer Assistance Center telephone number, 1-800-422-1230, from anywhere in the U.S.A.

KitchenAid  
St. Joseph, Michigan, U.S.A. 49085



Printed on recycled paper—  
10% post consumer waste  
50% recovered materials