

GB

English,1

**SY10**  
**SY10X**  
**SY51**  
**SY51X**  
**SY56**  
**SY56X**

## Contents

### Installation, 2

Positioning

### Electrical connection, 3

Data plate

### Description of the appliance, 4

Overall view

Control panel

### Start-up and use, 5

Starting the oven

How to use the timer

### The electronic cooking programmer, 6

### Cooking modes, 7-8

Cooking modes

Practical cooking advice

Cooking advice table

### Precautions and tips, 9-10

General safety

Disposal

Respecting and conserving the environment

Recycling & Disposal Information

### Maintenance and care, 10

Switching the appliance off

Cleaning the appliance

Cleaning the oven door

Replacing the light bulb

### After Sales Service, 11

### Guarantee, 12

GB

# Installation

GB

! Before you operate your new Hotpoint Single Oven, please read these instructions fully. They contain important information for safe use, for installation and for care of the appliance.

! Please keep these operating instructions for future reference. Pass them on to possible new owners of the appliance.

! Keep packaging material out of the reach of children. It can become a choking or suffocation hazard. *see Precautions and tips*).

## Positioning

! The appliance must be installed by a qualified person in compliance with the instructions provided. Incorrect installation may cause harm to persons, animals or may damage property.

## Fitting the appliance

Use the appropriate cabinet to ensure that the appliance functions properly.

- The panels adjacent to the oven must be made of heat-resistant material.
- Cabinets with a veneer exterior must be assembled with glues which can withstand temperatures of up to 100°C.
- To install the oven **under the counter** (*see diagram*) and in a **kitchen unit**, the cabinet must have the following dimensions:

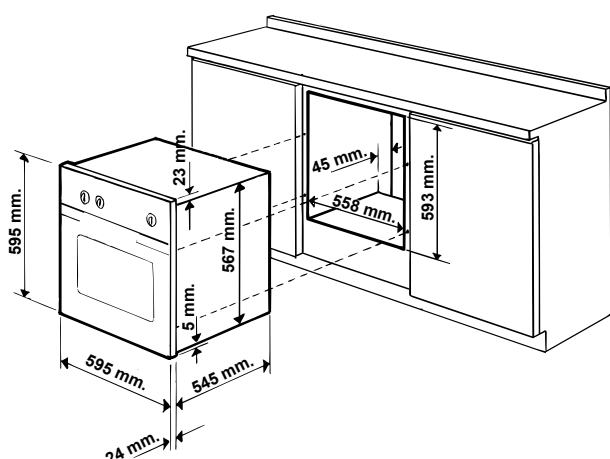

! The appliance must not come into contact with electrical parts once it has been installed. The consumption indications on the data plate have been calculated for this type of installation.

## Ventilation

To ensure good ventilation, the back panel of the cabinet must be removed. It is advisable to install the oven so that it rests on two strips of wood, or on a completely flat surface with an opening of at least 45 x 560 mm (*see diagrams*).

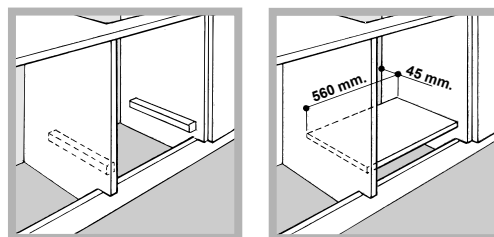

## Centring and fastening

Position the 4 tabs on the side of the oven according to the 4 holes of the outer frame. Adjust the tabs according to the thickness of the cabinet side panel, as shown below:

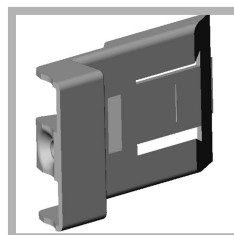

thickness of 20 mm: take off the removable part of the tab (*see diagram*)

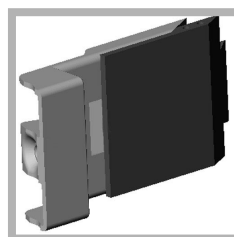

thickness of 18 mm: use the first groove, which has already been set in the factory (*see diagram*)

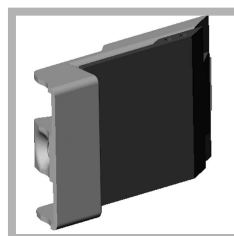

thickness of 16 mm: use the second groove (*see diagram*)

Secure the appliance to the cabinet by opening the oven door and putting 4 screws into the 4 holes of the outer frame.

! All parts which ensure the safe operation of the appliance must not be removable without the aid of a tool.

## Electrical connection

The electrical connection to the mains must be made on the appliance. The power voltage and frequency are as indicated on the rating plate.

**! THIS APPLIANCE MUST BE EARTHED.**

### Connecting the power supply cable

To open the terminal board:

- Using a screwdriver, press on the tabs situated on each side of the terminal board cover.
- Pull open the terminal board cover.

To connect the power supply cable, proceed as follows:

- Unscrew the cable clamp screw and the contact screws L-N-⊕.
- Fasten the wires beneath the screwheads using the following colour scheme: **Blue** (N) **Brown** (L) **Yellow-Green** ⊕
- Fasten the power supply cable in the corresponding cable clamp and close the cover.

### Electrical Connection:

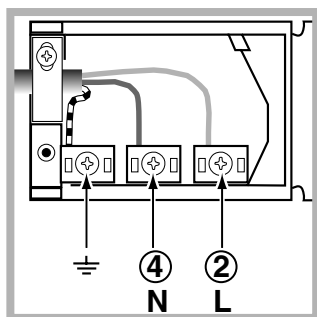

Voltage Frequency: 230 V-1+N 50Hz  
 Fuse Section: 16A  
 Supply cable: 3x1.5mm<sup>2</sup>

You can connect your oven to the system means of a terminal board. Refer to above information for the minimal cable sections and the calibration of the protective elements according to the connection. If the appliance is installed **with a junction box**, an **omnipolar circuit breaker** - with a minimum contact opening of 3mm - should be installed between the appliance and the mains.



### Power cable supply connection to the electrical mains:

We recommend you use a power supply cable which is long enough to allow you to take the oven out of its recess in the event of maintenance operations (only use HAR - H 05 - RRF quality cables fitted with a plug conforming to the regulations in force. The plug must be accessible at all times.

**Unplug the appliance before all operations, even when replacing the oven lamp.**

**Using the appliance without correct earthing is highly dangerous.**

**! After connecting the appliance to the flexible cable, tighten all the screws on the terminal board.**

DATA PLATE	
<b>Dimensions</b>	width cm 43.5 height cm 32 depth cm 41.5
<b>Volume</b>	lt. 58
<b>Electrical connections</b>	voltage: 230-240V ~ 50/60 Hz or 50Hz (see data plate) maximum power absorbed 2250-2400W
<b>ENERGY LABEL</b>	Directive 2002/40/EC on the label of electric ovens. Standard EN 50304 Energy consumption for Natural convection – heating mode: <input type="checkbox"/> Convection mode  Declared energy consumption for Forced convection Class – heating mode: <input checked="" type="checkbox"/> Multi-cooking
 	This appliance conforms to the following European Economic Community directives: - 73/23/EEC of 19/02/73 (Low Voltage) and subsequent amendments; - 89/336/EEC of 03/05/89 (Electromagnetic Compatibility) and subsequent amendments; - 93/68/EEC of 22/07/93 and subsequent amendments. - 2002/96/EC

# Description of the appliance

GB

## Overall view

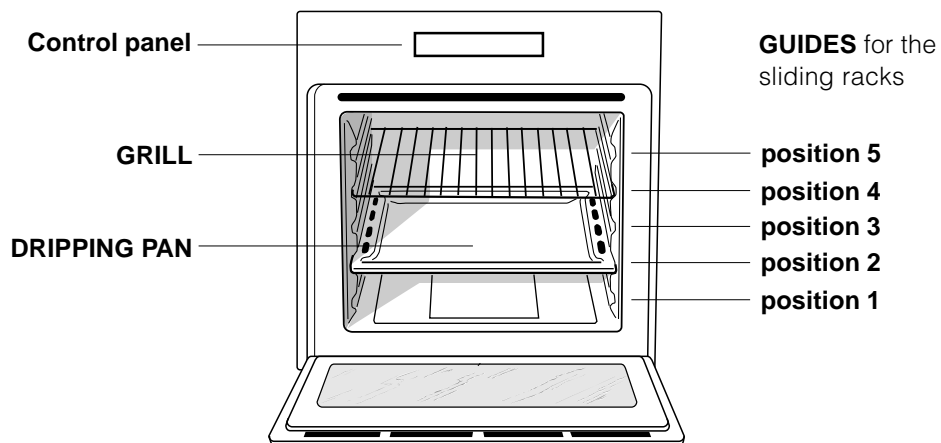

## Control panel

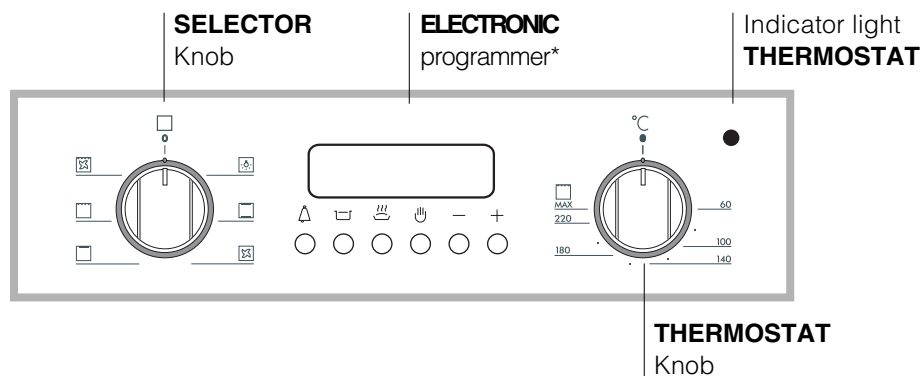
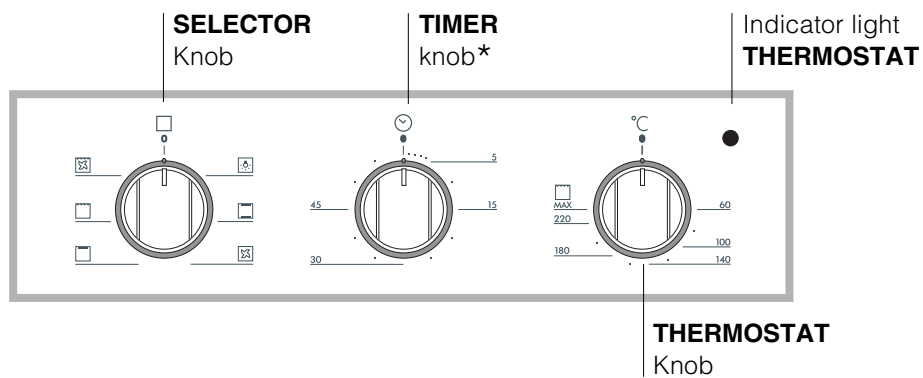

\* Only on certain models.

! The first time you use your appliance, heat the empty oven with its door closed at its maximum temperature for at least an hour. Ensure that the room is well ventilated before switching the oven off and opening the oven door. The appliance may produce a slightly unpleasant odour caused by the burning away of protective substances used during the manufacturing process.

## Starting the oven

1. Select the desired cooking mode by turning the SELECTOR knob.
2. Select the desired temperature with the THERMOSTAT knob. See the Cooking advice table for cooking modes and the suggested cooking temperatures (*see Cooking Modes*).
3. When lit, the THERMOSTAT indicator light indicates that the oven is heating up to the temperature set.
4. You may do the following during cooking:
  - change the cooking mode by turning the SELECTOR knob.
  - change the temperature by turning the THERMOSTAT knob.
  - stop cooking by turning the SELECTOR knob to the "0" position.

! Never put objects directly on the oven bottom to avoid damaging the enamel coating.

! Always place cookware on the rack(s) provided.

## Cooling ventilation

In order to cool down the external temperature of the oven, some models are fitted with a cooling fan that blows out air between the control panel and the oven door.

! Once the cooking has been completed, the cooling fan remains on until the oven has cooled down sufficiently.

## Oven light

It goes on when selecting  with the SELECTOR knob. It stays on when a cooking mode is selected.

## How to use the timer\*

1. To set the buzzer, turn the TIMER knob clockwise almost one complete revolution.
2. Turn the knob anticlockwise to set the desired time: align the minutes shown on the TIMER knob with the indicator on the control panel.
3. The timer operates in minutes: when the selected time has elapsed, a buzzer will sound.

! The timer does not turn the oven on or off.

\* Only on certain models

# The electronic cooking programmer

GB

This feature allows you to program the oven or the grill as follows:

- delayed cooking time for a specified period;
- immediate start for a specified period;
- timer.

## Button Functions:

- ☒ : Timer with hours and minutes;
- ☒ : cooking time;
- ☒ : end cooking time;
- ☒ : Manual change;
- ☒ : set cooking time (to count down);
- ☒ : set cooking time (to start from zero)

## How to reset the digital clock

After the appliance has been connected to the power supply, or after a power cut, the clock display will automatically reset to **0:00** and begin to blink.

- Press the ☒ and ☒ buttons consecutively and then reset the time (within 4 seconds) using the ☒ and ☒ buttons.  
The button ☒ advances the hours.  
The button ☒ decreases the hours.

The time can also be changed in the following two ways:

1. Repeat all of the steps above.
2. Press the ☒ button, and then use the ☒ and ☒ buttons to reset the time.

## Manual operation of the oven

Once the time has been set, the programmer automatically switches to manual mode.

! Press the ☒ button to restore the manual mode after every "Automatic" cooking session.

## Delayed cooking time for a specified period

The total cooking time as well as the time at which the cooking will finish must be set. If we assume that the time display reads 10:00:

1. Turn the oven control knob to the setting and temperature desired (example: static oven mode at 200°C).
2. Press the button ☒ and then set the cooking time (within four seconds) using the ☒ and ☒ buttons. Supposing the cooking time is set to 30 minutes, the display will read as follows:

☒ 0:30

Release the button, and within 4 seconds, the current time will reappear with the ☒ symbol along with the word "auto"

3. Press the button ☒ and then use the ☒ and ☒ buttons to set the time for when the cooking program should end. Let us imagine this time to be 1:00 p.m.

☒ 13:00

4. After the button has been released, the current time will be displayed after approximately 4 seconds:

☒ 10:00

When "auto" is on, it indicates that the length of cooking time and the time it is due to finish have been programmed in automatic mode. At this point, the oven will turn on automatically at 12:30 and turn off after 30 minutes. When the oven is turned on, the symbol ☒ will be displayed for the entire cooking time. The cooking duration can be displayed at any time by pressing the button ☒, and the time it is due to finish may be displayed by pressing the button ☒. Once cooking is completed, the timer will ring; to turn it off, simply press any button except the ☒ and ☒ buttons.

## Immediate start for a specified period

By programming just the duration (points 1 and 2 of the "Delayed cooking time for specified period" section), cooking will begin immediately.

## To cancel a cooking schedule already programmed

Press the ☒ button, and use the ☒ button to set the time to:

0:00

then press the manual cooking mode button ☒.

## Timer Feature

The timer feature allows you to enter a specific amount of time and begins to count down. This feature does not turn the oven on or off; it merely sounds when the time has elapsed.

When the button ☒ has been pressed, the display will read as follows:

0:00

Then use the ☒ and ☒ buttons to set the desired time. As soon as the button has been released, the timer will start to count down and the current time will be displayed.

10:00

After the time has expired, an audible signal will be emitted, which can be turned off by pressing any button (except the ☒ and ☒ buttons). At this point the symbol ☒ will also turn off.

## Correction/Cancellation of data

- The data entered can be changed at any time by pressing the corresponding button and the ☒ or ☒ buttons.
- When the data for the cooking duration is cancelled, the data for the time cooking is due to end is also cancelled automatically, and vice versa.
- If the oven has already been programmed, it will not accept times for the end of cooking which are before the start of the programmed cooking process.

## Cooking modes

! A temperature value can be set for all cooking modes between 60°C and Max, except for

- GRILL (recommended: set only to MAX power level);
- GRATIN (recommended: do not exceed 200°C).

### **TRADITIONAL OVEN** mode

Both the top and bottom heating elements will come on. With this traditional cooking mode, it is best to use one cooking rack only; if more than one rack is used, the heat will be distributed unevenly.

### **MULTI-COOKING** mode

All the heating elements (top and bottom), as well as the fan, will come on. Since the heat remains constant throughout the oven, the air cooks and browns food uniformly. A maximum of two racks may be used at the same time.

### **TOP OVEN** mode

The top heating element comes on. This mode can be used to brown food at the end of cooking.

### **GRILL** mode

The top heating element comes on. The extremely high and direct temperature of the grill makes it possible to brown the surface of meats and roasts while locking in the juices to keep them tender. The grill is also highly recommended for dishes that require a high temperature on the surface: such as beef steaks, veal, rib steak, filets, hamburgers etc... Some grilling examples are included in the "Practical Cooking Advice" paragraph. Always cook in this mode with the oven door closed.

### **GRATIN** mode

The top heating element, as well as the fan, will come on. This combination of features increases the effectiveness of the unidirectional thermal radiation of the heating elements through forced circulation of the air throughout the oven. This helps prevent food from burning on the surface, allowing the heat to penetrate right into the food. Always cook in this mode with the oven door closed.

## Practical cooking advice

! Do not place racks in position 1 and 5 during fan-assisted cooking. Excessive direct heat can burn temperature sensitive foods.

! In the GRILL and GRATIN cooking modes, place the dripping pan in position 1 to collect cooking residues (fat and/or grease).

### MULTI-COOKING

- Use position 2 and 4, placing the food that requires more heat on 2.
- Place the dripping pan on the bottom and the rack on top.

### GRILL

- Insert the rack in position 3 or 4. Place the food in the centre of the rack.
- We recommend that you set the maximum power level. The top heating element is regulated by a thermostat and may not always be on.

### PIZZA

- For best results when cooking pizza, use the MULTI-COOKING mode.
- Use a light aluminium pizza pan. Place it on the rack provided.  
For a crispy crust, do not use the dripping pan (prevents crust from forming by extending cooking time).
- If the pizza has a lot of toppings, we recommend adding the mozzarella cheese on top of the pizza halfway through the cooking process.

## Cooking advice table

Cooking modes	Foods	Weight (in kg)	Rack position	Pre-heating time (min)	Recommended temperature	Cooking time (minutes)
<b>Convection Oven</b>	Duck	1	3	15	200	65-75
	Roast veal or beef	1	3	15	200	70-75
	Pork roast	1	3	15	200	70-80
	Biscuits (short pastry)	-	3	15	180	15-20
	Tarts	1	3	15	180	30-35
<b>Multi-cooking</b>	Pizza (on 2 racks)	1	2 and 4	15	230	15-20
	Lasagne	1	3	10	180	30-35
	Lamb	1	2	10	180	40-45
	Roast chicken + potatoes	1+1	2 and 4	15	200	60-70
	Mackerel	1	2	10	180	30-35
	Plum cake	1	2	10	170	40-50
	Cream puffs (on 2 racks)	0.5	2 and 4	10	190	20-25
	Biscuits (on 2 racks)	0.5	2 and 4	10	180	10-15
	Sponge cake (on 1 rack)	0.5	2	10	170	15-20
	Sponge cake (on 2 racks)	1	2 and 4	10	170	20-25
Savoury pies	1.5	3	15	200	25-30	
<b>Top oven</b>	Browning food to perfect cooking	-	3/4	15	220	-
<b>Grill</b>	Soles and cuttlefish	1	4	5	Max	8-10
	Squid and prawn kebabs	1	4	5	Max	6-8
	Cod filet	1	4	5	Max	10
	Grilled vegetables	1	3 or 4	5	Max	10-15
	Veal steak	1	4	5	Max	15-20
	Cutlets	1	4	5	Max	15-20
	Hamburgers	1	4	5	Max	7-10
	Mackerels	1	4	5	Max	15-20
	Toasts	4	4	5	Max	2-3
<b>Gratin</b>	Grilled chicken	1.5	2	5	200	55-60
	Cuttlefish	1.5	2	5	200	30-35



! The appliance was designed and manufactured in compliance with international safety standards. The following warnings are provided for safety reasons and must be read carefully.

## General safety

- The appliance was designed for domestic use inside the home and is not intended for commercial or industrial use.
- The appliance must not be installed outdoors, even in covered areas. It is extremely dangerous to leave the appliance exposed to rain and storms.
- When handling the appliance, always use the handles provided on the sides of the oven.
- Do not touch the appliance with bare feet or with wet or moist hands and feet.
- The appliance must be used to cook food by adults only and according to the instructions in this manual.
- **When the appliance is in use, the heating elements and some parts of the oven door become extremely hot. Make sure you don't touch them and keep children well away.**
- Ensure that the power supply cable of other electrical appliances does not come into contact with the hot parts of the oven.
- The openings used for ventilation and dispersion of heat must never be covered.
- Always grip the oven door handle in the centre: the ends may be hot.
- Always use oven gloves to place cookware in the oven or when removing it.
- Do not use aluminium foil to line the bottom of the oven.
- Do not place flammable materials in the oven: if the appliance is switched on by mistake, it could catch fire.
- Always make sure the knobs are in the “●”/“○” position when the appliance is not in use.
- When unplugging the appliance always pull the plug from the mains socket, do not pull on the cable.
- Never carry out any cleaning or maintenance work without having unplugged the plug from the mains.
- In the case of a malfunction, under no circumstances should you attempt to repair the appliance yourself. Repairs carried out by inexperienced persons may cause injury or further malfunctioning of the appliance. Contact a Service Centre (*see Assistance*).

- Do not rest heavy objects on the open oven door.

## Disposal

- Observe local environmental standards when disposing packaging material for recycling purposes. Observe existing legislation when disposing of the old appliance.
- The European Directive 2002/96/EC on Waste Electrical and Electronic Equipment (WEEE), requires that old household electrical appliances must not be disposed of in the normal unsorted municipal waste stream. Old appliances must be collected separately in order to optimise the recovery and recycling of the materials they contain and reduce the impact on human health and the environment. The crossed out “wheeled bin” symbol on the product reminds you of your obligation, that when you dispose of the appliance it must be separately collected. Consumers should contact their local authority or retailer for information concerning the correct disposal of their old appliance.

## Respecting and conserving the environment

- By using the appliance in the hours between late afternoon and early morning, you can help reduce the work load placed on electrical companies.
- Always keep the oven door closed when using the GRILL and GRATIN modes: to attain best results and to save energy (approximately 10%).
- Regularly check the door seals and wipe clean to ensure they are free of debris so that they stick properly to the door and do not allow heat to disperse.



## Recycling & Disposal Information

As part of Hotpoint's continued commitment to helping the environment, Hotpoint reserves the right to use quality recycled components to keep down customer costs and minimise material wastage.

Please dispose of packaging and old appliances carefully.

To minimise risk of injury to children, remove the door, plug and cut mains cable off flush with the appliance. Dispose of these parts separately to ensure that the appliance can no longer be plugged into a mains socket, and the door cannot be locked shut.

# Maintenance and care

GB

## Switching the appliance off

Disconnect your appliance from the electricity supply before carrying out any work on it.

## Cleaning the appliance

! Never use steam cleaners or pressure cleaners on the appliance.

- The stainless-steel or enamel-coated external parts as well as the rubber seals may be cleaned using a sponge that has been soaked in lukewarm water and neutral soap. If these stains are difficult to remove, use only specialised products. After cleaning, rinse and dry thoroughly. Do not use abrasive powders or corrosive substances.
- Ideally, the inside of the oven should be cleaned after each use, when it is still lukewarm. Use hot water and detergent, rinse and dry with a soft cloth. Do not use abrasive products.
- The accessories can be washed like everyday crockery (even in your dishwasher).

## Cleaning the oven door

Clean the glass part of the oven door using a sponge and a non-abrasive cleaning product, then dry thoroughly with a soft cloth. Do not use rough abrasive material or sharp metal scrapers as these could scratch the surface and cause the glass to crack. To clean more thoroughly, you can remove the oven door.

1. Open the oven door fully (*see diagram*).
2. Lift up and turn the small levers located on the two hinges (*see diagram*).

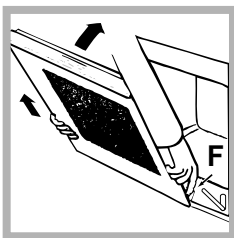
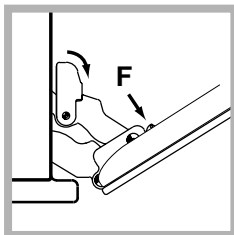
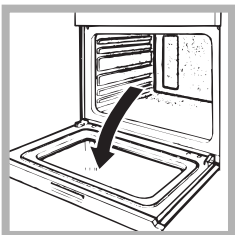

3. Grip the door on the two external sides and close it approximately half way. Unlock the door by pressing on the clamps **F**, then pull the door towards you lifting it out of its seat (*see diagram*).

To replace the door, reverse this sequence.

## Inspecting the seals

Check the door seals around the oven periodically. If the seals are damaged, please contact your nearest After-sales Service Centre (*see Assistance*). We recommend not using the oven until the seals have been replaced.

## Replacing the light bulb

To replace the oven light bulb:

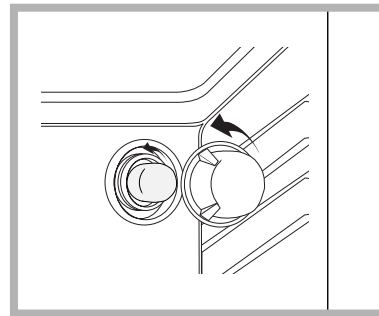

1. Remove the glass cover of the lamp-holder.
2. Remove the light bulb and replace it with a similar one: Wattage 25 W, cap E 14.
3. Replace the glass cover (*see diagram*).

## After Sales Service

No one is better placed to care for your Hotpoint appliance during the course of its working life than us - the manufacturer.

### Essential Contact Information

#### Hotpoint Service

We are the largest service team in Europe offering you access to 400 skilled telephone advisors and 1100 fully qualified engineers on call to ensure you receive fast, reliable, local service.

**UK: 08709 066 066**  
**Republic of Ireland: 0818 313 413**  
**[www.hotpointservice.co.uk](http://www.hotpointservice.co.uk)**

**Please note: Our advisors will require the following information:**

**Model number:**   
**Serial number:**

#### Parts and Accessories

We supply a full range of genuine replacement parts as well as accessory products that protect and hygienically clean your appliance to keep it looking good and functioning efficiently throughout its life.

**UK: 08709 077 077**  
**Republic of Ireland: 0818 313 413**  
**[www.hotpointservice.co.uk](http://www.hotpointservice.co.uk)**

#### Appliance Registration

We want to give you additional benefits of Hotpoint ownership. To activate your free 5 year parts guarantee you must register your appliance with us.

**UK: 0870 6092094**  
**Republic of Ireland: 01 230 0800**  
**[www.hotpointservice.co.uk](http://www.hotpointservice.co.uk)**

**Indesit Company UK Ltd. Morley Way, Peterborough, PE2 9JB**  
Indesit Company Unit 49 Airways Industrial Estate, Dublin 17



## Recycling & Disposal Information

As part of Hotpoint's continued commitment to helping the environment, Hotpoint reserves the right to use quality, recycled components to keep down customer costs and minimise material wastage.

Please dispose of packaging and old appliances carefully. To minimise the risk of injury to children, remove the door, plug and cut the mains cable off flush with the appliance. Dispose of these parts separately to ensure that the appliance can no longer be plugged into a mains socket, and the door cannot be locked shut.

## Guarantee

### 12 Months Parts and Labour Guarantee

Your appliance has the benefit of our manufacturer's guarantee, which covers the cost of breakdown repairs for twelve months from the date of purchase.

This gives you the reassurance that if, within that time, your appliance is proven to be defective because of either workmanship or materials, we will, at our discretion, either repair or replace the appliance at no cost to you.

This guarantee is subject to the following conditions:

- The appliance has been installed and operated correctly and in accordance with our operating and maintenance instructions.
- The appliance is used only on the electricity or gas supply printed on the rating plate.
- The appliance has been used for normal domestic purposes only.
- The appliance has not been altered, serviced, maintained, dismantled, or otherwise interfered with by any person not authorised by us.
- Any repair work must be undertaken by us or our appointed agent.
- Any parts removed during repair work or any appliance that is replaced become our property.
- The appliance is used in the United Kingdom or Republic of Ireland.

The guarantee **does not cover**:

- Damage resulting from transportation, improper use, neglect or interference or as a result of improper installation.
- Replacement of any consumable item or accessory . These include but are not limited to: plugs, cables, batteries, light bulbs, fluorescent tubes and starters, covers and filters.
- Replacement of any removable parts made of glass or plastic.

**THIS GUARANTEE WILL NOT APPLY IF THE APPLIANCE HAS BEEN USED IN COMMERCIAL OR NON-DOMESTIC PREMISES.**

### 5 Year Parts Guarantee

Hotpoint also offers you a free 5 year parts guarantee. This additional guarantee is conditional on you registering your appliance with us and the parts being fitted by one of our authorised engineers. There will be a charge for our engineer's time. To activate the extra parts warranty on your appliance, simply call our registration line on **0870 6092094 (ROI 01 230 0800)**.

### Extended Guarantees

We offer a selection of repair protection plans that enable you to fully cover yourself against the expense of repair bills for the life of your policy. To find the ideal plan for you please call our advice line on 08709 **088 088 (ROI 01 230 0233)**.

### Free Helpdesk Service

We have a dedicated team who can provide free advice and assistance with your appliance if you experience any technical difficulties within the first 90 days of ownership. Simply call our Hotpoint Service Hotline on **08709 066 066 (ROI 0818 313 413)** for telephone assistance, or, where necessary, to arrange for an engineer to call. If we cannot resolve the technical problem we will replace your machine or, if you prefer, give you your money back.