



website:<http://www.LGService.com>
e-mail:<http://www.LGService.com/techsup.html>

MICROWAVE OVEN

OWNER'S MANUAL & COOKING GUIDE

PLEASE READ THIS OWNER'S MANUAL
THOROUGHLY BEFORE OPERATING.

MV-1525W
MV-1525B

Thank you for purchasing a GoldStar microwave oven.

Please record the model number and serial number of this unit for future reference. We also suggest you record the details of your contact with GoldStar (LG Electronics U.S.A., Inc.) concerning this unit.

Model No: _____
Serial No: _____
Dealer: _____

Dealer Phone No: _____

Staple your receipt here to prove your retail purchase.

Customer Relations
LG Electronics U.S.A., Inc.
Service Division Bldg. #3
201 James Record Rd.
Huntsville, AL 35824-0126

**PRECAUTIONS TO AVOID POSSIBLE
EXPOSURE TO EXCESSIVE
MICROWAVE ENERGY...**

- (a) Do not attempt to operate this oven with the door open since open-door operation can result in harmful exposure to microwave energy. It is important not to defeat or tamper with the safety interlocks.
- (b) Do not place any object between the oven front face and the door or allow soil or cleaner residue to accumulate on sealing surfaces.
- (c) Do not operate the oven if it is damaged. It is particularly important that the oven door closes properly and that there is no damage to the:
 - (1) Door (bent),
 - (2) Hinges and latches (broken or loosened),
 - (3) Door seals and sealing surfaces.
- (d) The oven should not be adjusted or repaired by anyone except properly qualified service personnel.

TABLE OF CONTENTS

PRECAUTIONS TO AVOID POSSIBLE EXPOSURE TO EXCESSIVE MICROWAVE ENERGY	2	Cooking at High Cook Power	13
TABLE OF CONTENTS	3	Auto Touch Cook	13
SAFETY	4	Cooking Guide for Lower Power Levels.....	14
Important Safety Instructions	4	Auto Touch Cook Chart.....	15
INFORMATION	6	Defrost.....	16
Location of Model Number	6	Defrosting Tips	16
Oven Specifications	6	Defrost Chart.....	17
Electrical Rating	6	Two Position Metal Rack.....	18
Electrical Requirements.....	6	COOKING	19
Grounding Instructions	6	Getting the Best Cooking Results	19
Microwave Oven Features	7	Fish & Shellfish	19
Oven Control Panel	8	Appetizers/Sauces/Soups	20
OPERATION	10	Meat	20
Learn about your Microwave Oven	10	Poultry	22
Clock.....	10	Pasta and Rice.....	23
Kitchen Timer.....	10	MAINTENANCE	24
Light Timer.....	10	Care and Cleaning	24
Fan Hi/Lo/Off.....	11	Metal Rack	24
Turntable On/Off	11	Cleaning the Grease Filters	24
Child Lock	11	Charcoal Filter Replacement.....	24
Light Hi/Lo/Off.....	11	Cooktop/Countertop Light Replacement.....	25
Custom Set	11	Oven Light Replacement.....	25
Help.....	12	Questions and Answers	25
Custom Cook	12	Microwave Utensil Guide	26
Hold Warm.....	12	Before Calling for Service	27
EZ on	12	WARRANTY	Inside back cover
More/Less	13		
Cooking at Lower Power Levels	13		

SAFETY

IMPORTANT SAFETY INSTRUCTIONS

The safety instructions below will tell you how to use your oven and avoid harm to yourself or damage to your oven.

⚠ WARNING - To reduce the risk of burns, electric shock, fire, injury to persons, or exposure to excessive microwave energy.

- **Read all the instructions before using your oven.**
- **Do not allow children to use this oven without close supervision.**
- Read and follow the specific **PRECAUTIONS TO AVOID POSSIBLE EXPOSURE TO EXCESSIVE MICROWAVE ENERGY** found on page 2.
- **Do not use** corrosive chemicals or vapors, such as sulfide and chloride, in this appliance. This type of oven is specifically designed to heat, cook, or dry food. It is not designed for industrial or laboratory use.
- **Do not use or store** this appliance outdoors. Do not use this product near water - for example, near a kitchen sink, in a wet basement, or near a swimming pool, and the like.
- **Do not use** the cavity for storage purposes. Do not leave paper products, cooking utensils, or food in the cavity when not in use.
- **Clean the ventilating hood frequently.** Do not allow grease to accumulate on the hood or the filters.
- Use care when cleaning the vent hood filters. Corrosive cleaning agents such as lye-based oven cleaners, may damage the filters.
- **Do not tamper with the built-in safety switches on the oven door.** The oven has several built-in safety switches to make sure the power is off when the door is open.
- When flaming foods under the hood, turn the fan on.
- Suitable for use above both gas and electric cooking equipment 36 inches wide or less.
- **Do not use this oven for commercial purposes.** It is made for household use only.
- **When cleaning the door and the surfaces that touch the door, use only mild, non-abrasive soaps or detergents and a sponge or soft cloth.**
- **If your oven is dropped or damaged,** have it thoroughly checked by a qualified service technician before using it again.
- **To avoid a fire hazard:**
 - **Do not severely overcook food.** Severely overcooked foods can start a fire in the oven. Watch the oven carefully, especially if you have paper, plastic, or other combustibles in the oven.
 - **Do not store combustible items (bread, cookies, etc.) in the oven,** because if lightning strikes the power lines it may cause the oven to turn on.
 - **Do not use wire twist-ties in the oven.** Be sure to inspect purchased items for wire twist-ties and remove them before placing the item in the oven.
- **If a fire should start:**
 - **Keep the oven door closed.**
 - **Turn the oven off.**
 - **Disconnect the power cord or shut off the power at the fuse or circuit breaker panel.**
- **To avoid electric shock:**
 - **This appliance must be grounded.** Connect it only to a properly grounded outlet. See the electrical **GROUNDING INSTRUCTIONS** on page 6.
 - **Do not operate this appliance if it has a damaged cord or plug,** if it is not working properly or if it has been damaged or dropped.
 - **Do not immerse the electrical cord or plug in water.**
 - **Keep the cord away from heated surfaces.**

SAFETY

- **To avoid improperly cooking some foods.**
 - **Do not heat any types of baby bottles or baby food.** Uneven heating may occur and possibly cause personal injury.
 - **Do not heat small-necked containers,** such as syrup bottles.
 - **Do not deep-fat fry in your microwave oven.**
 - **Do not attempt home canning in your microwave oven.**
 - **Do not heat the following items in the microwave oven:** whole eggs in the shell, water with oil or fat, sealed containers, or closed glass jars. These items may explode.
- Do not cover or block any openings in the oven.
- Use your oven only for the operations described in this manual.
- Do not run the oven empty, without food in it.
- Do not let cord hang over edge of table or counter.
- **Preserve the oven floor:**
 - **Do not heat the oven floor excessively.**
 - **Do not** allow the gray film on special microwave-cooking packages to touch the oven floor. Put the package on a microwavable dish.
 - **Do not** cook anything directly on the oven floor or turntable. Use a microwavable dish.
 - Keep a browning dish at least 3/16 inch above floor. Carefully read and follow the instructions for the browning dish. If you use a browning dish incorrectly, you could damage the oven floor.
- Install or locate this appliance only in accordance with the provided installation instructions.
- This appliance should be serviced only by qualified service personnel. Contact the nearest authorized service facility for examination, repair, or adjustment.

SAVE THESE INSTRUCTIONS

FEDERAL COMMUNICATIONS COMMISSION RADIO FREQUENCY INTERFERENCE STATEMENT (U.S.A. ONLY)

WARNING:

This equipment generates and uses ISM frequency energy and if not installed and used properly, that is in strict accordance with the manufacturer's instructions, may cause interference to radio and television reception. It has been type tested and found to comply with limits for ISM Equipment pursuant to part 18 of FCC Rules, which are designed to provide reasonable protection against such interference in a residential installation.

However, there is no guarantee that interference will not occur in a particular installation. If this equipment does cause interference to radio or television reception, which can be determined by turning the equipment off and on, the user is encouraged to try to correct the interference by one or more of the following:

- Reorient the receiving antenna of the radio or television.
- Relocate the Microwave Oven with respect to the receiver.
- Move the microwave oven away from the receiver.
- Plug the microwave oven into a different outlet so that the microwave oven and the receiver are on different branch circuits.

The manufacturer is not responsible for any radio or TV interference caused by **unauthorized modification** to this microwave oven. It is the responsibility of the user to correct such interference.

INFORMATION

Please read this owner's manual. It will tell you how to use all the fine features of this microwave oven.

LOCATION OF MODEL NUMBER

To request service information or replacement parts, the service center will require the complete model number of your microwave oven. The number is on the oven front as shown in the illustration below.

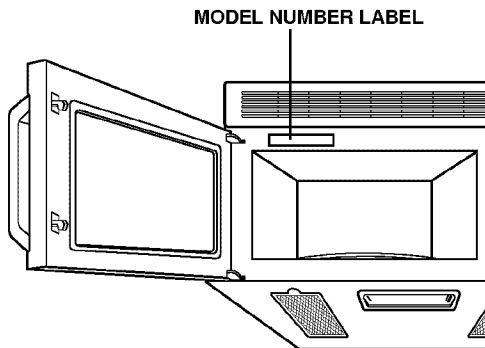

OVEN SPECIFICATIONS

Output Power 1,000W (IEC 705 Standard)
Outer Dimensions 29-15/16" x 16-7/16" x 15-3/8"
Cavity Volume 1.5 Cu.ft
Net Weight 65 lbs.

ELECTRICAL RATING

* Electrical Rating of the Oven: 120V AC, 60Hz
* 13 Amp./ 1,500W (MWO Only)
* 14 Amp./ 1,600W (MWO + Cooktop Lamp + Ventilation Fan)

ELECTRICAL REQUIREMENTS

The oven is designed to operate on a Standard 120V/60Hz household outlet. Be sure the circuit is at least 15A or 20A and the microwave oven is the **only appliance on the circuit**. It is not designed for 50Hz or any circuit other than a 120V/60Hz circuit.

GROUNDING INSTRUCTIONS

This appliance must be grounded. If an electrical short circuit occurs, grounding reduces the risk of electric shock by providing an escape wire for the electric current. The cord for this appliance has a grounding wire with a grounding plug. Put the plug into an outlet that is properly installed and grounded.

⚠ WARNING - If you use the grounding plug improperly, you risk electric shock.

Ask a qualified electrician if you do not understand the grounding instructions or if you wonder whether the appliance is properly grounded.

Because this appliance fits under the cabinet, it has a short power-supply cord. See the separate Installation Instructions for directions on placing the cord properly. Keep the electrical power cord dry and do not pinch or crush it in any way.

If it is necessary to use an extension cord, use only a 3-wire extension cord that has a 3-blade grounding plug, and a 3-slot receptacle that will accept the plug on the appliance. The marked rating of the extension cord shall be equal to or greater than the electrical rating of the appliance.

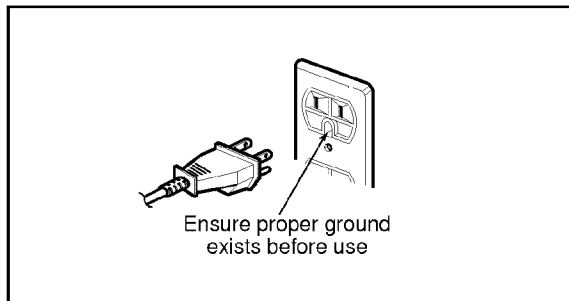

For a permanently connected appliance:

This appliance must be connected to a grounded, metallic, permanent wiring system, or an equipment grounding conductor should be run with the circuit conductors and connected to the equipment grounding terminal or lead on the appliance.

INFORMATION

MICROWAVE OVEN FEATURES

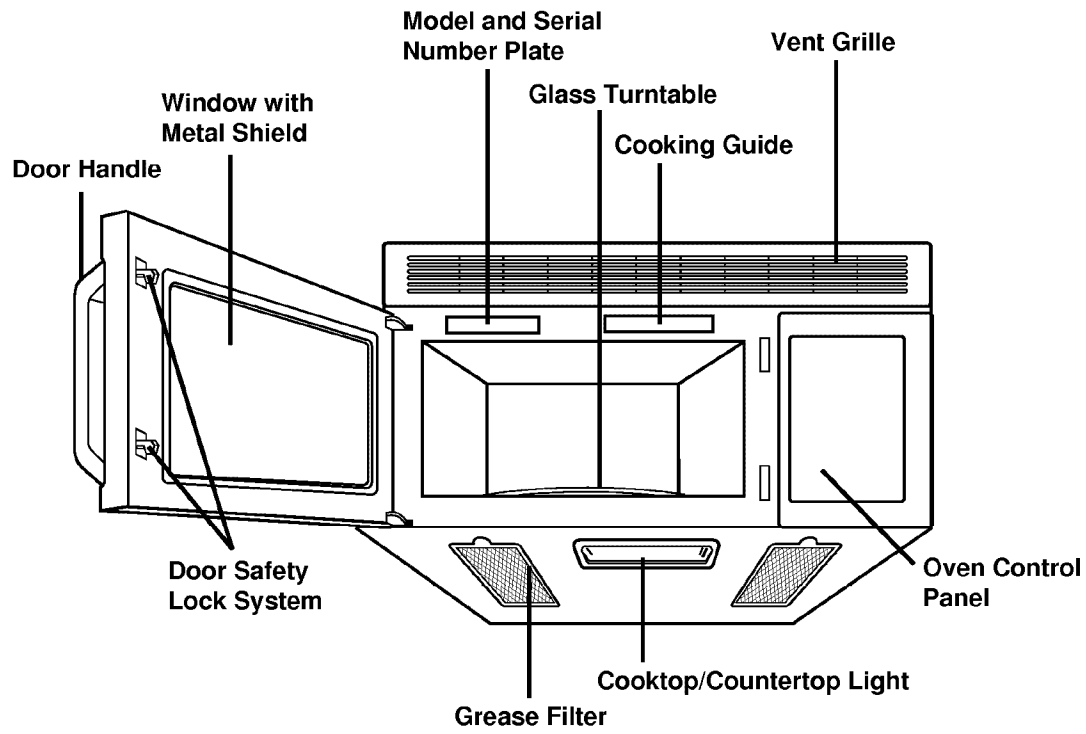

INFORMATION

OVEN CONTROL PANEL

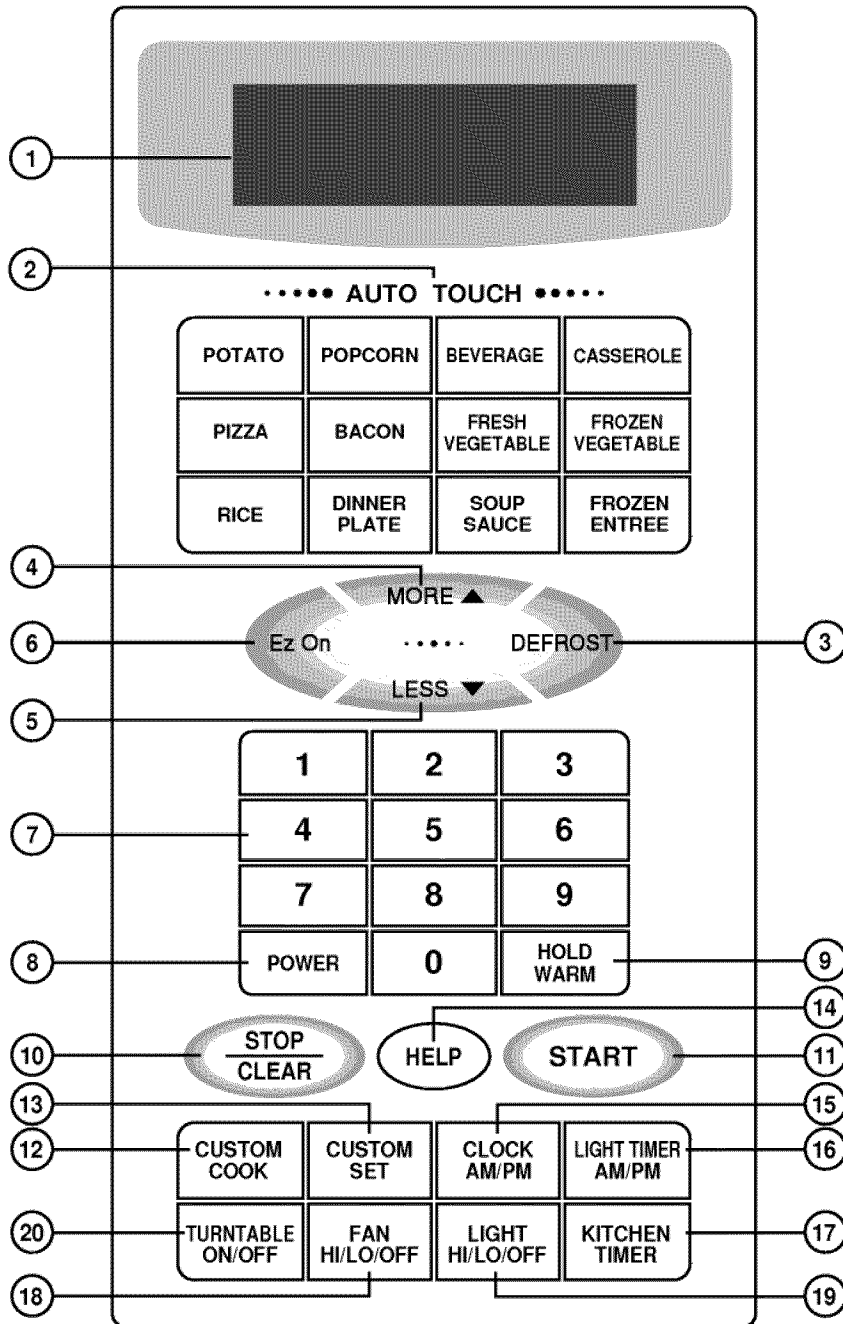

INFORMATION

1. **DISPLAY:** The display includes a clock and indicators to tell you time of day, cooking time settings, and cooking functions selected.
2. **AUTO TOUCH COOK:** Touch these keys let you cook foods easily. See page 13 for more information.
3. **DEFROST:** Ground Meat, Poultry, Steaks/Chops. Touch on pad to select food type and defrost food by weight. See page 16 for more information.
4. **MORE:** Touch this pad to add ten seconds of cooking time each time you press it. See page 13 for more information.
5. **LESS:** Touch this pad to subtract ten seconds of cooking time each time you press it. See page 13 for more information.
6. **EZ ON:** Touch this pad to cook for one minute at 100% power level. See page 12 for more information.
7. **NUMBER:** Touch number pads to enter cooking time, power level, quantities, or weights.
8. **POWER:** Touch this pad to select a cooking power level.
9. **HOLD WARM:** Touch this pad to keep hot, cooked foods safely warm in your microwave oven for up to 99 minutes 99 seconds. See page 12 for more information.
10. **STOP/CLEAR:** Touch this pad to stop the oven or to clear all entries.
11. **START:** Touch this pad to start a function. If you open the door after oven begins to cook, START again.
12. **CUSTOM COOK:** Touch this pad to recall one cooking instruction previously programmed into memory. See page 12 for more information.
13. **CUSTOM SET:** Touch this pad to change the oven's default settings for sound, clock, display speed, defrost weight, and demo mode operations. See page 11 for more information.
14. **HELP:** Touch this pad to learn how to use each oven function. See page 12 for more information.
15. **CLOCK(TIME OF DAY):** Touch this pad to enter the time of day. See page 10 for more information.
16. **LIGHT TIMER:** Touch this pad to set the light timer. See page 10 for more information.
17. **KITCHEN TIMER:** Touch this pad to set the kitchen timer. See page 10 for more information.
18. **FAN HI/LO/OFF:** Touch this pad to turn the fan on or off. See page 11 for more information.
19. **LIGHT HI/LO/OFF:** Touch this pad to turn on the cooktop/countertop light. See page 11 for more information.
20. **TURNTABLE ON/OFF:** Touch this pad to turn off the turntable. T/TABLE OFF will appear in the display. See page 11 for more information.

OPERATION





LEARN ABOUT YOUR MICROWAVE OVEN

This section discusses the concepts behind microwave cooking and introduces you to the basics you need to know to operate your microwave oven. Please read this information before use.

CLOCK(TIME OF DAY)

This oven includes a 24-hour clock.

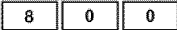



Example: To set 8:00 AM.

-  1. Touch **STOP/CLEAR**.
-  2. Touch **CLOCK**.
(Press once for AM, twice for PM.)
-  3. Enter the time by using the number key pad.
-  4. Touch **START**.

KITCHEN TIMER

You can use your microwave oven as a timer. Use the Timer for timing up 99 minutes, 99 seconds.

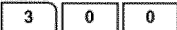





Example: To count 3 minutes.

-  1. Touch **STOP/CLEAR**.
-  2. Touch **KITCHEN TIMER**.
-  3. Enter the time by using the number key pad.
-  4. Touch **START**.
When the time is over, you will hear one long beep and **END** will display.

LIGHT TIMER

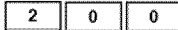

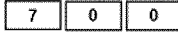
You can set the **LIGHT** to turn on and off automatically at any time you want. The light comes on at the same time every day until reset.

Example: Turn on 2:00 AM, turn off 7:00 AM.

-  1. Touch **STOP/CLEAR**.
-  2. Touch **LIGHT TIMER**.
(Press once for AM, twice for PM.)
-  3. Enter the time you want the **LIGHT** to turn on.
-  4. Touch **LIGHT TIMER** again.
(Press once for AM, twice for PM.)
-  5. Enter the time you want the **LIGHT** to turn off.
-  6. Touch **START**.

NOTE: To reset that time to turn on and off the **LIGHT**, repeat steps 2 to 6.

Example: To cancel the LIGHT TIMER.

-  1. Touch **LIGHT TIMER**.
-  2. Touch **STOP/CLEAR**.

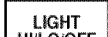
NOTE: If you want to cancel the **LIGHT TIMER** in operation, you should touch  key.

OPERATION

FAN HI/LO/OFF



The FAN moves steam and other vapors from the surface cooking. Touch FAN once for High fan speed, twice for Low fan speed, or three times to turn the fan off.

NOTE: If the temperature gets too hot around the microwave oven, the fan in the vent hood will automatically turn on at the LOW setting to cool the oven. It may stay on up to an hour to cool the oven. When this occurs, **you can not turn the fan off manually.**

TURNTABLE ON/OFF

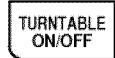

For best cooking results, leave the turntable on. It can be turned off for large dishes. Press TURNTABLE ON/OFF to turn the turntable on or off.

NOTE: Sometimes the turntable can become hot to touch. Be careful touching the turntable during and after cooking.

CHILD LOCK

You may lock the control panel to prevent the microwave from being accidentally started or used by children.

To set the child lock.



1. Touch **STOP/CLEAR**.

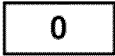

2. Touch and hold **0** more than 4 seconds. **LOCKED** will appear in the display window with two beeps.

To cancel the child lock.

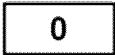

1. Touch and hold **0** more than 4 seconds. **LOCKED** will disappear and you hear two beeps. At this time the oven is ready.

LIGHT HI/LO/OFF



Touch LIGHT once for bright light, twice for night light, or three times to turn the light off.

CUSTOM SET

You can change the default values for beep sound, clock, display speed, defrost weight, and demo mode operations.

See following chart for more information.

NUMBER	FUNCTION	NUMBER	RESULT
1	Beep ON/OFF control	1	Sound ON
		2	Sound OFF
2	Clock display control	1	Clock ON
		2	Clock OFF
3	Display	1	Slow speed
		2	Normal speed
		3	Fast speed
4	Defrost weight mode select	1	Lbs.
		2	Kg.
5	Demo mode select	1	Demo ON
		2	Demo OFF

Example: To change defrost weight mode. (from Lbs. to Kg.)



1. Touch **STOP/CLEAR**.



2. Touch **CUSTOM SET**.

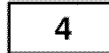

3. Touch number **4**.

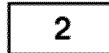



4. Touch number **2**.

OPERATION

HELP

The HELP pad display feature information and helpful hints. Press HELP, then select a key pad.





Example: To learn about POPCORN.

1. Touch  **STOP/CLEAR**.
2. Touch  **HELP**.
3. Touch  **POPCORN**.

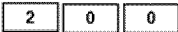

CUSTOM COOK

CUSTOM COOK lets you recall one cooking instruction previously placed in memory and begin cooking quickly.

Example: To memorize for 2 minutes.

1. Touch  **STOP/CLEAR**.
2. Touch  **CUSTOM COOK**.
3. Enter the cook time.

4. Touch  **START**.



Example: To recall the custom cook.

1. Touch  **STOP/CLEAR**.
2. Touch  **CUSTOM COOK**.
3. Touch  **START**.
When the cook time is over, you will hear three beeps and **END** will display.

HOLD WARM

You can safely keep hot, cooked food warm in your microwave oven for up to 99 minutes 99 seconds. You can use HOLD WARM by itself or to follow a cooking cycle automatically.

Example: To use the hold warm.

1. Touch  **STOP/CLEAR**.
2. Touch  **HOLD WARM**.
3. Touch  **START**.



NOTES:

- **HOLD WARM** operates for up to 99 minutes 99 seconds.
- **Food cooked covered** should be covered during HOLD WARM.
- **Pastry items** (pies, turnovers, etc.) should be uncovered during HOLD WARM.
- **Complete meals** kept warm on a dinner plate could be covered during HOLD WARM.

Ez On

Ez On lets you cook or reheat food for one minute at 100% Power. You can also use it to extend cooking time in multiples of one minute, up to 99 minutes 59 seconds.

Example: To cook for 2 minutes.

1. Touch  **STOP/CLEAR**.
2. Touch  **Ez On** twice.

OPERATION

MORE/LESS

By using the MORE or LESS keys, all of the AUTO TOUCH, TIME COOK program and etc. can be adjusted to cook food for a longer or shorter time. Pressing MORE will add 10 seconds of the cooking time each time you press it. Pressing LESS will subtract 10 seconds of cooking time each time you press it.

Example: To adjust the 1.75 oz POPCORN cooking time for a longer time.



1. Touch **STOP/CLEAR**.

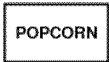

2. Touch **POPCORN** one time.



4. Touch **MORE**.

NOTE: Press the **MORE** or **LESS** key during time countdown.

COOKING AT HIGH COOK POWER

Example: To cook food for 8 minutes 30 seconds.



1. Touch **STOP/CLEAR**.



2. Enter the cook time.



3. Touch **START**.

When the cook time is over, you will hear three beeps and **END** will display.

COOKING AT LOWER POWER LEVELS

HIGH power cooking does not always give you the best results with foods that need slower cooking, such as roasts or custards. Your oven has 9 power settings in addition to HIGH.

Example: To cook food for 7 minutes 30 seconds at 70% power.



1. Touch **STOP/CLEAR**.

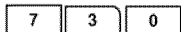

2. Enter the cook time.

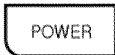

3. Touch **POWER**.



4. Enter the power level.



5. Touch **START**.

When the cook time is over, you will hear three beeps and **END** will display.

AUTO TOUCH COOK

Your oven's menu has been preprogrammed to cook food automatically.

Tell the oven what you want. Then let you microwave oven cook your selections. For more information, see the Auto Touch Cook Chart on page 15.

Example: To cook popcorn, simply follow the step below



1. Touch **STOP/CLEAR**.

* Place popcorn in the oven and close the door.

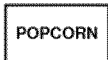

2. Touch **POPCORN**.

**one time for 1.75 oz.
two times for 3.0 oz.
three times for 3.5 oz.**

The oven begins the cooking you selected without the need to touch **START**. Be sure to close the door before selecting categories.

OPERATION

COOKING GUIDE FOR LOWER POWER LEVELS

The nine power levels in addition to HIGH allow you to choose the best power level for the food you are cooking. Below are listed all the power levels,

examples of foods best cooked at each level, and the amount of microwave power you are using.

POWER LEVEL	MICROWAVE OUTPUT	USE
10 HIGH	100%	<ul style="list-style-type: none"> •Boil water. •Cook ground beef. •Make candy. •Cook fresh fruits and vegetables. •Cook fish and poultry. •Preheat browning dish.
9	90%	<ul style="list-style-type: none"> •Reheat meat slices quickly. •Saute onions, celery, and green pepper.
8	80%	<ul style="list-style-type: none"> •All reheating. •Cook scrambled eggs.
7	70%	<ul style="list-style-type: none"> •Cook breads and cereal products. •Cook cheese dishes, veal. •Cook cakes, muffins, brownies, cupcakes.
6	60%	<ul style="list-style-type: none"> •Cook pasta.
5	50%	<ul style="list-style-type: none"> •Cook meats, whole poultry. •Cook custard. •Cook whole chicken, turkey, spare ribs, rib roast, sirloin roast.
4	40%	<ul style="list-style-type: none"> •Cook less tender cuts of meat. •Reheat frozen convenience foods.
3	30%	<ul style="list-style-type: none"> •Thawing meat, poultry, and seafood. •Cooking small quantities of food. •Finish cooking casserole, stew, and some sauces.
2	20%	<ul style="list-style-type: none"> •Soften butter and cream cheese. •Heating small amounts of food.
1	10%	<ul style="list-style-type: none"> •Soften ice cream. •Raise yeast dough.
0		<ul style="list-style-type: none"> •Standing time.

OPERATION

AUTO TOUCH COOK CHART

KEY	TOUCH KEYPAD	QUANTITY	DIRECTIONS
FRESH VEGETABLE	1 Time	1 cup and 2 tbsp water	Place in a microwavable bowl or casserole. Add water according to the quantity. Cover with plastic wrap and vent. After cooking, let stand 5 minutes.
	2 Times	2 cups and 1/4 cup of water	
	3 Times	3 cups and 1/3 cup of water	
	4 Times	4 cups and 1/2 cup of water	
FROZEN VEGETABLE	1 Time	4 oz.	Place in a microwavable bowl or casserole. Cover with plastic wrap and vent. After cooking, let stand 5 minutes.
	2 Times	8 oz.	
	3 Times	12 oz.	
	4 Times	16 oz.	
RICE	1 Time	1 cup and 2 cups of water	In large microwavable casserole, combine water, rice, margarine and salt. Cover with microwavable lid or plastic wrap and vent. After cooking, let stand covered for 5 minutes.
	2 Times	2 cups and 4 cups of water	
CASSEROLE	1 Time	1 cup	Place in a microwavable bowl or casserole. Cover with plastic wrap and vent.
	2 Times	2 cups	
	3 Times	3 cups	
	4 Times	4 cups	
PIZZA (Refrigerated)	1 Time	1 slice (5 oz.)	Place on a low plate & paper towel. Do not cover. Use MORE/LESS to adjust - depend on size of slice and what toppings.
	2 Times	2 slices (10 oz.)	
	3 Times	3 slices (15 oz.)	
SOUP/SAUCE	1 Time	1 cup	Place in shallow microwavable casserole. Cover with vented plastic wrap.
	2 Times	2 cups	
	3 Times	3 cups	
	4 Times	4 cups	
BACON	1 Time	2 slices	Place on paper towel. Cover. Use MORE/LESS to adjust the desired doneness.
	2 Times	3 slices	
	3 Times	4 slices	
	4 Times	5 slices	
	5 Times	6 slices	
POPCORN	1 Time	1.75 oz.	Use popcorn package which is made especially for microwave cooking. Do not try to pop unpopped kernels. Heat only 1 package at a time.
	2 Times	3.0 oz.	
	3 Times	3.5 oz.	
BEVERAGE	1 Time	1 cup	Use mug or microwave-safe cup. Remove the container with care. Use MORE/LESS to adjust.
	2 Times	2 cups	
POTATO	1 Time	1 ea. (8 oz.)	Before baking, pierce potato with fork several times. After baking, let stand for 5 minutes.
	2 Times	2 ea. (16 oz.)	
	3 Times	3 ea. (24 oz.)	
	4 Times	4 ea. (32 oz.)	
DINNER PLATE	1 Time	1 serv.	Cover with plastic wrap vented. After cooking, let stand for 2 minutes.
	2 Times	2 servs.	
FROZEN ENTREE	1 Time	10 oz.	Follow the package directions. Example of one frozen entree is Lasagna with meat sauce, chicken with rice, and sliced turkey breast with rice and vegetable.
	2 Times	20 oz.	

OPERATION

DEFROST

Your microwave oven is preset with three defrost sequences. Using DEFROST is the best way to defrost frozen foods. The Defrost Sequence Table below provides some basic guidelines for using the three defrost sequences.

NOTE: Use the DEFROSTING RACK for three defrost sequences.

Example: To defrost 1.2 lbs. of ground beef.



1. Touch **STOP/CLEAR**.



2. Touch **DEFROST**.



3. Choose food category.

Category	Touch pad number
Ground Meat	1
Poultry	2
Steaks/Chops	3



4. Enter the weight.



5. Touch **START**.

6. After 1/3 of the defrost time is over, The display will prompt you to turn food over. Open door, turn food over, and shield any warm portions.



7. Close the door and restart.

8. After 2/3 of the defrost time is over, the display will prompt you to turn food over. Repeat steps 6 and 7. When the defrost time is over, you will hear three beeps and **END** will display.

NOTE: If you do not open the door within 3 seconds, the display will resume the countdown.

Weight conversion chart

You are probably used to food weights being in pounds and ounces that are fractions of a pound (for example 4 ounces equals 1/4 pound).

However, in order to enter food weight in DEFROST, you must specify pounds and tenths of a pound. If the weight on the food package is in fractions of a pound, you can use the following chart to convert the weight to decimals.

EQUIVALENT OUNCE WEIGHT	NUMBER AFTER DECIMAL
1.6	.10
3.2	.20
4.0	.25 One-Quarter Pound
4.8	.30
6.4	.40
8.0	.50 One- Half Pound
9.6	.60
11.2	.70
12.0	.75 Three-Quarters Pound
12.8	.80
14.4	.90
16.0	1.00 One Pound

DEFROSTING TIPS

- **When using DEFROST**, the weight to be entered is the net weight in pounds and tenths of pounds (the weight of the food minus the container).
- **Use DEFROST** only for raw food. DEFROST gives best results when food to be thawed is a minimum of 0°F (taken directly from a **true** freezer). If food has been stored in a refrigerator-freezer that does not maintain a temperature of 5°F or below, always program a lower food weight (for a shorter defrosting time) to prevent cooking the food.
- **If the food is stored outside** the freezer for up to 20 minutes, enter a lower food weight.
- **The shape of the package** alters the defrosting time. Shallow rectangular packets defrost more quickly than a deep block.
- **Separate pieces** as they begin to defrost. Separated pieces defrost more easily.
- **You can use small pieces** of aluminum foil to shield foods like chicken wings, leg tips, and fish tails, but the foil must not touch the side of the oven. Foil causes arcing, which can damage the oven lining.
- **Shield areas of food** with small pieces of foil if they start to become warm.
- **For better results, a preset standing time** is included in the defrosting time.

OPERATION

DEFROST CHART

Sequence	Food	At Beep	Stand Time
GROUND MEAT	BEEF Ground beef	Turn over. Remove thawed portions and break apart. Return remainder to oven.	5 min.
	Cubes for stew	Turn over. Remove thawed portions with fork.	5 min.
	Hamburger patties	Turn over.	5 min.
	Pot roast	Turn over. Cover warm areas with aluminum foil.	10-20 min.
	Rib roast, Rump roast	Turn over. Cover warm areas with aluminum foil.	10-20 min.
	Chuck roast	Turn over. Cover warm areas with aluminum foil.	10-20 min.
	PORK Bacon, Hot Dogs	Turn over.	2 min.
	Sausage, Links	Turn over.	5 min.
	Sausage, Bulks	Turn over.	5 min.
	Ribs, Roast	Turn over. Cover warm areas with aluminum foil.	10-20 min.
	LAMB Ribs	Turn over. Cover warm areas with aluminum foil.	10-20 min.
	Roasts	Turn over. Cover warm areas with aluminum foil.	10-20 min.
POULTRY	POULTRY Whole Chicken	Turn over(finish defrosting breastside down). Cover warm areas with aluminum foil.	10-20 min. Rinse under cold running water.
	Chicken Pieces	Separate pieces and rearrange.	5-10 min.
	CORNISH HENS Whole, Split	Turn over. Cover warm areas with aluminum foil.	10-20 min. Rinse under cold running water.
	TURKEY Breast(under 6 lbs.)	Turn over and rearrange.	10-20 min. Rinse under cold running water.
STEAKS/ CHOPS	BEEF STEAKS	Turn over. Cover warm areas with aluminum foil.	10-20 min.
	PORK CHOPS	Turn over. Cover warm areas with aluminum foil.	10-20 min.
	LAMB CHOPS	Turn over. Cover warm areas with aluminum foil.	10-20 min.
	FISH Steaks, Whole fish	Turn over and rearrange. Cover head and tail with foil.	5 min.
	Fillets	Turn over. Separate fillets when partially thawed if possible.	5 min. Rinse under cold water to separate.
	SHELLFISH Crabmeat, Shrimp	Rearrange and break apart.	5 min.
	Lobster tails Scallops	Turn over and rearrange. Turn over and rearrange.	5 min. 5 min.

Note: Food to be defrosted must be not more than 6.0 lbs(4.0kg).

OPERATION

TWO POSITION METAL RACK

The two position Metal Rack gives you extra space when cooking in more than one container at the same time. The metal rack can be turned upside-down to help fit taller containers on the bottom of the oven.

NOTE:

- **Rack must be on 4 supports when used.**
- Insert the rack securely into the four supports on the side walls of the oven.
- Turn the rack upside-down when using taller containers on the bottom of the oven.

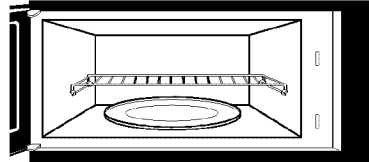
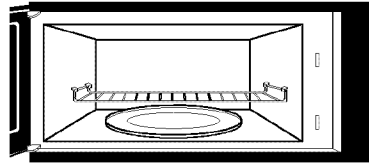

COOKING

GETTING THE BEST COOKING RESULTS

To get the best results from your microwave oven, read and follow the guidelines below.

- **Storage Temperature:** Foods taken from the freezer or refrigerator take longer to cook than the same foods at room temperature. The time for recipes in this book is based on the normal storage temperature of the food.
- **Size:** Small pieces of food cook faster than large ones, pieces similar in size and shape cook more evenly. For even cooking, reduce the power when cooking large pieces of food.
- **Natural Moisture:** Very moist foods cook more evenly because microwave energy is attracted to water molecules.
- **Stir** foods such as casseroles and vegetables from the outside to the center to distribute the heat evenly and speed cooking. Constant stirring is not necessary.

- **Turn over** foods like pork chops, baking potatoes, roasts, or whole cauliflower halfway through the cooking time to expose all sides equally to microwave energy.
- **Place** delicate areas of foods, such as asparagus tips, toward the center of the dish.
- **Arrange** unevenly shaped foods, such as chicken pieces or salmon steaks, with the thicker, meatier parts toward the outside of the dish.
- **Shield**, with **Small** pieces of aluminum foil, parts of food that may cook quickly, such as wing tips and leg ends of poultry.
- **Let It Stand:** After you remove the food from the microwave, cover food with foil or casserole lid and let it stand to finish cooking in the center and avoid overcooking the outer edges. The length of standing time depends on the density and surface area of the food.
- **Wrapping in waxed paper or paper towel:** Sandwiches and many other foods containing prebaked bread should be wrapped prior to microwaving to prevent drying out.

Fish & Shellfish

Cooking Fish and Shellfish: General Directions

- Prepare the fish for cooking.
 - Completely defrost the fish or shellfish.
 - Arrange unevenly shaped pieces with thicker parts toward the outside of the dish. Arrange shellfish in a single layer for even cooking.
 - The type of cover you use depends on how you cook. Poached fish needs a microwavable lid or **vented** plastic wrap.
 - Baked fish, coated fish, or fish in sauce needs to be covered lightly with waxed paper to keep the coating crisp and sauce from getting watery.
- Always set the shortest cooking time. Fish is done when it turns opaque and the thickest part begins to flake. Shellfish is done when the shell turns from pink to red and the flesh is opaque and firm.
- The Fish and Shellfish Cooking Table below provides specific directions with Power Level and Cooking Time settings for most types of fish and shellfish.

Fish And Shellfish Cooking Table

FISH	POWER LEVEL	COOKING TIME	DIRECTIONS
Fish fillets	HI	3 1/2-4 1/2 minutes	Arrange fish in a single layer with thickest portion toward outside edge of 1 1/2 quart microwavable baking dish. Brush with melted butter and season, if desired. Cook covered with vented plastic wrap. Let stand covered 2 minutes. If you are cooking more than 1 lb. of fish, turn the fish halfway through cooking.
Fish steaks	HI	4 1/2-5 1/2 minutes	
Whole fish	7	4 1/2-6 minutes	
Scallops	HI	3 1/2-5 minutes	Arrange in a single layer. Prepare as directed above, except stir instead of turning the shellfish.
Shrimp, shelled	HI	3 1/2-5 minutes	

COOKING

Appetizers / Sauces / Soups Meat

Cooking Appetizers: Tips and Techniques

Recommended

- Crisp crackers, such as melba toast, shredded wheat, and crisp rye crackers are best for microwave use. Wait until party time to add the spreads. Place a paper towel under the crackers while they cook in the microwave oven to absorb extra moisture.
- Arrange individual appetizers in a circle for even cooking.
- Stir dips to distribute heat and shorten cooking time.

Cooking Sauces: Tips and Techniques

- Use a microwavable casserole or glass measuring cup that is at least 2 or 3 times the volume of the sauce.
- Sauces made with cornstarch thicken more rapidly than those made with flour.

Cooking Soups: Tips and Techniques

- Cook soups in a microwavable dish which holds double the volume of the recipe ingredients to prevent boil-over, especially if you use cream or milk in the soup.
- Generally, cover microwaved soups with VENTED plastic wrap or a microwavable lid.
- Cover foods to retain moisture. Uncover foods to retain crispness.
- Avoid overcooking by using the minimum suggested time. Add more time, if necessary, only after checking the food.

Not Recommended

- Appetizers with a crisp coating or puff pastry are best done in a conventional oven with dry heat.
- Breaded products can be warmed in the microwave oven but will not come out crisp.
- Cook sauces made with cornstarch or flour uncovered so you may stir them 2 or 3 times during cooking for a smooth consistency.
- To adapt a conventional sauce or gravy recipe, reduce the amount of liquid slightly.
- Stirring occasionally will help blend flavors, distribute heat evenly, and may even shorten the cooking time.
- When converting a conventional soup recipe to cook in the microwave, reduce the liquid, salt, and strong seasonings.

Cooking Meat: General Directions

- Prepare the meat for cooking.
 - Defrost completely.
 - Trim off excess fat to avoid splattering.
 - Place the meat, fat side down, on a microwavable rack in a microwavable dish.
 - Use oven cooking bag for less tender cuts of meat.
 - Arrange the meat so that thicker portions are toward the outside of the dish.
 - Cover the meat with waxed paper to prevent splattering.
- Tend the meat as it cooks.
 - Drain juices as they accumulate to reduce splattering and keep from overcooking the bottom of the meat.
 - Shield thin or bony portions with strips of foil to prevent overcooking.

NOTE: Keep the foil **at least 1 inch** from the oven walls, and do not cover more than one-third of the meat with foil at any one time.

- Let the meat stand covered with foil 10-15 minutes after you remove it from the oven. The internal temperature of the meat may rise from 5-10°F during standing time.

The Meat Cooking Table on the next page provides detailed directions, Power Level, and Cooking Time settings for most cuts of meat.

COOKING

Meat Cooking Table

MEAT	POWER LEVEL	COOKING TIME	DIRECTIONS
Beef Hamburgers, Fresh or defrosted (4 oz. each) 1 patty 2 patties 4 patties	HI	1-1½ minutes 1½-2 minutes 2½-3½ minutes	Form patties with depression in center of each. Place on microwavable roast rack. Brush with browning agent, if desired. Cover with waxed paper. Turn over halfway through cooking. Let stand covered 1 minute.
Sirloin tip roast (3-4 lbs.)	5	8-10 minutes per pound RARE(135°F) 11-13 minutes per pound MEDIUM(155°F)	Place roast fat side down on microwavable roast rack. Add desired seasonings and cover with waxed paper. Turn meat over halfway through cooking and shield if necessary. Remove roast from microwave oven when desired temperature is reached. Let stand covered with foil 15 minutes.(Temperature may rise about 10°F).
Lamb Lamb roast, rolled boneless (3-4 lbs.)	5	11-12 minutes per pound RARE(135°F) 12-13 minutes per pound MEDIUM(145°F) 13-14 minutes per pound WELL(155°F)	Place roast fat side down on microwavable roast rack. Brush lamb with marinade or desired seasonings such as rosemary, thyme or marjoram. Cover with waxed paper. Turn roast over after 15 minutes, and again after 30 minutes. Shield if necessary. Remove roast from microwave when desired temperature is reached. Let stand covered with foil 15 minutes (Temperature may rise about 10°F).
Pork Bacon slices 2 slices 4 slices 6 slices	HI	1½-2 minutes 2½ -3 minutes 3½-4½ minutes	Place bacon slices on microwavable roast rack. Cover with paper towels. After cooking, let stand 1 minute.
Chops (5-7 oz. each) 2 chops 4 chops	3	18-20 minutes per pound 15-17 minutes per pound	Place chops in microwavable baking dish. Add desired seasonings and cover with vented plastic wrap. Cook until no longer pink or until internal temperature reaches 170°F. Turn chops over halfway through cooking. Let stand covered 5 minutes. (Temperature may rise about 10°F).
Loin Roast, rolled, boneless (3 ½- 4 ½ lbs.)	3	25-27 minutes per pound (165°F)	Place roast in cooking bag in microwavable dish. Add seasonings and browning agent if desired. Close bag loosely with microwavable closure or string. After cooking, let stand in bag 15 minutes. (Temperature may rise about 10°F.) Internal temperature of pork should reach 170°F before serving.
Sausage links, Fresh or Frozen, defrosted (1-2 oz. each) 2 links 4 links 6 links 10 links (8 oz. pkg.)	HI	45-60 seconds 1-1½ minutes 1½-2 minutes 1¾-2 minutes	Pierce links and place on microwavable roast rack. Cover with waxed paper or paper towel. Turn over halfway through cooking. After cooking, let stand covered 1 minute.

COOKING

Poultry

Cooking Poultry: General Directions

- Prepare the poultry for cooking.
 - Defrost completely.
 - Arrange poultry pieces with thicker pieces at the outside edge of the baking dish. When cooking legs, arrange them like the spokes of a wheel.
 - Cover the baking dish with waxed paper to reduce splattering.
 - Use a browning agent or cook with a sauce to give a browned appearance.
- Tend the poultry as it cooks.
 - Drain and discard juices as they accumulate.
 - Shield thin or bony pieces with small strips of aluminum foil to prevent overcooking. Keep foil at **least 1 inch** from the oven walls and other pieces of foil.
- The poultry is done when it is no longer pink and the juices run clear. When done, the temperature in the thigh meat should be 180-185°F.
- Let the poultry stand after cooking covered with foil for 10 minutes.

The Poultry Cooking Table below provides detailed directions, Power Level, and Cooking Time settings for most cuts and types of poultry.

Poultry Cooking Table

POULTRY	POWER LEVEL	COOKING TIME	DIRECTIONS
Chicken pieces (2 1/2-3 lbs).	HI	4 1/2-5 1/2 minutes per pound	Wash, shake the water off, and go on with cooking. Place pieces in a single layer in a microwavable baking dish with thicker pieces to the outside. Brush with butter or browning agent and seasonings if desired. Cover with waxed paper. Cook until no longer pink and juices run clear. Let stand covered 5 minutes.
Chicken whole (3-3 1/2 lbs)	HI	12-13 minutes per pound	Wash, shake the water off, and go on with cooking. Place breast side down on a microwavable roast rack. Brush with butter, or browning agent and seasoning if desired. Cover with waxed paper. Cook 1/3 of estimated time. Turn breast side up, brush with butter, or browning agent. Replace waxed paper. Cook 1/3 of estimated time again. Shield if necessary. Cook remaining 1/3 of estimated time or until no longer pink and juices run clear. Let stand covered with foil 10 minutes. (The temperature may rise about 10°F.) The temperature in the high should be 180°F-185°F when the poultry is done.
Cornish Hens Whole (1-1 1/2 lbs. each)	HI	6-7 minutes per pound	Wash, shake the water off, and go on with cooking. Tie wings to body of hen and the legs to tail. Place hens breast side down on microwavable rack. Cover with waxed paper. Turn breast side up halfway through cooking. Shield bone ends of drumsticks with foil. Remove and discard drippings. Brush with butter or browning agent and seasonings if desired. Cook until no longer pink and juices run clear. Remove hens from microwave when they reach desired temperature. Let stand covered with foil 5 minutes. (Temperature may rise about 10°F). Temperature in breast should be 170°F before serving.

COOKING

Pasta And Rice

Microwave cooking and conventional cooking of pasta, rice, and cereal require about the same amount of time, but the microwave is a more convenient method because you can cook and serve in the same dish.

There is no stirring needed and leftover pasta tastes just like fresh cooked when reheated in the microwave oven.

Cooking Pasta and Rice: Tips and Techniques

- If you are planning to use rice or pasta in a casserole, undercook it so it is still firm.
- Allow for standing time with rice, but not for pasta.
- The Pasta and Rice Cooking Tables below provide specific directions, with Power Level and Cooking Time settings for most common types of pasta and rice.

Pasta Cooking Table

TYPE OF PASTA	POWER LEVEL	COOKING TIME	DIRECTIONS
Spaghetti 4 cups water. Add 8 oz. spaghetti.	HI 5	9 to 10 minutes 7 1/2 to 8 1/2 minutes	Combine hot tap water and salt, if desired. Use a 2-quart microwavable baking dish and cover with vented plastic wrap for spaghetti and lasagna noodles. Use microwavable lid or vented plastic wrap for macaroni and egg noodles. Cook at Power Level HI as directed in chart or until water boils. Stir in pasta; cook covered at Power Level 5 as directed in chart or until tender. Drain in a colander.
Macaroni 3 cups water. Add 2 cups macaroni.	HI 5	6 to 7 minutes 5 1/2 to 6 1/2 minutes	
Lasagna noodles 4 cups water. Add 8 oz. lasagna noodles.	HI 5	7 to 8 minutes 11 to 12 1/2 minutes	
Egg noodles 6 cups water. Add 4 cups noodles.	HI 5	8 to 10 minutes 5 1/2 to 6 1/2 minutes	

Rice Cooking Table

TYPE OF RICE	POWER LEVEL	COOKING TIME	DIRECTIONS
Long grain 2 1/4 cups water. Add 1 cup rice.	HI 5	4 1/2 to 5 1/2 minutes 14 minutes	Combine hot tap water and salt, if desired, in 2 quart microwavable casserole. Cover with microwavable lid or vented plastic wrap. Cook as directed in chart at Power Level HI or until water boils. Stir in rice and any seasonings. Cook covered as directed in chart at Power Level 5 or until water is absorbed and rice is tender. Let stand covered 5 to 10 minutes. Fluff with fork.
Brown 2 1/2 cups water. Add 1 cup rice.	HI 5	4 1/2 to 5 1/2 minutes 28 minutes	
Long grain and wild rice mix 2 1/3 cups water. Add 6 oz. pkg.	Hi 5	4 to 5 minutes 24 minutes	
Quick cooking 1 cup water. Add 1 cup rice.	HI	2 to 3 minutes	Cook water until it boils. Stir rice into boiling water and let stand, covered 5 to 10 minutes or until water is absorbed and rice is tender. Fluff with fork.

MAINTENANCE

CARE AND CLEANING

For best performance and safety, keep the oven clean inside and outside. Take special care to keep the inner door panel and the oven front frame free of food or grease build-up.

Never use rough powder or pads. Wipe the microwave oven inside and out, including the hood bottom cover, with a soft cloth and a warm (not hot) mild detergent solution. Then rinse and wipe dry. Use a chrome cleaner and polish on chrome, metal, and aluminum surfaces. Wipe spatters immediately with a wet paper towel, especially after cooking chicken or bacon. Clean your oven weekly or more often, if needed.

METAL RACK

Wash the metal rack with a mild soap and a soft or nylon scrub brush. Dry completely. Do not use abrasive scrubbers or cleaners to clean rack.

CLEANING THE GREASE FILTERS

The grease filters should be removed and cleaned often, at least once a month.

1. To remove grease filters, slide each filter to the side. Pull filters downward and push to the other side. The filter will drop out.

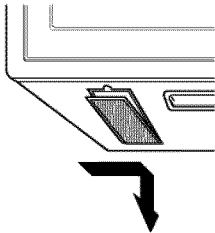

2. Soak grease filters in hot water and a mild detergent. Rinse well and shake to dry. **Do not use ammonia or place in a dishwasher. The aluminum will darken.**

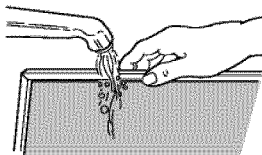

3. To reinstall the filters, slide it into the side slot, then push up and toward oven center to lock.

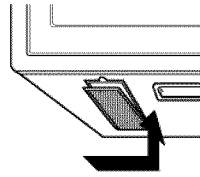

NOTE: Do not operate the hood without the filters in place.

CHARCOAL FILTER REPLACEMENT

If your oven is vented inside, the charcoal filter should be replaced every 6 to 12 months, and more often if necessary. The charcoal filter cannot be cleaned.

To order a new charcoal filter, contact the Parts Department at your nearest Authorized Service Center.

1. Remove the two vent grille mounting screws.
(2 middle screws)

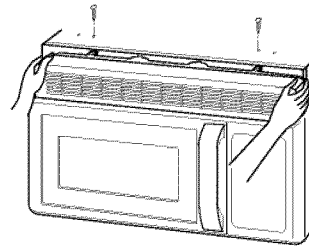

2. Tip the grille forward, then lift it out
3. Remove old filter.

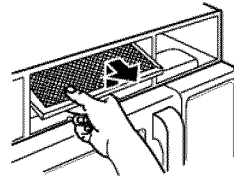

4. Slide a new charcoal filter into place. The filter should rest at the angle shown and set the clock.

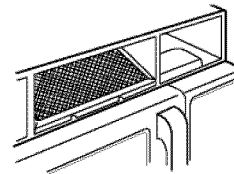

5. Slide the bottom of the vent cover into place. Push the top until it snaps into place. Replace the mounting screws. Turn the power back on at the main power supply and set the clock.

MAINTENANCE

COOKTOP/COUNTERTOP LIGHT REPLACEMENT

1. Unplug the oven or turn off power at the main power supply.

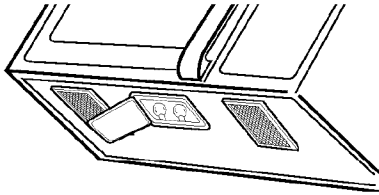

2. Remove the bulb cover mounting screws.
3. Replace bulb(s) with 30 or 40 watt appliance bulb(s).
4. Replace bulb cover, and mount screw.
5. Turn the power back on at the main power supply.

OVEN LIGHT REPLACEMENT

1. Unplug oven or turn off power at the main power supply.
2. Remove the vent cover mounting screws. (2 middle screws)
3. Tip the cover forward, then lift out to remove.

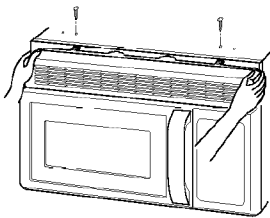

4. Lift up the bulb holder.

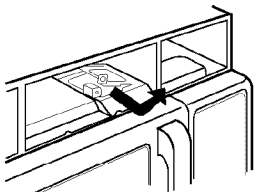
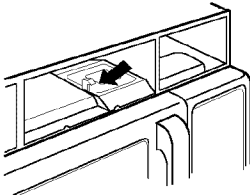

5. Replace bulb with a 30 or 40 watt appliance bulb.
6. Replace the bulb holder.
7. Slide the bottom of the vent cover into place. Push the top until it snaps into place. Replace the mounting screws. Turn the power back on at the main power supply.

QUESTIONS AND ANSWERS

Q. Can I use a rack in my microwave oven so that I may reheat or cook in two levels at a time?

- A. Only use the rack that is supplied with your microwave oven. Use of any other rack can result in poor cooking performance and/or arcing and may damage your oven.

Q. Can I use either metal or aluminum pans in my microwave oven?

- A. Usable metal includes aluminum foil for shielding (use small, flat pieces), and shallow foil trays (if tray is 3/4 inch deep and filled with food to absorb microwave energy). Never allow metal to touch walls or door.

Q. Sometimes the door of my microwave oven appears wavy. Is this normal?

- A. This appearance is normal and does not affect the operation of your oven.

Q. What are the humming noises that I hear when my microwave oven is operating?

- A. You hear the sound of the transformer when the magnetron tube cycles on and off.

Q. Why does the dish become hot when I microwave food in it? I thought that this should not happen.

- A. As the food becomes hot it will conduct the heat to the dish. Use hot pads to remove food after cooking.

Q. What does standing time mean?

- A. Standing time means that food should be taken out of the oven and covered for additional time after cooking. This process allows the cooking to finish, saves energy, and frees the oven for other purpose.

Q. Can I pop popcorn in my microwave oven? How do I get the best results?

- A. Yes. Pop packaged microwave popcorn following manufacturer's guidelines or use the preprogrammed Popcorn pad. Do not use regular paper bags. Use the listening test by stopping the oven as soon as the popping slows to a pop every one or two seconds. Do not try to repop unpopped kernels. You can also use special microwave poppers. When using a popper, be sure to follow manufacturer's directions. Do not pop popcorn in glass utensils.

Q. Why does steam come out of the air exhaust vent?

- A. Steam is normally produced during cooking. The microwave oven has been designed to vent this steam out the top vent.

MAINTENANCE

MICROWAVE UTENSIL GUIDE

USE	DO NOT USE
<p>OVENPROOF GLASS (treated for high intensity heat): utility dishes, loaf dishes, pie plates, cake plates, liquid measuring cups, casseroles and bowls without metallic trim.</p> <p>CHINA: bowls, cups, serving plates and platters without metallic trim.</p> <p>PLASTIC: Plastic wrap (as a cover)-- lay the plastic wrap loosely over the dish and press it to the sides. Vent plastic wrap by turning back one edge slightly to allow excess steam to escape. The dish should be deep enough so that the plastic wrap will not touch the food. As the food heats it may melt the plastic wrap wherever the wrap touches the food. Use plastic dishes, cups, semirigid freezer containers and plastic bags only for short cooking time. Use these with care because the plastic may soften from the heat of the food.</p> <p>PAPER: Paper towels, waxed paper, paper napkins, and paper plates with no metallic trim or design. Look for the manufacturer's label for use in the microwave oven.</p>	<p>METAL UTENSILS: Metal shields the food from microwave energy and produces uneven cooking. Also avoid metal skewers, thermometers or foil trays. Metal utensils can cause arcing, which can damage your microwave oven.</p> <p>METAL DECORATION: Metal-trimmed or metal-banded dinnerware, casserole dishes, etc. The metal trim interferes with normal cooking and may damage the oven.</p> <p>ALUMINUM FOIL: Avoid large sheets of aluminum foil because they hinder cooking and may cause harmful arcing. Use small pieces of foil to shield poultry legs and wings. Keep ALL aluminum foil at least 1 inch from the side walls and door of the oven.</p> <p>WOOD: Wooden bowls and boards will dry out and may split or crack when you use them in the microwave oven. Baskets react in the same way.</p> <p>TIGHTLY COVERED UTENSILS: Be sure to leave openings for steam to escape from covered utensils. Pierce plastic pouches of vegetables or other food items before cooking. Tightly closed pouches could explode.</p> <p>BROWN PAPER: Avoid using brown paper bags. They absorb too much heat and could burn.</p> <p>FLAWED OR CHIPPED UTENSILS: Any utensil that is cracked, flawed, or chipped may break in the oven.</p> <p>METAL TWIST TIES: Remove metal twist ties from plastic or paper bags. They become hot and could cause a fire.</p>

TROUBLE SHOOTING

BEFORE CALLING FOR SERVICE

Check the following list to be sure a service call is really necessary. A quick reference of this manual as well as reviewing additional information on items to check may prevent an unneeded service call.

If nothing on the oven operates:

- check for a blown circuit fuse or a tripped main circuit breaker.
- check if oven is properly connected to electric circuit in house.
- check that controls are set properly.

If the oven interior light does not work:

- the light bulb is loose or defective.

If oven will not cook:

- check that control panel was programmed correctly.
- check that door is firmly closed.
- check that Start Pad was touched.
- check that probe was inserted correctly into receptacle.
- check that timer wasn't started instead of a cook function.

If oven takes longer than normal to cook or cooks too rapidly:

- be sure the Power Level is programmed properly.

If the time of day clock does not always keep correct time:

- check that the power cord is fully inserted into the outlet receptacle.
- be sure the oven is the only appliance on the electrical circuit.

If food cooks unevenly:

- be sure food is evenly shaped.
- be sure food is completely defrosted before cooking.
- check placement of aluminum foil strips used to prevent overcooking.

If food is undercooked:

- check recipe to be sure all directions (amount, time, & power levels) were correctly followed.
- be sure microwave oven is on a separate circuit.
- be sure food is completely defrosted before cooking.

If food is overcooked:

- check recipe to be sure all directions (amount, power level, time, size of dish) were followed.

If arcing (sparks) occur:

- be sure microwavable dishes were used.
- be sure wire twist ties weren't used.
- be sure oven wasn't operated when empty.
- make sure metal rack (if used) is properly installed on 4 supports.

If the Display shows a time counting down but the oven is not cooking:

- check that door is firmly closed.
- check that timer wasn't started instead of a cooking function.

GOLDSTAR MICROWAVE OVENS LIMITED WARRANTY

LG Electronics U.S.A., Inc. will repair or at its option replace, without charge, your product which proves to be defective in material or workmanship under normal use, during the warranty period listed below from the date of original purchase. **This warranty is good only to the original purchaser of the product during the warranty period as long as it is in the U.S. including Alaska, Hawaii, and U.S. Territories.**

WARRANTY PERIOD

<u>LABOR</u>	<u>PARTS</u>	<u>HOW SERVICE IS HANDLED</u>
1 Year	1 Year Magnetron 8 Years	Call 1-800-243-0000, push option #1, 24 hrs. a day, 7 days per week. Please have your product type (Monitor, TV, VCR, MWO) and ZIP code ready. Over 1 Cubic foot, In-Home Service. 1 Cubic Foot and Under, Carry-in Service.

No other express warranty is applicable to this product. **THE DURATION OF ANY IMPLIED WARRANTIES, INCLUDING THE IMPLIED WARRANTY OF MERCHANTABILITY, IS LIMITED TO THE DURATION OF THE EXPRESS WARRANTY HEREIN. LG ELECTRONICS U.S.A., INC. SHALL NOT BE LIABLE FOR THE LOSS OF THE USE OF THE PRODUCT, INCONVENIENCE, LOSS OR ANY OTHER DAMAGES, DIRECT OR CONSEQUENTIAL, ARISING OUT OF THE USE OF, OR INABILITY TO USE, THIS PRODUCT OR FOR ANY BREACH OF ANY EXPRESS OR IMPLIED WARRANTY, INCLUDING THE IMPLIED WARRANTY OF MERCHANTABILITY APPLICABLE TO THIS PRODUCT.**

Some states do not allow the exclusion or limitation of incidental or consequential damages or limitations on how long an implied warranty lasts; so these limitations or exclusions may not apply to you. This warranty gives you specific legal rights and you may also have other rights which vary from state to state.

THE ABOVE WARRANTY DOES NOT APPLY:

- * To damages or problems which result from delivery or improper installation.
- * To damages or problems which result from misuse, abuse, accident, alteration, or incorrect electrical current or voltage.
- * To service calls, which do not involve defective workmanship or material, such as cleaning and explaining the operation of the unit.

Therefore, these costs are paid by the consumer.

CUSTOMER ASSISTANCE NUMBERS:

To Prove Warranty Coverage: → **Retain your Sales Receipt to prove date of purchase.**
→ A copy of your Sales Receipt must be submitted at the time warranty service is provided.

To Obtain Product, Customer, or Service Assistance: Call 1-800-243-0000 (Mon.-Fri. 7a.m.-7p.m. CST)
Push appropriate menu code.

To Obtain Nearest Authorized Service Center: → Call 1-800-243-0000, push option #1, 24 hrs. a day, 7 days per week.
Please have your product type (Monitor, TV, VCR, MWO) and ZIP code ready.

MEMO

MEMO

MEMO



P/NO. 3828W5A0804

Printed in Korea