



Use and Care & Cooking Guide

Spacemaker® Microwave Oven



Safety instructions	3-5
Precautions to Avoid Possible Exposure to Excessive Microwave Energy	2



Operating Instructions, Tips	
Add 30 Seconds	13
Aluminum Foil	4, 18, 24, 26
Auto Defrost	17
Auto Defrost Guide	18
Automatic Fan Feature	5, 7
Auto Roast	19, 20
Auto Simmer	20
Beverage	14
Clock	8
Control Panel	8, 9
Cooking by Temperature	16
Cooking by Time	12, 13
Cooking Complete Reminder	10
Cooking Guide	27
Defrosting by Time	15
Defrosting Guide	26
Delayed Cooking	11
Delay Start/Reminder	13
Exhaust Fan	5, 7, 32
Express Cook Feature	13
Features	10
Glossary of Microwave Terms	24
Heating or Reheating Guide	25
Hold Time	11
Kitchen Timer	11
Microwaving Tips	6
Minute Pad	8
Oven Shelf	4, 5, 10, 14, 22, 24, 28, 29
Popcorn	14, 30
Power Levels 7, 8, 11, 12, 14-16, 25, 26	
Reheat	21
Sensor Cooking	22
(Canned Vegetables, Potatoes, Meats, Frozen Vegetables, Fresh Vegetables, Fish Fillets and Chicken Pieces)	
Sound Level	13
Temperature Probe	4, 8-10, 16, 19, 20



Problem Solver	32
More questions ?...call "GE Answer Center" 800.626.2000	



Care and Cleaning	29-32
Exhaust Fan	31, 32
Grease Filter	31
Light Bulb Replacement	30
Oven Shelf	29
Temperature Probe	29



Installation	31
Adapter Plugs	31
Extension Cords	31
Grounding instructions	31



Consumer Services	35
Appliance Registration	2
Important Phone Numbers	35
Model and Serial Number Location	2
Warranty	Back Cover



JVM260

Microwave power output of this oven is 850 watts



HELP US HELP YOU...

Before using your oven, read this guide carefully.

It is **intended** to help you operate and maintain your new microwave oven properly.

Keep it handy for answers to your questions.

If you don't understand something or need more help, call:

GE Answer Center®
800.626.2000
24 hours a day, 7 days a week

Write down the model and serial numbers.

You'll find them on a label inside the oven.

These numbers are also on the Consumer Product Ownership Registration Card that came with your microwave oven. Before sending in this card, please write these numbers here:

Model Number

Serial Number

Use these numbers in any correspondence or service calls concerning your microwave oven.

Be sure your microwave oven is registered.

It is important that we know the location of your microwave oven should a need occur for adjustments.

Your supplier is responsible for registering you as the owner.

Please check with your supplier to be sure he has done so; also send in your Consumer Product Ownership Registration Card. If you move, or if you are not the original purchaser, please write to us, stating model and serial numbers.

This appliance must be registered. Please be certain that it is.

Write to:

GE Appliances
Range Product Service
Appliance Park
Louisville, KY 40225

If you received a damaged oven...

Immediately contact the dealer (or builder) that sold you the oven.

Save time and money. Before you request service...

Check the Problem Solver in the back of this guide. It lists causes of minor operating problems that you can correct yourself.

All these things are normal with your microwave oven.

- Steam or vapor escaping from around the door.
- Light reflection around door or outer case.
- Dimming oven light and change in blower sound may occur while operating at power levels other than high.
- Dull thumping sound while oven is operating.
- Some TV-Radio interference might be noticed while using your microwave oven. It's similar to the interference caused by other small appliances and does not indicate a problem with your oven.

PRECAUTIONS TO AVOID POSSIBLE EXPOSURE TO EXCESSIVE MICROWAVE ENERGY

- (a) **Do Not Attempt** to operate this oven with the door open since open-door operation can result in harmful exposure to microwave energy. It is important not to defeat or tamper with the safety interlocks.
- (b) **Do Not Place** any object between the oven front face and the door or allow soil or cleaner residue to accumulate on sealing surfaces.
- (c) **Do Not Operate** the oven if it is damaged. It is particularly important that the oven door close properly and that there is no damage to the:
- (1) door (bent)
 - (2) hinges and latches (broken or loosened)
 - (3) door seals and sealing surfaces.
- (d) **The Oven Should Not** be adjusted or repaired by anyone except properly qualified service personnel.

IMPORTANT SAFETY INSTRUCTIONS

Read all instructions before using your appliance.



When using electrical appliances, basic safety precautions should be followed, including the following:

⚠ WARNING—To reduce the risk of burns, electric shock, fire, injury to persons or exposure to excessive microwave energy:

• **Read and follow** the specific “Precautions to Avoid Possible Exposure to Excessive Microwave Energy” on the previous page,

• **This appliance must be grounded.** Connect only to properly grounded outlet. See Grounding Instructions section in the back of this guide.

• **Use this appliance only for its intended use as described in this guide.** Do not use corrosive chemicals or vapors in this appliance. This microwave oven is specifically designed to heat or cook food, and is not intended for laboratory or industrial use.

• **This over-the-range oven was designed for use over ranges no wider than 42 inches.** It may be installed over both gas and electric cooking equipment.

• **For best operation, plug this appliance into its own electrical outlet, to prevent flickering of lights, blowing of fuse or tripping of circuit breaker.**

• **Do not mount this appliance over a sink. Install or locate this appliance only in accordance with the provided Installation Instructions.**

• **Do not cover or block any openings on the appliance.**

• **Do not store this appliance outdoors.** Do not use this product near water—for example, in a wet basement, near a swimming pool or near a sink.

• **This microwave oven is not approved or tested for marine use.**

• **Do not store anything directly on top of the microwave oven surface when the oven is in operation.**

• **Do not immerse power cord or plug in water.**

• **Keep power cord away from heated surfaces.**

• **Do not let power cord hang over edge of table or counter.**

• **Do not operate this appliance if it has a damaged power cord or plug, if it is not working properly, or if it has been damaged or dropped.**

• **See door surface cleaning instructions in the Care and Cleaning section(s) of this guide.**

• **This appliance should be serviced only by qualified service personnel.** Contact nearest authorized service facility for examination, repair or adjustment.

• **As with any appliance, close supervision is necessary when used by children.**

• **To reduce the risk of fire in the oven cavity:**

—**Do not overcook food.** Carefully attend appliance if paper, plastic or other combustible materials are placed inside the oven to facilitate cooking.

—**Remove wire twist-ties and metal handles from paper or plastic containers before placing them in the oven.**

—**Do not use your microwave oven to dry newspapers.**

—**Do not use recycled paper products.** Recycled paper towels, napkins and waxed paper can contain metal flecks which may cause arcing or ignite. Paper products containing nylon or nylon filaments should be avoided, as they may also ignite.

—**Do not pop popcorn in your microwave oven** unless in a special microwave popcorn accessory or unless you use popcorn labeled for use in microwave ovens.

—**Do not overcook potatoes.** They could dehydrate and catch fire, causing damage to your oven.

—**Do not operate the oven while empty to avoid damage to the oven and the danger of fire.**

If by accident the oven should **run empty** a minute or two, no harm is done. However, try to avoid operating the oven empty at all times—it saves energy and prolongs the life of the oven.

(continued next page)



IMPORTANT SAFETY INSTRUCTIONS

(continued)

—**Do not use the oven for storage purposes.**

Do not leave paper products, cooking utensils or food in the oven when not in use.

—**If materials inside oven should ignite,** keep oven door closed, turn oven off and disconnect power cord, or shut off power at the fuse or circuit breaker panel. If the door is opened, the fire may spread.

•**Some products such as whole eggs and sealed containers—for example,** closed jars—will explode and should not be heated in this microwave oven. Such use of the microwave oven could result in injury.

•**Avoid heating baby food** in glass jars, even with the lid off. Make sure all infant food is thoroughly cooked. Stir food to distribute the heat evenly. Be careful to prevent scalding when warming formula or breast milk. The container may feel cooler than the milk really is. Always test the milk before feeding the baby.

•**Don't defrost frozen beverages in narrow necked bottles** (especially carbonated beverages). Even if the container is opened, pressure can build up. This can cause the container to burst, possibly resulting in injury.

•**Use foil only as directed in this guide.**

TV dinners maybe microwaved in foil trays less than 3/4" high; remove the top foil cover and return the tray to the box. When using foil in the microwave oven, **keep the foil at least 1 inch away from the sides of the oven.**



•**Cookware may become hot** because of heat transferred from the heated food. Pot holders may be needed to handle the cookware.

•**Foods cooked in liquids** (such as pasta) may tend to boil over more rapidly than foods containing less moisture. Should this occur, refer to the Care and Cleaning section(s) for instructions on how to clean the inside of the oven.

•**Thermometer-Do** not use a thermometer in food you are microwaving unless the thermometer is designed or recommended for use in the microwave oven.

•**Remove the temperature probe from the oven when not using it to cook with.** If you leave the probe inside the oven without inserting it in food or liquid and turn on microwave energy, it can create electrical arcing in the oven and damage oven walls.

•**Plastic cookware-Plastic cookware designed for microwave cooking is very useful, but should be used carefully.** Even microwave-safe plastic may not be as tolerant of overcooking conditions as are glass or ceramic materials and may soften or char if subjected to short periods of overcooking. In longer exposures to overcooking, the food and cookware could ignite. For these reasons: 1) Use microwave-safe plastics **only** and use them in strict compliance with the cookware manufacturer's recommendations. 2) Do not subject empty cookware to microwaving. 3) Do not permit children to use plastic cookware without complete supervision.

•**When cooking pork,** follow the directions exactly and always cook the meat to an internal temperature of at least 170°F. This assures that, in the remote possibility that trichina may be present in the meat, it will be killed and meat will be safe to eat.

•**Do not boil eggs in a microwave oven.** Pressure will build up inside egg yolk and will cause it to burst, possibly resulting in injury.



•**Foods with unbroken outer "skin"** such as potatoes, sausages, tomatoes, apples, chicken livers and other giblets, and egg yolks (see previous caution) should be pierced to allow steam to escape during cooking.

•**Not all plastic wrap is suitable for use in microwave ovens.** Check the package for proper use.

•**Spontaneous boiling-Under certain special circumstances,** liquids may start to boil during or shortly after removal from the microwave oven. To prevent burns from splashing liquid, we recommend the following: before removing the container from the oven, allow the container to stand in the oven for 30 to 40 seconds after the oven has shut off. **Do not boil liquids in narrow-necked containers such as soft drink bottles, wine flasks and especially narrow-necked coffee cups.** Even if the container is opened, excessive steam can buildup and cause it to burst or overflow.



• **“Boilable” cooking pouches and tightly closed plastic bags should be slit, pierced or vented as directed by package. If they are not, plastic could burst during or immediately after cooking, possibly resulting in injury.** Also, plastic storage containers should be at least partially uncovered because they form a tight seal. When cooking with containers tightly covered with plastic wrap, remove covering carefully and direct steam away from hands and face.



• **Hot foods and steam can cause burns.** Be careful when opening any containers of hot food, including popcorn bags, cooking pouches and boxes. To prevent possible injury, direct steam away from hands and face.

• Use of the shelf accessory.

- Remove the shelf from oven when not in use.
- Do not store or cook with shelf on floor of oven. Product damage may result.
- Use pot holders when handling the shelf and cookware. They may be hot.
- Do not use microwave browning dish on shelf. The shelf could overheat.
- Use the shelf only when cooking on 2 levels.
- Be sure that the shelf is positioned properly inside the oven to prevent product damage. Use of shelf with Sensor Cooking or Reheat is not recommended. Do NOT use the metal shelf with the Popcorn program (see the Sensor Cooking, Reheat or Popcorn sections).

The Exhaust Hood

• **Have it installed and properly grounded by a qualified installer. See the special installation booklet packed with the microwave oven.**

• **The exhaust fan in the oven will operate automatically under certain conditions (see Automatic Fan Feature). While the fan is operating, caution is required to prevent the starting and spreading of accidental cooking fires while the exhaust fan is in use. For this reason:**

— **Never leave surface units unattended at high heat settings. Boilovers cause smoking and greasy spillovers that may ignite and spread if exhaust fan is operating. To minimize automatic fan operation, use adequate sized cookware and use high heat only when necessary.**



— **In the event of a grease fire, smother flaming pan on surface unit by covering pan completely with well-fitting lid, cookie sheet or flat tray.**

- **Clean the vent hood often. Do not allow grease to buildup on the hood or the filter.**
- **Use care when cleaning the vent hood filter. Corrosive cleaning agents, such as lye-based oven cleaners, may damage the filter.**
- **When flaming foods are under the hood, turn the fan off. The fan, if operating, may spread the flame.**

SAVE THESE INSTRUCTIONS

Optional Accessories

Available at extra cost from your GE supplier.

JX40AL Filler Panel Kit (for model JVM260AV).

JX40WH Filler Panel Kit (for model JVM260WV).

JX41 Filler Panel Kit (for model JVM260BV).

JX50 Glass Canopy Kit

JX81A Charcoal Filter Kit for non-vented installation.

This microwave oven is UL listed for installation over electric and gas ranges.

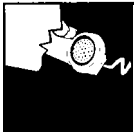

IF YOU NEED SERVICE...

To obtain service, see the Consumer Services page in the back of this guide.

We're proud of our service and want you to be pleased. If for some reason you are not happy with the service you receive, here are 3 steps to follow for further help.

FIRST, contact the people who serviced your appliance. Explain why you are not pleased. In most cases, this will solve the problem.

NEXT, if you are still not pleased, write all the details—including your phone number—to:

Manager, Consumer Relations
GE Appliances
Appliance Park
Louisville, KY 40225

FINALLY, if your problem is still not resolved, write:

Major Appliance Consumer Action Panel
20 North Wacker Drive
Chicago, IL 60606



MICROWAVING TIPS

• **Make sure all cookware used in your microwave oven is suitable for microwaving.** Most glass casseroles, cooking dishes, measuring cups, custard cups, pottery or china dinnerware which does not have metallic trim or glaze with a metallic sheen can be used. Some cookware is labeled "suitable for microwaving."

• **If you are not sure if a dish is microwave-safe, use this test:** Place in the oven both the dish you are testing and a glass measuring cup filled with 1 cup of

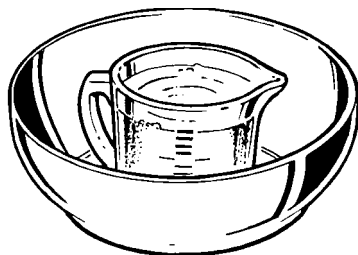

water—set the measuring cup either in or next to the dish. Microwave 1 minute at high. If the dish heats, it should not be used for microwaving. If the dish remains cool and only the water in the cup heats, then the dish is microwave-safe.

• **Paper towels, waxed paper and plastic wrap** can be used to cover dishes in order to retain moisture and prevent spattering. Be sure to vent plastic wrap so steam can escape.

• **Some microwaved foods require stirring, rotating or rearranging.** Check the Cooking Guide.



• **Steam builds up pressure in foods which are tightly covered by a skin or membrane.** Pierce potatoes, egg yolks and chicken livers to prevent bursting.

If you use a meat thermometer while cooking, make sure it is safe for use in microwave ovens.

VARIABLE POWER LEVELS (1-10)

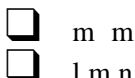

How to Change Power Level

1. Press MICRO COOK or TIME DEFROST.
2. Select cooking or defrosting time. 
3. Press POWER LEVEL. 
4. Select desired power level 1-10.  m m
l m n
5. Press START.

Variable power levels add flexibility to your microwave cooking. The power levels on your microwave oven can be compared to the surface units on a range. High (Power Level 10) or full power is the fastest way to cook and gives you 100%J power. Each power level gives you microwave energy a certain percent of the time. Power Level 7 is microwave energy 70% of the time. Power Level 3 is energy 30% of the time.

A high setting (10) will cook faster but may need additional attention such as frequent stirring, rotating or turning over. Most of your cooking will be done on High (Power Level 10). A lower setting will cook more evenly and with less attention given to stirring or rotating the food. Some foods may have better flavor, texture or appearance if one of the lower settings is used. You may wish to use a lower power level when cooking foods that have a tendency to boil over, such as scalloped potatoes.

Rest periods (when the microwave energy cycles off) give time for the food to “equalize” or transfer heat to the inside of the food. An example of this is shown with Power Level 3—the defrost cycle. If microwave energy did not cycle off, the outside of the food would cook before the inside was defrosted.

Here are some examples of uses for various power levels:

POWER LEVEL	BEST USES
High 10	Fish, bacon, vegetables, boiling liquids.
Med-High 7	Gentle cooking of meat and poultry; baking casseroles and reheating.
Medium 5	Slow cooking and tenderizing such as stews and less tender cuts of meat.
Low 3	Defrosting without cooking; simmering; delicate sauces.
Warm 1	Keeping food warm without overcooking; softening butter.

AUTOMATIC FAN FEATURE

This microwave oven has an automatic fan feature to protect it from too much heat rising from the cooktop or range beneath it. It automatically turns on at a low speed if it senses too much heat.

If you have turned the fan on you may find that you cannot turn it off. This is because the automatic fan has come onto protect the internal parts of the microwave.

The fan will automatically turn off when the internal parts are cool. It may stay on for 30 minutes or more after the range and microwave controls have been turned off.



YOUR TOUCH CONTROL PANEL

The Touch Control Panel allows you to set the oven controls with the touch of a finger. It's designed to be easy to use and understand.

1. **DISPLAY.** Displays time of day, time or temperature during cooking functions, power level being used, cooking mode and instructions.
2. **CANNED VEG, POTATOES, MEAT, FROZEN VEG, FRESH VEG, FISH FILLETS AND CHICKEN PIECES.** Touch one of these pads for programming the oven to automatically cook the specific food. The oven automatically microwaves at pre-programmed power levels and determines the proper amount of cooking times until the food is done and oven shuts off.
3. **POPCORN.** Touch this pad to cook prepackaged microwave popcorn weighing 3.0 to 3.5 ounces. No need to touch START, the oven will start immediately.
4. **BEVERAGE.** Touch this pad to heat or reheat a beverage. No need to touch START, the oven will start immediately.
5. **REHEAT.** Touch this pad for quick reheating of prepared foods. No need to touch START, the oven will start immediately.
6. **MICRO COOK.** Microwave for a selected amount of time using automatic Power Level 10 (High).
7. **TIME DEFROST.** Gentle thawing at automatic Power Level 3 (Low).
8. **EXPRESS COOK.** Touch number pads 1 through 5 for 1 to 5 minutes of cooking. No need to touch START, the oven will start immediately.
9. **NUMBER PADS.** Touch these pads to program the microwave.
10. **POWER LEVEL.** Touch this pad before entering another power level number if you want to change from automatic Power Level 10 (High) for cooking or Power Level 3 (Low) for defrosting.
11. **CLOCK DISPLAY ON/OFF.** Touch the 0 number pad to turn the clock display on or off. The Clock Display On/Off feature cannot be used while a cooking feature is in use.
12. **SOUND LEVEL.** Press the SOUND LEVEL pad. Press number pad 0, 1, 2 or 3, then press START pad to change the sound level of the oven beeper.
13. **KITCHEN TIMER.** This feature uses no microwave energy. It functions as either a kitchen timer, as a holding period after defrost or as a delay timer before time or temperature cooking.
14. **CLOCK.** Touch this pad to enter time of day or check time of day while microwaving. To set clock, first touch CLOCK pad and then enter time of day. For example, if time is 1:30, touch number pads 1, 3 and 0 and "1:30" will appear in display. Then touch START or CLOCK pad. To reset or change time, simply repeat above process.
15. **AUTO DEFROST.** Touch this pad and food weight, then START. The oven automatically sets power levels and defrosting time.
16. **AUTO ROAST.** Insert probe. Touch this pad, the desired number pad for the code, then START. The oven slow-cooks meat with the automatic preset program.
17. **TEMP COOK/HOLD.** Use the temperature probe to cook by using a preset temperature. Once food reaches preset temperature, oven switches to HOLD setting and maintains that temperature until you touch the CLEAR/OFF pad.
- 17.3. **DELAY START/REMINDER.** Allows you to program your oven to begin cooking at a preset time of day—up to a 12-hour delay. The Reminder feature can be used like an alarm clock.
19. **START.** After all selections are made, touch this pad to start the oven.
20. **MINUTE.** Use this with number pads to enter whole minutes. For example, for 4 minutes touch 4 and MINUTE.
21. **CLEAR/OFF.** When touched, it shuts off the oven and erases all settings (except time of day). When held for **three seconds, the Child Lock-Out feature will be activated. To deactivate, press and hold CLEAR/OFF pad for three seconds.**
22. **ADD 30 SEC.** Press this pad for 30 seconds cook time, to add 30 seconds to the cook time as it's counting down or for an "instant on" for 30 seconds.
23. **NIGHT LIGHT.** Touch to turn on night light.
24. **SURFACE LIGHT.** Touch to turn on surface light.
25. **VENT FAN.** Press once for LOW, again for HIGH and again for OFF.

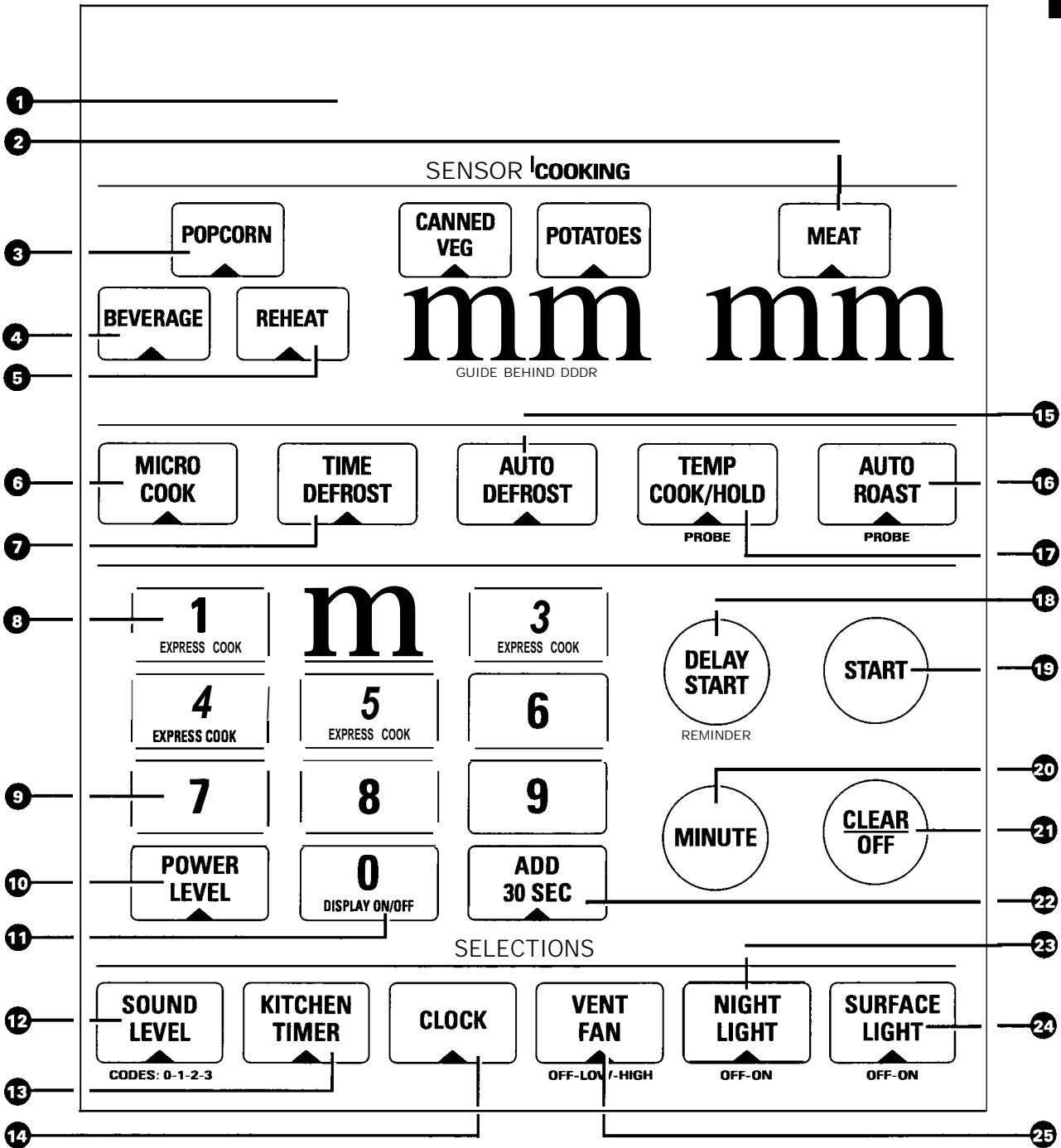

Your Touch Control Panel

When You Plug in the Oven

The display panel displays “88888”, “18 POWER” and all of the oven functions. After 15 seconds, all lights disappear and “RESET” appears in the upper portion. Touch the CLEAR/OFF pad, set the Clock and oven is ready for use.

This will happen any time there is a power outage.

“PROBE” Appears on the Display:

- Probe has been forgotten when Auto Roast or Temp Cook/Hold function is being used.
- Probe is not securely seated in oven wall receptacle.



FEATURES OF YOUR OVEN

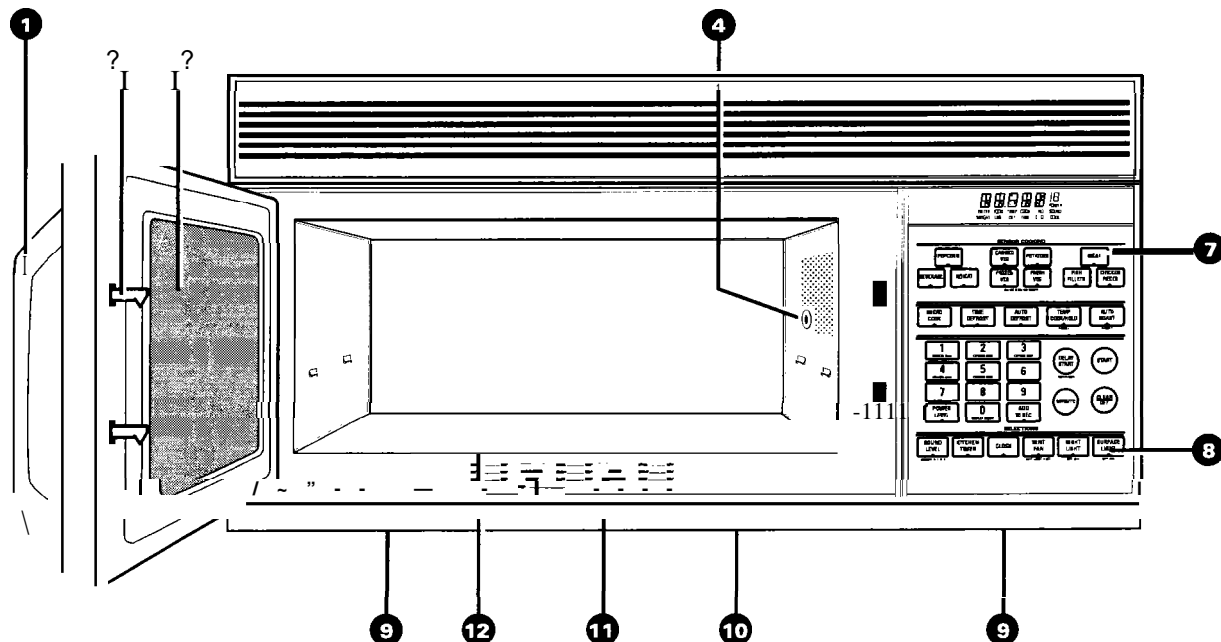
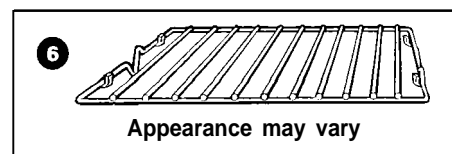
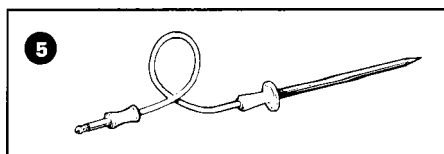

1. **Door Handle.** Pull to open door. Door must be securely latched for oven to operate.
2. Door Latches.
3. Window with Metal Shield. Screen allows cooking to be viewed while keeping microwaves confined in oven.
4. **Receptacle for Temperature Probe.** Probe must be securely inserted into receptacle before oven will start any temperature or Auto Roast cooking.
5. **Temperature Probe.** Use with Temp Cook/Hold and Auto Roast functions only.
6. Shelf. Lets you microwave several foods at once. Food microwaves best when placed directly on the oven floor. Use this shelf only when cooking foods on 2 levels. (See Safety Instructions and Oven Shelf section for special instructions.)

7. Touch Control Panel and **Digital Display.** For detailed information on each feature, see Your Touch Control Panel section.
8. **Hood Controls.**
Vent Fan. Press once for LOW, again for HIGH and again for OFF.
Surface Light.
Night Light.
9. **Grease Filters.**
10. **Cooktop Light.**
11. **Automatic Cooking Guide.**
12. **Oven Floor.**

NOTE: Rating plate, oven vent(s) and oven light are located on the inside walls of the microwave oven.

Cooking Complete Reminder (For all cooking features except Temp Cook/Hold and Auto Roast code 4)

To remind you that you have food in the oven, the oven will display "End" and beep once a minute until you either open the oven door or touch the CLEAR/OFF pad.

This is to certify that this unit has been tested in conformance with AMCA Bulletin No. 210.

C.F.M.
at 0.10 WG
300 Vert.
300 Her.

SONES
7.2 Vert.
6.8 Her.

HOW TO USE THE KITCHEN TIMER



The Kitchen Timer

The Kitchen Timer has 3 timing functions:

- It operates as a minute timer.
- It can be set to delay cooking.
- It can be used as a hold setting after defrosting.

The Kitchen Timer operates without microwave energy.

Using a Holding Time

The Kitchen Timer can also be used to program a “holding time” between microwave cooking functions. The time can range from 1 second to 99 minutes and 99 seconds. A holding or standing time maybe found in some of your own recipes or in a cookbook.

How to Time a 3-Minute Phone Call

Step 1: Touch KITCHEN TIMER pad.

Step 2: Touch number pad 3 and MINUTE pad (for 3 minutes and no seconds).

Step 3: Touch START. Display shows time counting down. The timer signals when time is up.

Programming Delayed Cooking

To delay cooking up to 99 minutes and 99 seconds, touch either MICRO COOK, TEMP COOK/HOLD or AUTO ROAST and enter cook time, temperature or code. Touch KITCHEN TIMER and enter number of minutes to delay cooking. **When delaying Temp Cook/Hold or Auto Roast cooking, be sure probe is in food.** Touch START. Timer will count down to zero and cooking will begin.

How to Defrost, Hold and Micro Cook

Let's say you want to defrost a frozen casserole for 15 minutes, hold for 10 minutes and then Micro Cook for 25 minutes. Here's how to do it:

Step 1: Take casserole from freezer and place in oven.



Step 2: Touch TIME DEFROST pad.

Step 3: Touch pads 1, 5 and MINUTE for 15 minutes defrosting time. (Defrosting is automatically set on power level 3 but can be changed by touching the POWER LEVEL pad and the desired power level 1-10.)



Step 4: Set standing or hold time by touching KITCHEN TIMER pad.

Step 5: Touch 1,0 and MINUTE to hold for 10 minutes.



Step 6: Touch MICRO COOK pad.

Step 7: Touch 2,5 and MINUTE for 25 minutes of cooking time.



Step 8: Touch START. As each function is automatically performed, oven display shows instructions entered and the function. When time is up, the oven signals and flashes “End.”

CHILD LOCK-OUT

You may lock the control panel to prevent the microwave from being accidentally started or used by children.

To lock the controls press and hold the CLEAR/OFF pad for about three seconds. The display will show LOCK and then return to the time of day. A small “L” will be displayed to remind you that the control panel is locked.

If anyone tries to use the microwave, the display will show LOCK.

To unlock the control panel press and hold the CLEAR/OFF pad for about three seconds.

The display will show the time of day.



COOKING BY TIME

Micro Cook I

Micro Cook allows you to microwave for a preset amount of time.

Power Level 10 (High) is recommended for most cooking, but you may change this for more flexibility. See the Cooking Guide.

To become better acquainted with time cooking, make a cup of coffee by following the steps below.

Step 1: Fill a cup 2/3 full of water, add 1 teaspoon of instant coffee and stir to dissolve.

Use a cup that has no metal decoration and is microwave-safe (refer to

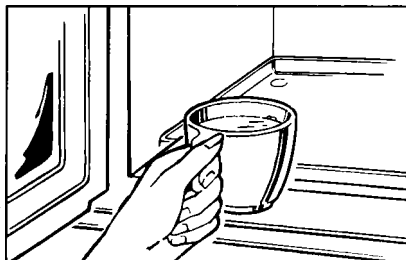

Microwaving Tips section).

Place cup in oven and close door.



Step 2: Touch MICRO COOK.

Step 3: Select your time. Touch pad 1 and MINUTE pad for 1 minute.

Because automatic Power Level 10 is recommended for this cup of coffee, there is no need to change the power level. (If Power Level 10 is not appropriate, see “How to Change Power Level” below.)

Step 4: Touch START.



Step 5: When time is up, the oven signals and flashes “End”. The oven, light and fan shut off.

Step 6: Open the door.

If you interrupt Micro Cook to check the food, simply close the door and press START to resume cooking. “ If there is not time remaining on the timer you must reset the timer to resume cooking.

How to Change Power Level When Setting Micro Cook I

1. Press MICRO COOK.

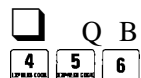

2. Select cooking time.

3. Press POWER LEVEL.

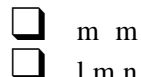

4. Select desired power level 1–10.

5. Press START.

Using the Micro Cook II Feature

The Micro Cook II feature lets you set 2 time cooking functions within one program. This is ideal if you want to change power levels during your cooking operations. Here’s how to do it.

Step 1: Place the food in the oven in a microwave-safe container and close the door.



Step 2: Touch MICRO COOK.

Step 3: Select your first cook time. For example, touch 2, 1 and 5 for 2 minutes and 15 seconds.

Step 4: Now is the time to change the power level if you don’t want full power for MICRO COOK. (Press POWER LEVEL. Select desired power level 1–10.)

Step 5: Touch MICRO COOK again.

Step 6: Set your second cook time.

Step 7: Change the power level for MICRO COOK. (Press POWER LEVEL. Select desired power level 1-10.)



Step 8: Press START.

The microwave oven will start and the time set for “COOK TIME I” will count down. Also, “POWER 10” or the power level selected for “COOK TIME I” will be displayed.

At the end of “COOK TIME I”, the second power level is displayed and the time for “COOK TIME II” is shown counting down.

When time is up, the oven signals and flashes “End”. The oven, light and fan shut off. Open the door.

If you interrupt Micro Cook to check the food, simply close the door and press START to resume cooking. If there is no time remaining on the timer you must reset the timer to resume cooking.



The Express Cook Feature

The Express Cook feature is a short-cut method to set time for 1-5 minutes at Power Level 10.

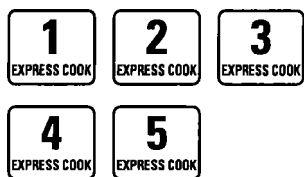

To Express Cook your food or beverage:

Touch a number pad (from 1 to 5) for 1 to 5 minutes of cooking at Power Level 10. For example, touch the 2 pad for 2 minutes of cooking time. No need to touch START, the oven will start immediately.

The oven will signal and turn off automatically when finished.

How to Use Delay Start

The Delay Start feature allows you to program your oven to begin cooking at a preset time of day—up to a 12-hour delay.



Step 1: Touch DELAY START pad.

Step 2: Enter the time you want the oven to start. (Be sure your microwave oven clock shows the correct time of day.)

Step 3: Enter your desired cooking program.



Step 4: Touch START pad. The display will show the time you entered. The time of day may be displayed by touching the CLOCK pad. The oven will automatically start at the desired time.

How to Use Reminder

The Reminder feature can be used like an alarm clock, without starting the oven.

Example: It is 7 a.m. and you must remember to leave for a dentist appointment at 10 a.m.



Step 1: Touch DELAY START pad.

Step 2: Enter the time you want the oven to remind you. (Be sure your microwave oven clock shows the correct time of day. The reminder time can be set up to 12 hours later.)

Step 3: Touch START pad. The reminder is now set at the time you programmed, and will signal you at that time with a beeping sound until

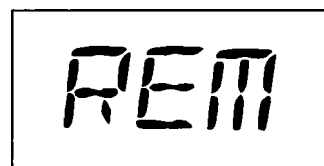

you open the door or touch the CLEAR/OFF pad. The display will show “REM” until the oven door is opened or CLEAR/OFF is touched. The REMinder time may be displayed by touching the DELAY START pad. The time-of-day may be displayed by touching the CLOCK pad.

The Sound Level Feature

The Sound Level Feature lets you change the sound level of the oven beeper. To set the beeper sound level:

Step 1: Touch the SOUND LEVEL pad.

Step 2: Touch O for No Sound, 1 for Soft, 2 for Normal or 3 for Loud. When you touch each number pad the oven will beep at the volume that you have selected.

Step 3: When you have selected your desired sound level, touch the START pad.

Add 30 Seconds

The Add 30 Seconds feature provides a convenient way to extend cooking time by 30 seconds while the oven timer is counting down. It will add 30 seconds to the time shown each time the pad is touched.

This pad may also be used as an express cook for 30 seconds of cooking. No need to touch START, the oven will start immediately.



POPCORN

NOTE: Do NOT use the metal shelf with the Popcorn program.

The Popcorn feature is designed to be used only with prepackaged microwave popcorn weighing 3.0 to 3.5 ounces.

Step 1: Remove the outer wrapper from the microwave popcorn.

Step 2: Open oven door and place package of popcorn in the center of the oven floor as directed by the package instructions. Close oven door.



Step 3: Touch POPCORN pad. No need to touch START, the oven will start immediately.

After the popcorn sensor detects steam, the oven signals and displays remaining cooking time needed.

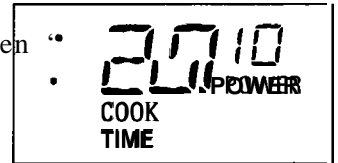

Step 4: When cooking is completed, the oven signals and flashes “End”. Open the door and remove the popcorn.

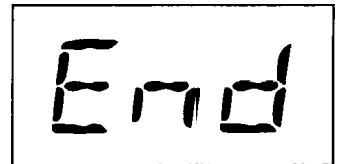

How to Adjust the Popcorn Program to Provide a Shorter or Longer Cook Time

If your favorite popcorn is not completely popped, there is a simple adjustment you can make.

Touch the POPCORN pad. (The oven will start immediately.) Then touch number pad 9. A plus sign will appear on the display beside the word “POP”.

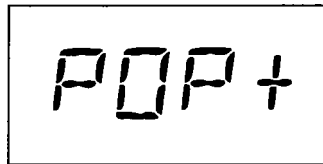

The plus sign indicates 20 seconds more cooking time is being provided.

If your favorite popcorn is overcooked, there is a simple adjustment you can make.

Touch the POPCORN pad. (The oven will start immediately.) Then touch number pad 1. A minus sign will appear on the display beside the word “POP”.

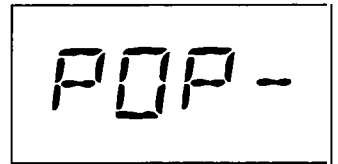

The minus sign indicates 20 seconds less cooking time is being provided.

Questions and Answers

Q. I opened the door to check on the popcorn and “Error” appeared on the display. Why?

A. The Popcorn program first detects steam and then switches to Micro Cook. If you open the door while “POP” is displayed, “Error” will appear. Close the door, touch CLEAR/OFF and begin again. You may open the door when “End” appears on display.

Q. Can I use regular popcorn with the Popcorn feature in my microwave oven?

A. No. This automatic function is designed to be used only with prepackaged microwave popcorn.

BEVERAGE

The Beverage program makes it simple to heat a cup of hot chocolate or other beverage. Use a cup that has no metal decoration and is microwave-safe (refer to the Microwaving Tips section).



Touch BEVERAGE pad. No need to touch START. The oven will start immediately.

The oven will signal and turn off automatically when finished.

CAUTION: Beverages heated with the Beverage feature may be quite hot. Remove the container with care.

DEFROSTING BY TIME



Time Defrost (Power Level 3)

Time Defrost is designed for speedy thawing of frozen food and is one of the great advantages of a microwave oven.

Use the Time Defrost setting to quickly thaw foods such as bread, rolls, vegetables, fruits and frozen dinners. The Auto Defrost setting is preferred for meat and poultry because the oven sets the defrosting time and power levels for you.

- Power Level 3 is automatically set when you press TIME DEFROST pad, but you may change this for more flexibility.
- See the Defrosting Guide for defrosting help.

How to Change Power Level

- | | | |
|-------------------------------------|--------------------------|-------|
| 1. Press TIME DEFROST. | <input type="checkbox"/> | D B |
| 2. Select defrosting time. | <input type="checkbox"/> | B m |
| 3. Press POWER LEVEL. | <input type="checkbox"/> | m m |
| 4. Select desired power level 1-10. | <input type="checkbox"/> | m c l |
| 5. Press START. | | |

To become better acquainted with the defrost function, defrost a 10 oz. package of frozen strawberries by following the steps below.

Step 1: Place a package of frozen strawberries in the oven and close door. Be sure package contains no metal.



Step 2: Touch TIME DEFROST.

Step 3: Select one half of the total defrosting time recommended. For example, touch pads 4, 0 and 0 for 4 minutes.



Step 4: Touch START. When the cycle is completed, the oven signals and flashes "End", then automatically shuts off.

Step 5: Turn the package over, close the door and repeat Steps 2 and 3 to set remaining half of defrosting time. Touch START.

Step 6: When the oven signals and flashes "End", open the door, remove the package and separate strawberries to finish defrosting.

Defrosting Tips



- Foods frozen in paper or plastic can be defrosted in the package. Tightly closed packages should be slit, pierced or vented, AFTER food has partially defrosted, as directed by package. Plastic storage containers should be at least partially uncovered.

- Family-size, pre-packaged frozen dinners can be defrosted and microwaved. If the food is in a foil container, transfer it to a microwave-safe dish.



- For even defrosting, some foods need to be broken up or separated part of the way through the defrosting time.
- Foods that spoil easily, such as milk, eggs, fish, stuffings, poultry and pork should not be allowed to sit out for more than one hour after defrosting. Room temperature promotes the growth of harmful bacteria.
- Check the Defrosting Guide for other defrosting tips.

Questions and Answers

Q. When I press START, I hear a dull thumping noise. What is it?

A. This sound is normal. It is letting you know the magnetron is in operation.

Q. Can I defrost small items in a hurry?

A. Yes, but they will need more frequent attention than usual. Raise the power level after entering the time by touching the desired power level pad. Power Level 7 cuts the total defrosting time in about 1/2; Power Level 10 cuts the total defrosting time to approximately 1/3. During either, rotate or stir food frequently.



COOKING BY TEMPERATURE

Internal temperature is the best test of doneness for many foods.

Use **Temp** Cook/Hold to cook a variety of foods to the desired finished food temperature. The Micro Cook setting is recommended for batters, doughs, frozen foods and foods which are **difficult** to cook precisely with the probe.

Temp Cook/Hold takes the guesswork out of cooking, because the oven automatically switches to “Hold” setting after reaching the preset food temperature and maintains that temperature until you touch the CLEAR/OFF pad.

NOTE: Oven automatically switches to “Hold” when preset food temperature is reached.

The Temperature Probe

The temperature probe is a food thermometer that gauges the internal temperature of your food. (Its appearance may vary from picture shown.) The probe must be used when using Temp Cook/Hold or Auto Roast. To use the probe properly, follow directions in the Automatic Roasting section.

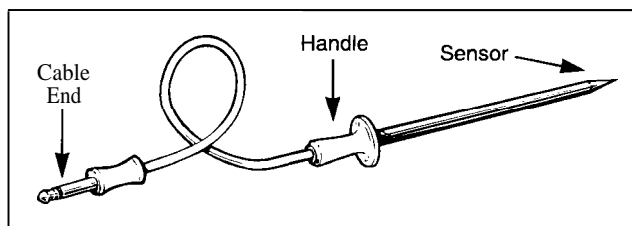

How to Temp Cook a Rolled Beef Rib Roast to Medium

Step 1: Insert temperature probe and attach probe securely in oven wall. Close the door.

Step 2: Touch TEMP COOK/HOLD pad.

Step 3: Touch 1,6 and O for 160°F.

Step 4: Touch POWER LEVEL pad. Touch 5 for medium power.

Step 5: Touch the START pad. If internal temperature of the roast is less than 90°F, display will show “COOL”; if temperature is 90°F or above, display shows temperature counting up.

Step 6: When 160°F is reached, the oven will sound and display “Hold.” The oven will then hold the temperature.

Step 7: Touch the CLEAR/OFF pad to stop the cycle.

Step 8: Remove probe and food from the oven.

Cooking Tips

- Use a lower power level; foods will heat more evenly though requiring more time.
- Be sure frozen food has been completely defrosted before inserting probe. Probe may break off if used in frozen foods.

- Cover foods loosely for moisture control and quick, even heating.
- Insert the probe horizontally into the center meaty area not touching bone or fat. Make sure the handle does not touch the food or top or sides of the oven.

Questions and Answers

Q. Why did “PROBE” flash on the display?

A. “PROBE” will flash if you don’t seat the cable end of the probe securely into the receptacle in the oven wall or if you touch the TEMP COOK/HOLD pad and forget to use the probe.

Q. Can I leave my probe in the oven if it’s not inserted in food?

A. No, if it touches the oven wall, it may damage the oven.

AUTO DEFROST



Auto Defrost

With the Auto Defrost feature, the oven automatically sets the defrosting times and power levels for you.

Use the Auto Defrost Guide. Enter the food weight in pounds and tenths of a pound (see Conversion Guide below). Then touch START pad.

The oven calculates defrosting time and changes power levels during defrosting to give even defrosting results.

How to Set Auto Defrost

Before you begin, check the guide located on the inside front of oven when you open the door.

It shows minimum and maximum food weights for a variety of foods. You will need to know your food weight before setting Auto Defrost.

Step 1: Remove food from package, place in oven on microwave-safe dish and close door.

Step 2: Touch AUTO DEFROST pad.



Step 3: Enter weight. For example, touch number pads 1 and 2 for weight of 1.2 pounds (1 pound, 3 ounces). See Conversion Guide below. After approximately 5 seconds “START” flashes.



Step 4: Touch START pad. Display shows defrost time counting down.

Twice during defrosting, the oven beeps 4 times and “TURN” flashes. Follow the directions in the Auto Defrost Guide for what to do at the first and second signal. Then close the door and touch START pad.

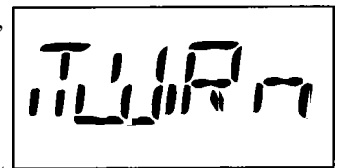

When defrosting time is completed, “End” flashes and oven beeps 4 times. “End” remains on display and oven beeps every minute until door is opened or CLEAR/OFF pad is touched.

Stand Time

After Auto Defrosting, meat needs to stand in order to let the inside defrost. You may take the food out of the oven if you wish. Stand time recommendations are given in the Auto Defrost Guide.

Conversion Guide

If the weight of food is stated in pounds and ounces, the ounces must be converted to tenths (.1) of a pound.

Ounces	Pounds
1-2	.1
3	.2
4-5	.3
6-7	.4
8	.5
9-10	.6
11	.7
12-13	.8
14-15	.9



AUTO DEFROST GUIDE

RECOMMENDED FOODS	MIN.-MAX. WEIGHT	FIRST SIGNAL	SECOND SIGNAL	STAND TIME
Chops	0.1 -6.0 lbs.	Turn over.	Separate and shield where necessary.	5 minutes
Frankfurters, Sausage	0.1 -6.0 lbs.	Separate.	Remove defrosted pieces.	2 minutes
Ground Meat	0.1 -6.0 lbs.	Turn over.	Remove defrosted areas and break apart.	5 minutes
Beef Patties	0.1 - 6.0 lbs.	Turn over.	Separate patties.	5 minutes
Roast	0.1 -6.0 lbs.	Turn over and shield.	Shield if necessary.	30 minutes
Ribs	0.1 -6.0 lbs.	Turn over.	Remove defrosted pieces. Shield if necessary.	5 minutes
Steak	0.1 -6.0 lbs.	Turn over.		5 minutes
Stew	0.1 -6.0 lbs.	Turn over and separate.	Separate and remove defrosted pieces.	5 minutes
Whole Chicken	0.1 -6.0 lbs.	Turn over and shield.	Turn over and shield.	10 minutes; run cold water in cavity.
Turkey Breast (breast side up)	0.1 -6.0 lbs.	Turn over.	Shield where necessary.	20 minutes; run cold water in cavity.
Chicken Pieces	0.1 -6.0 lbs.	Turn over.	Separate and remove defrosted pieces.	5 minutes
Cornish Hens (whole)	0.1 -6.0 lbs.	Remove wrapper and turn over.		10 minutes; run cold water in cavity.
Cornish Hens (split)	0.1 -6.0 lbs.	Turn over.		5 minutes
Fish Fillets	0.1 -6.0 lbs.	Turn over.	Separate and remove defrosted pieces.	5 minutes
Shrimp, Scallops	0.1 -6.0 lbs.	Separate.	Separate and remove defrosted pieces.	5 minutes
Whole Fish	0.1 -6.0 lbs.	Turn over and shield tail and head.		Hold under cold running water.

Edges or thin areas of meat will defrost more rapidly than other areas.
After first or second signal, shield warm areas with small pieces of foil.

AUTOMATIC ROASTING



Auto Roast uses the temperature probe to cook to the desired serving temperature. Unlike Temp Cook/Hold, which uses a single power level, Auto Roast uses up to 3 power settings which automatically switch during roasting, thus providing even, tender cooking results without overcooking.

Just as in regular roasting, only tender roasts should be roasted until specified internal temperatures are reached. Less tender roasts should be microwaved by time.

Preparing Roasts for Auto Roasting

Place tender beef roast in cooking bag on trivet in microwave-safe dish. (Refer to package instructions for proper use of cooking bag.) Insert probe through cooking bag horizontally into the center meaty area not touching bone or fat. Make sure the handle does not touch the food or top or sides of the oven.

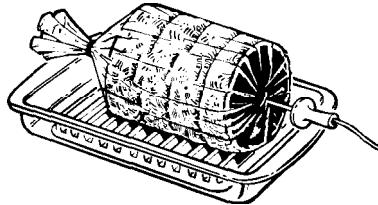

Place pork roast in cooking bag and place in microwave-safe dish.

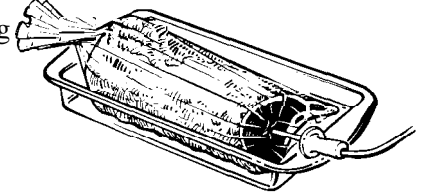

Place meat in oven with probe to the right. Insert cable end of probe firmly into receptacle on oven wall.



How to Roast Beef to Medium

Step 1: Touch AUTO ROAST pad. Touch number pad 1. Touch START. (See the Auto Roast Guide for complete list of recommended codes.)

NOTE: By touching the AUTO ROAST pad during cooking, the meat's internal temperature will be displayed. ("COOL" will be displayed until meat reaches 90°F.) When pad is released, doneness code reappears on the display.



Step 2: When you select Auto Roast codes 1 or 2, the oven signals with 4 beeps and "TURN" flashes on the display when it's time to turn the roast over. After you turn the roast, close the door and touch START. (**NOTE:** Oven continues to cook after the signal whether or not roast is turned over.)

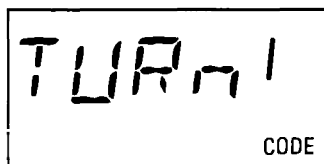

Step 3: After a pre-programmed food temperature is reached, oven beeps 4 times and "HOLD" appears on the display.

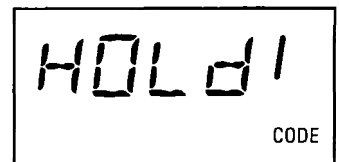

Step 4: Food will be held at this temperature for 60 minutes. The oven then beeps 4 times and "End" appears.

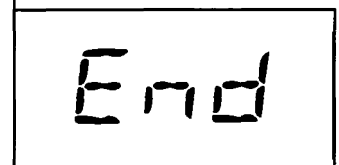

(continued next page)



AUTOMATIC ROASTING

(continued)

Auto Roast Guide

•Place meats in a cooking bag in microwave-safe dish. (Refer to package instructions for proper use of cooking bag.)

•Insert probe as described in the Automatic Roasting section.

Food	Code	Minimum End Temp.	Approx. Time (minutes per pound)	Hold* Minutes	Doneness Display
Beef (5 lb. max.) Tender Roast Medium Well	1 2	160°F. 170°F.	15-23 23-30	0 5-10	MEd WELL
Pork (5 lb. max.) Loin Roast	2	170°F.	23-30	10	WELL
Poultry (6 lb. max.) Turkey Breast (Insert probe horizontally into meatiest area.)	3	185°F.	16-19	10-15	WELL

*Recommended standing time before serving.

Automatic Simmer (Auto Roast Code 4)

Total time includes time to bring food to 180°F., and hold at that temperature until done.

Set Auto Simmer like Auto Roast as explained in the Automatic Roasting section. Display shows "SIM" and "CODE 4."

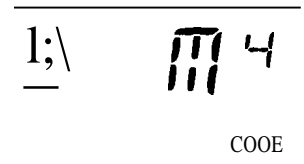

Oven switches to Hold at 180°F., and continues holding at 180°F. until you remove food and touch CLEAR/OFF pad. If stirring is recommended, you can restart oven by touching the START pad again. Touch CLEAR/OFF pad to turn oven off.

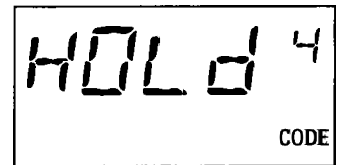

Automatic Simmer Guide (Auto Roast Code 4)

Food	Final Temp.	Approx. Time/Hours	Doneness Display	Comments
Beef Pot Roast	180°F.	5-7	SIM	Add enough liquid to just cover meat. If adding vegetables, make sure they are completely covered by liquid. Precook meat. Place probe 1 inch from top surface. Stir after 3 hours, if possible.
Chili	180°F.	5-8	SIM	
Chicken Stewing	180°F.	4-6	SIM	Add 4 cups liquid. Insert probe into meatiest area of inner thigh from below end and parallel to leg. Turn over after 1/2 of time. Same procedure as above.
Broiler/Fryer	180°F.	3-4	SIM	
Ham/Pork Roast	180°F.	4-6	SIM	Add 4 cups liquid.
soup Stock/Vegetable	180°F.	7-10	SIM	Make sure that vegetables and meat are covered by liquid. Stir every 3 hours. Add enough liquid to cover peas at least 2 inches. Stir after 3 hours.
Split Pea	180°F.	5-7	SIM	

REHEAT



Reheat is designed for reheating single serving sizes of previously prepared foods. With many leftovers, there is no need to look up reheating times in a cookbook or to rely on guesswork.

By actually sensing the steam that escapes as food heats, this feature automatically adjusts the oven's heating time to various types and amounts of pre-cooked food.

Because all cooking containers must be covered during automatic reheating, this feature is best with foods you want to steam or retain moisture.

NOTE: Do NOT use the metal shelf with sensor Reheat.

Foods Recommended

A wide variety of previously prepared foods including leftovers can be reheated using this feature. Reheat is recommended for single-servings of food or plates of leftovers.

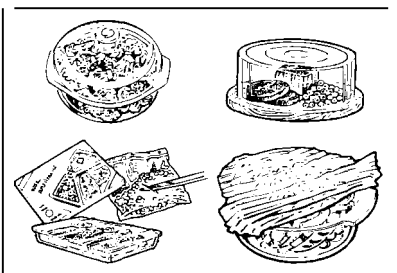

Foods Not Recommended

Bread products, foods that must be reheated uncovered, foods that require constant attention, foods calling for a dry look or crisp surface after reheating should not be reheated using this feature. It is best to use Micro Cook.

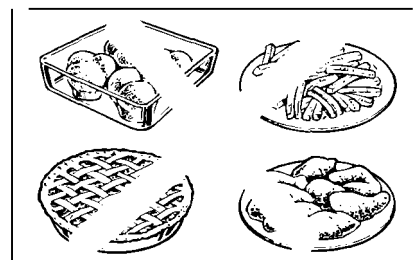

Easy to Use

m
REHEAT

Place covered food in the oven. Touch the REHEAT pad. No need to touch START. The oven will start immediately.

“RHEAT” and “FOOD” are displayed.



A beep sounds when steam is sensed and “RHEAT” is replaced by **time counting down**.

Rotate or stir food if necessary. Close the door and touch START to finish heating. When done, the oven displays “End” and beeps every minute until the door is opened or CLEAR/OFF is touched.

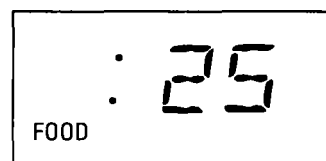

Do not open the oven door while the word “RHEAT” is displayed—steam escaping from the oven can affect reheating performance. If the door is opened, close the door and touch START immediately.

Questions & Answers

Q. If my food is not completely reheated after using Reheat, what should I do?

A. Use Micro Cook to reheat for additional time until desired temperature is reached.

Q. What if I don't fully cover the dish in Reheat?

A. Oven senses steam too quickly, which shortens the reheating time and leaves food too cool. Cover tightly and reset Reheat.



SENSOR COOKING

Canned Vegetables, Frozen Vegetables, Fresh Vegetables, Potatoes, Fish, Chicken Pieces, Meat

The Sensor Cooking pads make cooking many of your favorite foods easy. By actually sensing the steam that escapes as food cooks, this feature automatically adjusts the oven's cooking time to various types and amounts of food.

NOTE: Do not use the metal shelf with Sensor Cooking.

Easy to Use

The Sensor Cooking pads are designed to give you easy, automatic results with many popular foods. (See the Sensor Cooking Control Guide section for specific instructions.)

Simply touch desired food pad. No need to touch START. The oven will start immediately. The name of the selected food pad appears on the display, and the sensor is activated to sense steam from the food.

Keep the Door Closed!

Do not open the oven door until time is counting down on the display. Steam escaping from the oven can affect cooking performance. If the door is opened, close the door and touch START immediately.

Example:

Place covered food in the oven. Touch CHICKEN PIECES pad. The oven will start immediately.

The word "ChiKn" shows on display. The steam sensor is now activated. DO NOT OPEN THE DOOR. OPENING THE DOOR MAY AFFECT COOKING PERFORMANCE.

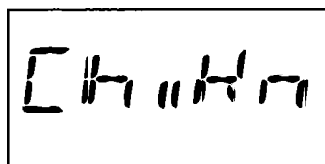

A beep sounds when steam is sensed and "ChiKn" is replaced by the cook time remaining. Rotate the food if necessary. When done, the oven beeps every minute until the door is opened or CLEAR/OFF is touched.

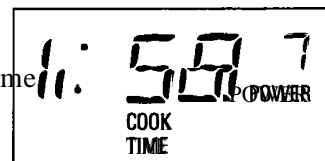

PREFERENCE CONTROL

How to Change the Automatic Settings

You can change the cooking times for some sensor pads (REHEAT, POTATOES, FRESH VEG, MEAT, FISH FILLETS and CHICKEN PIECES) to suit your personal taste. CANNED VEG and FROZEN VEG cannot be changed.

By touching 1 after touching any of these sensor pads, you can set the oven to cook for 10% less time than that sensor feature would regularly provide.

For example, if your plate of food is reheated more than you like it, touch the sensor REHEAT pad and 1 to get a 10% shorter cooking time the next time you cook.

By touching 9 after touching any of these sensor pads, you can set the oven to cook for a 10% longer time than that sensor feature would regularly provide.

REHEAT AND SENSOR COOKING CONTAINERS AND COVERS



Containers and Covers

Appropriate containers and coverings help assure good cooking results.

- **Always use microwave-safe containers and cover them with lids or vented plastic wrap.** Wonder if it's microwave-safe? Put it to the test described in the Microwaving Tips section.
- Never use tight-sealing plastic covers—they can prevent steam from escaping and cause food to overcook.

- **Match the amount of food to the size of the container.** Fill containers at least half full for best results.
- **Be sure the outside of the cooking container and the inside of the microwave oven are dry** before placing food in the oven. Beads of moisture turning into steam can mislead the sensor.
- **Stir or rotate some foods after a beeping signal, if required.** See the Sensor Cooking Control Guide section.

SENSOR COOKING CONTROL GUIDE

- Do not open oven door during cycle. When oven signals and countdown time is displayed, door may be opened for stirring, turning or rotating food. To resume cooking, close door and touch START.
- Match the amount of food to the size of container. Fill containers at least 1/2 full.
- Be sure outside of container and inside of oven are dry.
- After completion of Sensor Cooking cycle, if food needs additional cooking, return food to oven and use Micro Cook to finish cooking.

Features/Pad	Servings	Serving Size	Comments
Canned Vegetables	1 to 4	4 oz.	Use microwave-safe casserole or bowl. Cover with lid or plastic wrap.
Frozen Vegetables	1 to 4	4 oz.	Use microwave-safe casserole or bowl. Follow package instructions for adding water. Cover with lid or plastic wrap.
Fresh Vegetables	1 to 4	4 oz.	Use microwave-safe casserole or bowl. Add 2 tablespoons water for each serving. Cover with lid or plastic wrap.
Potatoes	1 to 4	8 oz.	Pierce skin with fork. Cluster potatoes in center of oven floor.
Fish Fillets	1 to 4	4 oz.	Use oblong, square or round dish. Cover with plastic wrap.
Chicken Pieces	1 to 4	1 to 2 pieces	Use oblong, square or round dish. Cover with wax paper.
Meats (Ground Meats, Beef, Pork, Turkey)	—	1/2 to 3 lbs.	Use round casserole dish. Crumble meat into dish. Cover with wax paper or plastic wrap.



GLOSSARY OF MICROWAVE TERMS

When adapting recipes for the microwave, it is best to start with a familiar recipe. Knowing how the food should look and taste will help when adapting recipes for microwaving. Foods that require browning or crisp, dry surfaces will cook better in regular ovens.

- Moist foods, such as vegetables, fruits, poultry and seafood, microwave well.
- Rich foods, such as bar cookies, moist cakes and candies, are suitable for microwaving because of their high fat and sugar content.
- Reduce regular oven cooking times by 1/2 to 1/3. Check food after minimum time to avoid overcooking.
- Small amounts of butter or oil can be used for flavoring, but are not needed to prevent sticking.
- Seasonings may need to be reduced. Salt meats and vegetables after cooking.

Covering. In both regular baking and microwave cooking, covers hold in moisture, allow for more even heating and reduce cooking time. In regular ovens, partial covering allows excess steam to escape. Venting plastic wrap or covering with wax paper serves the same purpose when microwaving.

Venting. After covering a dish with plastic wrap, you vent the plastic wrap by turning back 1 corner so excess steam can escape.

Arranging Food in Oven. When baking in regular ovens, you position foods, such as cake layers or potatoes, so hot air can flow around them. When microwaving, you arrange foods in a ring, so that all sides are exposed to microwave energy.

Stirring. In range-top cooking, you stir foods up from the bottom to heat them evenly. When microwaving, you stir cooked portions from the outside to the center. Foods that require constant stirring will need only occasional stirring when microwaving.

Turning Over. In range-top cooking, you turn over foods, such as hamburgers, so both sides can directly contact the hot pan. When microwaving, turning is often needed during defrosting or when cooking certain foods, such as frozen hamburgers.

Standing Time. When you cook with regular ovens, foods such as roasts or cakes are allowed to stand to finish cooking or to set. Standing time is especially important in microwave cooking. Note that a microwaved cake is not placed on a cooling rack.

Shielding. In a regular oven, you shield chicken breasts or baked foods to prevent over-browning. When microwaving, you use small strips of foil to shield thin parts, such as the tips of wings and legs on poultry, which would cook before larger parts.

Arcing. Sparks caused by too much metal in the microwave oven or metal touching the side of the oven or foil that is not molded to food.

Prick Foods to Release Pressure. Steam builds up pressure in foods that are tightly covered by a skin or membrane. Prick foods, such as potatoes (as you do before regular oven cooking), egg yolks and chicken livers, to prevent bursting.

Rotating. Occasionally, repositioning a dish in the oven helps food cook more evenly. To rotate 1/2 turn, turn the dish until the side that was to the back of the oven is to the front. To rotate 1/4 turn, turn the dish until the side that was to the back of the oven is to the side.

Basic Microwave Guidelines

Density of Food. In both regular baking and microwave cooking, dense foods, such as potatoes, take longer to cook than light, porous foods, such as rolls, bread or pieces of cake.

Round Shapes. Since microwaves penetrate foods to about 1 inch from top, bottom and sides, round shapes and rings cook more evenly. Corners receive more energy and may overcook. This may also happen when cooking in a regular oven.

Delicacy. Foods with a delicate texture, such as custards, are best cooked at lower power settings to avoid toughening.

Natural Moisture of food affects how it cooks. Very moist foods cook evenly because microwave energy is attracted to water molecules. Food that is uneven in moisture should be covered or allowed to stand so it heats evenly.

Piece Size. Small pieces cook faster than large ones. Pieces that are similar in size and shape cook more evenly. With large pieces of food, reduce the power setting for even cooking.

Shape of Food. In both types of cooking, thin areas cook faster than thick areas. This can be controlled in microwaving by placing thick pieces near the outside edge and thin pieces in the center.

Starting Temperature. Foods taken from the freezer or refrigerator take longer to cook than foods at room temperature. Timings in our recipes are based on the temperatures at which you normally store the foods.

Quantity of Food. In both types of cooking, small amounts usually take less time than large amounts. This is most apparent in microwave cooking, where time is directly related to the number of servings.

Shelf (on models so equipped). Use the shelf to heat more than 1 dish at a time. Take the shelf out when you are not using it.

HEATING OR REHEATING GUIDE

NOTE: Use Power Level High (10) unless otherwise noted.



- Directions below are for heating or reheating already-cooked foods stored in refrigerator or at room temperature. Use microwave-safe cookware.
- Cover most foods for fastest heating. Exceptions are some sandwiches, griddle foods and baked items.
- Bubbling around edges of dish is normal, since the center is the last to heat. Foods heated to 160°F. to 165°F. will provide safe,

palatable results. Adjust temperatures to suit your personal taste. Let foods stand a few minutes before serving.

- Be sure foods are heated throughout before serving. Steaming or bubbling around edges of dish does not necessarily mean food is heated throughout.

If you use a meat thermometer while cooking, make sure it is safe for use in microwave ovens.

Item	Amount	Power Level	Time
Bakery Foods			
Cake, coffee cake, doughnuts, sweet rolls, nut or fruit bread	1 piece 9 inch cake or 12 rolls or doughnuts	Low (3) Low (3)	1/4 to 1/2 min. 2 to 4 min.
Dinner rolls, muffins	1 6 to 8	Medium (5) Medium (5)	1/4 to 1/2 min. 1 to 2 min.
Pie: fruit, nut or custard; 1 slice= 1/8 of 9 inch pie (use minimum time for custard)	1 slice 9 inch pie	Meal-High (7)	1/2 to 1 min. 3 to 5 min.
Beverages			
Cocoa, other milk based drinks (6 oz. per cup)	1 to 2 cups	Meal-High (7)	2 to 4 min.
Coffee, other water-based drinks (6 oz. per cup)	1 to 2 cups		2 to 3 min.
Meats and Main Dishes			
Chicken pieces	to 2 pieces		1 to 2 min.
Hamburgers or meatloaf (4 oz. per serving)	to 2 servings		1 to 2 min.
Hot dogs and sausages	to 2		1 to 1½ min.
Rice and pasta (2/3-3/4 cup per serving)	to 2 servings		1 to 2 min.
Saucy, main dishes: chop suey, spaghetti, creamed chicken, chili, stew, macaroni and cheese, etc. (3/4-1 cup per serving)	to 2 servings		2 to 4 min.
Steaks, chops, ribs, meat pieces	1 to 2 servings	Meal-High (7)	1 ½ to 2½ min.
Thinly-sliced meat (3 to 4 oz. per serving)	1 to 2 servings	Meal-High (7)	1 to 2 min.
Topped or mixed with sauce (2/3-3/4 cup per serving)	1 to 2 servings		2 to 4 min.
Tip: Cover saucy main dishes with plastic wrap. Cover other main dishes and meats with wax paper. When heating or reheating 3 to 4 servings of meat slices or pieces, rotate dish 1/2 turn after half of cooking time.			
Plate of Leftovers			
Meat plus 2 vegetables	1 plate		3 to 4 min.
Tip: Cover plate of food with wax paper or plastic wrap.			
Sandwiches			
Meat-cheese filling: with 2 slices of bread	1 to 2 servings	Meal-High (7)	1 to 2 min.
Moist filling: Sloppy Joes, barbecue, ham salad, etc. in bun (1/3 cup per serving)	1 to 2 servings	Meal-High (7)	1 to 2 min.
Tip: Use paper towel or napkin to cover sandwiches.			
soups			
Milk-based (6 oz. per serving)	1 to 2 servings	Meal-High (7)	1 ½ to 4 min.
Water-based (6 oz. per serving)	1 to 2 servings		1½ to 3 min.
Tip: Cover soups with wax paper or plastic wrap.			
Vegetables			
Large pieces or whole: asparagus spears, corn on the cob, etc.	1 to 2 servings		1 to 3 min.
Mashed (1/2 cup per serving)	1 to 2 servings		2 to 4 min.
Small pieces: peas, beans, corn, etc. (1/2 cup per serving)	1 to 2 servings		1½ to 3 min.
Tip: Cover vegetables for most even heating.			



DEFROSTING GUIDE

1. Food packaged in paper or plastic may be defrosted without unwrapping. If food is foil wrapped, remove foil and place food in cooking dish for defrosting. Most food defrosts well using Defrost (3). For more even defrosting of larger foods, such as beef, lamb and veal roasts, use Warm (1).
2. After first half of defrosting time, unwrap package and check food. Turn food over, if necessary; break apart or separate food if possible. Shield any warm areas with small pieces of foil.
3. Be sure large meats are completely defrosted before cooking.
4. When defrosted, food should be cool but softened in all areas. If still slightly icy, return to microwave oven very briefly, or let stand a few minutes.

Food	Time	Comments
Breads, Cakes [Power Level: Defrost (3)]		
Bread, buns or rolls (1 piece)	1 min.	
Sweet rolls (approx. 12 oz.)	3 to 5 min.	Rearrange after half of time
Fish and Seafood [Power Level: Defrost (3)]		
Fillet s, frozen (1 lb.)	7 to 9 min.	
Shellfish , small pieces (1 lb.)	5 to 7 min.	Place block in casserole. Turn over and breakup after first half of time.
Fruit [Power Level: Defrost (3)]		
Plastic pouch —1 to 2 (10-oz. package)	3 to 6 min.	
Meat [Power Level: Defrost (3)]		
Bacon (1 lb.)	3 to 5 min. per lb.	Place unopened package in oven. Let stand 5 minutes after defrosting.
Franks (1 lb.)	3 to 5 min.	Place unopened package in oven. Microwave just until franks can be separated. Let stand 5 minutes, if necessary, to complete defrosting.
Ground meat (1 lb.)	5 to 7 min.	Turn meat over after first half of time.
Roast : beef, lamb, veal, pork	12 to 16 min. per lb.	Use Power Level Warm (1).
Steaks , chops and cutlets	6 to 8 min. per lb.	Place unwrapped meat in cooking dish. Turn over after first half of time and shield warm areas with foil. After second half of time, separate pieces with table knife. Let stand to complete defrosting.
Poultry [Power Level: Defrost (3)]		
Chicken , broiler-fryer, cut up (2% to 3 lbs.)	16 to 20 min.	Place wrapped chicken in dish. Unwrap and turn over after first half of time. After second half of time, separate pieces and place in cooking dish. Microwave 2 to 4 minutes more, if necessary. Let stand a few minutes to finish defrosting.
Chicken, whole (2% to 3 lbs.)	18 to 22 min.	Place wrapped chicken in dish. After first half of time, unwrap and turn chicken over. Shield warm areas with foil. To complete defrosting, run cool water in cavity until giblets can be removed.
Cornish hen	8 to 14 min. per lb.	Place unwrapped hen in oven breast-side-up. Turn over after first half of time. Run cool water in cavity until giblets can be removed.
Turkey breast (4 to 6 lbs.)	6 to 10 min. per lb.	Place unwrapped breast in microwave-safe dish breast-side-down. After first half of time, turn breast-side-up and shield warm areas with foil. Defrost for second half of time. Let stand 1 to 2 hours in refrigerator to complete defrosting.

COOKING GUIDE

NOTE: Use Power Level High (10) unless otherwise noted.



Vegetables

Vegetable	Amount	Time	Comments
Asparagus (frozen spears)	1 lb.	7 to 9 min., Med-High (7)	In 1 1/2-qt. oblong glass baking dish, place 1/4 cup water. Rotate dish after half of time.
(frozen spears)	10-oz. package	5 to 7 min.	In 1-qt. casserole.
Beans (fresh green)	1 lb. cut in half	10 to 12 min.	In 1 1/2-qt. casserole, place 1/2 cup water.
(frozen green)	10-oz. package	6 to 8 min.	In 1-qt. casserole, place 2 tablespoons water.
(frozen lima)	10-oz. package	6 to 8 min.	In 1-qt. casserole, place 1/4 cup water.
Beets (fresh, whole)	1 bunch	18 to 22 min.	In 2-qt. casserole, place 1/2 cup water.
Broccoli (fresh cut)	1 bunch (1 1/4 to 1 1/2 lbs.)	8 to 10 min.	In 2-qt. casserole, place 1/2 cup water.
(fresh spears)	1 bunch (1 1/4 to 1 1/2 lbs.)	10 to 13 min.	In 2-qt. oblong glass baking dish, place 1/4 cup water. Rotate dish after half of time.
(frozen, chopped)	10-oz. package	5 to 7 min.	In 1-qt. casserole.
(frozen spears)	10-oz. package	5 to 7 min.	In 1-qt. casserole, place 3 tablespoons water.
Cabbage (fresh)	1 medium head (about 2 lbs.)	9 to 11 min.	In 1- or 2-qt. casserole, place 1/4 cup water.
(wedged)		8 to 10 min.	In 2- or 3-qt. casserole, place 1/4 cup water.
Carrots (fresh, sliced)	1 lb.	7 to 9 min.	In 1 1/2-qt. casserole, place 1/4 cup water.
(frozen)	10-oz. package	5 to 7 min.	In 1-qt. casserole, place 2 tablespoons water.
Cauliflower (flowerets)	1 medium head	10 to 14 min.	In 2-qt. casserole, place 1/2 cup water.
(fresh, whole)	1 medium head	10 to 17 min.	In 2-qt. casserole, place 1/2 cup water.
(frozen)	10-oz. package	5 to 7 min.	In 1-qt. casserole, place 2 tablespoons water.
Corn (frozen kernel)	10-oz. package	5 to 7 min.	In 1-qt. casserole, place 2 tablespoons water.
Corn on the cob (fresh)	1 to 5 ears	3 to 4 min. per ear	In 2-qt. oblong glass baking dish, place corn. If corn is in husk, use no water; if corn has been husked, add 1/4 cup water. Rearrange after half of time.
(frozen)	1 ear	5 to 6 min.	Place in 2-qt. oblong glass baking dish.
	2 to 6 ears	3 to 4 min. per ear	Cover with vented plastic wrap. Rearrange after half of time.
Mixed, vegetables (frozen)	10-oz. package	5 to 7 min.	In 1-qt. casserole, place 3 tablespoons water.
Peas (fresh, shelled)	2 lbs. unshelled	10 to 12 min.	In 1-qt. casserole, place 1/4 cup water.
(frozen)	10-oz. package	5 to 7 min.	In 1-qt. casserole, place 2 tablespoons water.
Potatoes (fresh, cubed, white)	4 potatoes (6 to 8 oz. each)	10 to 12 min.	Peel and cut into 1 inch cubes. Place in 2-qt. casserole with 1/2 cup water. Stir after half of time.
(fresh, whole, sweet or white)	1 (6 to 8 oz. each)	3 to 4 min.	Pierce with cooking fork. Place in the oven, 1 inch apart, in circular arrangement. Let stand 5 minutes.
Spinach (fresh)	10 to 16 oz.	5 to 7 min.	In 2-qt. casserole, place washed spinach.
(frozen, chopped and leaf)	10-oz. package	5 to 7 min.	In 1-qt. casserole, place 3 tablespoons water.
Squash (fresh, summer and yellow)	1 lb. diced	5 to 7 min.	In 1 1/2-qt. casserole, place 1/4 cup water.
(winter, acorn or butternut)	1 to 2 squash (about 1 lb. each)	8 to 11 min.	Cut in half and remove fibrous membranes. In 2-qt. oblong glass baking dish, place squash cut-side-down. Turn cut-side-up after 4 minutes.



GUIDE TO USE OF THE OVEN SHELF

- Use the shelf only when cooking food on 2 levels. Food microwaves best when placed directly on the oven floor.
- Do not store or cook with metal shelf on floor of oven. Product damage may result.
- Use pot holders when handling metal shelf and cookware. They may be hot.
- Do not store microwave browning dish on metal shelf.
- Use of shelf with the Sensor Cooking or Reheat program is not recommended.
- Do NOT use the metal shelf with the Popcorn program.

The wire shelf is specifically designed for added capacity heating and reheating in your microwave oven. Now more than one food may be heated or reheated and ready to serve at the same time.

Batters and dough foods and also uncooked foods which need to be prepared from scratch should be cooked without the oven shelf.

Positioning the Shelf

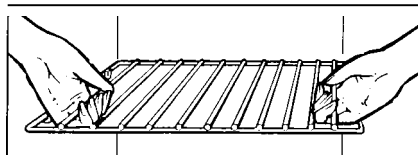

To position the shelf, tip the back slightly and fit the shelf support guides **onto** the support guides located at each side of the oven in the rear.

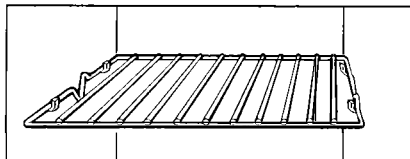

Next, lower the front until the shelf support guides fit **onto** the support guides located at each side of the oven in the front.

When properly positioned, the shelf should fit snugly in place, be level and not touch the back or side wall of the oven.

If arcing occurs when using the shelf to cook more than one food at the same time, turn the oven off. Make sure the shelf is not touching oven walls. To prevent arcing, remove the shelf when you are not using it.

How to Reheat Several Different Types of Foods Together

When heating several different types of food together, foods which should be served hot must be placed on the oven floor, while foods which need only to be warmed should be placed on the shelf. This is because microwave energy enters the oven from the bottom only. Also, it is important to remember that foods absorb microwave energy at different rates. Rates can be affected by the size of the food, and its starting temperature.

Because of the varying rates, you may need to start reheating a large or dense food a few minutes ahead of time, then add other smaller or less dense foods. Alternately, if one of the foods you are heating seems undercooked but the others are heated satisfactorily, let the underheated food continue cooking.

Heat or reheat different types of food at High (10). To determine heating times, add times for all foods together. After half of time, stir or rearrange foods (do not reverse positions). Check foods (especially those on the oven floor) after 3/4 of total time and remove any which are done. Continue cooking others.

Place on the floor larger or more dense foods, which need the most heating, such as leftover fried chicken, casseroles of

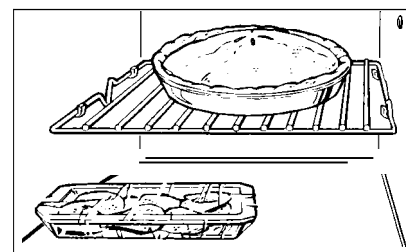

canned or leftover vegetables, rice or pasta. Place on the oven shelf those foods which need only be warmed, such as bakery pies, rolls, muffins or breads.

Pop popcorn on the microwave oven floor only. Use prepackaged popcorn labeled for use in microwave ovens.

CARE AND CLEANING

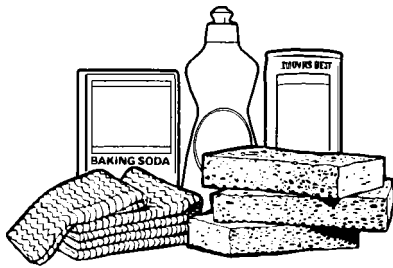
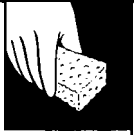

Keep your oven clean and sweet-smelling. Opening the oven door a few minutes after cooking helps air out the inside. An occasional thorough wiping with a solution of baking soda and water keeps the inside fresh.

Don't use sharp-edged utensils on your oven. The inside and outside oven walls can be scratched. The control panel can be damaged.

BE CERTAIN POWER IS OFF BEFORE CLEANING ANY PART OF THIS OVEN.

How to Clean the Inside

Walls and floor. Some spatters can be removed with a paper towel, others may require a damp cloth. Remove greasy spatters with a sudsy cloth, then rinse with a damp cloth. Do not use abrasive cleaners on oven walls. **NEVER USE A COMMERCIAL OVEN CLEANER ON ANY PART OF YOUR MICROWAVE OVEN.**

Door (inside). Window: Wipe up spatters daily and wash when soiled with a damp cloth. Rinse thoroughly and dry.

Metal and plastic parts on door: Wipe frequently with a damp cloth to remove all soil. **DO NOT USE ABRASIVES, SUCH AS CLEANING POWDERS OR STEEL AND PLASTIC PADS. THEY WILL DAMAGE THE SURFACE.**

Special note when using Brown 'N Sear Dish: If grease is present, high heat generated on bottom of a Brown 'N Sear dish may cause the grease to burn onto the oven tray. This may be removed with a cleanser such as Bon Ami® brand cleanser.

After using Bon Ami® brand cleanser, rinse and dry thoroughly, following instructions on can. Do not use Bon Ami® brand cleanser on the painted surfaces such as the walls. It may scratch the paint.

Automatic Temperature Probe. Probe is sturdy, but care should be taken in handling. Do not twist or bend; avoid dropping temperature probe.

Clean as soon after using as possible. To clean, wipe with sudsy cloth, then rub lightly with plastic scouring ball if necessary. Rinse and dry or wash in dishwasher.

Shelf. Your shelf accessory is designed for use in a microwave oven only; do not use in a regular oven. Do not use a browning dish with the shelf. Arcing could occur.

Clean shelf with mild soap and water or in the dishwasher. **Do not clean in a self-cleaning oven.**

How to Clean the Outside

Case. Clean the outside of your oven with soap and damp cloth, rinse with a damp cloth and then dry. Wipe the window clean with a damp cloth. Chrome trim is best wiped with a damp cloth and then with a dry towel.

Control Panel. Wipe with a damp cloth. Dry thoroughly. Do not use cleaning sprays, large amounts of soap and water, abrasives or sharp objects on the panel—they can damage it.

Door Surface. When cleaning surfaces of door and oven that come together on closing the door, use only mild, non-abrasive soaps or detergents applied with a sponge or soft cloth.

Power Cord. If the cord becomes soiled, unplug and wash with a damp cloth. For stubborn spots, sudsy water may be used, but be certain to rinse with a damp cloth and dry thoroughly before plugging cord into outlet.

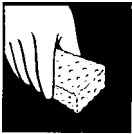

LIGHT BULB REPLACEMENT

Cooktop Light./Night Light

To replace combination cooktop/night light, first disconnect power at main fuse or circuit breaker panel or pull plug.

Remove screw on right side of light compartment cover and lower cover until it stops.

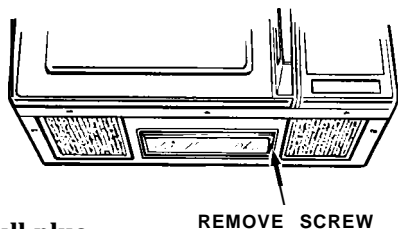

Be sure bulbs to be replaced are cool before removing. Break the adhesive seal by gently unscrewing the bulbs. Replace with 40-watt

incandescent bulbs (WB02X4253) available from your GE supplier. High intensity 40-watt bulbs (40S 1 IN/1), which are available in supermarkets and hardware stores, may also be used for replacements. Raise light compartment cover and replace screw. Connect electrical power to microwave oven.

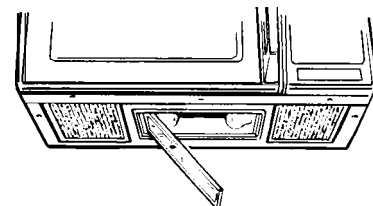

Oven Light

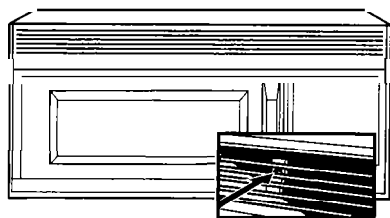

To replace your oven light, first disconnect power at main fuse or circuit breaker panel or pull plug. Remove the top grill by taking out the 2 screws that hold it in place.

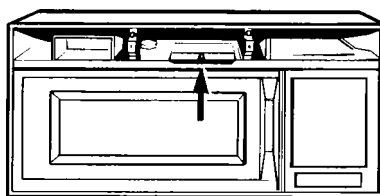

Next, remove the single screw located above door near center of oven that secures light housing. Replace burned-out bulb with a 30-watt incandescent bulb (WB02X4235), available from your GE supplier.

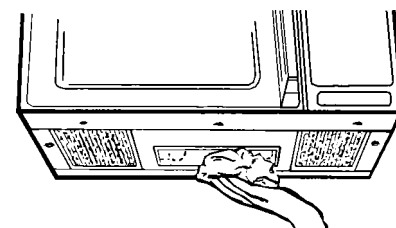

Clean off the grease and dust on hood surfaces often. Use a solution of warm water and detergent. About 1 tablespoon of ammonia may be added to the water. Take care not to touch the filters and enamel surfaces with this solution; ammonia will darken metal.

GROUNDING INSTRUCTIONS

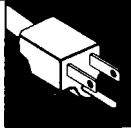

This appliance must be grounded. In the event of an electrical short circuit, grounding reduces the risk of electric shock by providing an escape wire for the electric current. This appliance is equipped with a power cord having a grounding wire with a grounding plug. The plug must be plugged into an outlet that is properly installed and grounded. (Fig. 1)

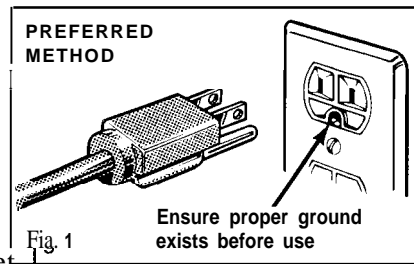

Consult a qualified electrician or service technician if the grounding instructions are not completely understood, or if doubt exists as to whether the appliance is properly grounded.

Where a standard 2-prong wall receptacle is encountered, it is your personal responsibility and obligation to have it replaced with a properly grounded 3-prong wall receptacle.

Do not under any circumstance cut or remove the third (ground) prong from the power cord.

Do not use an adapter plug with this appliance.

Do not use an extension cord with this appliance.

WARNING—Improper use of the grounding plug can result in a risk of electric shock.

THE EXHAUST FEATURE

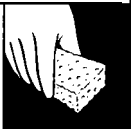

The exhaust hood feature on your microwave oven is equipped with two metal filters which collect grease. When the fan is operated, air is drawn up through the filters and is then discharged through the provided venting to the outside.

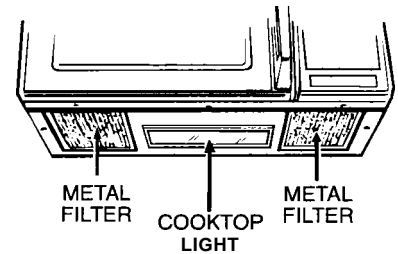

Reusable Grease Filters

The grease filters should be cleaned at least once a month. Never operate the microwave without the filters in place. In situations where flaming might occur on surfaces below hood, filters will stop the entry of flames into the unit.

To Remove Grease Filter

To remove grease filter, grasp the “finger hold” on the filter and slide to the rear. Then pull filter downward and to the front. The filter will drop out.

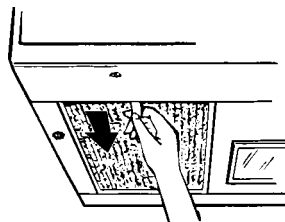

To Clean and Replace Grease Filter

To clean grease filter, soak it and then agitate filter in solution of hot water and detergent. Don't use ammonia or ammonia products because they will darken the metal. Light brushing can be used to remove embedded dirt.

Rinse, shake and remove moisture before replacing.

To replace grease filter, slide the filter in the frame slot on the back of the opening.

Pull filter upward and to the front to lock into place.

(continued next page)

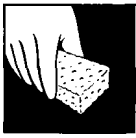

THE EXHAUST FEATURE

(continued)

Charcoal Filter Kit (for some models)

There is a Recirculating Charcoal Filter Kit available for models that are not vented to the outside. Filter Kit model JX81A can be ordered from your GE supplier. Ask for part WB02X9883.



QUESTIONS? USE THIS PROBLEM SOLVER

PROBLEM	POSSIBLE CAUSE
OVEN WILL NOT COME ON	<ul style="list-style-type: none"> •A fuse in your home may be blown or the circuit breaker tripped. Replace fuse or reset circuit breaker. •Unplug your microwave oven, then plug it back in. •Make sure 3-prong plug on oven is fully inserted into wall receptacle.
CONTROL PANEL LIGHTED, YET OVEN WILL NOT START	<ul style="list-style-type: none"> •Door not securely closed. •START pad must be touched after entering cooking selection. •Another selection entered already in oven and CLEAR/OFF pad not touched to cancel it. •Make sure you have entered cooking time after touching MICRO COOK pad. •CLEAR/OFF pad was touched accidentally. Reset cooking program and touch START pad. •Make sure you have entered a temperature after touching TEMP COOK/HOLD pad. •Make sure you have entered a code number after touching AUTO ROAST or COOK pad.
“PRObE” APPEARS ON DISPLAY	<ul style="list-style-type: none"> •Probe has been forgotten or not seated properly in oven wall when using Temp Cook/Hold or Auto Roast function.
“Error” APPEARS ON DISPLAY	<ul style="list-style-type: none"> • During Sensor Cooking, Reheat or Popcorn program, the door was opened before steam could be detected, or steam was not detected in maximum time.
FLOOR OF THE OVEN IS WARM, EVEN WHEN THE OVEN HAS NOT BEEN USED	<ul style="list-style-type: none"> •The cooktop lamp is located directly below the oven floor. When the lamp is on, the heat it produces makes the oven floor get warm. This is normal.

All these things are normal with your microwave oven:

- Steam or vapor escaping from around the door.
- Light reflection around door or outer case.
- Dimming oven light and change in blower sound may occur while operating at power levels other than high.
- Dull thumping sound while oven is operating.
- Some TV-Radio interference might be noticed while using your microwave oven. It's similar to the interference caused by other small appliances and does not indicate a problem with your oven.

If you need more help... call, toll free: GE Answer Center®/ 800.626.2000/ consumer information service

NOTES

NOTES

We'll Be There

With the purchase of your new GE appliance, receive the assurance that if you ever need information or assistance from GE, we'll be there. All you have to do is call—toll-free!

GE Answer Center® **800.626.2000**

Whatever your question about any GE major appliance, GE Answer Center® information service is available to help. Your call—and your question—will be answered promptly and courteously. And you can call any time. GE Answer Center® service is open 24 hours a day, 7 days a week.

In-Home Repair Service **800-GE-CARES (800-432-2737)**

AGE consumer service professional will provide expert repair service, scheduled at a time that's convenient for you. Many GE Consumer Service company-operated locations offer you service today or tomorrow, or at your convenience (7:00 a.m. to 7:00 p.m. weekdays, 9:00 a.m. to 2:00 p.m. Saturdays). Our factory-trained technicians know your appliance inside and out—so most repairs can be handled in just one visit.

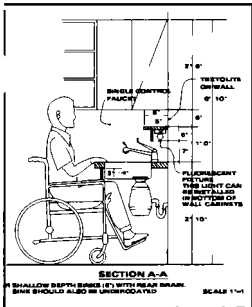

For Customers With Special Needs... **800.626.2000**

Upon request, GE will provide Braille controls for a variety of GE appliances, and a brochure to assist in planning a barrier-free kitchen for persons with limited mobility. To obtain these items, free of charge, call 800.626.2000.

Consumers with impaired hearing or speech who have access to a TDD or a conventional teletypewriter may call 800-TDD-GEAC (800-833-4322) to request information or service.

Service Contracts **800.626.2224**

You can have the secure feeling that GE Consumer Service will still be there after your warranty expires. Purchase a GE contract while your warranty is still in effect and you'll receive a substantial discount. With a multiple-year contract, you're assured of future service at today's prices.

Parts and Accessories **800.626.2002**

Individuals qualified to service their own appliances can have needed parts or accessories sent directly to their home. The GE parts system provides access to over 47,000 parts... and all GE Genuine Renewal Parts are fully warranted. VISA, MasterCard and Discover cards are accepted.

User maintenance instructions contained in this booklet cover procedures intended to be performed by any user. Other servicing generally should be referred to qualified service personnel. Caution must be exercised, since improper servicing may cause unsafe operation.

YOUR GE MICROWAVE OVEN WARRANTY

Staple sales slip or cancelled check here. Proof of original purchase date is needed to obtain service under warranty.

WHAT IS COVERED

FULL ONE-YEAR WARRANTY

For one year from date of original purchase, we will provide, free of charge, parts and service labor in your home to repair or replace **any part of the microwave oven** that fails because of a manufacturing defect.

LIMITED ADDITIONAL NINE-YEAR WARRANTY

For the second through tenth year from date of original purchase, we will provide, free of charge, a replacement **magnetron tube** if the magnetron tube fails because of a manufacturing defect. You pay for the service trip to your home and service labor charges.

***** **

This warranty is extended to the original purchaser and any succeeding owner for products purchased for ordinary home use in the 48 mainland states, Hawaii and Washington, D.C. In Alaska the warranty is the same except that it is LIMITED because you must pay to ship the product to the service shop or for the service technician's travel costs to your home.

All warranty service will be provided by our Factory Service Centers or by our authorized Customer Care® servicers during normal working hours.

Should your appliance need service, during warranty period or beyond, call 800-GE-CARES (800-432-2737).

WHAT IS NOT COVERED

- Service trips to your home to teach you how to use the product.

Read your Use and Care material.

If you then have any questions about operating the product, please contact your dealer or our Consumer Affairs office at the address below, or call, toll free:

GE Answer Center™
800.626.2000
consumer information service

- Improper installation.

If you have an installation problem contact your dealer or installer. You are responsible for providing adequate electrical, gas, exhausting and other connecting facilities.

- Replacement of house fuses or resetting of circuit breakers.
- Failure of the product if it is used for other than its intended purpose or used commercially.
- Damage to product caused by accident, fire, floods or acts of God.

WARRANTOR IS **NOT** RESPONSIBLE FOR CONSEQUENTIAL DAMAGES.

Some states do not allow the exclusion or limitation of incidental or consequential damages, so the above limitation or exclusion may not apply to you. This warranty gives you specific legal rights, and you may also have other rights which vary from state to state. To know what your legal rights are in your state, consult your local or state consumer affairs office or your state's Attorney General.

Warrantor: General Electric Company

If further help is needed concerning this warranty, write:
Manager—Consumer Affairs, GE Appliances, Louisville, KY 40225

Part No. 164D2966P143

Pub. No. 49-8623

JVIV..

Printed in the United States