



# Use and Care & Cooking Guide

## Spacemaker® Microwave Oven



<b>Safety</b> instructions .....	2-5
Precautions .....	2- 5



<b>Operating Instructions, Tips</b>	
Aluminum Foil .....	4, 17
Auto Defrost .....	14, 15
Automatic Fan Feature.....	6
Auto Start/Reminder .....	12
Clock .....	8
Control Panel .....	8
Cooking Complete Reminder .....	7
Cooking Guide .....	22-28
Defrosting by Time .....	13
Defrosting Guide .....	20, 21
Delayed Cooking .....	9
Exhaust Fan.....	6
Express Cook Feature .....	11
Features .....	7
Glossary of Microwave Terms .....	16
Heating or Reheating Guide.....	18, 19
Hold Time .....	9
Microwave Cookware Guide .....	1 7
Microwaving Tips .....	6
Minute/Second Timer .....	9, 10
Popcorn .....	12
Power Levels .....	10, 11, 13
Time Cook .....	10-12



Care and Cleaning .....	29-31
Exhaust Fan .....	30
Grease Filter .....	30
Light Bulb Replacement .....	3 1



Problem <b>Solver</b> .....	32
More questions ?...call	
<b>GE Answer Center® 800.626.2000</b>	



Installation .....	31
Adapter Plugs .....	31
Extension Cords .....	3 1
Grounding instructions .....	3 1



Consumer Services .....	35
Appliance Registration .....	2
Model and Serial Numbers .....	2
Warranty .....	Back Cover

*Models JVM132K  
JVM133K*

*Microwave power output  
of this oven is 750 watts.  
(IEC-705 Test Procedure)*



## HELP US HELP YOU...

### **Before using your oven, read this book carefully.**

It is **intended** to help you operate and maintain your new microwave oven properly.

Keep it handy for answers to your questions.

If you don't understand something or need more help, write (include your phone number):

Consumer Affairs  
GE Appliances  
Appliance Park  
Louisville, KY 40225

### **Write down the model and serial numbers.**

You'll find them on a label inside the oven.

These numbers are also on the Consumer Product Ownership Registration Card that came with your microwave oven. Before sending in this card, please write these numbers here:

---

Model Number

---

Serial Number

Use these numbers in any correspondence or service calls concerning your microwave oven.

### **Be sure your microwave oven is registered.**

It is important that we know the location of your microwave oven should a need occur for adjustments.

Your supplier is responsible for registering you as the owner.

Please check with your supplier to be sure he has done so; also send in your Consumer Product Ownership Registration Card. If you move, or if you are not the original purchaser, please write to us, stating model and serial numbers.

### **This appliance must be registered. Please be certain that it is.**

Write to:

GE Appliances  
Range Product Service  
Appliance Park  
Louisville, KY 40225

### **If you received a damaged oven...**

Immediately contact the dealer (or builder) that sold you the oven.

### **Save time and money. Before you request service...**

Check the Problem Solver in the back of this book. It lists causes of minor operating problems that you can correct yourself.

### **All these things are normal with your microwave oven.**

- Steam or vapor escaping from around the door.
- Light reflection around door or outer case.
- Dimming oven light and change in blower sound may occur while operating at power levels other than high.
- Dull thumping sound while oven is operating.
- Some TV-Radio interference might be noticed while using your microwave oven. It's similar to the interference caused by other small appliances and does not indicate a problem with your oven.

## IF YOU NEED SERVICE...

To obtain service, see the Consumer Services page in the back of this book.

We're proud of our service and want you to be pleased. If for some reason you are not happy with the service you receive, here are three steps to follow for further help.

**FIRST**, contact the people who serviced your appliance. Explain why you are not pleased. In most cases, this will solve the problem.

**NEXT**, if you are still not pleased, write all the details—including your phone number—to:

Manager, Consumer Relations  
GE Appliances  
Appliance Park  
Louisville, KY 40225

**FINALLY**, if your problem is still not resolved, write:

Major Appliance Consumer  
Action Panel  
20 North Wacker Drive  
Chicago, IL 60606

# IMPORTANT SAFETY INSTRUCTIONS

Read all instructions before using this appliance.



## Precautions to Avoid Possible Exposure to Excessive Microwave Energy

(a) **Do Not Attempt** to operate this oven with the door open since open-door operation can result in harmful exposure to microwave energy. It is important not to defeat or tamper with the safety interlocks.

(b) **Do Not Place** any object between the oven front face and the door or allow soil or cleaner residue to accumulate on sealing surfaces.

(c) **Do Not Operate** the oven if it is damaged. It is particularly important that the oven door close properly and that there is no damage to the:

- (1) door (bent)
- (2) hinges and latches (broken or loosened)
- (3) door seals and sealing surfaces.

(d) **The Oven Should Not** be adjusted or repaired by anyone except properly qualified service personnel.

When using electrical appliances, basic safety precautions should be followed, including the following:

**▲ WARNING**—To reduce the risk of burns, electric shock, fire, injury to persons or exposure to excessive microwave energy:

• Use this appliance only for its intended use as described in this manual.

• **Read and follow** the specific “Precautions to Avoid Possible Exposure to Excessive Microwave Energy” in this book.

• **This appliance must be grounded.** Connect only to properly grounded outlet. See “GROUNDING INSTRUCTIONS.”

• **Use this appliance only for its intended use as described in this manual.** Do not use corrosive chemicals or vapors in this appliance. This microwave oven is specifically designed to heat or cook food, and is not intended for laboratory or industrial use.

• For best operation, plug this appliance into its own electrical outlet, to prevent flickering of lights, blowing of fuse or tripping of circuit breaker.

• **Do not mount this appliance over a sink. Install or locate this appliance only in accordance with the provided Installation Instructions.**

• **Do not cover or block any openings on the appliance.**

• **Do not store this appliance outdoors.** Do not use this product near water—for example, in a wet basement or near a swimming pool.

• **Do not immerse power cord or plug in water.**

• **Keep power cord away from heated surfaces.**

• **Do not let power cord hang over edge of table or counter.**

• **Do not operate this appliance if it has a damaged power cord or plug, if it is not working properly, or if it has been damaged or dropped.**

• See door surface cleaning instructions in the Care and Cleaning section(s) of your book.

• **This appliance should be serviced only by qualified service personnel.** Contact nearest authorized service facility for examination, repair or adjustment.

• **As with any appliance, close supervision is necessary when used by children.**

• **To reduce the risk of fire in the oven cavity:**

—**Do not overcook food.** Carefully attend appliance if paper, plastic or other combustible materials are placed inside the oven to facilitate cooking.

—**Remove wire twist-ties** from paper or plastic bags before placing bags in oven.

—**Do not use your microwave oven to dry newspapers.**

—**Do not use recycled paper products.** Recycled paper towels, napkins and waxed paper can contain metal flecks which may cause arcing or ignite. Paper products containing nylon or nylon filaments should be avoided, as they may also ignite.

(continued next page)



# IMPORTANT SAFETY INSTRUCTIONS

(continued)

—**Do not pop popcorn** in your microwave oven unless in a special microwave popcorn accessory or unless you use popcorn labeled for use in microwave ovens.

—**Do not overcook potatoes.** They could dehydrate and catch fire, causing damage to your oven.

—**Do not** operate the oven while empty to avoid damage to the oven and the danger of fire. If by accident the oven should run empty a minute or two, no harm is done. However, try to avoid operating the oven empty at all times—it saves energy and prolongs the life of the oven.

---

• **Do not use the oven for storage purposes.** Do not leave paper products, cooking utensils or food in the oven when not in use.

• **If materials inside oven should ignite,** keep oven door closed, turn oven off, and disconnect power cord, or shut off power at the fuse or circuit breaker panel.

• **Some** products such as whole eggs and sealed containers—for example, closed jars—will explode and should not be heated in this microwave oven. Such use of the microwave oven could result in injury.

• **Avoid heating baby food** in glass jars, even without their lids; especially meat and egg mixtures.

• **Don't defrost frozen beverages** in narrow necked bottles (especially carbonated beverages). Even if the container is opened, pressure can build up. This can cause the container to burst, possibly resulting in injury.

• **Use metal only as directed in this book.** TV dinners may be microwaved in foil trays less than 3/4" high; remove top foil cover and return tray to box. When using metal in the microwave oven, **keep metal at least 1 inch away from sides of oven.**



• **Cookware may become hot** because of heat transferred from the heated food. Pot holders may be needed to handle the cookware.

• **Foods cooked in liquids** (such as pasta) may tend to boil over more rapidly than foods containing less moisture. Should this occur, refer to the Care and Cleaning section(s) for instructions on how to clean the inside of the oven.

• **Thermometer**—Do not use a thermometer in food you are microwaving unless the thermometer is designed or recommended for use in the microwave oven.

• **Plastic cookware**—Plastic cookware designed for microwave cooking is very useful, but should be used carefully. Even microwave-safe plastic may not be as tolerant of overcooking conditions as are glass or ceramic materials and may soften or char if subjected to short periods of overcooking. In longer exposures to overcooking, the food and cookware could ignite. For these reasons: 1) Use microwave-safe plastics only and use them in strict compliance with the cookware manufacturer's recommendations. 2) Do not subject empty cookware to microwaving. 3) Do not permit children to use plastic cookware without complete supervision.

---

• **When cooking pork,** follow the directions exactly and always cook the meat to an internal temperature of at least 170°F. This assures that, in the remote possibility that trichina may be present in the meat, it will be killed and meat will be safe to eat.

• **Do not boil eggs in a microwave oven.** Pressure will build up inside egg yolk and will cause it to burst, possibly resulting in injury.



• **Foods with unbroken outer "skin"** such as potatoes, sausages, tomatoes, apples, chicken livers and other giblets, and egg yolks (see previous caution) should be pierced to allow steam to escape during cooking.

---

• **Not** all plastic wrap is suitable for use in microwave ovens. Check the package for proper use.

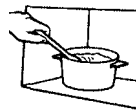

• **Spontaneous boiling**—Under certain special circumstances, liquids may start to boil during or shortly after removal from the microwave oven. To prevent burns from splashing liquid, stir the liquid briefly before removing the container from the microwave oven.



• **“Boilable” cooking pouches and tightly closed plastic bags should be slit, pierced or vented** as directed by package. If they are not, plastic could burst during or immediately after cooking, possibly resulting in injury. Also, plastic storage containers should be at least partially uncovered because they form a tight seal. When cooking with containers tightly covered with plastic wrap, remove covering carefully and direct steam away from hands and face.



• **Hot foods and steam can cause burns. Be careful when opening any containers of hot food, including popcorn bags, cooking pouches and boxes.** To prevent possible injury, direct steam away from hands and face.

## The Exhaust Hood

• **Have it installed and properly grounded by a qualified installer.** See the special installation booklet packed with the microwave oven.

• **The exhaust fan in the oven will operate automatically under certain conditions (see Automatic Fan Feature).** While the fan is operating, caution is required to prevent the starting and spreading of accidental cooking fires while the exhaust fan is in use. For this reason:

—**Never leave surface units unattended at high heat settings.** Boilover causes smoking and greasy spillovers that may ignite and spread if exhaust fan is operating. To minimize automatic fan operation, use adequate sized cookware and use high heat only when necessary.



—**In the event of a grease fire, smother flaming pan on surface unit by covering pan completely with well-fitting lid, cookie sheet or flat tray.**

—**Never flame foods under the oven with the exhaust fan operating because it may spread the flames.**

—**Keep hood and grease filters clean, according to instructions in the Exhaust Feature section, to maintain good venting and avoid grease fires.**

## SAVE THESE INSTRUCTIONS

### Optional Accessories

Available at extra cost from your GE supplier.

**JX40WH Filler Panel Kit.**

**JX81A Charcoal Filter Kit** for non-vented installation.

This microwave oven is UL listed for installation over electric and gas ranges.



## MICROWAVING TIPS

• **Make sure all cookware used in your microwave oven is suitable for microwaving.** Most glass casseroles, cooking dishes, measuring cups, custard cups, pottery or china dinnerware which does not have metallic trim or glaze with a metallic sheen can be used. Some cookware is labeled “suitable for microwaving.”

**If you are not sure if a dish is microwave-safe, use this test:** Place in the oven both the dish you are testing and a glass measuring cup filled with one cup of water—set the measuring cup either in or next to the dish. Microwave 1 minute at high. If the dish heats, it should not be used for microwaving. If the dish remains cool and only the water in the cup heats, then the dish is microwave-safe.

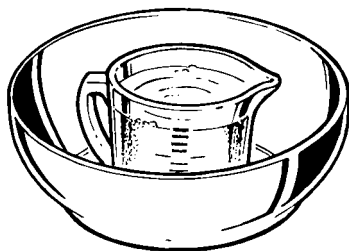

• **Paper towels, waxed paper and plastic wrap** can be used to cover dishes in order to retain moisture and prevent spattering. Be sure to vent plastic wrap so steam can escape.

• **Some microwaved foods require stirring, rotating or rearranging.** Check the Cooking Guide.

• **Steam builds up pressure in foods which are tightly covered by a skin or membrane.** Pierce potatoes, egg yolks and chicken livers to prevent bursting.

If you use a meat thermometer while cooking, make sure it is safe for use in microwave ovens.

## AUTOMATIC FAN FEATURE

Cooking appliances installed under the oven may, under some heavy usage conditions, cause temperatures high enough to overheat some internal parts of the microwave oven.

To prevent overheating from taking place, the exhaust fan is designed to automatically turn on at a low speed if excessive temperatures occur. Should this happen, the fan cannot be manually turned off, but it will automatically turn off when the internal parts have cooled. The fan may stay on up to approximately 30 minutes after the range and microwave oven controls have been turned off.

# FEATURES OF YOUR OVEN

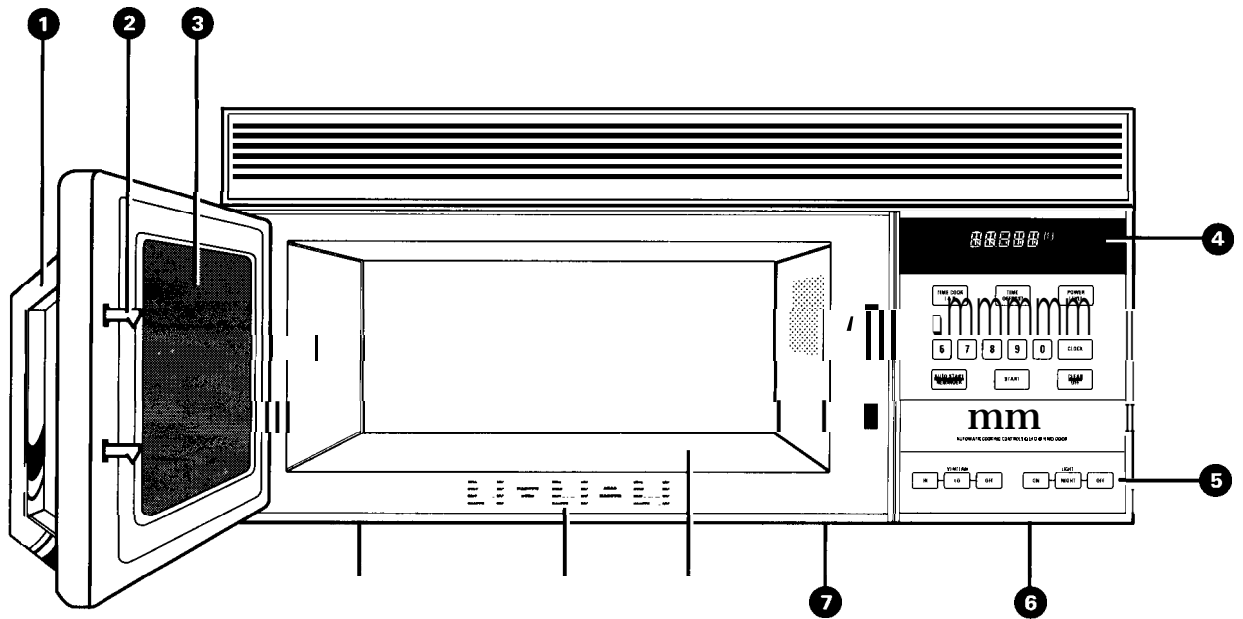

**1.0 Cubic Foot  
Oven Interior**

**1. Door Handle.** Pull to open door. Door must be securely latched for oven to operate.

**2. Door Latches.**

**3. Window with Metal Shield.** Screen allows cooking to be viewed while keeping microwaves confined in oven.

**4. Touch Control Panel and Digital Display.** For detailed information on each feature, see Your Touch Control Panel section.

**5. Hood Controls. Fan.** Press HI, LO or OFF. **Light.** Press ON, NIGHT or OFF.

**6. Grease Filters.**

**7. Cooktop Light.**

**8. Oven Floor.**

**9. Auto Defrost Guide.**

**NOTE:** Rating plate, oven vent(s) and oven light are located on the inside walls of the microwave oven.

## Cooking Complete Reminder

To remind you that you have food in the oven, the oven will display "End" and beep once a minute until you either open the oven door or touch the CLEAR/OFF pad.

This is to certify that this unit has been tested in conformance with AMCA Bulletin No. 210.	C.F.M. at 0.10 WG 215 Vert. 224 Her.	SONES 6.3 Vert. 5.9 Her.
--	---	--------------------------------



# YOUR TOUCH CONTROL PANEL

The Touch Control Panel allows you to set the oven controls with the touch of a finger. It's designed to be easy to use and understand.

## When You Plug in the Oven

The display panel displays five 8's, 18 POWER and all of the oven functions. After 15 seconds, all lights disappear and "RESET" appears in the upper portion. Touch the CLEAR/OFF pad, set the Clock and oven is ready for use.

If power is disrupted at any time, the above sequence recurs, and you must reset Clock after touching the CLEAR/OFF pad.

**1. DISPLAY.** Displays time of day, time or temperature during cooking functions, power level being used, cooking mode and instructions.

**2. TIME DEFROST.** Gentle thawing at automatic power level 3 (Low).

**3. TIME COOK I & II.** Microwave for a selected amount of time using automatic power level 10 (High).

**4. NUMBER PADS.** Touch these pads to enter cooking time, defrosting time, time of day, temperature, power level, or food weights for Auto Defrost.

**5. START.** After all selections are made, touch this pad to start the oven.

**6. AUTO START/REMINDER.** Allows you to program your oven to begin cooking at a preset time of day—up to a 12-hour delay. The Reminder feature can be used like an alarm clock.

**7. POPCORN.** Touch this pad, then START to cook prepackaged microwave popcorn weighing 3.0 to 3.7 ounces.

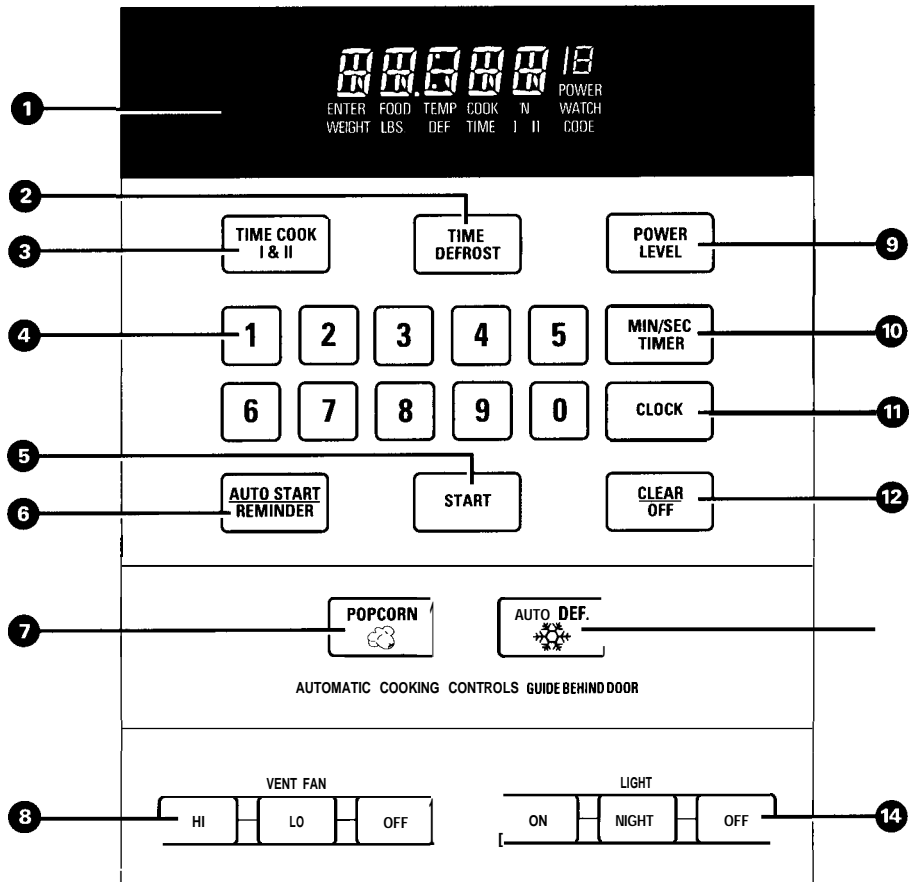

**8. VENT FAN.** Press HI, LO or OFF for the different fan speeds.

**9. POWER LEVEL.** Touch this pad before entering another power level number if you want to change from automatic power level 10 (High) for cooking or power level 3 (Low) for defrosting.

**10. MIN/SEC TIMER.** This feature uses no microwave energy. It functions as either a kitchen timer, as a holding period after defrost or as a delay timer before time or temperature cooking.

**11. CLOCK.** Touch this pad to enter time of day or check time of day while microwaving. To set clock, first touch CLOCK pad

and then enter time of day. For example, if time is 1:30, touch number pads 1, 3 and 0 and "1:30" will appear in display. Then touch START or CLOCK pad. To reset or change time, simply repeat above process.

**12. CLEAR/OFF.** When touched, it shuts off the oven and erases all settings (except time of day).

**13. AUTO DEFROST.** Touch this pad and food weight, then START. The oven automatically sets power levels and defrosting time.

**14. LIGHT.** Touch ON to turn on hood light. Touch NIGHT to turn on night light.



# HOW TO USE THE MINUTE/SECOND TIMER



## The Minute/Second Timer

The Minute/Second Timer has three timing functions:

- It operates as a minute timer.
- It can be set to delay cooking.
- It can be used as a hold setting after defrosting.

The Minute/Second Timer operates without microwave energy.

## Using a Holding Time

The Minute/Second Timer can also be used to program a “holding time” between microwave cooking functions. The time can range from one second to 99 minutes and 99 seconds. A holding or standing time may be found in some of your own recipes or in the Cooking Guide.

## How to Time a 3-Minute Phone Call

1. Touch MIN/SEC TIMER pad.
2. Touch number pads 3,0 and O (for 3 minutes and no seconds).
3. Touch START. Display shows time counting down. The timer signals when time is up.

## Programming Delayed Cooking

To delay cooking up to 99 minutes and 99 seconds, touch TIME COOK and enter cook time. Touch MIN/SEC TIMER and enter number of minutes to delay cooking. Touch START. Timer will count down to zero and cooking will begin.

## How to Defrost, Hold and Time Cook

Let’s say you want to defrost a frozen casserole for 15 minutes, hold for 10 minutes and then Time Cook for 25 minutes. Here’s how to do it:

**Step 1:** Take casserole from freezer and place in oven.



**Step 2:** Touch TIME DEFROST pad.

**Step 3:** Touch pads 1, 5, 0 and O for 15 minutes defrosting time. (Defrosting is automatically set on power level 3 but can be changed by touching the POWER LEVEL pad and the desired power level.)



**Step 4:** Set standing or hold time by touching MIN/SEC TIMER pad.

**Step 5:** Touch 1, 0, 0 and O to hold for ten minutes.



**Step 6:** Touch TIME COOK I & II pad.

**Step 7:** Touch 2, 5, 0 and O for 25 minutes of cooking time.



**Step 8:** Touch START. As each function is automatically performed, oven display shows instructions entered and the function. When time is up, the oven signals and flashes “End.”

*(continued next page)*



# HOW TO USE THE MINUTE/SECOND TIMER

(continued)

## Questions and Answers

**Q. What will happen if I accidentally reverse my defrost, hold and cook instructions?**

**A.** The oven will automatically rearrange your program. Defrosting will always come first, then hold, and then the cooking function.

**Q. Can I defrost and hold only?**

**A. Yes.** Sometimes you may only want to defrost a food, hold it, and cook it later. All you need to do is program in defrost and amount of time. Then program the hold time. Be sure to put the thawed dish in the refrigerator promptly.

**NOTE:** Foods that spoil easily, such as milk, eggs, fish, stuffings, poultry and pork should not be allowed to sit out for more than one hour after defrosting. Room temperature promotes the growth of harmful bacteria.

**Q. I programmed my oven for a specific defrosting time but it defrosted longer than necessary. What happened?**

**A.** When instructions conflict, the oven carries out the last instruction. You may have set the oven to defrost for 4 minutes, hold for 2 minutes, and then defrost for 6 minutes. In this case, the oven would defrost for 6 minutes and hold for 2 minutes.

## COOKING BY TIME

### Time Cook

**Time Cook I & II allows you to microwave for a selected amount of time.**

Power level 10 (High) is recommended for most cooking, but you may change this for more flexibility. See the Cooking Guide.

To become better acquainted with time cooking, make a cup of coffee by following the steps below.

**Step 1:** Fill a cup 2/3 full of water, add 1 teaspoon of instant coffee and stir to dissolve. Use a cup that has no metal decoration and is microwave-safe (refer to Microwaving Tips section). Place cup in oven and close door.

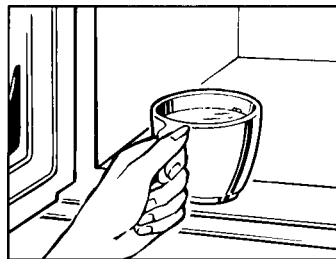

**Step 2:** Touch TIME COOK I & II pad.



**Step 3:** Select your time. Touch pads 1, () and () for one minute.

Because automatic power level 10 is recommended for this cup of coffee, there is no need to change the power level. (If power level 10 is not appropriate, see "How to Change Power Level" on next page.)



**Step 4:** Touch the START pad.

**Step 5:** When time is up, the oven signals and flashes "End." The oven, light and fan shut off.

**Step 6:** Open the door.

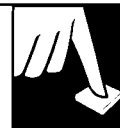

## Using the Time Cook II Feature

The Time Cook II feature lets you set two time cooking functions within one program. This is ideal if you want to change power levels during your cooking operations. Here's how to do it.

**Step 1:** Place food in oven in microwave-safe container and close the door.



**Step 2:** Touch TIME COOK I & II

**Step 3:** Select your first cook time. For example, touch 2, 1 and 5 for two minutes and 15 seconds.

**Step 4:** Touch TIME COOK I & II.

**Step 5:** Set your second cook time.

### How to Change Power Level

After setting cooking time, touch POWER LEVEL pad, then touch desired number for new power level.

**Step 6:** Touch START.

**Step 7:** At the end of "COOK TIME I," the second power level is displayed and "COOK TIME II" is shown counting down.

**Step 8:** When time is up, the oven signals and flashes "End." The oven, light and fan shut off.

**Step 9:** Open the door.

## The Express Cook Feature

The Express Cook feature is a short-cut method to set time for 1-5 minutes.

To Express Cook your food or beverage:

**Step 1:** Touch a number pad (from 1 to 5) that corresponds with the amount of your desired cooking time (in minutes). For example, touch the 2 pad for 2 minutes of cooking time.

**Step 2:** Touch the START pad.

The oven will automatically signal, flash "End" and shut off at the end of the programmed time.

## Questions and Answers

**Q. I set my oven for the time called for in the recipe, but at the end of the time allowed, my food was not done. What happened?**

**A.** Since house power varies due to time or location, many Time Cook recipes give you a time range to prevent overcooking. Set the oven for minimum time, test the food for doneness and cook the food a little longer, if necessary.

**Q. I touched the number pads and selected my power level. When I touched START, however, my oven didn't come on. Why not?**

**A.** The TIME COOK I & II pad must be touched before setting the power level otherwise your oven will not begin cooking.

**Q. I want to cook on a power level other than 10 (High). What do I need to do?**

**A.** To change power level, touch the POWER LEVEL pad, then touch desired number for new power level.

**Q. Can I interrupt Time Cook to check the food?**

**A. Yes.** To resume cooking, simply close the door and press the START pad. The timer must be reset for cooking to resume unless time is remaining on timer.



# COOKING BY TIME

(continued)

## How to Use Auto Start

The Auto Start feature allows you to program your oven to begin cooking at a preset time of day—up to a 12-hour delay.



**Step 1:** Touch AUTO START/REMINDER pad.

**Step 2:** Enter the time you want the oven to start. (Be sure your microwave oven clock shows the correct time of day.)

**Step 3:** Enter your desired cooking program.

**Step 4:** Touch START pad. The oven will automatically start at the desired time.

## How to Use Reminder

The Reminder feature can be used like an alarm clock, without starting the oven.

Example: It is 7 a.m. and you must remember to leave for a dentist appointment at 10 a.m.



**Step 1:** Touch AUTO START/REMINDER pad.

**Step 2:** Enter the time you want the oven to remind you. (Be sure your microwave oven clock shows the correct time of day. The reminder time can be set up to 12 hours later).

**Step 3:** Touch START pad. The reminder is now set at the time you programmed, and will signal you at that time with a beeping sound until you open the door or touch the CLEAR/OFF pad. The display will show REM until the oven door is opened or CLEAR/OFF is touched. The REMinder time may be displayed by touching the AUTO START/REMINDER pad. The time-of-day may be displayed by touching the CLOCK pad.



## Popcorn

The Popcorn feature is designed to be used only with prepackaged microwave popcorn weighing 3.0 to 3.7 ounces.



**Step 1:** Touch POPCORN pad.

**Step 2:** Touch START pad. Oven will signal and display remaining time counting down shortly before shut off.

## Light Microwave Popcorn

**Step 1:** Touch POPCORN pad.



**Step 2:** Touch number pad 2.

**Step 3:** Touch START pad.

## Adjust for Shorter or Longer Cook Time

If your favorite popcorn is undercooked, try this:

Touch the POPCORN pad. Touch number pad 1 for regular microwave popcorn or touch number pad 2 for light microwave popcorn. Touch renumber pad 9. A plus sign is displayed. The plus sign indicates 20 seconds is added to cooking time.



If your favorite popcorn is overcooked, try this:

Touch the POPCORN pad. Touch number pad 1 for regular microwave popcorn or touch number pad 2 for light microwave popcorn. Touch number pad 1. A minus sign is displayed. The minus sign indicates 20 seconds less cooking time is being provided.



# DEFROSTING BY TIME

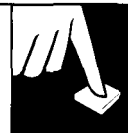

## Time Defrost

**Time Defrost** is designed for speedy thawing of frozen food and is one of the great advantages of a microwave oven.

Use the Time Defrost setting to quickly thaw foods such as bread, rolls, vegetables, fruits and frozen dinners.

- Power level 3 is automatically set for defrosting, but you may change this for more flexibility.

- See your Defrosting Guide for defrosting help.

To become better acquainted with the defrost function, defrost a 10 oz. package of frozen strawberries by following the steps below.

**Step 1:** Place package of frozen strawberries in the oven and close door. Be sure package contains no metal.



**Step 2:** Touch TIME DEFROST.

**Step 3:** Select one half of the total defrosting time recommended in the Defrosting Guide. For example, touch pads 4, 0 and 0 for 4 minutes.

### How to Change Power Level

After setting defrosting time, touch POWER LEVEL pad, then touch desired number for new power level.



**Step 4:** Touch START. When the cycle is completed, the oven signals and flashes "End," then automatically shuts off.

**Step 5:** Turn the package over, close the door and repeat Steps 2 and 3 to set remaining half of defrosting time and touch START.

**Step 6:** When the oven signals and flashes "End," open the door, remove the package and separate strawberries to finish defrosting.

## Defrosting Tips

- Foods frozen in paper or plastic can be defrosted in the package.

- For even defrosting, some foods need to be broken up or separated part of the way through the defrosting time.



- Family-size, pre-packaged frozen dinners can be defrosted and microwaved. If the food is in a foil container, transfer it to a microwave-safe dish.

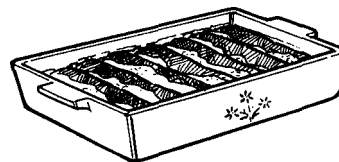

- Check your Defrosting Guide for other defrosting tips

## Questions and Answers

**Q. When I press START, I hear a dull, thumping noise. What is it?**

**A. This sound is normal.** It is letting you know the oven is using a power level lower than 10 (High).

**Q. Can I open the door during defrosting to check on the progress of my food?**

**A. Yes.** You may open the door at any time during microwaving. To resume defrosting, close the door and press START. The oven begins operating if time is left on timer. If not, reset timer.

**Q. Should all foods be completely thawed before cooking?**

**A. Some foods should not be completely thawed before cooking.** For example, fish cooks so quickly it is better to begin cooking while it is still slightly frozen.

**Q. Can I defrost small items in a hurry?**

**A. Yes,** but they will need more frequent attention than usual. Raise the power level after entering the time by touching the desired power level pad. Power level 7 cuts the total defrosting time in about 1/2; Power level 10 cuts the total defrosting time to approximately 1/3. During either, rotate or stir food frequently.

**Q. Why don't the defrosting times in the Defrosting Guide seem right for my food?**

**A. These times are averages.** Defrosting time can vary according to the temperature in your freezer. Set your oven for the time indicated in the Defrosting Guide. If your food is still not completely thawed at the end of that time, reset your oven and adjust the time accordingly.



# AUTO DEFROST

## Auto Defrost

With the Auto Defrost feature, the oven automatically sets the **defrosting times and power levels** for you.

Use the Auto Defrost guide on the next page. Enter the food weight in pounds and tenths of a pound (see Conversion Guide below). Then touch START pad.

The oven calculates defrosting time and changes power levels during defrosting to give even defrosting results.

## How to Set Auto Defrost

**Before you begin, check the guide located at front of oven when you open the door.** It shows minimum and maximum food weights for a variety of foods. You will need to know your food weight before setting Auto Defrost.

1. Remove food from package, place in oven on microwave-safe dish and close door.



2. Touch the AUTO DEFROST pad.

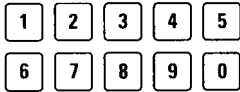

3. Enter weight. For example, touch number pads 1 and 2 for weight of 1.2 pounds ( 1 pound, 3 ounces. See Conversion Guide below.)



4. Touch START pad. Display shows defrost time counting down.

**Twice during defrosting, the oven beeps 4 times and "TURN" flashes.**

Follow the directions in the Auto Defrost Guide for what to do at the first beep and second signal. Then close the door and touch START. (Defrosting continues during "TURN" display.)

When defrosting time is completed, "End" flashes and oven beeps 4 times. "End" remains on display and oven beeps every minute until door is opened or CLEAR/OFF pad is touched.

## Stand Time

After Auto Defrosting, meat needs to stand in order to let the inside defrost. You may take the food out of the oven if you wish. Stand time recommendations are given in the guide on the next page.

### Conversion Guide

If the weight of food is stated in pounds and ounces, the ounces must be converted to tenths (.1) of a pound.

Ounces	Pounds
1-2	.1
3	.2
4-5	.3
6-7	.4
8	.5
9-10	.6
11	.7
12-13	.8
14-15	.9

# AUTO DEFROST GUIDE



1. Unwrap item being defrosted.
2. Place roasts and whole poultry on trivet in microwave-safe dish. Check food for warm spots halfway through defrosting, and shield these areas with small pieces of foil.

RECOMMENDED FOODS	MIN.-MAX. WEIGHT	INSTRUCTIONS	STAND TIME
<b>Meat</b>			
Chops	0.1 -6.0lbs.	Separate, turn over and shield where necessary.	5minutes
Frankfurters, Sausage	0.1 -6.0 lbs.	Separate and remove defrosted pieces.	2 minutes
Ground Meat	0.1 -6.0 lbs.	Turn over, remove defrosted areas and break apart.	5 minutes
Beef Patties	0.1 -6.0 lbs.	Turn over and separate patties. Remove defrosted pieces.	5 minutes
Roast	0.1 -6.0lbs.	Turnover and shield.	30-90 minutes
Ribs	0.1 -6.0 lbs.	Separate, turn over and remove defrosted pieces. Shield if necessary.	5 minutes
Steak	0.1 -6.0lbs.	Turn over and shield.	5 minutes
Stew	0.1 -6.0 lbs.	Separate and remove defrosted pieces.	5 minutes
<b>Poultry</b>			
Whole Chicken	0.1 -6.0 lbs.	Turn over and shield.	10 minutes; run cold water in cavity.
Turkey Breast (breast side up)	0.1 -6.0 lbs.	Turn over and shield.	20 minutes in refrigerator
Chicken Pieces	0.1 -6.0 lbs.	Separate and remove defrosted pieces.	5 minutes
Cornish hens (whole)	0.1 -6.0 lbs.	Turn over and shield where necessary.	10 minutes; run cold water in cavity.
Cornish hens (split)	0.1 -6.0 lbs.	Turn over and shield.	5 minutes
<b>Seafood</b>			
Fish fillets	0.1 -6.0lbs.	Separate and remove defrosted pieces.	5minutes
Shrimp, scallops	0.1 -6.0lbs.	Separate and remove defrosted pieces.	5minutes
Whole fish	0.1 -6.0 lbs.	Turn over and shield tail and head.	5 minutes; hold under cold running water.

Edges or thin areas of meat will defrost more rapidly than other areas. After first or second signal, shield warm areas with small pieces of foil.



# GLOSSARY OF MICROWAVE TERMS

**When adapting recipes for the microwave, it is best to start with a familiar recipe. Knowing how the food should look and taste will help when adapting recipes for microwaving. Foods that require browning or crisp, dry surfaces will cook better conventionally.**

- Moist foods, such as vegetables, fruits, poultry and seafood, microwave well.
- Rich foods, such as bar cookies, moist cakes and candies, are suitable for microwaving because of their high fat and sugar content.
- Reduce conventional cooking time by one-half to one-third. Check food after minimum time to avoid overcooking.
- Small amounts of butter or oil can be used for flavoring, but **are** not needed to prevent sticking.
- Seasonings may need to be reduced. Salt meats and vegetables after cooking.

**Covering.** In both conventional and microwave cooking, covers hold in moisture, allow for more even heating and reduce cooking time. Conventionally, partial covering allows excess steam to escape. Venting plastic wrap or covering with wax paper serves the same purpose when microwaving.

**Venting.** After covering a dish with plastic wrap, you vent the plastic wrap by turning back one corner so excess steam can escape.

**Arranging Food in Oven.** In conventional baking, you position foods, such as cake layers or potatoes, so hot air can flow around them. When microwaving, you arrange foods in a ring, so that all sides are exposed to microwave energy.

**Stirring.** In range-top cooking, you stir foods up from the bottom to heat them evenly. When microwaving, you stir cooked portions from the outside to the center. Foods that require constant stirring conventionally will need only occasional stirring when microwaving.

**Turning Over.** In range-top cooking, you turn over foods, such as hamburgers, so both sides can directly contact the hot pan. When microwaving, turning is often needed during defrosting or when cooking certain foods, such as frozen hamburgers.

**Standing Time.** In conventional cooking, foods such as roasts or cakes are allowed to stand to finish cooking or to set. Standing time is especially important in microwave cooking. Note that a microwaved cake is not placed on a cooling rack.

**Shielding.** In a conventional oven, you shield chicken breasts or baked foods to prevent over-browning. When microwaving, you use small strips of foil to shield thin parts, such as the tips of wings and legs on poultry, which would cook before larger parts.

**Arcing.** Sparks caused by too much metal in the microwave oven or metal touching the side of the oven or foil that is not molded to food.

**Prick Foods to Release Pressure.** Steam builds up pressure in foods that are tightly covered by a skin or membrane. Prick foods, such as potatoes (as you do conventionally), egg yolks and chicken livers, to prevent bursting.

**Rotating.** Occasionally, repositioning a dish in the oven helps food cook more evenly. To rotate 1/2 turn, turn the dish until the side that was to the back of the oven is to the front. To rotate 1/4 turn, turn the dish until the side that was to the back of the oven is to the side.

---

## Basic Microwave Guidelines

**Density of Food.** In both conventional and microwave cooking, dense foods, such as potatoes, take longer to cook than light, porous foods, such as rolls, bread or pieces of cake.

**Round Shapes.** Since microwaves penetrate foods to about one inch from top, bottom and sides, round shapes and rings cook more evenly. Corners receive more energy and may overcook. This may also happen when cooking conventionally.

**Delicacy.** Foods with a delicate texture, such as custards, are best cooked at lower power settings to avoid toughening.

**Natural Moisture** of food affects how it cooks. Very moist foods cook evenly because microwave energy is attracted to water molecules. Food that is uneven in moisture should be covered or allowed to stand so heat can disperse evenly.

**Piece Size.** Small pieces cook faster than large ones. Pieces that are similar in size and shape cook more evenly. With large pieces of food, reduce the power setting for even cooking.

**Shape of Food.** In both types of cooking, thin areas cook faster than thick areas. This can be controlled in microwaving by placing thick pieces near the outside edge and thin pieces in the center.

**Starting Temperature.** Foods taken from the freezer or refrigerator take longer to cook than foods at room temperature. Timings in our recipes are based on the temperatures at which you normally store the foods.

**Quantity of Food.** In both types of cooking, small amounts usually take less time than large amounts. This is most apparent in microwave cooking, where time is directly related to the number of servings.

**Shelf** (on models so equipped). Use the shelf to heat more than one dish at one time. Take the shelf out when you are not using it.



# MICROWAVE COOKWARE GUIDE & MICROWAVE ADAPTING

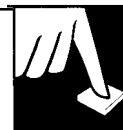

Type of Cookware	Microwave Uses
<b>Foil-lined paper bags and boxes</b>	Avoid using.
<b>Foil baking trays</b>	You can use foil trays that are no higher than 3/4-in. (Foil or metal will reflect microwaves and cause uneven heating.) Arcing can occur if foil is closer than 1 inch to oven walls.
<b>Aluminum foil</b>	Use for shielding.
<b>Metal or partially metal pots, pans, thermometers, skewers and twist ties</b>	Do not use. Microwave-safe thermometers and skewers are available.
<b>Glass jars and bottles</b>	Generally, glass jars can be used to warm food. However, do not heat baby food in jars, even without lids, because food will heat unevenly. Do not warm foods in narrow-necked bottles because pressure can build up.
<b>Microwave plastics</b>	Cooking and heating.
<b>Paper or Styrofoam plates and cups</b>	Heating and serving of foods and beverages. Styrofoam will melt if food is too hot or if food is cooked for a long time.
<b>Oven glass and ceramic</b>	Cooking and heating.
<b>Dinnerware</b>	Heating and some cooking. Follow dinnerware manufacturer's recommendations. Avoid using dishes with metal trim.
<b>Paper towels, paper napkins and wax paper</b>	Absorbing moisture, and preventing spatters. Heating and serving of sandwiches or appetizers. Light covering to hold in steam. Do not use paper towels that have synthetic fibers, such as nylon, woven into them. Synthetic fibers may cause the towel to ignite. Avoid using recycled paper.
<b>Plastic wrap, cooking bags, boil-in bags and storage bags</b>	Covering to hold in steam (wrap). Cooking (cooking and boil-in bags). Heating (storage bags).
<b>Paperboard trays used for frozen entrees and dinners</b>	Cooking and heating.
<b>Plastic trays and plates used for frozen entrees and dinners</b>	Cooking and heating.
<b>Straw, wicker and wood</b>	Warming.

## Cookware Tips

- Always check the cookware manufacturer's recommendations before using any cookware in the oven.
- Before purchasing cookware or preparing food in cookware, check its size to make sure it will fit in the oven.
- For best cooking results select a dish that matches the size or amount of food being prepared.



# HEATING OR REHEATING GUIDE

- Directions below are for heating or reheating already-cooked foods stored in refrigerator or at room temperature. Use microwave-safe cookware.
- Cover most foods for fastest heating. Exceptions are some sandwiches, griddle foods and baked items,
- Bubbling around edges of dish is normal, since the center is the last to heat. Foods heated to 160°F. to 165°F. will provide safe,

palatable results. Adjust temperatures to suit your personal taste. Let foods stand a few minutes before serving.

- Be sure foods are heated throughout before serving. Steaming or bubbling around edges of dish does not necessarily mean food is heated throughout.

If you use a meat thermometer while cooking, make sure it is safe for use in microwave ovens.

Item	Amount	Power Level	Time
<b>Appetizers</b>			
Dips: cream or processed cheese	1/2 cup	Medium (5)	2½ to 3½ min
	1 cup	Medium (5)	3 to 5 min.
Pastry bites: small pizzas, egg rolls, etc.	2 to 4 servings	High (10)	2 to 4 min
<b>Saucy:</b> meatballs, riblets, cocktail franks, etc. (1/2 cup per serving)	1 to 2 servings	High (10)	2 to 4 min.
	3 to 4 servings	High (10)	5 to 7 min.
<b>Tip:</b> Cover saucy appetizers with wax paper. Cover dips with plastic wrap. Microwave pastry bites uncovered to retain their crispness.			
<b>Bakery Foods</b>			
<b>Cake, coffee cake, doughnuts, sweet rolls, nut or fruit bread</b>	1 piece	Low (3)	1/2 to 1 min.
	2 pieces	Low (3)	1 to 1½ min.
	4 pieces	Low (3)	1½ to 2½ min.
	9-in. cake or 12 rolls or doughnuts	Low (3)	2 to 4 min.
<b>Dinner rolls, muffins</b>	1	Medium (5)	1/4 to 1/2 min
	2	Medium (5)	1/2 to 1 min.
	4	Medium (5)	1 to 1½ min.
	6 to 8	Medium (5)	1 to 2 min.
Pie: fruit, nut or custard 1 slice= 1/8 of 9-in. pie (use minimum time for custard)	1 slice	High (10)	1/2 to 1 min.
	2 slices	High (10)	1 to 1½ min.
	4 slices	Meal-High (7)	2½ to 3 min.
	9-in. pie	Meal-High (7)	5 to 7 min.
<b>Beverages</b>			
<b>Cocoa, other milk based</b> (6 oz./cup) (9 oz./cup)	1 to 2 cups	Meal-High (7)	3 to 6 min.
	1 to 2 cups	Meal-High (7)	5 to 7 min.
<b>Coffee, tea, cider</b> (6 oz./cup) (9 oz./cup)	1 to 2 cups	High (10)	1 to 3 min.
	1 to 2 cups	High (10)	6 to 7 min.
<b>Gravies &amp; Sauces</b>			
<b>Desserts:</b> chocolate, butterscotch, etc.	1/2 cup	High (10)	1 to 2 min.
	1 cup	High (10)	2 to 3 min.
<b>Gravies:</b> giblet or creamy	1/2 cup	High (10)	1 to 2 min.
	1 cup	High (10)	2 to 3 min.
<b>Meat or main dish sauces,</b> such as spaghetti sauce, etc.	1/2 cup	High (10)	2 to 3 min.
	1 cup	High (10)	3 to 4 min.
	1 can (16 oz.)	High (10)	3 to 4 min.
<b>Tip:</b> Cover food to prevent spattering.			
<b>Griddle Foods</b>			
<b>Pancakes, french toast or waffles:</b> Plain, no topping Syrup & butter	2 or 3 pieces	High (10)	1 to 1½ min.
	2 or 3 pieces	High (10)	1 to 1¼ min.
<b>Tip:</b> Do not cover.			



Item	Amount	Power Level	Time
<b>Meats and Main Dishes</b>			
<b>Chicken pieces</b>	<b>1 to 2</b> pieces 3 to 4 pieces	High ( lo) High ( 10)	2 to 3 min. 3 to 4 min.
<b>Hamburgers or meatloaf</b> (4 oz. per serving)	<b>1 to 2</b> servings 3 to 4 servings	High ( 10) High ( 10)	2 to 3 min. 4 to 5 min.
<b>Hot dogs and sausages</b>	<b>1 to 2</b> 3 to 4	High ( 10) High ( 10)	1/2 to 1 min. 1 to 2 min.
<b>Rice and pasta</b> (2/3-3/4 cup per serving)	<b>1 to 2</b> servings	High ( 10)	1 to 3 min.
<b>Saucy, main dishes:</b> chopsuey, spaghetti, creamed chicken, chili, stew, macaroni and cheese, etc. (3/4- 1 cup per serving)	1 to 2 servings 3 to 4 servings 1 can (16 oz. )	High ( 10) High ( 10) High ( lo)	3 to 5 min. 6 to 9 min. 5 to 7 min.
<b>Steaks, chops, ribs, meat pieces</b>	<b>1 to 2</b> servings 3 to 4 servings	Meal-High (7) Meal-High (7)	2 to 4 min. 5 to 7 min.
<b>Thinly-sliced meat</b> (3 to 4 oz. per serving)	1 to 2 servings 3 to 4 servings	Meal-High (7) Meal-High (7)	1 to 3 min. 2 to 5 min.
<b>Topped or mixed with sauce</b> (~3/3.3/4 cup per serving)	<b>1 to 2</b> servings 3 to 4 servings	High ( 10) High ( 10)	3 to 5 min. 5 to 6 min.
<b>Tip:</b> Cover saucy main dishes with plastic wrap. Cover other main dishes and meats with wax paper. When heating or reheating 3 to 4 servings of meat slices or pieces, rotate dish 1/2 turn after half of cooking time.			
<b>Plate of Leftovers</b>			
<b>Meat</b> plus 2 vegetables	1 plate	High ( lo)	3 to 4 min.
<b>Tip:</b> Cover plate of food with wax paper or plastic wrap.			
<b>Sandwiches</b>			
<b>Meat-cheese filling:</b> with 2 slices of bread	1 to 2 servings 3 to 4 servings	Meal-High (7) Meal-High (7)	1 to 3 min. 3 to 4 min.
<b>Moist filling:</b> Sloppy Joes, barbecue, ham salad, etc. in bun (1/3 cup per serving)	1 to 2 servings 3 to 4 servings	Meal-High (7) Meal-High (7)	1 to 2 min. 2 to 3 min.
<b>Tip:</b> Use paper towel or napkin to cover sandwiches.			
<b>soups</b>			
<b>Milk-based</b> (6 oz. per serving)	1 to 2 servings 3 to 4 servings 1 can (10 oz. )	Meal-High (7) Meal-High (7) Meal-High (7)	2 to 3 min. 5 to 7 min. 6 to 7 min.
<b>Water-based</b> (6 oz. per serving)	1 to 2 servings 3 to 4 servings 1 can (10 oz. )	High ( 10) High ( 10) High ( 10)	1 1/2 to 3 min. 4 to 6 min. 4 to 5 min.
<b>Tip:</b> Cover soups with wax paper or plastic wrap.			
<b>Vegetables</b>			
<b>Large pieces or whole:</b> asparagus spears, corn on the cob, etc.	1 to 2 servings 3 to 4 servings 1 can (16 oz. )	High ( lo) High ( 10) High ( 10)	1 to 2 min. 2 to 3 min. 4 min.
<b>Mashed</b> (1/2 cup per serving)	<b>1 to 2</b> servings 3 to 4 servings	High ( 10) High ( 10)	1 to 2 min. 3 to 4 min.
<b>Small pieces:</b> peas, beans, corn, etc. (1/2 cup per serving)	1 to 2 servings 3 to 4 servings 1 can (16 oz. )	High ( 10) High ( 10) High ( 10)	1 to 2 min. 2 to 3 min. 2 to 4 min.
<b>Tip:</b> Cover vegetables for most even heating.			



# DEFROSTING GUIDE

1. Food packaged in paper or plastic may be defrosted without unwrapping. If food is foil wrapped, remove foil and place food in cooking dish for defrosting. Most food defrosts well using Defrost (3). For more even defrosting of larger foods, such as beef, lamb and veal roasts, use Warm (1).
2. After first half of defrosting time, unwrap package and check food. Turn food over, if necessary; break apart or separate food if possible. Shield any warm areas with small pieces of foil.
3. Be sure large meats are completely defrosted before cooking.
4. When defrosted, food should be cool but softened in all areas. If still slightly icy, return to microwave oven very briefly, or let stand a few minutes.

Food	<u>First Half</u> Time, Min.	<u>Second Half</u> Time, Min.	Comments
<b>Breads, Cakes</b> [Power Level: Defrost (3)]			
<b>Bread, buns or rolls</b> (8 to 16 oz.)	2 to 3	1 to 2	Remove metal twist tie. Turn over after first half of time.
<b>Cake, frosted, 2 to 3 layer</b> (17 oz.)	2 to 3	none	Let stand 5 to 10 minutes before serving.
<b>Cake, plain, 1 layer</b>	2 to 3	none	Let stand 5 minutes before serving.
<b>Cheesecake, plain or fruit-topped</b> (17 to 19 oz.)	3 to 6	none	
<b>Coffee cakes</b> (1 1/2 to 1 3/4 oz.)	6 to 7	none	
<b>Cream or custard pie</b> (14 oz.)	1 to 2	1 to 2	Reposition after first half of time. Let stand 5 minutes before serving.
<b>Crunch cakes &amp; cupcakes</b>	1/2 to 3/4 each	none	
<b>Doughnuts</b>			
<b>(1 or 2)</b>	1/2 to 1	none	Rearrange after first half of time.
<b>(4 to 6)</b>	1 to 2	1 to 2	
<b>French toast (2 slices)</b>	2	1	Turn over after first half of time.
<b>Fruit or nut pie</b> (8 in.)	7 to 9	none	
<b>Pound cake (1 1/2 oz.)</b>	2 to 4	none	Let stand 5 minutes before serving.
<b>Sweet rolls</b> (8 3/4 to 12 oz.)	2 to 3	2 to 3	Rearrange after first half of time.
<b>Fish &amp; Seafood</b> [Power Level: Defrost (3)]			
<b>Filletts:</b>			
Pre-packaged (1 lb.)	4 to 5	5 to 7	Place <b>unopened package</b> in oven. (If fish is frozen in water, place in cooking dish.) Turn package over after first half of time. After second half of time, hold under cold water to separate.
Freshly frozen (1 lb.)	4 to 5	5 to 7	
<b>Shellfish, blocks:</b>			
Crab meat (6-oz. package)	2	2	Place block in casserole. Turn over and break up with fork after first half of time.
Oysters (12-oz. can)	4 to 6	4 to 6	Place block in casserole. Breakup with fork after first half of time.
Scallops (1-lb. package)	4 to 6	4 to 6	Place block in casserole. Turn over and break up after first half of time.
<b>Shellfish, large:</b>			
Crab legs, 1 to 2 (8 to 10 oz.)	2 to 3	2 to 3	Arrange in cooking dish with light-underside-up. Turn over after first half of time.
Lobster tails, 1 to 2 (6 to 9 oz.)	3 to 4	3 to 4	Arrange in cooking dish, with meaty-side-down. Turn over after first half of time.
<b>Shellfish, small pieces</b> (1 lb.)	3 to 4	3 to 4	Spread shellfish in single layer in baking dish. Rearrange pieces after first half of time.
<b>Steaks (6 to 12 oz.)</b>	2 to 3	none	Let stand a few minutes to finish defrosting.
<b>Whole fish</b> (8 to 10 oz.)	3	2 to 4	Place fish in cooking dish, Turn over after first half of time. After second half of time, rinse cavity with cold water to complete defrosting.



Food	<u>First Half</u> <u>Time, Min.</u>	<u>Second Half</u> <u>Time, Min.</u>	Comments
<b>Fruit</b> [Power Level: Defrost (3)]			
<b>Fresh (10 to 16 oz.)</b>	2 to 3	2 to 3	Place package in oven. Remove foil or metal. After minimum time, break up with fork. Repeat if necessary.
Plastic pouch—1 to 2 (10-oz. package)	1 to 3	3 to 4	Place package in oven. Flex package once.
<b>Meat</b> [Power Level: Defrost (3)]			
<b>Bacon</b> (1lb.)	2 to 3 per lb.	2 to 3 per lb.	Place unopened package in oven. Let stand 5 minutes after defrosting.
<b>Franks</b> (1lb.)	2 to 3	2 to 3	Place unopened package in oven. Microwave just until franks can be separated. Let stand 5 minutes, if necessary, to complete defrosting.
<b>Ground:</b> beef & pork (1 lb.)	3 to 4	3 to 4	Turn meat over after first half of time.
(2 lbs.)	6 to 7	6 to 7	Turn meat over after first half of time. Scrape off softened meat after second half of time. Set aside, Break up remaining block and microwave 1 to 2 minutes more.
(5 lbs.)	12 to 13	12 to 13	Turn meat over after first half of time. Scrape off softened meat after second half of time. Set aside. Microwave 6 to 8 minutes more. Scrape and set aside. Break up remaining block and microwave 3 to 5 minutes more.
<b>Roast:</b> beef, lamb, veal* (3 to 4 lbs.)	8 to 10 per lb.	8 to 10 per lb.	Place unwrapped roast in cooking dish. Turn roast over after first half of time. Defrost for second half of time. Let stand for 30 minutes to 1 hour in refrigerator.
<b>Roast,</b> pork (3 to 4 lbs.)	6 to 8 per lb.	4 to 6 per lb.	Place unwrapped roast in cooking dish. Turn roast over after first half of time. Defrost for second half of time. Let stand for 30 minutes to 1 hour in refrigerator.
<b>Sausage,</b> bulk (1-lb. tray)	2 to 3	2 to 4	Turn over after first half of time. Let stand 5 minutes.
(1-lb. roll)	2 to 3	3 to 4	Turn over after first half of time. Let stand 15 minutes.
<b>Sausage,</b> links (1 to 1 1/2 lbs.)	2	1 1/2 to 2 1/2	Rotate package 1/4 turn after first half of time. Let stand 5 minutes.
<b>Sausage,</b> patties (12-oz. package)	2	2 to 3	Turn over and separate after first half of time. Remove patties as they thaw.
<b>Spareribs,</b> pork (2 to 3 lbs.)	2 to 4 per lb.	2 to 4 per lb.	Place unwrapped ribs in cooking dish. Turn over after first half of time. After second half of time, separate pieces with table knife. Let stand to complete defrosting.
<b>Steaks,</b> chops & cutlets	3 to 5 per lb.	3 to 5 per lb.	Place unwrapped meat in cooking dish. Turn over after first half of time and shield warm areas with foil. After second half of time, separate pieces with table knife. Let stand to complete defrosting.
*Use <b>Warm (1)</b> for roasts.			
<b>Poultry</b> [Power Level: Defrost (3)]			
<b>Chicken,</b> broiler-fryer, cut up (2 1/2 to 3 lbs.)	9 to 11	9 to 11	Place wrapped chicken in dish. Unwrap and turn over after first half of time. After second half of time, separate pieces and place in cooking dish. Microwave 2 to 4 minutes more, if necessary. Let stand a few minutes to finish defrosting.
<b>Chicken,</b> whole (2 1/2 to 3 lbs.)	12 to 14	12 to 14	Place wrapped chicken in dish. After first half of time, unwrap and turn chicken over. Shield warm areas with foil. To complete defrosting, run cool water in cavity until giblets can be removed.
<b>Cornish</b> hen	5 to 6 per lb.	5 per lb.	Place unwrapped hen in oven breast-side-up. Turn over after first half of time. Run cool water in cavity until giblets can be removed.
<b>Duckling</b>	4 to 6 per lb.	4 to 6 per lb.	Place unwrapped duckling in oven. Turn over after first half of time. Shield warm areas with foil. Run cool water in cavity until giblets can be removed.
<b>Turkey breast</b> (4 to 6 lbs.)	3 to 5 per lb.	3 to 5 per lb.	Place unwrapped breast in microwave-safe dish breast-side-down. After first half of time, turn breast-side-up and shield warm areas with foil. Defrost for second half of time. Let stand 1 to 2 hours in refrigerator to complete defrosting.



# COOKING GUIDE

## Breads

**Crust** on breads will be soft and the outsides will not brown. If desired, sprinkle top of batter with cinnamon-sugar mixture, chopped nuts or other topping for brown color. To increase brown

color on upside-down breads, line dish before microwaving with brown sugar-caramel mixture or savory topping, such as crushed, canned, french fried onion rings.

Food	Container	Cover	Power Level & Time	Comments
<b>Coffee cakes</b>	8 in. round or square dish	No	Med-High (7) 8 to 10 min.	Place batter in greased dish
<b>Corn bread</b>	8 to 9 in. tube dish*	No	Meal-High (7) 9 to 11 min.	Sprinkle cooking dish with finely chopped, canned, french fried onions before microwaving. Turn out of pan upside down to serve.
<b>Muffins</b> (1 Muffin) (2 to 4 Muffins) (3 to 6 Muffins)	Paper-lined muffin cups (Do not use foil liners,)	No	High (10) 1 to 1 1/2 min. 1 to 2 min. 2 to 4 min.	Use microwave-safe muffin container or homemade muffin cups, made by cutting down hot drink paper cups. Some muffins may be done before others. Remove muffins as they are done, and continue cooking remaining muffins a few seconds longer.
<b>Quick breads,</b> from a mix	Glass loaf dish	No	Meal-High (7) 11 to 16 min.	Shield corners after half of cooking time. When done, toothpick inserted in center will come out clean. Let stand 15 minutes before turning out of dish. Cool.

\*If tube dish is unavailable, microwave in 8 in. round dish with drinking glass placed open-side-up in center.

## Cakes and Desserts

1. Always use microwave-safe cookware.
2. Before adding measured amount of batter, grease dishes or line them with wax paper. (Do not flour.)
3. Cakes are done when toothpick or long skewer inserted into center comes out clean.
4. **Cool** cake in dish set directly on heat-proof surface or wooden board 10 to 15 minutes before inverting.
5. Crust on cakes will be soft. If cake is to be frosted, refrigerate cake for an hour to firm exterior surface.
6. Chiffon and Angel Food cakes are not recommended for microwaving.

Food	Container	Cover	Power Level & Time	Comments
<b>Baked apples or pears</b>	Microwave-safe dish or casserole	Lid or plastic wrap	High (10) 2 to 4 min. per piece	Pierce fruit or peel to prevent bursting. Core and fill center of apple with 2 tablespoons sugar, 1 teaspoon butter and 1/8 teaspoon cinnamon. Add 2 tablespoons water for each piece of fruit.
<b>Bar cookies</b>	8 in. square dish	No	High (10) 5 to 7 min.	Grease dish before adding batter. Cut when cool.
<b>Commercial mix</b> (18 to 20 oz.)	8 in. round or square dish	No	High (10) Meal-High (7) 2 min. 4 to 6 min.	Grease dish before adding batter. Let stand 5 to 10 minutes to cool before inverting.
<b>Cupcakes—6</b>	Fluted tube cake pan Paper-lined cupcaker	No	High (10) 11 to 13 min. 2 1/2 to 3 min.	Let tube cake stand 15 to 20 minutes to cool, before inverting. When cooking several cupcakes, some will be done before others. Remove cupcakes as they are done and continue cooking remaining cupcakes a few seconds longer.
<b>Pineapple upside down cake</b>	8 in. round dish	No	High (10) 10 to 12 min.	When done, toothpick stuck in cake comes out clean. Invert cake onto plate; let dish stand over cake a few minutes.



## Candies

1. Always use microwave-safe cookware. For easy clean-up, melt chocolate in paper wrappers seam-side-up, or place chocolate in paper bowl to melt.

2. Candies which are boiled become very hot; handle cookware carefully.

Food	Container	Cover	Power Level & Time	Comments
<b>Caramel apples</b>	1 pint (2-cup) measure	No	High ( 10) 3 min.	Unwrap a 14-oz. package of caramels into measuring cup. <b>Add 1 tablespoon water. Microwave, stirring every minute. Dip 4 apples into mixture.</b>
<b>Chocolate bark</b>	1½-qt. casserole or bowl	Yes	High (10) 3 to 5 min.	Place 12 oz. semi-sweet chocolate pieces in container. Microwave to melt. Add 1 cup whole toasted almonds Spread over wax paper on cookie sheet. Chill until firm.
<b>Marshmallow crisp</b>	2-qt. oblong dish	Yes	High (10) 1½ min. to melt butter, ¾ min. to melt marshmallows	In large glass bowl, melt ¼ cup butter. Add 10-oz. package marshmallows, cover with wax paper and microwave to melt. Stir in 5 cups crispy rice cereal. Press firmly into buttered dish.
<b>S'Mores</b>	Paper napkin or paper plate	No	High ( 10) 15 to 25 seconds	Cover graham cracker with chocolate and marshmallow.

## Cereal, Pasta and Rice

1. Always use microwave-safe cookware.

2. For pasta, use about one-half the amount of water needed for conventional boiling. Add regular amount of salt and 1 teaspoon oil (optional, to prevent sticking).

3. For rice or minute rice, use the same amount of water needed for conventional boiling. Add regular amount of salt.

4. Cover pasta and rice while microwaving. When using plastic wrap, turn back one corner to vent.

5. Stir or rearrange after half of cooking time. Drain pasta immediately after microwaving.

6. Microwave time and conventional boiling time are about the same.

Food	Container	Cover	Power Level & Time	Comments
<b>Oatmeal, old fashioned</b>	1-qt. casserole or bowl	No	High ( 10) 3 to 5 min. per serving	Increase casserole size for more than one serving. Increase time about 1 ½ minutes for each additional serving you are cooking. Stir after half of cooking time.
<b>Rice, minute (1½ cups)</b>	2-qt. casserole	Lid or plastic wrap	High (10) 2 to 3 min.	<b>Add 1½ cups water. Stir after 2 minutes</b>
<b>Rice, regular long grain (1 cup)</b>	3-qt. casserole	Lid or plastic wrap	High ( 10) 18 to 21 min.	<b>Add 2¼ cups water. Stir after 10 minutes.</b>
<b>Spaghetti (16 oz.)</b>	2-qt. oblong dish	Plastic wrap	High ( 10) 16 to 19 min.	<b>Add 6 to 7 cups water. Rearrange after 10 minutes.</b>

**Note:** To microwave single-serving packet of instant oatmeal, follow package directions for amount of water and microwave at High ( 10) for 1/2 to 1 minute.

(continued next page)



# COOKING GUIDE

(continued)

## Cheese and Eggs

1. Eggs may be prepared many ways in the microwave oven. Always pierce whole yolks before microwaving to prevent bursting.
2. Never cook eggs in the shell. Do not reheat hard cooked eggs in the shell. They will explode.
3. Cook eggs just until set. They are delicate and can toughen if overcooked.

Food	Container	Cover	Power Level & Time	Comments
<b>Cheese</b>				
<b>Fondue</b>	Microwave-safe 2-qt. dish	Cover or plastic wrap	High ( 10) Medium (5)	To make sauce 3 to 5 min. 8 to 9 min. Make basic white sauce, substituting wine for milk. Add cheese and microwave at Medium (5) for 8 to 9 minutes, whisking every 2 minutes.
<b>Eggs</b>				
<b>Basic eggs</b>	Buttered custard cup	Plastic wrap	Medium (5)	1 to 1 ¼ min. per egg Puncture membrane of yolk to prevent bursting.
<b>Omelet</b>	9 in. pie plate	No	High ( 10) High (10)	Melt butter 1/2 to ¾ min. 1 to 2 min. Sprinkle cheese over omelet. Microwave 1/2 to 1 minute until cheese is slightly melted.
<b>Poached eggs</b>	1½-qt. casserole	Casserole cover	High (10) Medium (5)	5 to 6 min. Boil 2 cups water. 1/2 to 1 min. per egg Heat 2 cups hot tap water 5 to 6 minutes on High ( 10). Break eggs onto plate, puncture membrane. Swirl boiling water with spoon, slip in eggs gently. Cover. Microwave at Medium (5) 1/2 to 1 minute per egg. Let stand in water a few minutes.
<b>Quiche</b>	9 in. pie plate	No	Meal-High (7)	17 to 22 min. Pour filling into precooked 9-inch pie shell.
<b>Scrambled</b>	Glass measuring cup or casserole	No	High (10)	¾ to 1 min. per egg Scramble eggs with 1 teaspoon butter and 1 tablespoon milk per egg. Place in oven and microwave for half of total time. Stir set portions from the outside to the center. Allow to stand 1 or 2 minutes to finish cooking.

## Fish and Seafood

1. Fish is done when it flakes easily when tested with a fork. Center may still be slightly translucent, but will continue cooking as fish stands a few minutes after cooking.
2. Cook fish with or without sauce. A tight cover steams fish. Use a lighter cover of wax paper or paper towel for less steaming.
3. Do not overcook fish. Check at minimum time.

Food	Container	Cover	Power Level & Time	Comments
<b>Clams, 6</b>	Pie plate or shallow dish	Plastic wrap	High ( 10)	4 to 7 min. Place in dish with hinged side out.
<b>Filletts or steaks (1lb.)</b>	Oblong dish	Wax paper or plastic wrap	High (10)	5 to 7 min. Microwave until fish flakes easily, Turn steaks over after half of cooking time.
<b>Shrimp—1 lb. (peeled)</b>	Pie plate or shallow dish	Plastic wrap	High (10)	7 to 9 min. Brush with garlic butter before cooking. Rearrange after 4 minutes.
<b>Shrimp—1 lb. (unpeeled)</b>	2-qt. casserole	Lid or plastic wrap	High ( 10)	5 to 9 min. Place shrimp in casserole. Add 2 cups hottest tap water. Cover. Stir after 5 minutes.
<b>Whole fish</b>	Oblong dish	Plastic wrap	High (10)	5 to 7 min. per lb. Shield head and thin tail with aluminum foil.





# Gravies & Sauces

- Cover thick, chunky sauces to prevent spattering.
- Whisk sauces vigorously with wire whisk once or twice while microwaving.
- Vary basic white sauce by adding cheese, egg yolks, cream, wine or herbs.

Food	Container	Cover	Power Level & Time	Comments
<b>Gravies and sauces</b> thickened with flour or cornstarch (1 cup)	Casserole	No	Medium (5) 4 to 7 min.	Microwave fat, flour and salt together to melt and blend. Whisk in liquid and finish microwaving. Increase time 1 to 2 minutes per additional cup of sauce.
<b>Melted butter sauces</b> , clarified butter (1/2 cup)	Glass measure	No	High (10) 1 to 2 min.	Microwave butter just to melting. For clarified butter, bring to boil then let stand until layers separate. Pour off and use clear, top layer.
<b>Thick spaghetti, barbecue or sweet/sour sauces</b> (2 cups)	Casserole, bowl	Yes	High (10) 5 to 7 min.	Stir ingredients together, then microwave, stirring after half of cooking time. Let stand 5 to 10 minutes to develop flavor.
<b>Thin, liquid sauces</b> (au jus, clam, etc.) (1 cup)	Casserole	No	High (10) 3 to 4 min.	Add cornstarch-water mixture to heated ingredients. Stir well and microwave to finish.

# Meats

- Always use a cooking bag when cooking beef, lamb, pork or veal roasts. See package instructions for proper use of cooking bag.
- After enclosing roast in cooking bag, place on trivet in microwave-safe dish.
- Allow about 10 minutes standing time for most roasts before carving.

If you use a meat thermometer while cooking, make sure it is safe for use in microwave ovens.

Food	Container	Cover	Power Level & Time	Comments
<b>Beef</b>				
<b>Ground, crumbled</b> (for casseroles or soup)	Casserole	No	High (10)	Stir after half of cooking time. Add sauce or casserole ingredients and finish. To cook frozen block, microwave 10 to 15 minutes, breaking up and stirring every 5 minutes.
(1 lb.)			5 to 7 min.	Let stand 5 minutes.
(1 1/2 lbs.)			7 to 9 min.	
<b>Meatballs</b> (1 lb.)	Round dish or oblong dish	Wax paper or plastic wrap	High (10)	Round dish: arrange 3/4 to 1 in. apart in circle around edge of dish.
(2 lbs.)			6 to 8 min.	Oblong dish: arrange 3/4 to 1 in. apart. Rearrange after half of cooking time.
			9 to 12 min.	
<b>Meatloaf</b> (round loaf) (loaf shape)	Pie plate or loaf dish	Plastic wrap	Meal-High (7) or cook to 170°F.	Let stand 10 minutes after cooking
			15 to 20 min.	Let stand 10 minutes after cooking.
			25 to 30 min.	
<b>Patties</b> (4 patties per lb.)	Oblong glass dish (with trivet if desired) or ceramic dinner plate	Wax paper	High (10)	Cover with wax paper or cook uncovered and turn patties over. If desired add browning sauce.
1 to 2 patties			3 to 5 min.	
3 to 4 patties			4 to 6 min.	
<b>Pot roasts</b>	Oblong dish or casserole	Cooking bag	Low (3)	Brush with browning sauce and add 1/2 cup water to cooking bag. Turn over after half of time. Add vegetables if desired after half of cooking time. Recover and finish.
			24 to 29 min. per lb.	

(continued next page)



# COOKING GUIDE

(continued)

## Meats (continued)

Food	Container	Cover	Power Level & Time (or Internal Temp.)		Comments	
<b>Beef</b> (continued)						
<b>Simmered beef</b> (corned beef or brisket)	Casserole	Lid or plastic wrap	Medium (5)	120 to 130 min.	Add 1 cup water per pound of meat. Turn over after half of cooking time. Let meat stand in broth at least 10 minutes after cooking. For boiled dinner, remove meat and cook vegetables in broth.	
<b>Tender roasts</b> (rib, high quality rump, sirloin tip)	Oblong dish	Cooking bag	Medium (5)	<b>Minutes per lb.</b>	<b>Internal Temp.</b>	Turn roasts over after half of cooking time. Let meat stand 10 minutes before carving.
			Rare	11 to 14	140°F.	
			Medium	14 to 17	160°F.	
Well	17 to 20	170°F.				
<b>Lamb</b>						
<b>Roast</b> , leg or shoulder	2-qt. oblong dish and trivet	Cooking bag	Medium (5)	<b>Minutes per lb.</b>	<b>Internal Temp.</b>	Place roast fat-side-down in microwave-safe dish. Turn over after half of cooking time. Let roast stand 10 minutes before carving.
			Medium	11 to 15	160°F.	
Well	12 to 16	170°F.				
<b>Chops</b> (1 in. thick) 4 chops	2-qt. oblong dish	No	Meal-High (7)	6 to 9 min.	Brush chops lightly with oil. Turn meat over after half of cooking time.	
<b>Pork</b>						
<b>Bacon</b> (per slice)	Microwave-safe plate or oblong dish	Paper towel	High (10)	3/4 to 1 min.	Arrange in single layer on paper towels or on trivet set in dish. Cover with a paper towel. To microwave more than 1 layer of bacon, use an oblong dish and place a paper towel between each layer of bacon. Cover with a paper towel to prevent spatters.	
<b>Canadian bacon</b> 2 slices 4 slices 6 slices	Microwave-safe cookware	Wax paper	High (10)	1 to 1½ min.	Arrange in single layer.	
				2 to 2½ min.		
				2½ to 3 min.		
<b>Ham, precooked:</b> canned, butt or shank	2-qt. oblong dish	Cooking bag	Medium (5)	15 to 19 min. per lb.	Place fat-side-down in dish. Turn ham over after half of cooking time.	
<b>Ham, slices &amp; steaks</b> (1 to 2 in. thick)	2-qt. oblong dish	Wax paper	High (10)	10 to 15 min.	Turn over or rearrange after 10 minutes.	
<b>Pork chops: 1 in.</b> 2 4 6	Microwave-safe cookware	Plastic wrap	Medium (5)	10 to 13 min.	Brush with barbecue sauce or browning agent, if desired. Turn over after half of cooking time. Let stand covered 5 to 10 minutes before serving.	
				13 to 16 min.		
				16 to 19 min.		
<b>Pork roast</b>	2-qt. oblong dish	<b>Cooking bag</b>	Medium (5)	15 to 19 min. per lb.	Turn roast over after half of cooking time. Microwave to an internal temperature of 170°F.	
<b>Pork sausage</b> (raw), link	Microwave-safe cookware	Wax paper	High (10)	1/2 to 3/4 min. per link	Arrange in single layer. If cooking 6 or more links, rearrange after half of cooking time.	
<b>Pork sausage (raw)</b> (1/2 lb.: 4 patties)	Microwave-safe cookware	Wax paper	High (10)	3 to 5 min.	Arrange in single layer. Turn over after half of cooking time.	
<b>Veal</b>						
<b>Chops</b> (1 in. thick) 4 chops	2-qt. oblong dish	No	Meal-High (7)	6 to 9 min.	Brush chops lightly with oil. Turn meat over after half of cooking time.	
<b>Roast</b> (shoulder)	2-qt. oblong dish	Cooking bag	Medium (5)	17 to 21 min. per lb.	Place roast fat- or cut-side-down. Turn over after half of cooking time. Let roast stand 10 minutes before carving. Slice thinly.	



# Poultry

Let **turkey** breast and other poultry stand for 5 to 10 minutes after microwaving

If you **use** a meat thermometer while cooking, make sure it is safe for use in microwave ovens.

Food	Container	Cover	Power Level & Time	Comments	
<b>Chicken</b>					
<b>Pieces</b> (per piece)	Plate or oblong dish	Wax paper	High ( 10)	2½ to 3 min.	Arrange in single layer in cooking dish so thickest meaty pieces are to outside edges of dish. Turn pieces over and rearrange after half of cooking time.
<b>Whole chicken</b> (8 pieces) (unstuffed)	Oblong dish	Wax paper	High ( 10)	11 to 13 min. total	
(stuffed)	Oblong dish	Cooking bag	Meal-High (7)	10 to 12 min. per lb.	Brush with browning agent, if desired. Slit bag near closure to vent. Close securely with plastic tie. Cook breast-side-down. Turn over after half of cooking time. Cook to 190°F. internal temperature.
	Oblong dish	Cooking bag	Meal-High (7)	13 to 16 min. per lb.	
<b>Cornish Hens</b>					
<b>Halves</b>	Square or oblong dish	Wax paper	Meal-High (7)	12 to 14 min. per lb.	Arrange skin-side-up in dish. on bed of stuffing, if desired.
<b>Whole</b> (stuffed or unstuffed)	Square or oblong dish	Wax paper	Meal-High (7)	13 to 15 min. per lb.	Place breast-side-down in dish. Turn over after half of cooking time. Shield tips of wings and legs with foil.
<b>Duckling</b>					
	Oblong dish and trivet	Cooking bag	High ( 10)	6 to 8 min. per lb.	Microwave breast-side-down for first half of cooking time. <b>Brush with</b> browning sauce or broil top surface of cooked bird until brown and crisp.
<b>Turkey</b>					
<b>Turkey breast</b>	Oblong dish	Cooking bag	Medium (5)	13 to 15 min. per lb.	Tie ribs to breast cavity. Place breast in cooking bag. Close securely with plastic tie. Place breast-side-down in dish. Slash bag on underside near closure to vent. Turn over after half of cooking time.

# Vegetables

1. Always use microwave-safe cookware.
2. Salt vegetables after cooking. Salting before cooking may cause darkening and dehydration of surface.
3. Arrange **vegetables, such as asparagus, with the thickest pieces** to the outside of the dish.
4. Cover vegetables when cooking. If using plastic wrap, turn back one corner to vent.
5. Larger vegetable pieces will take longer to cook than smaller pieces.
6. For more even heating, stir, rearrange or rotate vegetables during cooking.

Vegetable	Amount	Power Level	Time	Comments
<b>Asparagus</b> (fresh cuts)	1 lb. (3 cups) cut into 1 to 2 in. pieces	High ( 10)	X to 10 min.	In 2-qt. casserole, place 1/4 cup water.

(continued next page)



# COOKING GUIDE

(continued)

## Vegetables (continued)

Vegetable	Amount	Power Level	Time	Comments
<b>Asparagus</b> (continued)				
(fresh spears)	1 lb.	Meal-High (7)	8 to 10 min.	In 1 1/2-qt. oblong glass baking dish, place 1/4 cup water. Rotate dish after half of time.
(frozen spears)	O-oz. package	High (10)	6 to 8 min.	In 1-qt. casserole.
<b>Beans</b>				
(fresh green)	1 lb. cut in half	High (10)	13 to 17 min.	In 1 1/2-qt. casserole, place 1/2 cup water.
(frozen green)	O-oz. package	High (10)	7 to 9 min.	In 1-qt. casserole, place 2 tablespoons water.
(frozen lima)	(-)oz. package	High (10)	7 to 9 min.	In 1-qt. casserole, place 1/4 cup water.
<b>Beets</b>				
(fresh, whole)	1 bunch	High (10)	20 to 25 min.	In 2-qt. casserole, place 1/2 cup water.
<b>Broccoli</b>				
(fresh cut)	1 bunch (1X to 1 1/2 lbs.)	High (10)	8 to 10 min.	In 2-qt. casserole, place 1/2 cup water.
(fresh spears)	1 bunch (1 1/4 to 1 1/2 lbs.)	High (10)	10 to 13 min.	In 2-qt. oblong glass baking dish, place 1/4 cup water. Rotate dish after half of time.
(frozen, chopped)	10-oz. package	High (10)	6 to 8 min.	In 1-qt. casserole.
(frozen spears)	10-oz. package	High (10)	6 to 8 min.	In 1-qt. casserole, place 3 tablespoons water.
<b>Cabbage</b>				
(fresh)	1 medium head (about 2 lbs.)	High (10)	9 to 11 min.	In 1X-or 2-qt. casserole, place 1/4 cup water.
(wedges)		High (10)	8 to 10 min.	In 2- or 3-qt. casserole, place 1/4 cup water.
<b>Carrots</b>				
(fresh, sliced)	1 lb.	High (10)	7 to 9 min.	In 1 1/2-qt. casserole, place 1/4 cup water.
(frozen)	10-OZ. package	High (10)	6 to 8 min.	In 1-qt. casserole, place 2 tablespoons water.
<b>Cauliflower</b>				
(flowerets)	1 medium head	High (10)	10 to 14 min.	In 2-qt. casserole, place 1/2 cup water.
(fresh, whole)	1 medium head	High (10)	10 to 17 min.	In 2-qt. casserole, place 1/2 cup water.
(frozen)	10-oz. package	High (10)	6 to 8 min.	In 1-qt. casserole, place 2 tablespoons water.
<b>Corn</b>				
(frozen kernel)	10-oz. package	High (10)	5 to 8 min.	In 1-qt. casserole, place 2 tablespoons water.
<b>Corn on the cob</b>				
(fresh)	1 to 5 ears	High (10)	4 to 5 min. per ear	In 2-qt. oblong glass baking dish, place corn. If corn is in husk, use no water; if corn has been husked, add 1/4 cup water. Rearrange after half of time.
(frozen)	1 ear 2 to 6 ears	High (10) High (10)	6 to 7 min. 3 to 4 min. per ear	Place in 2-qt. oblong glass baking dish. Cover with vented plastic wrap. Rearrange after half of time.
<b>Mixed vegetables</b>				
(frozen)	10-oz. package	High (10)	5 to 8 min.	In 1-qt. casserole, place 3 tablespoons water.
<b>Peas</b>				
(fresh, shelled)	2 lbs. unshelled	High (10)	10 to 12 min.	In 1-qt. casserole, place 1/4 cup water.
(frozen)	10-OZ. package	High (10)	5 to 8 min.	In 1-qt. casserole, place 2 tablespoons water.
<b>Potatoes</b>				
(fresh, cubed, white)	4 potatoes (6 to 8 oz. each)	High (10)	12 to 14 min.	Peel and cut into 1 in. cubes. Place in 2-qt. casserole with 1/2 cup water. Stir after half of time.
(fresh, whole, sweet or white)	1 (6 to 8 oz. each)	High (10)	3 to 5 min.	Pierce with cooking fork. Place on paper towel on floor of microwave oven, 1 inch apart in circular arrangement. Let stand 5 minutes.
<b>Spinach</b>				
(fresh)	10 to 16 OZ.	High (10)	6 to 8 min.	In 2-qt. casserole, place washed spinach.
(frozen, chopped and leaf)	10-oz. package	High (10)	6 to 8 min.	In 1-qt. casserole, place 3 tablespoons water.
<b>Squash</b>				
(fresh, summer and yellow)	1 lb. sliced	High (10)	5 to 7 min.	In 1 1/2-qt. casserole, place 1/4 cup water.
(winter, acorn or butternut)	1 to 2 squash (about 1 lb. each)	High (10)	8 to 11 min.	Cut in half and remove fibrous membranes. In 2-qt. oblong glass baking dish, place squash cut-side-down. Turn cut-side-up after 4 minutes.

# CARE AND CLEANING



**Keep your oven clean and sweet-smelling.** Opening the oven door a few minutes after cooking helps air out the inside. An occasional thorough wiping with a solution of baking soda and water keeps the inside fresh.

**Don't use sharp-edged utensils on your oven.** The inside and outside oven walls can be scratched. The control panel can be damaged. **BE CERTAIN POWER IS OFF BEFORE CLEANING ANY PART OF THIS OVEN.**

## How to Clean the Inside

**Walls and floor.** Some spatters can be removed with a paper towel, others may require a damp cloth. Remove greasy spatters with a sudsy cloth, then rinse with a damp cloth. Do not use abrasive cleaners on oven walls. **NEVER USE A COMMERCIAL OVEN CLEANER ON ANY PART OF YOUR MICROWAVE OVEN.**

**Door (inside).** Window: Wipe up spatters daily and wash when soiled with a damp cloth. Rinse thoroughly and dry.

Metal and plastic parts on door: Wipe frequently with a damp cloth to remove all soil. **DO NOT USE ABRASIVES, SUCH AS CLEANING POWDERS OR STEEL AND PLASTIC PADS. THEY WILL MAR THE SURFACE.**

**Special note when using Brown 'N Sear Dish:** If grease is present, high heat generated on bottom of a Brown 'N Sear dish—may cause the grease to burn onto the oven tray. This may be removed with a cleanser such as Bon Ami<sup>®</sup> brand cleanser.

After using Bon Ami<sup>®</sup> brand cleanser, rinse and dry thoroughly, following instructions on can. Do not use Bon Ami<sup>®</sup> brand cleanser on the painted surfaces such as the walls. It may scratch the paint.

## How to Clean the Outside

**Case.** Clean the outside of your oven with soap and damp cloth, rinse with a damp cloth and then dry. Wipe the window clean with a damp cloth. Chrome trim is best wiped with a damp cloth and then with a dry towel.

**Control Panel.** Wipe with a damp cloth. Dry thoroughly. Do not use cleaning sprays, large amounts of soap and water, abrasives or sharp objects on the panel—they can damage it.

**Door Surface.** When cleaning surfaces of door and oven that come together on closing the door, use only mild, non-abrasive soaps or detergents applied with a sponge or soft cloth.

**Power Cord.** If the cord becomes soiled, unplug and wash with a damp cloth. For stubborn spots, sudsy water may be used, but be certain to rinse with a damp cloth and dry thoroughly before plugging cord into outlet.

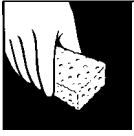

# THE EXHAUST FEATURE

The **exhaust hood** feature on your microwave oven is equipped with two metal filters which collect grease. When the fan is operated, air is drawn up through the filters. Depending on your model, it is either discharged through the provided venting to the outside or drawn through a charcoal filter and recirculated.

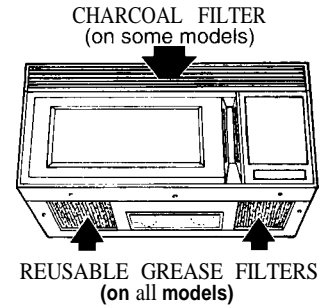

## Reusable Grease Filters (on all models)

The **grease filters should be cleaned at least once a month.** Never operate your hood without the filters in place. In situations where flaming might occur on surfaces below hood, filter will stop the entry of flames into the unit.

### To Remove Grease Filter

To remove grease filter, grasp the “finger hold” on the filter and slide to the rear. Then pull filter downward and to the front. The filter will drop out.

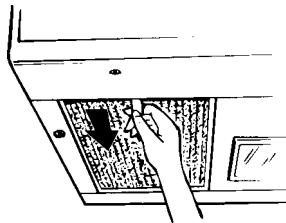

### To Clean and Replace Grease Filter

To clean grease filter, soak it and then agitate filter in solution of hot water and detergent. Don't use ammonia or ammonia products because they will darken the metal. Light brushing can be used to remove embedded dirt.

Rinse, shake and remove moisture before replacing.

To replace grease filter, slide the filter in the frame slot on the back of the opening.

Pull filter upward and to the front to lock into place.

## Charcoal Filter (on some models)

Some models are not vented to the outdoors; they recirculate the air instead. These models are equipped with a disposable charcoal filter that helps remove smoke and odors caused by cooking on your range.

The **disposable charcoal filter should be replaced when it is noticeably dirty or discolored** (usually

after 6 to 12 months, depending on hood usage). Order Part No. WB02X9883 from your GE supplier. **DO NOT CLEAN THIS FILTER. DO NOT OPERATE YOUR HOOD WITHOUT ALL THREE FILTERS IN PLACE.**

### To Remove Charcoal Filter

To remove the charcoal filter, disconnect power at main fuse or circuit breaker panel or pull plug. Remove the top grille by taking off 2 screws which hold it in place. Grasp filter and slide toward front of oven. It will slide right out.

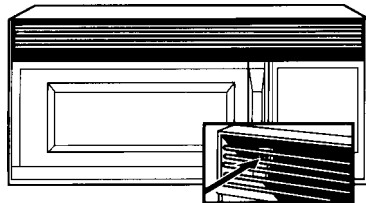

### To Install Charcoal Filter

To install a new filter, remove plastic and other outer wrapping from the new filter. Insert filter into top opening of oven as shown.

It will rest at an angle on two side support tabs and in front of right rear tab. Replace grill and secure with 2 screws.

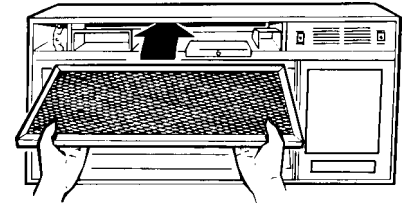

# LIGHT BULB REPLACEMENT

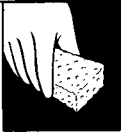

## Cooktop Light/Night Light

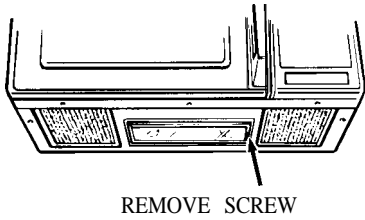

REMOVE SCREW

To replace combination cooktop light/night light, first disconnect power at main fuse or circuit breaker panel or pull plug.

Remove screw on right side of light compartment cover and lower cover until it stops.

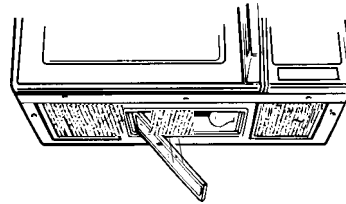

Be sure bulbs to be replaced are cool before removing. Break the adhesive seal by gently unscrewing the bulbs. Replace

with 40-watt incandescent bulbs (WB02X4253) available from your GE supplier. High intensity 40-watt bulbs (40S 11 N/1), which are available in supermarkets and hardware stores, may also be used for replacements. Raise light compartment cover and replace screw. Connect electrical power to microwave oven.

## Oven Light

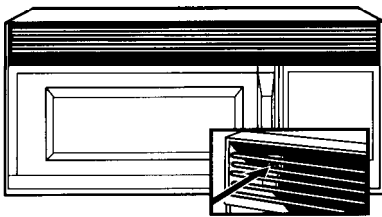

To replace your oven light, first disconnect power at main fuse or circuit breaker panel or pull plug. Remove the top grill by taking out the 2 screws that hold it in place.

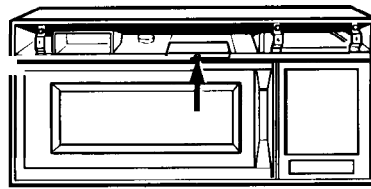

Next, remove the single screw located above door near center of oven that secures light housing. Replace burned-out bulb with a 30-watt incandescent bulb (WB02X4235), available from your GE supplier.

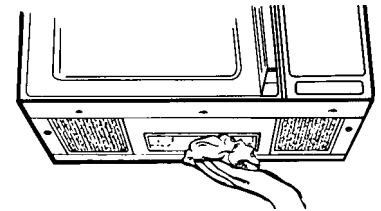

**Clean** off the grease and dust on hood surfaces often. Use a solution of warm water and detergent. About 1 tablespoon of ammonia may be added to the water. Take care not to touch the filters and enamel surfaces with this solution; ammonia will darken metal.

# GROUNDING INSTRUCTIONS

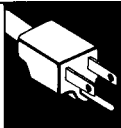

This appliance must be grounded. In the event of an electrical short circuit, grounding reduces the risk of electric shock by providing an escape wire for the electric current. This appliance is equipped with a power cord having a grounding wire with a grounding plug. The plug must be plugged into an outlet that is properly installed and grounded. (Fig.1)

**WARNING-improper** use of the grounding plug can result in a risk of electric shock.

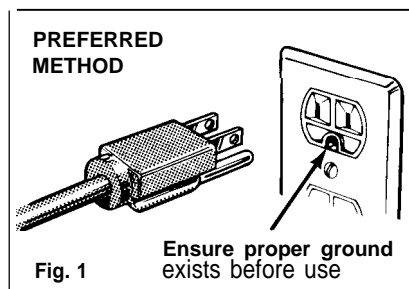

Consult a qualified electrician or service technician if the grounding instructions are not completely understood, or if doubt exists as to whether the appliance is properly grounded.

Where a standard two-prong wall receptacle is encountered, it is your personal responsibility and obligation to have it replaced with a properly grounded three-prong wall receptacle.

**Do not under any circumstance cut or remove the third (ground) prong from the power cord.**

**Do not use an adapter plug with this appliance.**

**Do not use an extension cord with this appliance.**



## QUESTIONS? USE THIS PROBLEM SOLVER

PROBLEM	POSSIBLE CAUSE
OVEN WILL NOT COME ON	<ul style="list-style-type: none"> <li>• A fuse in your home may be blown or the circuit breaker tripped. Replace fuse or reset circuit breaker.</li> <li>• Unplug your microwave oven, then plug it back in.</li> <li>• Make sure 3-prong plug on oven is fully inserted into wall receptacle.</li> </ul>
CONTROL PANEL LIGHTED, YET OVEN WILL NOT START	<ul style="list-style-type: none"> <li>• Door not securely closed.</li> <li>• START pad must be touched after entering cooking selection.</li> <li>• Another selection entered already in oven and CLEAR/OFF pad not touched to cancel it.</li> <li>• Make sure you have entered cooking time after touching TIME COOK I &amp; II pad.</li> <li>• CLEAR/OFF pad was touched accidentally. Reset cooking program and touch START pad.</li> </ul>
FOODS ARE EITHER OVERCOOKED OR UNDERCOOKED	<ul style="list-style-type: none"> <li>• Cooking times may vary because of starting food temperature, food density or amount of foods in oven. Touch TIME COOK I &amp; II pad and additional cooking time for completion.</li> <li>• Incorrect power level entered. Check Cooking Guide for recommended power level.</li> <li>• Dish was not rotated, turned or stirred. Some dishes require specific instructions. Check Cooking Guide or recipe for instructions.</li> <li>• Too many dishes in oven at same time. Cooking time must be increased when cooking more than one food item. Check Cooking Guide time recommendations.</li> </ul>
FLOOR OF THE OVEN IS WARM, EVEN WHEN THE OVEN HAS NOT BEEN USED	<ul style="list-style-type: none"> <li>• The cooktop lamp is located directly below the oven floor. When the lamp is on, the heat it produces makes the oven floor get warm. This is normal.</li> </ul>

**All these things are normal with your microwave oven:**

- |  |  |  |
|--|--|--|
| <ul style="list-style-type: none"> <li>• Steam or vapor escaping from around the door.</li> <li>• Light reflection around door or outer case.</li> </ul> | <ul style="list-style-type: none"> <li>• Dimming oven light and change in blower sound may occur while operating at power levels other than high.</li> <li>• Dull thumping sound while oven is operating.</li> </ul> | <ul style="list-style-type: none"> <li>• Some TV-Radio interference might be noticed while using your microwave oven. It's similar to the interference caused by other small appliances and does not indicate a problem with your oven.</li> </ul> |
|--|--|--|

---

**If you need more help...call, toll free: GE Answer Center™/ 800.626.2000/ consumer information service**

---



# NOTES

---

# NOTES

# We'll Be There

With the purchase of your new GE appliance, receive the assurance that if you ever need information or assistance from GE, we'll be there. All you have to do is call-toll-free!

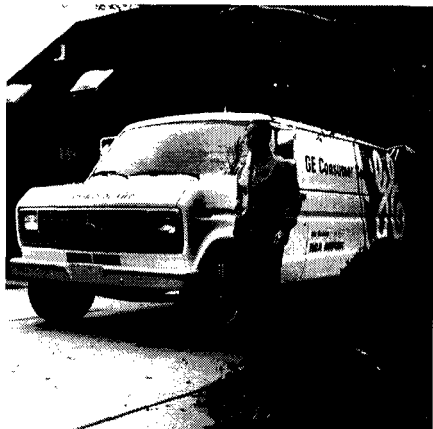

## In-Home Repair Service

**800-GE-CARES**  
**(800-432-2737)**

A GE consumer service professional will provide expert repair service, scheduled at a time that's convenient for you. Many GE Consumer Service company-operated locations offer you service today or tomorrow, or at your convenience (7:00 a.m. to 7:00 p.m. weekdays, 9:00 a.m. to 2:00 p.m. Saturdays). Our factory-trained technicians know your appliance inside and out—so most repairs can be handled in just one visit.



## Service Contracts

**800-626-2224**

You can have the secure feeling that GE Consumer Service will still be there after your warranty expires. Purchase a GE contract while your warranty is still in effect and you'll receive a substantial discount. With a multiple-year contract, you're assured of future service at today's prices.

## Parts and Accessories

**800-626-2002**

Individuals qualified to service their own appliances can have needed parts or accessories sent directly to their home. The GE parts system provides access to over 47,000 parts...and all GE Genuine Renewal Parts are fully warranted. VISA, MasterCard and Discover cards are accepted.

User maintenance instructions contained in this booklet cover procedures intended to be performed by any user. Other servicing generally should be referred to qualified service personnel. Caution must be exercised, since improper servicing may cause unsafe operation.



## GE Answer Center®

**8086262000**

Whatever your question about any (major appliance, GE Answer Center information service is available to help. Your call—and your question—will be answered promptly and courteously. And you can call any time. GE Answer Center® service is open 24 hours a day, 7 days a week.

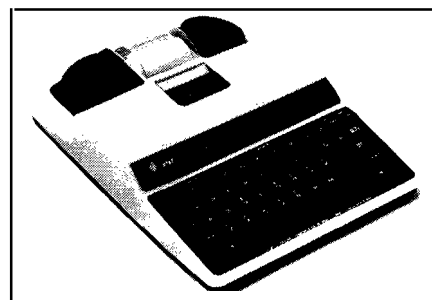

Telecommunication Device for the Deaf

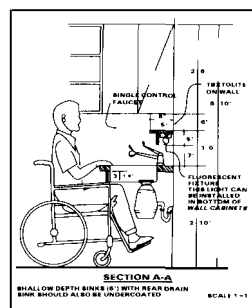

## For Customers With Special Needs...

**800.626.2000**

Upon request, GE will provide Braille controls for a variety of GE appliances and a brochure to assist in planning a barrier-free kitchen for persons with limited mobility. To obtain these items free of charge, call 800.626.2000.

Consumers with impaired hearing or speech who have access to a TDD or a conventional teletypewriter may call 800-TDD-GEAC (800-8334322) to request information or service.

# YOUR GE MICROWAVE OVEN WARRANTY

Save proof of original purchase date such as your sales slip or cancelled check to establish warranty period.

## WHAT IS COVERED

### FULL ONE-YEAR WARRANTY

For one year from date of original purchase, we will provide, free of charge, parts and service labor in your home to repair or replace **any part of the microwave oven** that fails because of a manufacturing defect.

### LIMITED ADDITIONAL NINE-YEAR WARRANTY

For the second through tenth year from date of original purchase, we will provide, free of charge, a replacement **magnetron tube** if the magnetron tube fails because of a manufacturing defect. You pay for the service trip to your home and service labor charges.

This warranty is extended to the original purchaser and any succeeding owner for products purchased for ordinary home use in the 48 mainland states, Hawaii and Washington, D.C. In Alaska the warranty is the same except that it is LIMITED because you must pay to ship the product to the service shop or for the service technician's travel costs to your home.

All warranty service will be provided by our Factory Service Centers or by our authorized Customer Care" servicers during normal working hours.

Call 1-800-GE CARES (1-800-432-2737).

## WHAT IS NOT COVERED

- Service trips to your home to teach you how to use the product.

### Read your Use and Care material.

If you then have any questions about operating the product, please contact your dealer or our Consumer Affairs office at the address below, or call, toll free:

GE Answer Center"  
800.626.2000  
consumer information service

- Improper installation.

If you have an installation problem, contact your dealer or installer. You are responsible for providing adequate electrical, gas, exhausting and other connecting facilities.

- Replacement of house fuses or resetting of circuit breakers.
- Failure of the product if it is used for other than its intended purpose or used commercially.

- Damage to product caused by accident, fire, floods or acts of God.

WARRANTOR IS NOT RESPONSIBLE FOR CONSEQUENTIAL DAMAGES.

Some states do not allow the exclusion or limitation of incidental or consequential damages, so the above limitation or exclusion may not apply to you. This warranty gives you specific legal rights, and you may also have other rights which vary from state to state. To know what your legal rights are in your state, consult your local or state consumer affairs office or your state's Attorney General.

**Warrantor: General Electric Company**

**If further help is needed concerning this warranty, write:  
Manager—Consumer Affairs, GE Appliances, Louisville, KY 40225**

Part No. 164 D2588P088  
Pub. No. 49-8284

JVM132K  
JVM133K