

# MICROMAT 745/745E

## Microwave oven

Operating instructions



---

## Before you operate the oven

- Please read the instructions and guarantee information and keep for future reference.
- Please complete the guarantee card and send to our Service Department.
- Make sure that the appliance is not damaged. Check that the oven door closes firmly against the door support and that the internal door seal is not damaged.
- Place the oven on a stable, even surface, at a distance from other heating sources. The cooling air, which is taken in by the ventilation grids at the sides of the oven, must not exceed 35°C temperature. For sufficient ventilation there must be a space of at least 20 mm between the nearest wall and the ventilation grids on the sides of the oven and a space of at least 30 mm above the oven.
- A kit is available to enable this oven to be built-in, see last page. The kit, type number EBR 32, can be purchased via your dealer.
- The oven can be operated only if the oven door is firmly closed.
- Poor television reception and radio interference may result if the oven is located close to a TV, radio or aerial.

### Warning:

The appliance should not be operated without food in the oven, operation in this manner is likely to damage the appliance.

---

## Electrical connection

Check that the voltage on the rating plate corresponds to the voltage in your home. The rating plate is on the back panel of the appliance.

### **“Warning – this appliance must be earthed”**

The earthing of this appliance is compulsory by law. The manufacturer will accept no responsibility for damage to persons or objects arising from the non-observance of this requirement.

A suitable plug should be fitted to the mains cable. If a 13 Amp plug is to be fitted, then a 13 Amp fuse should be used in the plug.

**Important:** The wires of the mains lead fitted to this appliance are coloured in accordance with the following code:

GREEN AND YELLOW	– EARTH
BLUE	– NEUTRAL
BROWN	– LIVE

As the colours of the wires in the mains lead fitted to this appliance may not correspond with the coloured markings identifying the terminals in the plug, proceed as follows:

The wire which is coloured GREEN AND YELLOW must be connected to the terminal in the plug which is marked with the letter “E” or by the earth symbol  $\perp$  or coloured GREEN or GREEN AND YELLOW.

The wire which is coloured BLUE must be connected to the terminal which is marked with the letter “N” or coloured BLACK. The wire which is coloured BROWN must be connected to the terminal which is marked with the letter “L” or coloured RED. If the terminals in the plug are unmarked or you are in any doubt as to the correct connections, consult a qualified electrician.

**N.B.** We recommend the use of a good quality plug.

### **For the Republic of Ireland only**

The information given in respect of Great Britain will frequently apply, but a third type of plug and socket is also used, the 2-pin, side earth type. In this case, the wire which is coloured GREEN AND YELLOW MUST BE CONNECTED TO THE EARTH contact and the other two wires to the pins, irrespective of colour. The supply to the socket must be fitted with a 16 Amp fuse.

---

## Microwaves – what are they?

Microwaves are a kind of electromagnetic energy. Ordinary daylight and radiowaves are two other examples. The wavelength is the only difference between these three types of energy.

Microwaves are absorbed by water and oil. All foods contain water or fat and act as receivers for the microwave energy. The water molecules are excited by the microwaves which produces heat, thus the water is heated.

Just as ordinary daylight passes through glass, clear plastic and air, the microwaves have the ability to go through materials like paper, glass, porcelain, plastic and air. These materials will consequently not be heated up by the microwaves.

The microwaves are reflected by metal in the same way as light is reflected by a mirror.

---

### Important

- Do not use your microwave oven for cooking or reheating whole eggs with or without shell.
- Do not use your microwave oven for deepfrying, because you cannot control the oil temperature.
- Do not use your microwave oven for heating liquids in airtight sealed containers. The pressure increases and may cause damage when opening or may explode.
- Do not use your microwave oven for drying textiles, paper, or other combustible materials.
- When cooking, or re-heating liquids (water) in microwave ovens it is possible that the boiling point is reached without any bubbles being visible. The liquid does not cook regularly, this can lead to, when taking out the vessel (for example, cups or mugs), liquid boiling over and there is a risk of scalding oneself. To avoid this, put a teaspoon in the cup or mug before starting the cooking process. In this case, there is no risk of damage from the metal to the microwave oven.
- One of the major advantages of microwave ovens is the short cooking time. Therefore, do not exceed recommended times for cooking and for re-heating food.
- Always refer to a microwave cookbook for details. Especially, if cooking or reheating food that contains alcohol.
- If material inside the oven should ignite, keep oven door closed, turn the oven off and remove the plug from the supply socket. To reduce the risk of fire in the oven cavity:
- Do not overcook food. Always add the alcohol **after** cooking (if required!).
- Do not leave the oven unattended, especially not when using paper, plastic or other combustible materials in the cooking process.
- Remove wire twist-ties from paper or plastic bags before placing bag in oven.
- Make sure the utensils you use in your microwave oven are suitable for microwave cooking.

---

## Which utensils can be used in the oven?

Utensils made of **china** and **ceramic** are excellent to use in your microwave oven. Most types of **glass** are also very good. Lead crystal glass can crack and should therefore, not be used.

**Plastics** and **paper** can also be used, provided they can withstand the temperature of the heated food.

For cooking only use plastics, which will withstand a temperature of over 120°C, e.g. **polypropene** ↓ **polyamide**.

**Some plastic materials, e.g. melamine, will be heated by the microwaves, and be damaged.**

To find out if a certain container is suitable, the following simple test can be made: Place the empty container and a glass of water inside the microwave oven. The water is needed because the oven must not be operated empty or with empty containers. Let the oven work on full power for one minute. A suitable container will only be lukewarm.

Metal containers, e.g. saucepans or frying pans should not be used in microwave ovens. Nor should plates or vessels with decorations be used since metal e.g. gold, might be part of the decoration and such decorations will be damaged.

Small pieces of aluminum foil can be used, but only to shield the areas that would overcook (e.g. for covering chicken wings leg tips and fish tails) but the foil must not touch the side of the oven as damage may occur.

For browning in the microwave oven, you need a special browning dish, which is available from your dealer as an accessory.

**Caution:**

- There are a number of accessories available on the market. Before you buy, make sure they are suitable for microwave use.
- When you put food in the microwave oven, make sure that food, food supports or covering do not come in direct contact with any of the internal walls or the plastic cover in the ceiling of the cavity since discolouration may take place.

**Cooking, reheating and defrosting with microwaves**

In a microwave oven the water molecules of the food are put into motion by the microwave energy directly. The increased movement is the same as heat. Microwaves penetrate the food and heat up not only on the surface. Heating and cooking by microwaves is very fast and energy saving since the food container does not need to be heated up. The container for the food gets warmed up only indirectly by heat transfer from the heated food to the container and this prevents the food from sticking to the pan. As a consequence very little fat needs to be added during the cooking process. Retention of taste and nutritional qualities of the food are improved by microwave cooking since cooking times are shorter and smaller amounts of liquid are added.

Cooking in a microwave oven has many similarities with conventional cooking – but the cooking process is different and faster. Since the cooking process is faster, compared to conventional cooking, you should always consult your microwave cookbook before you start preparing a certain dish.

For normal recipe cooking, like cooking trout, always follow the recipe in your cookbook.

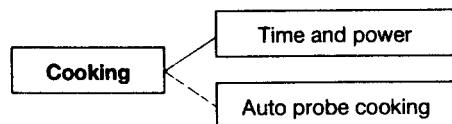

Cooking can be done either in the Time and Power Mode or in the Autoprobe Cooking Mode.

**Time and power cooking:**

Cooking by time and power goes very fast and can be used for a variety of food such as: vegetables, meat fish, poultry and soups.

**Auto probe cooking**

This method gives you very good control of the end temperature when cooking such food as roastbeef or big trout.

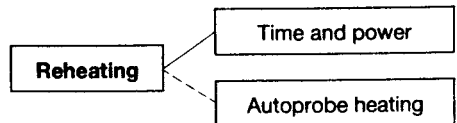

Reheating of already cooked food is a major application area for your microwave oven. Reheating is very fast and is from a nutritional point of view better than any other kind of reheating method. The food can be reheated directly on the plate (see setting on which utensils can be used in your microwave). Reheating of a portion on a plate for a late guest is accomplished in one to two minutes.

Heating or reheating can be done with your microwave oven in two different modes.

**Time and power heating**

By choosing the proper time and power level you can heat up the food to any desired temperature, up to cooking temperature.

### Auto Probe heating:

This method gives you the most accurate end temperature and should preferably be used when heating up baby food or fresh yeast liquid. Any temperature between 35°C and 95°C can be set. Heating up a cup of chocolate to a perfect drinking temperature is accomplished very quickly.

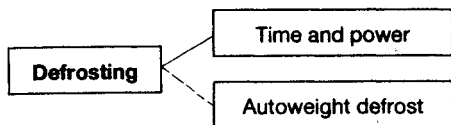

Your microwave oven will be of assistance when defrosting deep frozen food, precooked, as well as raw food.

### Time and power defrosting

Defrosting can be accomplished in the time and power mode. If you use this mode, please note the following:

- Defrosting is best completed on low to average power. By using too high power parts of the food can get too hot, while other parts still can be frozen.
- Use the power level indicated with the defrost symbol.

### Autoweight defrosting

Your microwave oven has a special automatic defrosting function, which provides you with good end results. The oven needs to know the type of food to be defrosted and the net weight of the food. Seven food classes have been designed into your oven and they cover the whole spectrum of European food.

---

## General guidelines

Since microwave cooking to some extent is different from traditional cooking, the following general guidelines should be considered whenever you use your microwave oven:

### How to select power level?

For maximum flexibility in the cooking process, your oven has been designed with eight power levels:

- |   |  |
|---|--|
| Level 100%  | = Full power. To be used for cooking and heating of vegetables, fish, meat etc., where the microwave cookbook recommends full power or a high power level.                               |
| Level 70–80%  | = 3/4 of full power. To be used when more careful cooking is required, e.g. high protein sauces, cheese- and eggdishes and to finish cooking casseroles. Can also be used for reheating. |
| Level 40–60%  | = medium power. To be used when simmering e.g. stews and for reheating of pastry.  |
| Level  | = defrost. To be used especially for raw ingredients. You can also choose level 15%.   |
| Level 15%   | = low power. Can be used for defrosting but also for softening butter, cheese and icecream.  |

### If the food is undercooked

Check if:

- you have pressed the start button again after having opened the door to check the food.
- you have selected the correct power level.
- the selected time is sufficient – the times given in the recipes are approximate. They depend on initial temperature, weight and density of the food etc.
- the container is appropriate.

### If the food is overcooked, i.e. dried out or burnt

Before you cook again, consider whether:

- the power level was too high
- the set time was too long – the times in the recipes are approximate. They depend on initial temperature, weight and density of the food etc.

### The amount of food

The more food you want to prepare the longer it takes. A rule of thumb is that double amount of food requires almost double the time. If one potato takes four minutes to cook, approximately seven minutes are required to cook two potatoes.

### Starting temperature of food

The lower the temperature of the food which is being put into the microwave oven, the longer time it takes. Food at room temperature will be reheated more quickly than food at refrigerator temperature.

### Composition of the food

Food with a lot of fat and sugar will be heated faster than food containing a lot of water. Fat and sugar will also reach higher temperature than water in the cooking process.

The more dense the food, the longer it takes to heat. "Very dense" food like meat takes longer time to reheat than lighter, more porous food like sponge cakes.

### Covering food helps:

- To reduce spattering
- To shorten cooking times
- To retain food moisture

All coverings, which will allow microwaves to pass through are suitable – See above "Which utensils can be used in the oven".

### Standing time

Always allow the food to stand for some time after using the oven (either inside or outside the oven). Standing time after defrosting/reheating cooking, always improves the result since the temperature of the food will then be more even.

### Arranging food

The best result is achieved if the food is evenly distributed on the plate.

- A food portion should be arranged with the thicker, denser foods to the outside of the plate and the thinner or less dense foods in the middle. This is very important when reheating a plate with two or more different kinds of foods.
- Gravy or sauce should be reheated in a separate container. Choose a tall, narrow container rather than a low and wide container.

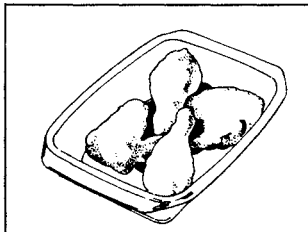

With unevenly shaped foods, the thinner parts will cook faster than the thicker areas. Place the thinner chicken wings and legs to the centre of the dish.

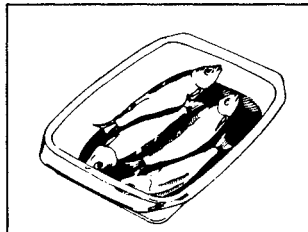

Unevenly shaped foods such as fish should be arranged in the oven with the thinner tails to the centre.

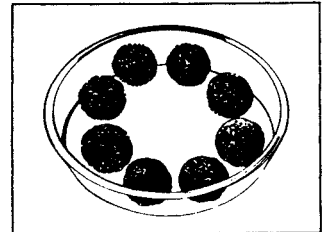

When cooking foods such as meatballs place them in a ring pattern.

When reheating gravy, sauce or soup, do not fill the container more than 2/3.

- Potatoes for reheating should not be bigger than 60–75 g. Cut bigger potatoes in half and place them with the cut side down.
- If you are reheating several items of the same food, place them in a ring pattern.
- When defrosting or reheating/cooking more than one plate at the same time, the amount and arrangement of food must be identical in order to achieve the same temperature.
- Place **thin** slices of meat on top of each other or interlace them.
- Thicker slices such as meat loaf and sausages have to be placed close to each other.
- When you reheat whole fish, score the skin – this prevents cracking. Shield the tail and head with small pieces of foil to prevent overcooking but ensure the foil does not touch the sides of the oven.
- To avoid overcooking of salient parts or edges e.g. mashed potatoes, place on the plate with the help of a spoon to obtain a nice rounded shape.
- Food with skin or peel, such as potatoes, tomatoes, sausages and the like, should be pricked with a fork so that the steam can escape and the skin or peel does not burst.
- After heating babyfood, **always** stir it to make sure that the heat is evenly distributed.

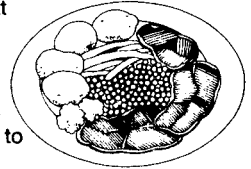

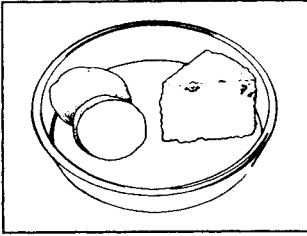

The denser the food, the longer it takes to cook. Although about the same size, the denser potato will take much longer to cook than the lightertextured sponge cake.

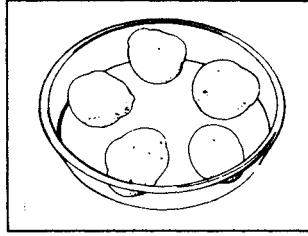

If you are cooking several items of the same food such as jacket potatoes, place them in a ring pattern for uniform cooking.

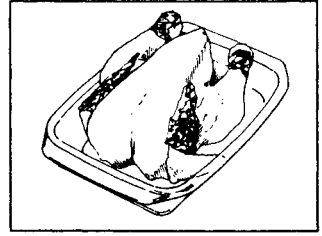

Small amounts of foil are permissible and recommended for covering thinner parts of food such as chicken wings and legs.

## Control panel and symbol description

- ① Digital display
- ② Stage indicator lamps
- ② Cook lamp
- ③ Clock button
- ④ Memory program button
- ⑤ Time buttons
- ⑥ Power level button
- ⑦ Defrost button
- ⑧ Memory buttons
- ⑩ Stage buttons
- ⑪ Cancel for reset button
- ⑫ Start button
- ⌚ Clock symbol
- 🕒 Cooking time symbol
- % Power symbol
- ⊘ Cancel symbol
- ⚡ Defrost symbol
- ◇ Start symbol
- °C Set temperature symbol
- 🍲 Food temperature symbol
- 📏 Weight symbol
- 👤 Cooking symbol



### Bread

- Buns
- Rolls
- Bread loaf
- Biscuits



### Soft fruit

- Strawberries
- Raspberries
- Blackberries



### Vegetables

- Broccoli
- Cauliflower
- Mixed vegetables



### Poultry

- Chicken, whole or in pieces
- Turkey



### Shellfish

- Shrimps
- Crab
- Lobster



### Meat

- Pork chops
- Steaks
- Leg of lamb
- Minced meat



### Fish

- Codsteaks
- Plaice fillets
- Trouts



## Setting the clock



1. Press the clock button the two left hand figures flicker.



2. Press the time button. Note that the display is in 24 hours mode – stop when the correct hour has been reached. The left button counts down. The right button counts up.



3. Press the clock button again and the two right hand figures flicker.

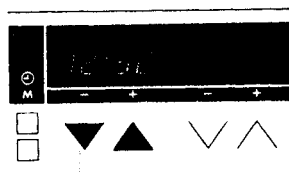

4. Press the time button. Stop when the correct minutes are reached. The left button counts down. The right button counts up.

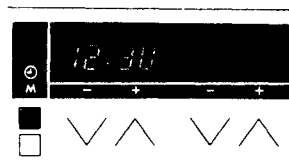

5. Press the clock button again and the clock operates.

**Note:** The above sequence must be accomplished within 30 seconds otherwise you will have to start again.

**NOTE:** This oven is equipped with an electronic touch control system, which has a beep signal when pressing the buttons. To cancel this beep; just press the cancel button for 5 seconds. To re-install the beep; just press the cancel button for 5 seconds.

## Cooking by time and power

*Never operate the oven empty!*

1. Place food to be cooked in the oven and close the door.



2. Press the time button until the required cook time is indicated. The oven is automatically set on full power.

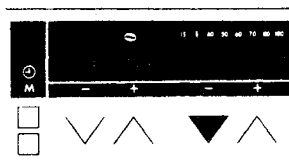

3. Press the power level button if you require a power other than full power. The left button counts down.

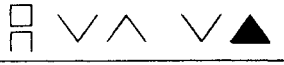

The right button counts up.

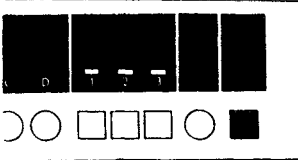

- Press the start button. The cook lamp lights up and the cavity lamp, fan etc. operate and the cooking process begins.

- When the cooking time has elapsed an acoustic signal sounds and the oven switches off.

**To interrupt the cooking process:**

If you wish to check, stir or turn the food just open the door and the cooking process automatically stops.

**To restart the cooking process:**

Close the door and press the start button again.

**If you do not wish to continue cooking**

Close the door. The fan stops and the cavity lamp is switched off automatically after 30 seconds or press the cancel button.

If the oven door is left open the oven switches off automatically after 10 minutes.

## Temperature cooking

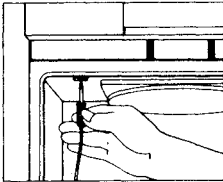

- Insert the probe in the socket in the ceiling of the cavity.

The display now displays degrees centigrade.



- Insert the probe in the food.
- Close the door.

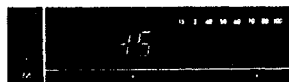

- Press the time button until the required finishing temperature is indicated on the two right numbers. Temperature range 35–95°C.

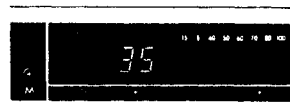

- Press the power level button if you require a power other than the full power.

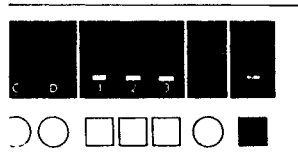

- Press the start button. The cooking process begins.

**Note:** The two left hand numbers indicate the actual temperature of the food, if it is above 35°C and is below the finishing temperature. *Both temperature and power are possible to change during cooking.*

- When the food reaches the finish temperature an acoustic signal will sound three times and then the oven automatically switches off.

## Warning

The oven must not be operated with the temperature probe in the cavity if it is not plugged into the oven. If you do operate the oven without complying with the above you will damage the probe.

## Automatic defrost

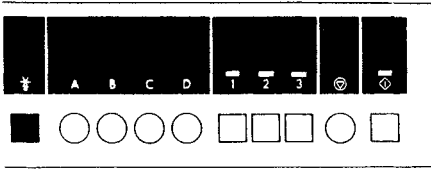

1. Press the defrost button. The digital display now shows weight in grams (gr) and the power level indicate the first of seven food categories.

**Note:** For pounds and ounces press the defrost button for 3 seconds or until the lbs. & oz symbols light up on the display.

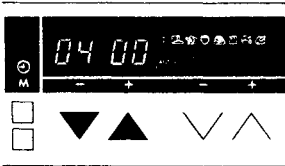

2. Press the time button to select the weight required.



3. Press the power level button to select the category of food.

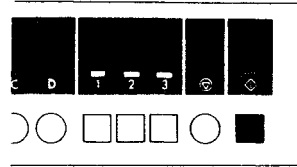

4. Press the start button. The timer indicator now displays the time required to defrost and starts to count down.

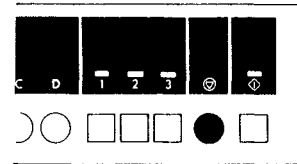

5. Press the cancel button if you wish to stop the auto defrost once it has started. Also time and power cannot be changed once started.

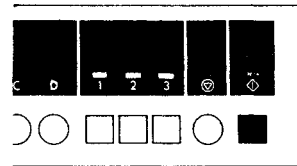

6. If the cook sequence is interrupted to inspect the food, simply press the start button to continue.

### Important

When using the automatic defrost function, the weight to be entered is the net weight, meaning only the weight of the food, the vessel excluded. Only use the automatic defrost function for raw food. The automatic defrost gives best result, if the food is at  $-18^{\circ}\text{C}$  and the food to be defrosted is taken directly from the freezer. If the food is warmer than deepfreeze temperature ( $-18^{\circ}\text{C}$ ) e.g. is stored in the freezing compartment of the refrigerator, which is not a *three* star, the defrosting time calculated by the oven will be too long and you may risk overcooking the food. Choose in that case lower weight of the food and by that shorter defrosting time.

Choose also lower weight of the food to be defrosted, if the food is stored outside the freezer for times up to 20 minutes. Defrost by time and power if the food is stored outside the freezer for more than 20 minutes and for defrosting ready-made food. See "How to cook by time and power". Standing time always improves the result. See "General guidelines". Small pieces of aluminumfoil may be used to shield e.g. chicken wings, leg tips and fishtails but the foil must not touch the side of the oven as damage may occur.

## Stage cooking

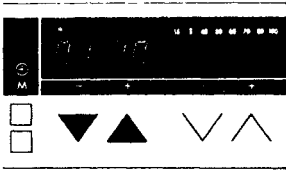

1. Press the time button to set the required cook time.

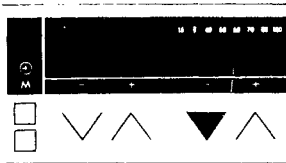

2. Press the power button to set the required power.

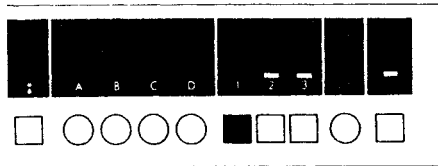

3. Press the first stage button, the first stage lamp will be illuminated indicating the power and time have been stored.

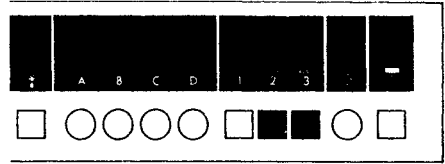

**Note:** To set the other two stages – 2 and 3 – proceed as above.

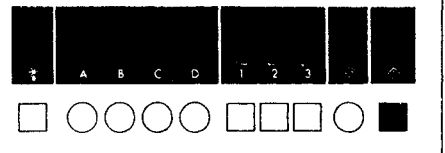

4. Press start button – the cooking process begins.

Stage cooking is always executed from left to right i.e. Stage 1, Stage 2 and then Stage 3. When one stage is finished an acoustic signal is heard and the stage indicator lamp is switched off and the oven immediately starts the next stage.

The principle is that what ever is displayed is stored in which ever stage button is pressed. The corresponding stage indicator lamp will be illuminated which shows that the time and power has been stored. If the relevant stage button is pressed again the information is moved to the display and the stage indicator lamp is switched off. Press again to re-install in the stage.

**Note:** If auto weight defrost has been entered into stage 1 then auto weight defrost cannot be entered by pressing the defrost button.

## Memories

When the appliance is plugged in or after a power failure, your oven memories will have stored the following:

Memory A – 30 seconds at full power and 37°C

Memory B – 1 minute at full power and 50°C

Memory C – 2 minutes at full power and 70°C

Memory D – 5 minutes at full power and 90°C

## To use the memorised program

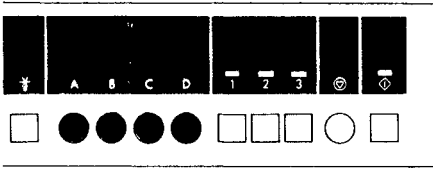

1. Press one of the memory buttons. The memory content is then shown on the digital display.

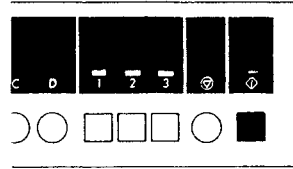

2. Press the start button. The cook indicator lamp will switch on and the oven will operate. When the memorised program has ended the oven stops automatically.

## To re-program the memories

Select what you want to store from the previous processes already described, i.e.

Time and Power

Stage Cooking

Autoweight Defrosting

Auto probe Cooking (with the probe inserted).

### EXAMPLE

Lets say we wish to cook some items for 1 minute at Power Level 50%.



1. Press the time button until 1 minute is indicated.

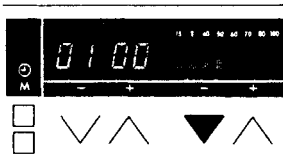

2. Press the power level button until power 50% is indicated.

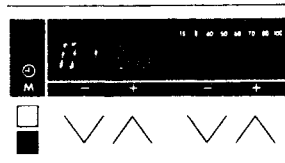

3. Press the memory programming button.

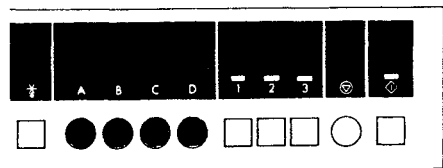

4. Press one of the memory buttons.

**Note:** When new values are stored in the memory the old memory content is erased. Entering new temperatures is only possible when the temperature probe is inserted into its socket. Entering new temperatures in the memory does not erase other stored data.

---

## Maintenance

Cleaning is the only maintenance normally required. It must be carried out with the microwave oven switched off. Use a mild detergent, water and a soft cloth to clean the interior surfaces, the front and rear of the door and the door opening.

When cooking food with a high moisture content, condensation may appear on the inner door glass or on the cavity walls. This will normally disappear after a short time when the process is finished. If present at the end of the cooking process, wipe with a cloth.

Do not use chemicals or abrasive compounds to clean any part of the microwave oven.

Do not allow grease or food particles to build up around the door. Odours inside the oven can be eliminated by placing a cup of water with lemon juice added into the oven and boiling the mixture.

**Note:** The doorseals and the doorseal areas must be regularly inspected for damage. If these areas are damaged the appliance should not be operated until it has been repaired by a service technician trained by the manufacturer. At regular intervals especially if spillages have occurred

remove the bottom plate and wipe clean the base of the oven. Replace the plate. Do not use the oven without the bottom plate.

---

## Service

If the oven does not work, do not make a service call until you have made the following checks:

- the plug is properly inserted in the wall socket
- the door is properly closed
- the cooking time has been programmed
- check your fuses and make sure that there is power available
- wait for ten minutes and then try to operate the cooker once more

This is to avoid unnecessary calls for which you will be charged. When calling for Service, please give the serial number and type number of the cooker (see rating plate on the back). Contact the nearest local branch of AEG Service.

### Warning

Service only to be carried out by a service technician trained by AEG. It is dangerous for anyone other than a service technician trained by the manufacturer to perform repair service.

---

## Guarantee

See the guarantee conditions supplied with the oven.

---

## Technical specifications

<b>Model</b>	<b>Micromat 745</b>															
Supply voltage	240 V/50 Hz															
Power consumption	1400 W															
Fuse	13 Amps															
Microwave power (acc. to IEC59H, 1000 g water)																
Power level 100%	750 W															
Power level 80%	600 W															
Power level 70%	520 W															
Power level 60%	450 W															
Power level 50%	370 W															
Power level 40%	300 W															
Power level	220 W															
Power level 15%	120 W															
Timer	Electronic 99 min.															
Time setting for cooking	One second step In steps by: 5 sec up to 30 sec 10 sec in interval 30–60 sec 15 sec in interval 1–3 min 30 sec in interval 3–6 min 1 min in interval 6–99 min															
Probe temperature range	35°–95°C															
Defrost weight table	<table border="1"> <thead> <tr> <th>INTERVAL</th> <th>STEPS</th> </tr> </thead> <tbody> <tr> <td>50– 500 g</td> <td>25 g</td> </tr> <tr> <td>500– 800 g</td> <td>50 g</td> </tr> <tr> <td>800–2000 g</td> <td>100 g</td> </tr> </tbody> </table>	INTERVAL	STEPS	50– 500 g	25 g	500– 800 g	50 g	800–2000 g	100 g							
INTERVAL	STEPS															
50– 500 g	25 g															
500– 800 g	50 g															
800–2000 g	100 g															
Weight table in UK-version is:	<p>For poultry class also:</p> <table border="1"> <tbody> <tr> <td>2000–3000 g</td> <td>250 g</td> </tr> <tr> <td>3000–5000 g</td> <td>500 g</td> </tr> </tbody> </table> <p>2 oz, 3 oz,.... 15 oz, 1 lb, 1 lb 1oz.... 1/4, 1/6, 1/8, 1/10, 1/12, 1/14, 2/0, 2/4, 2/8, 2/12, 3/0, 3/4, 3/8, 3/12, 4/0, 4/4, 4/8, 4/12, 5/0, 5/8, 6/0, 6/8, 7/0, 8/0, 9/0, 10/0, 11/0</p>	2000–3000 g	250 g	3000–5000 g	500 g											
2000–3000 g	250 g															
3000–5000 g	500 g															
For poultry-class also:																
Preset memories	<table border="1"> <thead> <tr> <th>Time</th> <th>Power level</th> <th>temp</th> </tr> </thead> <tbody> <tr> <td>30 sec.</td> <td>100%</td> <td>37°C</td> </tr> <tr> <td>1 min.</td> <td>100%</td> <td>50°C</td> </tr> <tr> <td>2 min.</td> <td>100%</td> <td>70°C</td> </tr> <tr> <td>5 min.</td> <td>100%</td> <td>90°C</td> </tr> </tbody> </table>	Time	Power level	temp	30 sec.	100%	37°C	1 min.	100%	50°C	2 min.	100%	70°C	5 min.	100%	90°C
Time	Power level	temp														
30 sec.	100%	37°C														
1 min.	100%	50°C														
2 min.	100%	70°C														
5 min.	100%	90°C														
Dimensions:																
Outer dimensions:	H×W×D 395×500×410 mm															
Oven compartment:	190×498×340 mm															
Weight:	21 kg															

This product is manufactured to comply with the radio interference requirements of the council directive 82/499/EEC.

**Data for test heating performance in accordance with IEC SC 59H.**

The International Electrotechnical Commission, SC 59H, has developed a standard for comparative testing of heating performance of different microwave ovens. We recommend the following for this oven:

Test	Approx. time	Power level	Container
A	12 min	Full (100%)	Pyrex 3.226
B	5 min	Full (100%)	Pyrex 3.827.80
C	14 min	Full (100%)	Pyrex 3.838.80
Defrosting, minced meat	9 min	Defrost	Pyrex 3.838.80 defrost on a 3 mm plastic plate

---



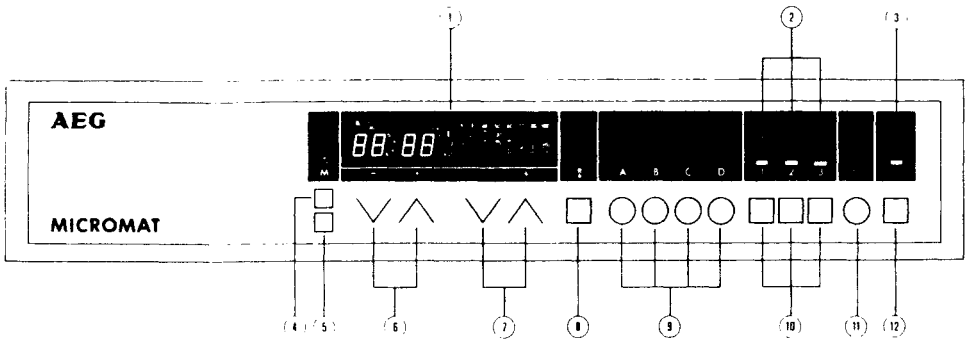
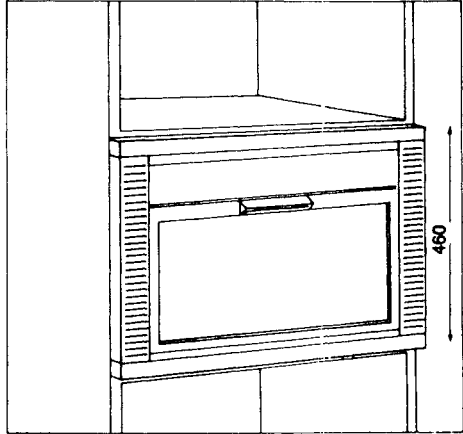
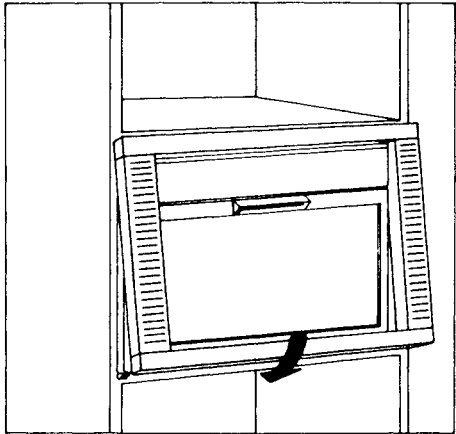
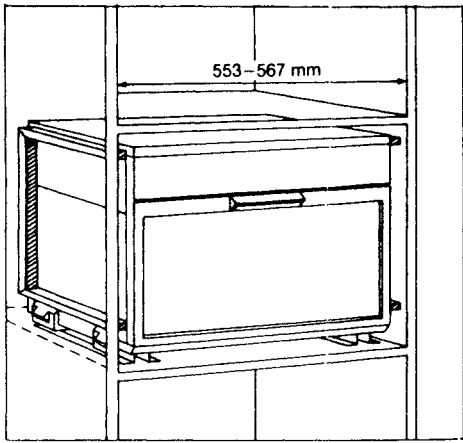
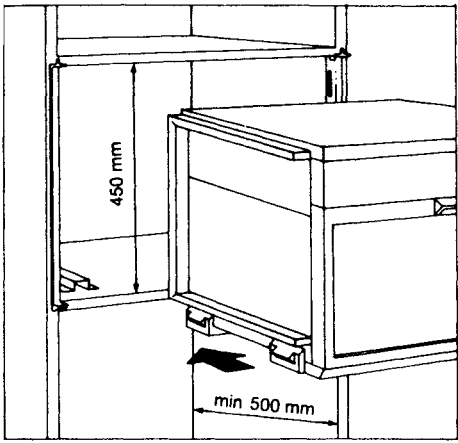

AEG Aktiengesellschaft  
Hausgeräte  
Postfach 1036  
D-8500 Nürnberg 1

© Copyright by AEG

**H 261 261 800**

Änderungen vorbehalten  
Subject to change without notice  
Sous réserve de modifications

4231 094 15521



AEG Hausgeräte GmbH  
Postfach 1036  
D-90327 Nürnberg  
© Copyright By AEG

H261 261 800

**AEG Domestic Appliances Ltd**  
Customer Care Department  
55-77 High Street  
Slough  
Berkshire SL1 1DZ  
Telephone: 08705 350350