

# MCD2660E

Microwave oven

Operating instructions



PERFEKT IN FORM UND FUNKTION

**AEG**  
Electrolux

# Dear Customer,

Thank you for buying an AEG-Electrolux microwave oven and putting your trust in the AEG-Electrolux brand name.

Before using your AEG-Electrolux microwave oven for the first time, please read the instruction book thoroughly. This will enable you to take advantage of all the features that the appliance offers. It will also ensure trouble-free operation and minimize unnecessary service calls.



Important information concerning your safety or the operation of your appliance is noted by this symbol and/or mentions words such as «**Warning**», «**Take care**». Be sure to follow all instructions carefully.



Throughout the manual, this symbol guides you step by step when operating the appliance.



This symbol indicates further information concerning the use of the appliance.



The clover indicates energy-saving tips and hints for environmentally friendly use of your appliance.

In the event of malfunctioning, please follow the instructions given in the section «What to do if...»

# Contents

Important safety instructions .....	2 - 4
Oven & accessories .....	5
Control panel .....	6
Before operation .....	7
Setting the clock .....	7
What are microwaves? .....	8
Suitable ovenware .....	8 - 9
Tips & advice .....	10 - 14
Microwave power levels .....	15
Microwave cooking .....	16
Grill & dual grill cooking .....	17
Other convenient functions .....	18 - 19
Auto cook & defrost operation .....	20 - 21
Auto cook & defrost charts .....	22 - 24
Recipes for auto cook .....	25 - 26
Cooking charts .....	27 - 28
Recipes .....	29 - 35
Care & cleaning .....	36
What to do if... ..	36
Service & spare parts .....	37
Customer care .....	37
Guarantee conditions .....	38
Specifications .....	39
Important information .....	39
Installation .....	40 - 41



The symbol  on the product or on its packaging indicates that this product may not be treated as household waste. Instead it shall be handed over to the applicable collection point for the recycling of electrical and electronic equipment. By ensuring this product is disposed of correctly, you will help prevent potential negative consequences for the environment and human health, which could otherwise be caused by inappropriate waste handling of this product. For more detailed information about recycling of this product, please contact your local city office, your household waste disposal service or the shop where you purchased the product.



# Important safety instructions

## IMPORTANT SAFETY INSTRUCTIONS: READ CAREFULLY AND KEEP FOR FUTURE REFERENCE

### To avoid the danger of fire

**The microwave oven should not be left unattended during operation. Power levels that are too high or cooking times that are too long may overheat foods resulting in a fire.**

The electrical outlet must be readily accessible so that the unit can be unplugged easily in an emergency. Do not store or use the oven outdoors.

**If food being heated begins to smoke, DO NOT OPEN THE DOOR. Turn off and unplug the oven and wait until the food has stopped smoking. Opening the door while food is smoking may cause a fire.**

**Only use microwave-safe containers and utensils. See Page 8 - 9.**

**Do not leave the oven unattended when using disposable plastic, paper or other combustible food containers.**

**Clean the waveguide cover, the oven cavity, the turntable and turntable support after use. These must be dry and free from grease. Built-up grease may overheat and begin to smoke or catch fire.**

Do not place flammable materials near the oven or ventilation openings. Do not block the ventilation openings.

Remove all metallic seals, wire twists, etc., from food and food packages. Arcing on metallic surfaces may cause a fire.

Do not use the microwave oven to heat oil for deep frying. The temperature cannot be controlled and the oil may catch fire.

To make popcorn, only use special microwave popcorn makers.

Do not store food or any other items inside the oven.

Check the settings after you start the oven to ensure the oven is operating as desired.

See the corresponding hints in this operation manual.

### To avoid the possibility of injury

#### **WARNING:**

Do not operate the oven if it is damaged or malfunctioning. Check the following before use:

- a) The door; make sure the door closes properly and ensure it is not misaligned or warped.
- b) The hinges and safety door latches; check to make sure they are not broken or loose.
- c) The door seals and sealing surfaces; ensure that they have not been damaged.
- d) Inside the oven cavity or on the door; make sure there are no dents.
- e) The power supply cord and plug; ensure that they are not damaged.

**Never adjust, repair or modify the oven yourself. It is hazardous for anyone other than a competent person to carry out any service or repair operation which involves the removal of a cover which gives protection against exposure to microwave energy.**

Do not operate the oven with the door open or alter the door safety latches in any way.

Do not operate the oven if there is an object between the door seals and sealing surfaces.

**Do not allow grease or dirt to build up on the door seals and adjacent parts. Follow instructions for "Care and Cleaning", Page 36. Failure to maintain the oven in a clean condition could lead to a deterioration of the surface that could adversely affect the life of the appliance and possibly result in a hazardous situation.**

Individuals with PACEMAKERS should check with their doctor or the manufacturer of the pacemaker for precautions regarding microwave ovens.

#### **To avoid the possibility of electric shock**

Under no circumstances should you remove the outer cabinet.

Never spill or insert any objects into the door lock openings or ventilation openings. In the event of a spill, turn off and unplug the oven immediately and call your local Service Force Centre.

Do not immerse the power supply cord or plug in water or any other liquid.

Do not allow the power supply cord to run over any hot or sharp surfaces, such as the hot air vent area at the top rear of the oven.



# Important safety instructions

Do not attempt to replace the oven lamp yourself or allow anyone who is not authorised by Service Force to do so. If the oven lamp fails, please consult your dealer or contact your local Service Force Centre.

If the power supply cord of this appliance is damaged, it must be replaced with a special cord. The exchange must be made by an authorised Service Force technician.

**To avoid the possibility of explosion and sudden boiling:**

**WARNING: Liquids and other foods must not be heated in sealed containers since they are liable to explode.**

Never use sealed containers. Remove seals and lids before use. Sealed containers can explode due to a build up of pressure even after the oven has been turned off.

Take care when microwaving liquids. Use a wide-mouthed container to allow bubbles to escape.

**Microwave heating of beverages can result in delayed eruptive boiling, therefore care has to be taken when handling the container.**

**To prevent sudden eruption of boiling liquid and possible scalding:**

1. Stir liquid prior to heating/reheating.
2. It is advisable to insert a glass rod or similar utensil into the liquid whilst reheating.
3. Let liquid stand for at least 20 seconds in the oven at the end of cooking time to prevent delayed eruptive boiling.

**Do not cook eggs in their shells, and whole hard boiled eggs should not be heated in microwave ovens since they may explode even after microwave cooking has ended. To cook or reheat eggs which have not been scrambled or mixed, pierce the yolks and the whites, or the eggs may explode. Shell and slice hard boiled eggs before reheating them in the microwave oven.**

Pierce the skin of such foods as potatoes, sausages and fruit before cooking, or they may explode.

**To avoid the possibility of burns**

Use pot holders or oven gloves when removing food from the oven to prevent burns.

Always open containers, popcorn makers, oven cooking bags, etc., away from the face and hands to avoid steam burns.

**To avoid burns, always test food temperature and stir before serving and pay special attention to the temperature of food and drink given to babies, children or the elderly.**

Temperature of the container is not a true indication of the temperature of the food or drink; always check the food temperature.

Always stand back from the oven door when opening to avoid burns from escaping steam and heat.

Slice stuffed baked foods after heating to release steam and avoid burns.

Keep children away from the door and accessible parts that may become hot when the grill is in use. Children should be kept away to prevent them burning themselves.

Do not touch the oven door, outer cabinet, rear cabinet, oven cavity, ventilation openings, accessories and dishes during **GRILL** mode, **DUAL GRILL** mode and **AUTO COOK** operation as they will become hot. Before cleaning make sure they are not hot.

**To avoid misuse by children**

**Warning: Only allow children to use the oven without supervision when adequate instructions have been given so that the child is able to use the oven in a safe way and understands the hazards of improper use.**

Do not lean or swing on the oven door. Do not play with the oven or use it as a toy.

Children should be taught all important safety instructions: use of pot holders, careful removal of food coverings; paying special attention to packaging (e.g. self-heating materials) designed to make food crisp, as they may be extra hot.

**Other warnings**

Never modify the oven in any way.

This oven is for home food preparation only and may only be used for cooking food. It is not suitable for commercial or laboratory use.

**To promote trouble-free use of your oven and avoid damage.**

Never operate the oven when it is empty except where recommended in the operation manual, see page 17 note 2. Doing so may damage the oven.

When using a browning dish or self-heating material, always place a heat-resistant insulator such as a porcelain plate under it to prevent damage to the turntable and turntable support due to heat stress. The preheating time specified in the dish's instructions must not be exceeded.



## Important safety instructions

Do not use metal utensils, which reflect microwaves and may cause electrical arcing. Do not put cans in the oven.

Only use the turntable and the turntable support designed for this oven. Do not operate the oven without the turntable.

To prevent the turntable from breaking:

- (a) Before cleaning the turntable with water, leave the turntable to cool.
- (b) Do not put hot foods or hot utensils on a cold turntable.
- (c) Do not put cold foods or cold utensils on a hot turntable.

Do not place anything on the outer cabinet during operation.

Do not use plastic containers for microwaving if the oven is still hot from using the **GRILL** mode, **DUAL GRILL** mode and **AUTO COOK** operation, because they may melt. Plastic containers must not be used during above modes unless the container manufacturer says they are suitable.

**NOTE:**

If you are unsure how to connect your oven, please consult an authorised, qualified electrician.

Neither the manufacturer nor the dealer can accept any liability for damage to the oven or personal injury resulting from failure to observe the correct electrical connection procedure.

Water vapour or drops may occasionally form on the oven walls or around the door seals and sealing surfaces. This is a normal occurrence and is not an indication of microwave leakage or a malfunction.

# Oven & accessories

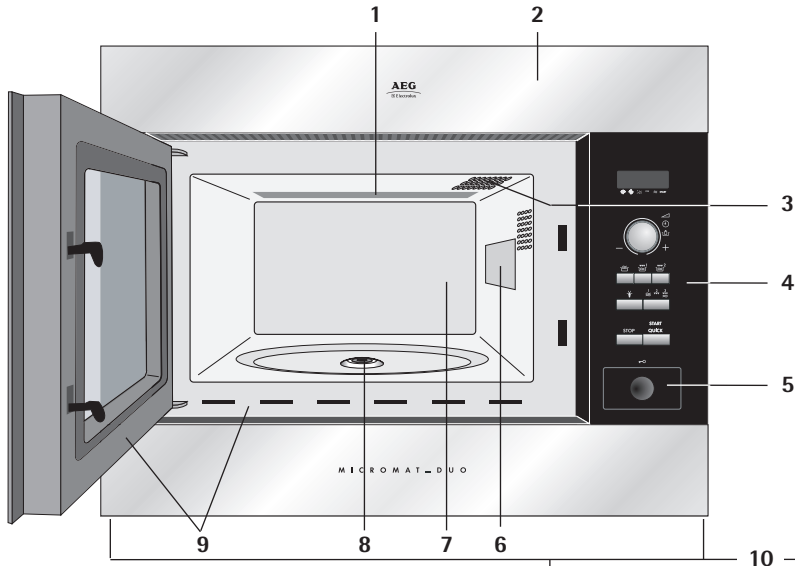

1. Grill heating element
2. Front trim
3. Oven lamp
4. Control panel
5. Door opening button
6. Waveguide cover
7. Oven cavity
8. Seal packing
9. Door seals and sealing surfaces
10. Fixing points (4 points)

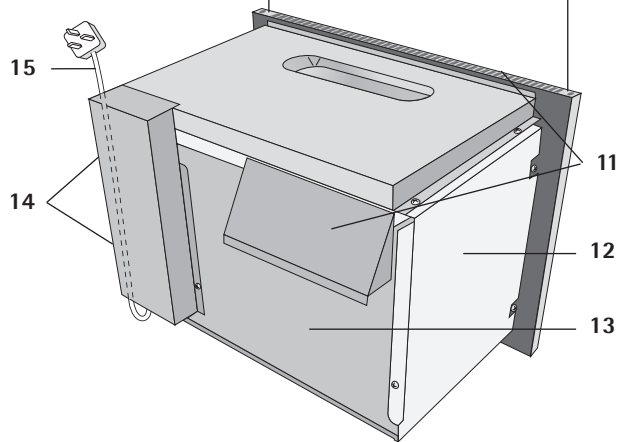

## ACCESSORIES:

Check to make sure the following accessories are provided:

(16) Turntable support (17) Turntable support (18) High rack (19) Low rack (20) 4 fixing screws (not shown)

- Place the turntable support in the seal packing on the floor of the cavity.
- Then place the turntable on the turntable support.
- To avoid turntable damage, ensure dishes or containers are lifted clear of the turntable rim when removing them from the oven.

**NOTE:** When you order accessories, please mention two items: part name and model name to your dealer or local Service Force Centre.

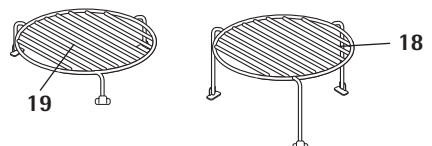
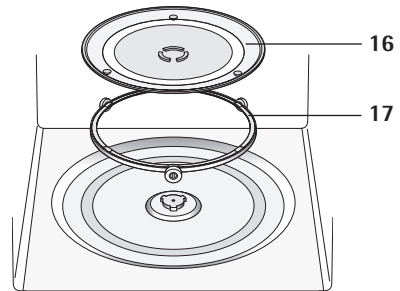



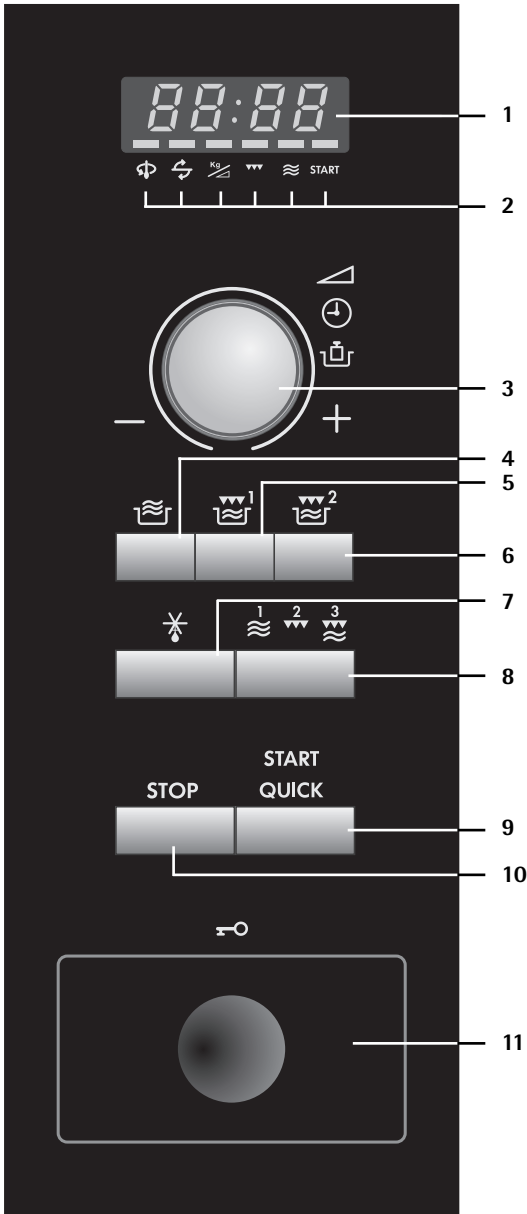



# Control panel



## 1 Digital Display

## 2 Indicators

The appropriate indicator will flash or light up, just above each symbol according to the instruction. When an indicator is flashing, press the appropriate button (having the same symbol) or carry out the necessary operation.

-  Stir
-  Turn over
-  Weight/power level
-  Grill
-  Microwave
-  Cooking in progress

## 3 TIMER/WEIGHT/POWER knob

## 4 AUTO COOK button

Press to select one of the 2 automatic programmes.

## 5 AUTO COOK PLUS GRILL 1 button

Press to select one of the 2 automatic programmes.

## 6 AUTO COOK PLUS GRILL 2 button

Press to select one of the 3 automatic programmes.

## 7 AUTO DEFROST button

Press to select one of the 5 automatic programmes.

## 8 COOKING MODE button

Press to select either microwave, grill or dual grill, or use to set the clock.

1. press once to select microwave function.
2. press twice to select the grill.
3. press three times to select dual grill mode, microwave with grill.

## 9 START/QUICK button

## 10 STOP button

## 11 DOOR OPENING button



# Before operation

Plug in the oven.

1. The oven display will flash:

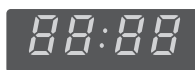

2. Press the **STOP** button, the display will show:



3. To set the clock, see below.

4. Heat the oven without food. (See page 17 note 2).

## Using the STOP button

Use the **STOP** button to:

1. Erase a mistake during programming.
2. Stop the oven temporarily during cooking.
3. Cancel a programme during cooking, touch twice.

# Setting the clock

There are two setting modes: 12 hour clock and 24 hour clock.

1. To set the 12 hour clock, hold the **COOKING MODE** button down for 3 seconds.

 will appear in the display.

2. To set the 24 hour clock, press the **COOKING MODE** button once more after

Step 1, in the example below  will appear in the display.

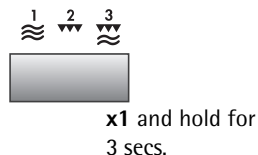

To set the clock, follow the example below.

**Example:** To set the 24 hour clock to 23:35.

1. Choose the clock function. (12 hour clock).

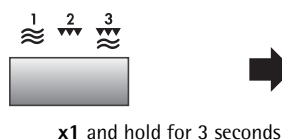

- Choose the 24 hour clock.

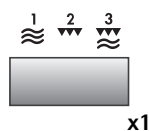

2. Set the hours. Rotate the **TIMER/WEIGHT/POWER** knob until the correct hour is displayed (23).

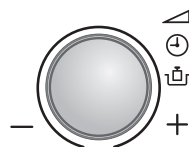

3. Press the **COOKING MODE** button to change from hours to minutes.

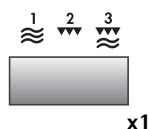

4. Set the minutes. Rotate the **TIMER/WEIGHT/POWER** knob until the correct minute is displayed (35).

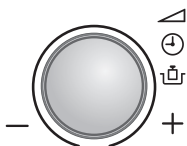

5. Press the **COOKING MODE** button to start the clock.



## NOTES:

1. You can rotate the **TIMER/WEIGHT/POWER** knob clockwise or counter-clockwise.
2. Press the **STOP** button if you make a mistake during programming.
3. If the electrical power supply to your microwave oven is interrupted, the display will intermittently show  after the power is reinstated. If this occurs during cooking, the programme will be erased. The time of day will also be erased.
4. When you want to reset the time of day, follow the above example again.

## **i** What are microwaves?

### What are microwaves?

Like radio and television waves, microwaves are electromagnetic waves.

Microwaves are produced by a magnetron inside the microwave oven, and these vibrate the molecules of water present in the food. The friction this causes produces heat, which ensures that the food is defrosted, heated or cooked through.

The secret of the reduced cooking times is the fact that the microwaves penetrate the food from every direction. Energy is used to the full. In comparison, the energy from a conventional hob passes from the burner through the pan and so to the food. This method wastes a great deal of energy.

### The characteristics of microwaves

Microwaves penetrate all non-metal objects made of glass, china, earthenware, plastic, wood or paper. This is why the microwaves never make these materials hot. Dishes become hot only because the food inside them is hot.

The food absorbs the microwaves and is heated.

Microwaves cannot pass through objects made of metal and so they are deflected. For this reason metal objects are not normally suitable for microwave cookery. There are exceptions where you can actually make use of the fact that the microwaves cannot pass through metal. If you cover food with aluminium foil at specific points while it is defrosting or cooking, you can prevent those parts from getting too warm, too hot, or overcooked. Please check out the advice given in the guide.

## **i** Suitable ovenware

### Glass & ceramic glass

Heat-resistant glass utensils are very suitable. The cooking process can be observed from all sides. They must not, however, contain any metal (e.g. lead crystal), nor have a metallic overlay (e.g. gold edge, cobalt blue finish).

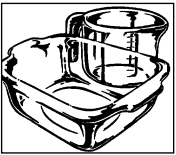

### Ceramics

Generally very suitable. Ceramics must be glazed, since with unglazed ceramics moisture can get into the ceramic. Moisture causes the material to heat up and may make it shatter. If you are not certain whether your utensil is suitable for the microwave, carry out the utensil suitability test. (See page 9).

### Porcelain

Very suitable. Ensure that the porcelain does not have a gold or silver overlay and that it does not contain any metal.

### Plastic utensils

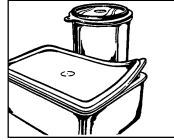

Heat resistant plastic utensils which are suitable for use in the microwave can be used to thaw, heat and cook food. Follow the manufacturer's recommendations.

### Paper utensils

Heat resistant paper made for use in a microwave oven is also suitable. Follow the manufacturer's recommendations.

### Kitchen paper

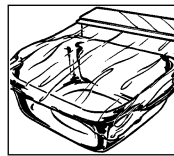

can be used to absorb any moisture which occurs in short heating methods, e.g. of bread or products in bread crumbs. Insert the paper between the food and the revolving plate. The surface of the food will stay crispy and dry. Covering greasy food with kitchen paper will catch splashes.

## **i** Suitable ovenware

### **Microwave cling film**

This, or heat-resistant film, is very suitable for covering or wrapping. Please follow the manufacturer's recommendations.

### **Roasting bags**



Can be used in a microwave oven. Metal clips are not suitable for fastening them since the roasting bag foil might melt. Fasten the roasting bag with string and pierce it several times with a fork. Non heat-resistant food wraps are not recommended for use in a microwave oven.

### **The right utensils for combined operation**

For combined operation (Microwave + grill) and grill operation, you can use any heat-resistant accessories, e. g. porcelain, pottery, glass. It is possible to use metal accessories only for a simple grill operation.

### **Browning dish**

A special microwave dish made from ceramic glass with a metal alloy base, which allows food to be browned. When using the browning dish a suitable insulator, e.g. a porcelain plate, must be placed between the turntable and the browning dish. Be careful to adhere exactly to the pre-heating time given in the manufacturer's instructions. Excessive pre-heating can damage the turntable and the turntable stand or can trigger the safety-device which will switch off the oven.

### **Metal**

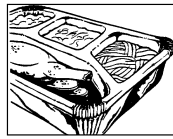

Generally speaking, metal should not be used, since microwaves do not pass through metal and therefore cannot reach the food. There are, however, exceptions: small strips of aluminium foil may be used to cover certain parts of the food, so that these do not thaw too quickly or begin to cook (e.g. chicken wings). Small metal skewers and aluminium containers (e.g. of readycooked meals) can be used. They must, however, be small in relation to the food, e.g. aluminium containers must be at least 2/3 to 3/4 filled with food. It is recommended that you transfer the food into a dish suitable for use in the microwave.



When using aluminium containers or other metal utensils there must be a gap of approx. 2 cms between them and the walls of the cooking area, otherwise the walls could be damaged by possible arcing.

**NO UTENSIL SHOULD HAVE A METAL** overlay, or metal parts such as screws, bands or handles.

### **Utensil suitability test**

If you are not sure whether your utensil is suitable for use in your microwave oven, carry out the following test: Place the utensil into the oven. Place a glass container filled with 150 ml of water on or next to the utensil.

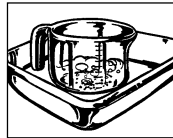

Switch on the oven at 900 W power for 1 to 2 minutes. If the utensil stays cool or just warm to the touch, it is suitable. Do not use this test on a plastic utensil. It could melt.

## **i** Tips & advice

### Before you start...

To make it as easy as possible to use the microwave oven we have put together a few hints and tips for you. Only switch on the oven when the food is already inside.

### Setting the cooking time

Defrosting, re-heating and cooking times are generally much shorter than in a conventional oven or hob. So you will need to consult this book for the recommended cooking times. It is better to set shorter rather than longer cooking times. Always test the food after the cooking time has elapsed. It is better then to continue cooking it for a little longer, than to have overcooked food.

### Starting temperature

Defrosting, re-heating and cooking times depend on the temperature of the food when you start. For example, deep frozen and re-fridgerated food will need longer than food that is at room temperature. Standard storage temperatur of food are assumed for re-heating and cooking times (refridgerator temperature of 5° C, Room temperature of approximately 20° C). For defrosting food a starting temperature of -18° C is assumed.

Cook **popcorn** only in special microwave safe containers. Refer exactly to the manufacturer's instructions. Do not use a normal paper or glass



container. Do not cook **eggs** in the unbroken shells. Pressure builds up inside the shell and this may result in the egg exploding.

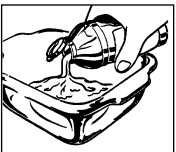

Do not heat **oil or fat** for deep-frying inside the microwave oven. It is impossible to control the temperature of the oil and it may suddenly splash out of the pan.

Do not heat **sealed containers** such as jars or tins. The pressure inside the container could cause the container to explode. (The exception is when you are making preserves).

### Cooking times

All the times given in this book are guidelines, which can be varied according to the initial temperature, weight and condition of the food (water or fat content etc.).

### Salt, spices & herbs

Food cooked in your microwave retains its individual flavour better than it does when conventional preparation methods are used. For this reason you should use salt sparingly and normally add it only after cooking. Salt absorbs liquid and dries out the outer layer of food. Herbs and spices can be used as normal.

### Types of use

**Microwave:** you can defrost frozen foods in a short time.

**Combined operation:** With the combination of microwave and grill you can cook and roast at the same time. Therefore, the advantages of these appliances will combine sensibly and mutually. The heat of the grill quickly seals the pores of the food and the microwave functions for a short time. The food keeps its moisture inside and is crispy on the outside.

**Grill:** Your oven is provided with a quartz grill, which you can also use without microwave operation like any other conventional grill.

### Cooking test

The cooking status of meals can be tested as with conventional preparation:

- **Food thermometer:** Each food has a certain interior temperature at the end of the heating process. With a food thermometer you can determine whether the food is hot or cooked enough.
- **Fork:** You can check fish with a fork. If the fish meat is no longer clear and comes easily from the fishbones, it is. If it is over-cooked, it becomes tough and dry.
- **Wooden skewer:** Cakes and bread can be tested by inserting a wooden skewer. If the skewer remains clean and dry after pulling it out they are done.

## **i** Tips & advice

### Using a food thermometer to determine cooking time

The internal temperature of food and drink can be ascertained with a food thermometer. The most important temperatures are specified in the temperature table.

Drink / Food	Internal temperature once cooked	Internal temp. after 10 - 15 mins standing time
Heating drinks (Coffee, Water, Tea, etc.)	65-75° C	
Heating Milk	60-65° C	
Heating soup	75-80° C	
Heating stew	75-80° C	
Poultry	80-85° C	85-90° C
Lamb		
Pink	70° C	70-75° C
Well done	75-80° C	80-85° C
Roast beef		
Rare	50-55° C	55-60° C
Medium	60-65° C	65-70° C
Well done	75-80° C	80-85° C
Pork, Veal	80-85° C	80-85° C

### Addition of water

Vegetables and other foods with a high water content can be cooked in their own juice or with the addition of a little water. This ensures that many vitamins and minerals are preserved.

### Food in skin or shells

Foods such as sausages, chickens, chicken legs, baked potatoes, tomatoes, apples, egg yolks or such like should be pricked or pierced with a fork or small wooden skewer. This will enable the steam which forms to dissipate without splitting the skin or shell.

### Fatty foods

Fatty meat and layers of fat cook better than lean portions of meat. Before cooking, cover the fatty portions with a piece of aluminium foil or place the food with the fat side down.

### Blanching vegetables

Before freezing vegetables, they should be blanched.

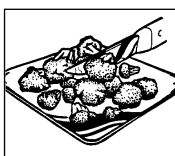

This preserves the quality and flavour at their best. Method: wash and chop the vegetables. Put 250g of vegetables in a dish with 275 ml water and cover. Heat for 3-5 minutes. After blanching, immerse immediately in cold water to prevent further cooking and then allow to drain. Pack vegetables in an airtight container and freeze.

### Preserving fruit and vegetables

Using the microwave for preserving is quick and easy. There are preserving jars, rubber vacuum seals and suitable seals made of plastic available specially made for microwaves. The manufacturers will supply precise instructions for use.

### Large & small quantities

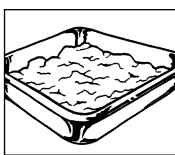

Microwave times are directly dependent upon the amount of food which you would like to thaw, heat or cook. This means that small portions cook more quickly than larger ones. As a rule of thumb:

TWICE THE AMOUNT = ALMOST TWICE THE TIME

HALF THE AMOUNT = HALF THE TIME

### Deep & shallow containers

Both containers have the same capacity, but the cooking time is longer for the deeper one. You should therefore choose as flat a container as possible with a large surface area. Only use deep containers for dishes where there is a danger of overcooking, e.g. for noodles, rice, milk etc.

### Round & oval containers

Food cooks more evenly in round or oval containers than in containers with corners, since the microwave energy concentrates in the corners and the food in these areas could become overcooked.

## **i** Tips & advice

### **Covering**

Covering the food retains the moisture within it and shortens the cooking time. Use a lid, microwave cling film or a cover. Foods which are to be crispy, e.g. roasts or chickens, should not be covered. As a general rule, whatever would be covered in a conventional oven should also be covered in a microwave oven. Whatever would be uncovered in a conventional oven can also be left uncovered in a microwave oven.

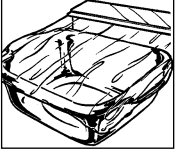

### **Irregular shaped food**

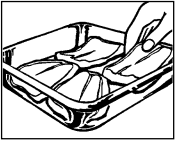

Place the thicker, more compacted end of the food pointing towards the outside. Place vegetables (such as broccoli) with the stalks pointing outward.

### **Stirring**



Stirring the food is necessary, since the microwaves begin by heating the outer areas. The temperature is thereby equalised and the food heats up evenly.

### **Arrangement of food**

Place a number of individual portions, such as small pudding moulds, cups or potatoes in their jackets, in a circle on the turntable. Keep the portions at a distance from each other so that the microwave energy can reach the food from all sides.

### **Turning**

Medium-sized items, such as hamburgers and steaks, should be turned over once during cooking, in order to shorten the cooking process. Large items, such as roasts and chickens, must be turned, since the upper side receives more microwave energy and could dry out if not turned.

### **Standing time**

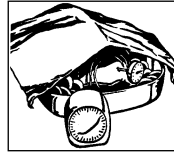

Keeping to the standing time is one of the most important rules with microwaves. Almost all foods, which are thawed, heated or cooked in the microwave, require a certain amount of time to stand, during which temperature equalisation takes place and the moisture in the food is evenly distributed.

## **i** Heating

- Ready-prepared meals in aluminium containers should be removed from the aluminium container and heated on a plate or in a dish.
- Food should be covered with microwave cling film, a plate or cover (obtainable from stores), so that the surface does not dry out. Drinks need not be covered.
- Remove the lids from firmly closed containers.
- When boiling liquids such as water, coffee, tea or milk, place a glass stirrer in the container.
- If possible, stir large quantities from time to time, to ensure that the temperature is evenly distributed.
- The times are for food at a room temperature of 20° C. The heating time for food stored in a refrigerator should be increased slightly.
- After heating allow the food to stand for 1-2 minutes, so that the temperature inside the food can be evenly distributed (standing time).
- The times given are guidelines which can be varied according to the initial temperature, weight, water content, fat content or the result which you wish to achieve.

## **i** Defrosting

Your microwave is ideal for defrosting. Defrosting times are usually considerably shorter than in traditional methods. Here are a few tips. Take the frozen item out of its packaging and place on a plate for defrosting.

### **Boxes & containers**

Boxes and containers suitable for microwaves are particularly good for defrosting and heating food, since they can withstand temperatures in a deep freeze (down to approx. -40° C) as well as being heat-resistant (up to approx. 220° C). You can therefore use the same container to freeze, defrost, heat and even cook the food, without having to transfer it.

### **Covering**

Cover thin parts with small strips of aluminium foil before defrosting. Defrosted or warm parts should likewise be covered with aluminium strips during defrosting. This stops the thin parts becoming too hot while thicker parts are still frozen.

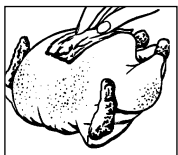

### **Correct setting**

It is better to choose a setting which is too low rather than one which is too high. By so doing you will ensure that the food defrosts evenly. If the microwave setting is too high, the surface of the food will already have begun to cook while the inside is still frozen.

### **Turning/stirring**

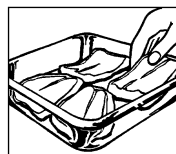

Almost all foods have to be turned or stirred from time to time. As early as possible, separate parts which are stuck together and rearrange them.

### **Small amounts...**

defrost more quickly and evenly than larger ones. We recommend that you freeze portions which are as small as possible. By so doing you will be able to prepare whole menus quickly and easily.

### **Foods requiring careful handling,**

such as gateaux, cream, cheese and bread should only be partially defrosted and then left to defrost completely at room temperature. By so doing you will avoid the outer areas becoming too hot while the inside is still frozen.

### **Standing time**

This is particularly important after defrosting food, as the defrosting process continues during this period. In the defrosting table you will find the standing times for various foods. Thick, dense foods require a longer standing time than thinner foods or food of a porous nature. If the food has not defrosted sufficiently, you may continue defrosting it in the microwave oven or lengthen the standing time accordingly. At the end of the standing time you should process the food as soon as possible and not re-freeze it.

## **i** Cooking fresh vegetables

- When buying vegetables try to ensure that, as far as possible, they are of similar size. This is particularly important when you want to cook the vegetables whole (e.g. boiled potatoes).
- Wash the vegetables before preparing them, clean them and only then weigh the required quantity for the recipe and chop them up.
- Season them as you would normally, but as a rule only add salt after cooking.
- Add about 5 tbsps of water for 500 g of vegetables. Vegetables which are high in fibre require a little more water. You will find information about this in the table (see page 27).
- Vegetables are usually cooked in a dish with a lid. Those with a high moisture content, e.g. onions or boiled potatoes, can be cooked in microwave cling film without adding water.
- After half the cooking time has elapsed vegetables should be stirred or turned over.
- After cooking allow the vegetables to stand for approx. 2 minutes, so that the temperature disperses evenly (standing time).
- The cooking times given are guidelines and depend upon the weight, initial temperature and condition of the type of vegetable in question. The fresher the vegetables, the shorter the cooking times.

## **i** Cooking meat, fish & poultry

- When buying food items, try to ensure that, as far as possible, they are of similar size. This will ensure that they are cooked properly.
- Before preparation wash meat, fish and poultry thoroughly under cold running water and pat them dry with kitchen paper. Then continue as normal.
- Beef should be well hung and have little gristle.
- Even though the pieces may be of a similar size, cooking results may vary. This is due, amongst other things, to the kind of food, variations in the fat and moisture content as well as the temperature before cooking.
- Turn large pieces of meat, fish or poultry half way through the cooking time, so that they are cooked evenly from all sides.
- After cooking cover roasts with aluminium foil and allow them to stand for approx. 10 minutes (standing time). During this period the roast carries on cooking and the liquid is evenly distributed, so that when it is carved a minimum amount of juice is lost.

## **i** Defrosting & cooking

Deep-frozen dishes can be defrosted and cooked at the same time in one process in your microwave. You will find some examples in the table. Do take note, however, of the general advice given on "heating" and "defrosting" food.

Please refer to the manufacturer's instructions on the packaging when preparing deep-frozen dishes. These usually contain precise cooking times and offer advice on preparation.



## **i** Microwave power levels

Your oven has 5 power levels. To choose the power level for cooking, follow the advice given in the recipe section. Generally the following recommendations apply:

**900 W** used for fast cooking or reheating e.g. soup, casseroles, canned food, hot beverages, vegetables, fish, etc.

**630 W** used for longer cooking of dense foods such as roast joints, meat loaf and plated meals, also for sensitive dishes such as cheese sauce and sponge cakes. At this reduced setting, the sauce will not boil over and food will cook evenly without over cooking at the sides.

**450 W** for dense foods which require a long cooking time when cooked conventionally, eg. beef dishes, it is advisable to use this power setting to ensure the meat will be tender.

**270 W** (Defrost setting) to defrost, select this power setting, to ensure that the dish defrosts evenly. This setting is also ideal for simmering rice, pasta, dumplings and cooking egg custard.

**90 W** For gentle defrosting, eg. cream gateaux or pastry.

W = WATT

To set the microwave power level :

Rotate the **TIMER/WEIGHT/POWER** knob clockwise or counter-clockwise to select cooking time.

Press the **COOKING MODE** button once (microwave only).

To change the microwave power level rotate the knob until the desired power level is reached.

Press the **START/QUICK** button.

**NOTE:** If the power level is not selected, 900 W is automatically set.

# Microwave cooking

Your oven can be programmed for up to 90 minutes. (90.00) The input unit of cooking (defrosting) time varies from 10 seconds to five minutes. It depends on the total length of the cooking (defrosting) time as shown on the table.

### Cooking time

0-5 minutes  
5-10 minutes  
10-30 minutes  
30-90 minutes

### Increasing unit

10 seconds  
30 seconds  
1 minute  
5 minutes

### Example:

Suppose you want to heat soup for 2 minutes and 30 seconds on 630 W microwave power.

1. Enter desired cooking time by rotating **TIMER/WEIGHT/POWER** knob clockwise.
2. Choose desired cooking mode by pressing **COOKING MODE** button once (microwave only).
3. Choose desired power by rotating the **TIMER/WEIGHT/POWER** knob clockwise.
4. Press **START/QUICK** button once to begin cooking.

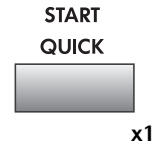
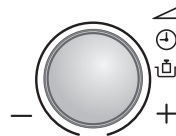
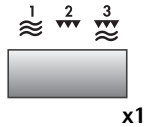
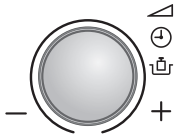

### NOTE:

1. When the door is opened during the cooking process, the cooking time on the digital display stops automatically. The cooking time starts to count down again when the door is closed and the **START/QUICK** button is pressed.
2. If you wish to know the power level during cooking, press the **COOKING MODE** button. As long as your finger is touching the **COOKING MODE** button, the power level will be displayed.
3. You can rotate the **TIMER/WEIGHT/POWER** knob clockwise or counter-clockwise. If you rotate the knob counter-clockwise, the cooking time will decrease from 90 minutes by degrees.

# Grill & dual grill cooking

This microwave oven has two **GRILL** cooking modes: 1. Grill only. 2. Dual Grill (Grill with microwave).

## 1. GRILL ONLY COOKING

This mode can be used to Grill/Brown food.

**Example:** To make toast for 4 minutes.

1. Enter desired cooking time by rotating the **TIMER/WEIGHT/POWER** knob.
2. Choose the desired cooking mode by pressing the **COOKING MODE** button twice. (Grill only).
3. Press the **START/QUICK** button once to begin cooking.

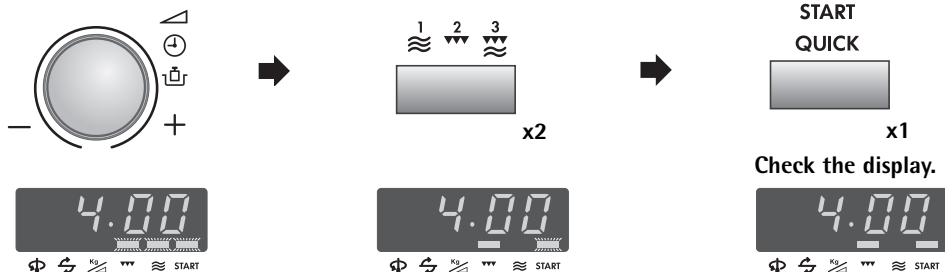

### NOTES:

1. The high or the low rack is recommended for grilling.
2. You may detect smoke or a burning smell when using the grill for the first time, this is normal and not a sign that the oven is out of order.  
To avoid this problem, when first using the oven, operate the grill without food for 20 minutes.

## 2. DUAL GRILL COOKING

This mode uses a combination of Grill power and Microwave power (90 W to 630 W).  
The microwave power level is preset to 270 W.

**Example:** To cook grill skewers (see recipe on page 26) for 7 minutes on **DUAL GRILL** (450 W).

1. Enter the desired cooking time by rotating the **TIMER/WEIGHT/POWER** knob.
2. Choose the desired cooking mode by pressing the **COOKING MODE** button three times (Dual Grill).
3. Rotate the **TIMER/WEIGHT/POWER** knob to the desired microwave power level.
4. Press the **START/QUICK** button once to begin cooking.

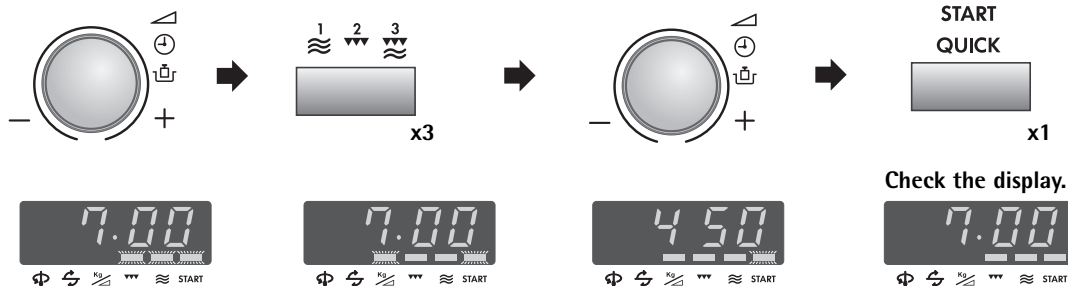

# 👉 Other convenient functions

## 1. MULTIPLE SEQUENCE COOKING

A sequence of 3 stages (maximum) can be programmed using combinations of **MICROWAVE**, **GRILL** or **DUAL GRILL**.

### Example:

To cook: 2 minutes and 30 seconds on 630 W power (Stage 1)  
5 minutes Grill only (Stage 2)

#### STAGE 1

1. Enter the desired cooking time by rotating **TIMER/WEIGHT/POWER** knob.
2. Choose the desired cooking mode by pressing **COOKING MODE** button once (microwave only).
3. Enter the desired power level by rotating **TIMER/WEIGHT/POWER** knob.
4. Press the **COOKING MODE** button before programming Stage 2.

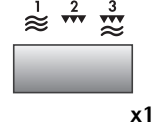
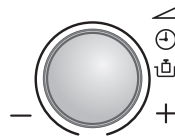
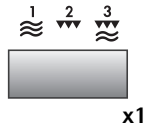
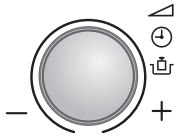

Check the display.

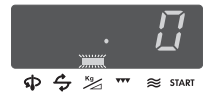

#### STAGE 2

5. Enter desired time by rotating **TIMER/WEIGHT/POWER** knob.
6. Choose the desired cooking mode by pressing the **COOKING MODE** button twice (Grill only).
7. Press **START/QUICK** button once to begin cooking.

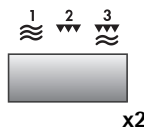
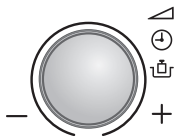

Check the display.



(The oven will begin to cook for 2 minutes and 30 seconds at 630 W, and then for 5 minutes on Grill only.)

**NOTE:** If you set any programme after setting **GRILL** mode, omit the steps 3 and 4.

If you press the **COOKING MODE** button continually after setting **GRILL** mode, the **GRILL** mode will be changed to the **DUAL GRILL** mode automatically.

### Example:

To cook 1.0 kg Courgette & Noodle Gratin (see recipe on page 32).

1. 18 minute at 900 W.
2. 7 minutes Dual Grill at 630 W.

## Other convenient functions

### 2. QUICK START FUNCTION

The **START/QUICK** button allows you to operate the two following functions:

#### a. Direct start

You can directly start cooking on 900 W microwave power level for 30 seconds by pressing the **START/QUICK** button.



#### NOTE:

To avoid the misuse by children the **START/QUICK** button can be used only within 3 minutes after preceding operation, i.e., closing the door, pressing the **STOP** button or cooking completion.

#### b. Extend the cooking time

You can extend the cooking time during manual cooking for multiples of 30 seconds if the **START/QUICK** button is pressed while the oven is in operation.

### 3. TO CHECK THE POWER LEVEL

To check the microwave power level during cooking press the **COOKING MODE** button.

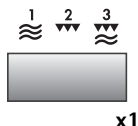

As long as your finger is touching the **COOKING MODE** button the power level will be displayed.

The oven continues to count down although the display shows the power level.

### 4. SAFETY LOCK FUNCTION

#### TO SET THE SAFETY LOCK FUNCTION

1. Press and hold the **STOP** key for 3 seconds.



x1 for 3 seconds

The display will show:



#### TO CANCEL THE SAFETY LOCK FUNCTION

1. Press and hold the **STOP** key for 3 seconds.



x1 for 3 seconds

The display will show the time of day, if set.

**NOTE:** When Safety Lock is set you cannot input any buttons except the **STOP** button.

# Auto cook & auto defrost operation

**AUTOCOOK** and **AUTO DEFROST** automatically work out the correct cooking mode and cooking time. You can choose from 2 **AUTOCOOK**, 6 **AUTOCOOK plus GRILL** and 4 **AUTO DEFROST** menus.

What you need to know when using this automatic function:

**For example:**

**1a. AUTO COOK:** The **AUTO COOK** button has two menus. Press the **AUTO COOK** button once, the display will appear as shown.

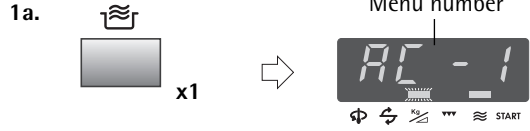

**1b. AUTO COOK plus GRILL 1:** The **AUTO COOK PLUS GRILL 1** button has two menus. Press the **AUTO COOK PLUS GRILL 1** button once, the display will appear as shown.

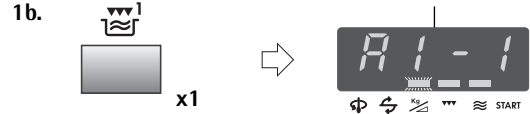

**1c. AUTO COOK plus GRILL 2:** The **AUTO COOK PLUS GRILL 2** button has four menus. Press the **AUTO COOK PLUS GRILL 2** button once, the display will appear as shown.

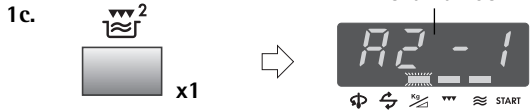

**1d. AUTO DEFROST:** The **AUTO DEFROST** button has four menus. Press the **AUTO DEFROST** button once, the display will appear as shown.

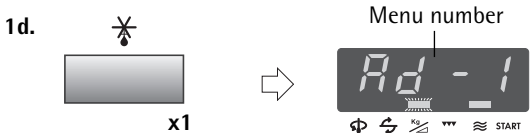

The menu can be chosen by pressing the **AUTO DEFROST** or desired **AUTO COOK** button until the desired menu number is displayed. See pages 22 - 24 "AUTO COOK & AUTO DEFROST charts".

The menu will be changed automatically by holding down the **AUTO COOK** or **AUTO DEFROST** button.

2. The weight or quantity of the food can be input by rotating the **TIMER/WEIGHT/POWER** knob until the desired weight/quantity is displayed.

- Enter the weight of the food only. Do not include the weight of the container.
- For food weighing more or less than weights/quantities given in the **AUTOCOOK & AUTO DEFROST** charts, use manual operation. For best results, follow the cooking charts on pages 27 - 28.

3. To start cooking press **START/QUICK** button.

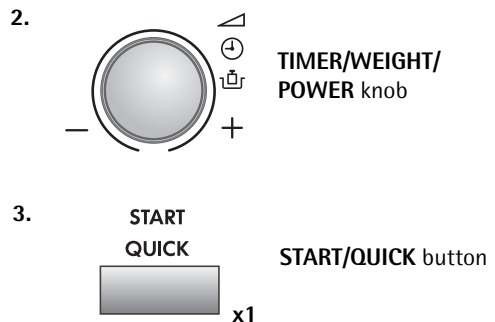

When action is required (e.g. to turn food over) the oven stops and the audible signals sound, remaining cooking time and any indicator will flash on the display. To continue cooking, press the **START/QUICK** button.

The final temperature will vary according to the initial temperature. Check food is piping hot after cooking. If necessary, you can extend the cooking time and change the power level.

**NOTE:** If you use the **ADD 30 SECONDS** function during the cooking/defrosting, the food may be overcooked.

# Auto cook & auto defrost operation

## Example 1 for AUTO COOK plus GRILL 1:

To cook Gratinated Fish Fillet 1,5 kg using Auto Cook plus Grill 1 (A1-1).

1. Select the menu required by pressing the **AUTO COOK PLUS GRILL 1** button once.
2. Enter the weights by rotating the **TIMER/WEIGHT/POWER** knob.
3. Press the **START/QUICK** button once.

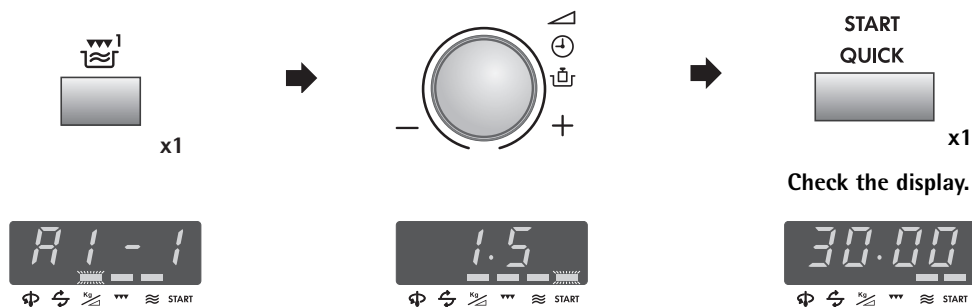





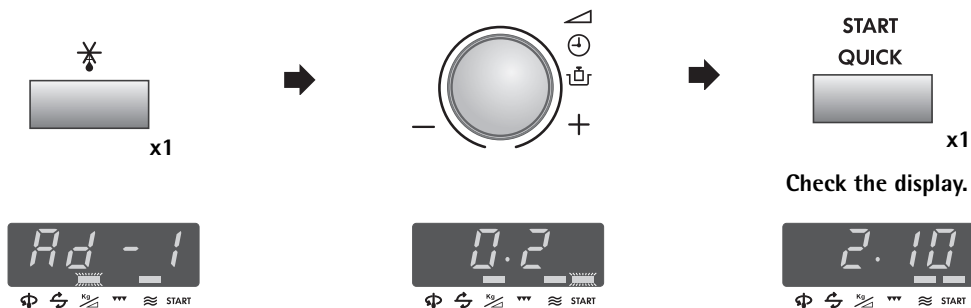

## Example 2 for AUTO DEFROST:







To defrost Steak 0,2 kg using Auto Defrost (Ad-1).

1. Select the menu required by pressing the **AUTO DEFROST** button once.
2. Enter the weight by rotating the **TIMER/WEIGHT/POWER** knob.
3. Press the **START/QUICK** button once.











## **i** Auto cook & auto defrost charts

BUTTON	AUTO COOK	WEIGHT (Increasing Unit) / UTENSILS	PROCEDURE
  <b>x1</b>	<b>AC-1 Cook</b> Chicken Pan with Vegetables 	0,5 - 1,5 kg* (500 g) (initial temp Chicken 5° C) Gratin dish with microwave cling film	<ul style="list-style-type: none"> <li>• See recipe for "Chicken Pan with Vegetables" on page 25.</li> <li>* Total weight of all ingredients.</li> </ul>
  <b>x2</b>	<b>AC-2 Cook</b> Mince and Onion 	0,5 - 1,5 kg* (500 g) (initial temp Mince 5° C) Casserole dish with lid	<ul style="list-style-type: none"> <li>• See recipe for "Mince and Onion" on page 25.</li> <li>* Total weight of all ingredients.</li> </ul>













BUTTON	AUTO COOK plus GRILL 1	WEIGHT (Increasing Unit) / UTENSILS	PROCEDURE
  <b>x1</b>	<b>A1-1 Cook</b> Gratinated Fish Fillet 	0,5 - 1,5 kg* (500 g) (initial temp Fish 5° C) Gratin dish Low rack	<ul style="list-style-type: none"> <li>• See recipes for "Gratinated Fish Fillet" on pages 25 - 26.</li> <li>* Total weight of all ingredients.</li> </ul>
  <b>x2</b>	<b>A1-2 Cook</b> Gratin 	0,5 - 1,5 kg* (500 g) (initial temp 20° C) Gratin dish Low rack	<ul style="list-style-type: none"> <li>• See recipes for "Gratin" on page 26.</li> <li>* Total weight of all ingredients.</li> </ul>



## **i** Auto cook & auto defrost charts

BUTTON	AUTO COOK plus GRILL 2	WEIGHT (Increasing Unit) / UTENSILS	PROCEDURE
 x1	<b>A2-1 Cook</b> French Fried Potatoes Thick type (recommended for conventional ovens) 	0,20 - 0,40 kg (50 g) (initial temp -18° C) Flan dish High rack	<ul style="list-style-type: none"> <li>Remove the frozen french fried potatoes from the package and place them on a flan dish.</li> <li>Place the dish on the high rack in the oven.</li> <li>When the audible signals sound, turn over.</li> <li>After cooking, remove from the dish and put on a plate for serving. (No standing time is necessary).</li> <li>Add salt to taste.</li> </ul> <p><b>NOTE:</b> The dish gets very hot during cooking. To avoid burning yourself, please use oven gloves for removing the flan dish from the oven.</p>
 x2	<b>A2-2 Cook</b> Grill Skewers See recipe on page 26. 	0,2 - 0,8 kg (100 g) (initial temp 5° C) High rack	<ul style="list-style-type: none"> <li>Prepare the grill skewers.</li> <li>Place on the high rack and cook.</li> <li>When the audible signal sounds turn over.</li> <li>After cooking, remove and put on a plate for serving. (No standing time necessary).</li> </ul>
 x3	<b>A2-3 Cook</b> Chicken Legs  <p>Ingredients for 0,6 kg chicken legs:            3 pieces, 1-2 tbsp oil, 1/2 tsp salt,            1 tsp sweet paprika, 1 tsp rosemary</p>	0,20- 0,80 kg (50 g) (initial temp 5° C) High rack	<ul style="list-style-type: none"> <li>Mix the ingredients and spread on the chicken legs.</li> <li>Pierce the skin of the chicken legs.</li> <li>Put the chicken legs on the high rack, skin side down, with the thin ends towards the centre.</li> <li>When audible signals sound, turn the food over.</li> <li>After cooking, remove and stand for approximately 5 minutes.</li> </ul>
 x4	<b>A2-4 Cook</b> Grilled Chicken  <p>Ingredients for 1,2 kg grilled chicken:            Salt &amp; pepper, 1 tsp sweet paprika,            2 tbsp oil</p>	0,9 - 1,8 kg (100 g) (initial temp 5° C) Low rack	<ul style="list-style-type: none"> <li>Mix the ingredients and spread on the chicken.</li> <li>Pierce the skin of the chicken.</li> <li>Put chicken breast side down on the low rack.</li> <li>When audible signals sound, turn the chicken over.</li> <li>After cooking, leave for approx. 3 minutes in the oven, remove and put on a plate for serving.</li> </ul>

# **i** Auto cook & auto defrost charts

BUTTON	AUTO DEFROST NO.	WEIGHT (Increasing Unit) / UTENSILS	PROCEDURE
  <b>x1</b>	<b>Ad-1 Defrost</b> Steak and Chops 	0,2 - 1,0 kg (100 g) (initial temp -18° C) (See note below)	<ul style="list-style-type: none"> <li>Place the food on a plate in the centre of the turntable.</li> <li>When the oven stops and the audible signals sound, turn the food over, rearrange and separate. Shield thin parts and warm spots with aluminium foil.</li> <li>After defrosting, wrap in aluminium foil for 10 - 15 minutes, until thoroughly defrosted.</li> </ul>
  <b>x2</b>	<b>Ad-2 Defrost</b> Minced Meat 	0,2 - 1,0 kg (100 g) (initial temp -18° C) Cling film (See note below)	<ul style="list-style-type: none"> <li>Cover the turntable with cling film.</li> <li>Place the block of minced meat onto the turntable.</li> <li>When the oven stops and the audible signals sound, turn the food over. Remove the defrosted parts if possible.</li> <li>After defrosting, stand for 5 - 10 minutes, until thoroughly defrosted.</li> </ul>
  <b>x3</b>	<b>Ad-3 Defrost</b> Cake 	0,1 - 1,4 kg (100 g) (initial temp -18° C) Flat dish	<ul style="list-style-type: none"> <li>Remove all packaging from the cake.</li> <li>Place on a flat dish in the middle of the turntable.</li> <li>After defrosting, cut the cake into similar sized pieces keeping space between each piece and let stand for 15 - 60 minutes until evenly defrosted.</li> </ul>
  <b>x4</b>	<b>Ad-4 Defrost</b> Bread 	0,1 - 1,0 kg (100 g) (initial temp -18° C) Flat dish (Only sliced bread is recommended for this programme.)	<ul style="list-style-type: none"> <li>Distribute on a flat dish in the centre of the turntable.</li> <li>When the audible signal sounds rearrange, and remove defrosted slices.</li> <li>After defrosting separate all slices and distribute on a large plate. Cover the bread with aluminium foil and let stand for 5 - 10 minutes until thoroughly defrosted.</li> </ul>

## NOTE: Auto Defrost

- Steaks and Chops should be frozen in one layer.
- Minced meat should be frozen in a thin shape.
- After turning over, shield the defrosted portions with small, flat pieces of aluminium foil.
- Gateaux topped and coated with cream are very sensitive to microwave energy. For the best result, if the cream begins to soften rapidly, it is best to remove it from the oven immediately and stand for 10 - 30 minutes at room temperature.
- For Steaks and Chops arrange the food in the oven as shown:

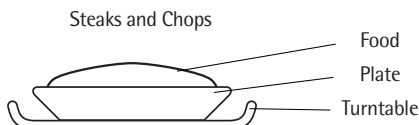

# **i** Recipes for auto cook

## **CHICKEN PAN WITH VEGETABLES (AC-1)**

### **Spicy chicken fricassee**

#### **Ingredients**

0,5 kg	1,0 kg	1,5 kg	
60 g	120 g	180 g	long grain rice (parboiled)
1	1	1	sachet saffron
25 g	50 g	75 g	onion (sliced)
50 g	100 g	150 g	red pepper (in strips)
50 g	100 g	150 g	leek (in strips)
150 g	300 g	450 g	fillet of chicken breast (cubed)
			pepper, paprika powder
10 g	20 g	30 g	butter or margarine
150 ml	300 ml	450 ml	meat stock

#### **Preparation**

1. Mix the rice and saffron and place in the greased dish.
2. Mix the onions, red pepper, leek and chicken. Season and place on the rice.
3. Put butter on the top.
4. Pour the stock over and cover with microwave cling film and cook on **AUTO COOK (AC-1)**, "Chicken Pan with Vegetables".
5. After cooking, let stand for 5-10 minutes.

## **MINCE AND ONION (AC-2)**

#### **Ingredients**

0,5 kg	1,0 kg	1,5 kg	
150 g	300 g	450 g	minced meat (1/2 beef, 1/2 pork)
50 g	100 g	150 g	onion (finely chopped)
1/2	1	1 1/2	egg
15 g	30 g	45 g	white breadcrumbs
			salt and pepper
115 ml	230 ml	345 ml	meat stock
20 g	40 g	60 g	tomato purée
65 g	125 g	190 g	potatoes (finely chopped)
65 g	125 g	190 g	carrots (finely chopped)
1/2 tbsp	1 tbsp	1 1/2 tbsp	chopped parsley

#### **Preparation**

1. Mix together the minced meat, onion, egg and the breadcrumbs. Season with salt and pepper. Place the meat dough into a casserole.
2. Mix the meat stock with the tomato purée.
3. Add the liquid, potatoes, carrots and parsley to the meat, mix it up well.
4. Cover and cook on **AUTO COOK (AC-2)**, "Mince and Onion".
5. When the oven stops and the audible signals sound, stir and re-cover.
6. After cooking, stir and stand for approx. 5 minutes. Sprinkle with parsley and serve.

## **GRATINATED FISH FILLET (A1-1)**

### **Fish gratin Italian style**

#### **Ingredients**

0,5 kg	1,0 kg	1,5 kg	
200 g	430 g	630 g	fish fillet
1/2 tbsp	1 tbsp	1 1/2 tbsp	lemon juice
1/2 tbsp	1 tbsp	1 1/2 tbsp	anchovy butter
30 g	50 g	80 g	Gouda (grated)
			salt and pepper
150 g	300 g	450 g	fresh tomatoes
1 tbsp	1 1/2 tbsp	2 tbsp	chopped mixed herbs
100 g	180 g	280 g	Mozarella
1/2 tbsp	3/4 tbsp	1 tbsp	Basil (chopped)

#### **Preparation**

1. Wash and dry the fish and sprinkle with lemon juice, salt and anchovy butter.
2. Place in a gratin dish (size depends on weight).
3. Sprinkle the Gouda over the fish.
4. Wash the tomatoes and remove the stalk-spore. Cut into slices and place on top of the cheese.
5. Season with salt, pepper and the mixed herbs.
6. Drain the Mozarella, cut into slices and place on the tomatoes. Sprinkle the basil over the cheese.
7. Place the gratin dish on the low rack and cook on **AUTO COOK plus GRILL 1 (A1-1)**, "Gratinated fish fillet".
8. After cooking, let stand for approximately 5 minutes.

# **i** Recipes for auto cook

## **GRATINATED FISH FILLET (A1-1)**

### **Fish esterhazy**

#### Ingredients

0,5 kg	1,0 kg	1,5 kg	
230 g	450 g	680 g	fish fillet
100 g	200 g	300 g	leeks (cut into rings)
20 g	40 g	60 g	onion (finely sliced)
40 g	100 g	140 g	carrot (grated)
10 g	10 g	20 g	butter or margarine
			salt, pepper and nutmeg
1 tbsp	1 1/2 tbsp	2 tbsp	lemon juice
50 g	100 g	150 g	crème fraîche
50 g	100 g	150 g	Gouda (grated)

#### Preparation

- Put vegetables, butter and the spices into a casserole dish and mix well. Cook for 2-6 minutes on 900 W depending on weight.
- Wash the fish, dry and sprinkle with lemon juice and salt.
- Mix the crème fraîche with the vegetables and season again.
- Put half of the vegetables in a gratin dish. Place the fish on top and cover with the remaining vegetables.
- Spread the Gouda over the top, place on the low rack and cook on **AUTO COOK plus GRILL 1 (A1-1)**, "Gratinated fish fillet".
- After cooking, let stand for approximately 5 minutes.

## **GRATIN (A1-2)**

### **Spinach gratin**

#### Ingredients

0,5 kg	1,0 kg	1,5 kg	
150 g	300 g	450 g	leaf spinach (defrosted, drained)
15 g	30 g	45 g	onion (finely chopped)
			salt, pepper, nutmeg
150 g	300 g	450 g	boiled potatoes (sliced)
35 g	75 g	110 g	cooked ham (diced)
50 g	100 g	150 g	crème fraîche
1	2	3	eggs
40 g	75 g	115 g	grated cheese

#### Preparation

- Mix together the leaf spinach with the onion and season with salt, pepper and nutmeg.
- Grease the gratin dish. Place alternate layers of potato slices, diced ham and spinach in the dish. The top layer should be spinach.
- Mix the eggs with crème fraîche, add salt and pepper and pour over the vegetables.
- Cover the gratin with the grated cheese.
- Place on the low rack and cook on **AUTO COOK plus GRILL 1 (A1-2)**, "Gratin".
- After cooking, let stand for 5-10 minutes.

## **GRATIN (A1-2)**

### **Potato-courgette-gratin**

#### Ingredients

0,5 kg	1,0 kg	1,5 kg	
200 g	400 g	600 g	boiled potatoes (sliced)
115 g	230 g	345 g	courgette (finely sliced)
75 g	150 g	225 g	crème fraîche
1	2	3	eggs
1/2	1	2	clove of garlic (crushed)
			salt, pepper
40 g	80 g	120 g	grated Gouda cheese
10 g	20 g	30 g	sunflower kernel

#### Preparation

- Grease the gratin dish and place alternate layers of potato slices and courgette in the dish.
- Mix the eggs with crème fraîche, season with salt, pepper and garlic and pour over the vegetables.
- Cover the gratin dish with the grated Gouda cheese.
- Finally sprinkle the gratin with sunflower kernel.
- Place on the low rack and cook on **AUTO COOK plus GRILL 1 (A1-2)**, "Gratin".
- After cooking, let stand for 5-10 minutes.

## **GRILL SKEWERS**

#### Ingredients

4 pieces	
400 g	escalope of pork
100 g	smoked belly of pork
2	onions (100 g), quartered
4	tomatoes (250 g), quartered
1/2	green pepper (100 g), in eight pieces
2 tbsp	oil
4 tsp	sweet paprika
	salt
1 tsp	cayenne pepper
1 tsp	worcester sauce

#### Preparation

- Cut the escalope of pork and the pork belly into 2-3 cm cubes.
- Thread meat and vegetables alternately on four wooden skewers.
- Combine the oil with the spices and brush over the kebabs.
- Place the kebabs on the high rack and cook on **AUTO COOK plus GRILL 2 (A2-2)**, "Grill Skewers".

# Cooking charts

## ABBREVIATIONS USED

tblsp = tablespoon	Cup = cupful	g = gram	ml = millilitre	min = minutes
tsp = teaspoon	KG = kilogram	l = litre	cm = centimetre	

### TABLE: HEATING FOOD & DRINK

Food / Drink	Quantity -g/ml-	Setting	Power -Level-	Time -Min-	Hints
Coffee, 1 cup	150		900 W	approx. 1	Do not cover
Milk, 1 cup	150		900 W	approx. 1	Do not cover
Water, 1 cup	150		900 W	approx. 2	Do not cover, bring to the boil
6 cups	900		900 W	8-10	Do not cover, bring to the boil
1 dish	1000		900 W	9-11	Cover, bring to the boil
One-plate meal (Veg, Meat + side dishes)	400		900 W	4-6	Sprinkle sauce with water, cover, stir half way through cooking time
Soup / Stew	200		900 W	1-2	Cover, stir after heating
Vegetables	200		900 W	2-3	Add water if necessary, cover, stir half way through cooking time
	500		900 W	3-5	
Side dishes	200		900 W	2-3	Sprinkle with a little water, cover, stir half way through cooking time
	500		900 W	4-5	
Meat, 1 slice <sup>1</sup>	200		900 W	approx. 3	Sprinkle with a little sauce, cover
Fish fillet	200		900 W	3-5	Cover
Cake, 1 slice	150		450 W	1/2-1	Place on a plate
Baby food, 1 jar	190		450 W	1/2-1	Remove lid, stir well after heating
					Check the temperature
Melting Margarine or Butter <sup>1</sup>	50		900 W	1/2	Cover
Melting chocolate	100		450 W	3-4	Stir during cooking

<sup>1</sup> from chilled

### TABLE: COOKING FRESH VEGETABLES

Vegetable	Quantity -g-	Setting	Power -Level-	Time -Min-	Hints	Added water -Tbsps/ml-
Broccoli	500		900 W	6-8	divide into florets, cover, stir occasionally during cooking	4-5 tbsps
Peas	500		900 W	6-8	cover, stir occasionally during cooking	4-5 tbsps
Onions	250		900 W	4-5	whole, cook in microwave cling film	-
Carrots	500		900 W	9-11	cut into rings, cover, stir occasionally during cooking	4-5 tbsps
Boiled potatoes (salted)	500		900 W	7-9	cut into large pieces of a similar size, add a little salt, cover, stir occasionally during cooking	150 ml

### TABLE: DEFOSTING

Food	Quantity -g-	Power -Setting-	Time -Min-	Hints	Standing time -Min-
Goulash	500	270 W	8-9	stir halfway through defrosting time	10-15
Sausages, 8 pieces	600	270 W	6-8	place next to each other, turn over halfway through defrosting time	5-10
4 pieces	300	270 W	3-5		5-10
Chicken legs	200	270 W	3-4	turn over halfway through defrosting time	10-15
Fish fillet	400	270 W	5-7	turn over halfway through defrosting time	5-10
Bread rolls, 2 pieces	80	270 W	1-1 1/2	only begin to defrost	-
Cake, 1 piece	150	270 W	1-3	place on a plate	5
Fruit e.g. strawberries	250	270 W	3-5	place next to each other, spread out evenly	5
raspberries, cherries, plums				turn over halfway through defrosting time	

The times shown in the table are guidelines which may vary according to freezing temperature, quality and weight of the foodstuffs.

# Cooking charts

## TABLE: DEFROSTING AND COOKING

Food	Quantity -g-	Power -Setting-	Time -Min-	Added water -tbsps-	Hints	Standing time -Min-
Fish fillet	300	900 W	9-11	-	cover	1-2
One Plate Meal	400	900 W	8-10	-	cover, stir after 6 minutes	2
Broccoli	300	900 W	6-8	3-5	cover, stir halfway through cooking time	2
Peas	300	900 W	6-8	3-5	cover, stir halfway through cooking time	2
Mixed vegetables	500	900 W	9-11	3-5	cover, stir halfway through cooking time	2

## TABLE: COOKING, GRILLING & BROWNING

Food	Quantity -g-	Setting	Power -Level-	Time -Min-	Hints	Standing time -Min-
Roasts (Pork, Veal, Lamb)	500		450 W	5-8	Season to taste, place on the low rack, turn over after *.	10
			450 W	6-8*		
			450 W	5-8		
			450 W	4-5		
	1000		450 W	16-18		
			450 W	5-7*		
			450 W	14-16		
			450 W	4-6		
1500		450 W	26-28	10		
		450 W	5-8*			
		450 W	26-28			
		450 W	4-5			
Roast beef (medium)	1000		630 W	5-8	Season to taste, place fatty side down on the low rack turn over after *.	10
			630 W	8-10*		
			630 W	3-5		
	1500		630 W	12-15		
			630 W	12-15*		
			630 W	4-6		
Chicken	1200		900 W	9-11	Season to taste, place breast side down on the low rack, turn over after *.	3
			630 W	5-7*		
			900 W	9-11		
			630 W	3-5		
Chicken legs	200		450 W	6-7*	Season to taste, place skin side down on the high rack, turn over after *.	3
	450 W	4-6				
Rump steaks 2 pieces, medium	400			11-12*	Place on the high rack, turn over after *, season after grilling.	
		6-8				
Browning of gratin dishes				8-13	Place gratin dish on the low rack. The grilling time depends on the type of cheese used.	
Croque Monsieur	1 piece		450 W	1/2	Toast the bread and spread it with butter; top with a slice of cooked ham, a slice of pineapple and a slice of cheese. Prick the centre and place on the high rack.	
			450 W	5-6		
	4 pieces		450 W	1/2-1		
			450 W	5-6		
Frozen Pizza	300		450 W	4-6	Place on the low rack.	
			450 W	4-6		
	400		450 W	6-7		
			450 W	5-7		

# Recipes

All the recipes in this book are calculated on the basis of 4 servings - unless otherwise stated.

## ADAPTING RECIPES FOR THE MICROWAVE OVEN

If you would like to adapt your favourite recipes for the microwave, you should take note of the following: Shorten cooking times by a third to a half. Follow the example of the recipes in this book.

Foods which have a high moisture content such as meat, fish, poultry, vegetables, fruit, stews and soups can be prepared in your microwave without any

difficulty. Foods which have little moisture, such as platters of food, should have the surface moistened prior to heating or cooking.

The amount of liquid to be added to raw foods, which are to be braised, should be reduced to about two thirds of the quantity in the original recipe. If necessary, add more liquid during cooking.

The amount of fat to be added can be reduced considerably. A small amount of butter, margarine or oil is sufficient to flavour food. For this reason your microwave is excellent for preparing low-fat foods as part of a diet.



### Onion soup

Total cooking time: approx. 14 - 17 minutes

Utensils: Bowl with lid (2 litre capacity)  
4 soup bowls (200 ml)

Ingredients

1 tbsp butter or margarine  
2 onions (100 g), sliced  
800 ml meat stock  
salt & pepper  
2 slices of bread for toasting  
4 tbsp grated cheese (40 g)

1. Place the butter cut up into pieces in the bowl. Add the sliced onion, the meat stock and the seasoning. Cover and microwave.  
**9-11 min.**  **900 W**
2. Toast the slices of bread, cut them into cubes and divide them among the soup bowls. Pour the soup over the toast cubes and sprinkle on the cheese.
3. Place the bowls on the turntable, use the top grill and brown the cheese topping.  
**6-7 min.** 





### Mushrooms with rosemary

Total cooking time: approx. 10-17 minutes

Utensils: Bowl with lid (1 litre capacity)  
Shallow round dish with lid  
(approx. 22 cm diameter)

Ingredients

8 large mushrooms (approx. 225 g), whole  
2 tbsp butter or margarine (20 g)  
1 onion (50 g), finely chopped  
50 g bacon, finely diced  
black pepper, ground  
fresh rosemary, bruised  
125 ml dry white wine  
125 ml cream  
2 tbsp flour (20 g)

1. Remove the stalks from the mushrooms and chop the stalks into small pieces.
2. Spread the butter on the bottom of the dish. Add the onions, the diced bacon and the mushroom stalks. Season with pepper and rosemary, cover and cook.  
**3-5 min.**  **900 W**  
Leave to cool.
3. Heat 100 ml of the wine and cream in the other dish with its lid on.  
**1-3 min.**  **900 W**
4. Mix the remaining wine with the flour, stir into the hot liquid and cook with the lid on. Stir once during cooking.  
**approx. 1 min.**  **900 W**
5. Fill the mushrooms with the bacon mixture, place in the sauce and cook on the high rack.  
**6-8 min.**   **270 W**  
Allow the mushrooms to stand for approximately 2 minutes once cooked.

# Recipes

## Zurich veal stew

Total cooking time: approx. 9-14 minutes

Utensils: Bowl with lid (2 litre capacity)

Ingredients

- 600 g veal fillet
- 1 tbsp butter or margarine
- 1 onion (50 g), finely chopped
- 100 ml white wine
- gravy thickener to make approx. 1/2 litre
- 300 ml cream
- 1 tbsp parsley, chopped

## Fillet of sole

2 portions

Total cooking time: approx. 11-13 minutes

Utensils: Shallow oval gratin dish with lid  
(approx. 26 cm long)

Ingredients

- 400 g fillet of sole
- 1 lemon, untreated
- 2 tomatoes (150 g)
- 1 tsp butter or margarine to grease the dish
- 1 tbsp vegetable oil
- 1 tbsp parsley, chopped
- salt & pepper
- 4 tbsp white wine (30 ml)
- 2 tbsp butter or margarine (20 g)

## Aubergines stuffed with minced meat



Total cooking time: approx. 17-22 minutes

Utensils: Bowl with lid (1 litre size)  
Shallow oval gratin dish with lid  
(approx. 30 cm long)

Ingredients

- 2 aubergines, less stalks (app. 250 g)
- 3 tomatoes (app. 200 g)
- 1 tbsp olive oil to grease the dish
- 2 onions (100 g), chopped
- 4 mild green chillies
- 200 g mince (beef or lamb)
- 2 garlic cloves, crushed
- 2 tbsp parsley, chopped
- salt & pepper
- pink paprika
- 60 g Feta cheese, diced

Tip: You can substitute courgettes for the aubergines.

1. Slice the meat into finger-thick strips.
2. Smear the butter evenly around the dish. Add the onion and the meat to the dish, cover and cook. Stir once during cooking.  
**6-9 min.**  **900 W**
3. Add the white wine, the gravy powder and the cream, stir, cover and continue to cook. Stir once during cooking.  
**3-5 min.**  **900 W**
4. Taste the stew, stir again and allow to stand for 5 minutes. Serve with parsley garnish.

1. Wash the fish and pat dry. Remove any bones.
2. Slice the lemon and the tomatoes finely.
3. Grease the gratin dish with butter. Place the fish in it and drizzle with vegetable oil.
4. Sprinkle the fish with parsley, lay the slices of tomato on top and season. Lay the slices of lemon on top of the tomato and pour the white wine over this.
5. Dot the lemon with butter, cover and cook.  
**11-13 min.**  **630 W**  
Leave the fish fillets to stand for 2 minutes after cooking.

Tip: You can also use rosefish, halibut, mullet, plaice or cod in this recipe.

1. Cut the aubergines in half lengthways. Scoop out the flesh with a teaspoon to leave a shell about 1 cm thick. Sprinkle the aubergines with salt and dice the scooped-out flesh.
2. Remove the skin from two of the tomatoes and chop them up, having first cut out the stalks.
3. Grease the bottom of the bowl with the olive oil. Add the onions. Cover and cook.  
**approx. 2 min.**  **900 W**
4. Remove the stalks and seeds from the chillies and cut them into rings. Retain a third for the garnish. Mix the minced meat with the diced aubergines, onions and tomatoes, the chilli rings, the crushed garlic clove and the parsley. Season to taste.
5. Dry the aubergine halves. Fill with half of the mince mixture, spread the sheep's cheese on top, and then add the rest of the filling.
6. Arrange the aubergine halves in the greased ovenproof dish, place the dish on the low rack and cook.  
**11-13 min.**   **630 W**  
Garnish the aubergine halves with the chilli rings and slices of tomato and continue cooking.  
**4-7 min.**   **630 W**  
Allow the aubergines to stand for about 2 minutes after cooking.



# Recipes

## Stuffed ham

Total cooking time: approx. 13-18 minutes

Utensils: Bowl with lid (2 litre capacity)  
Shallow oval gratin dish  
(approx. 26 cm long)

### Ingredients

150 g fresh spinach, stalks removed  
150 g quark, 6 % fat  
50 g grated Emmental cheese  
pepper, paprika, mild  
6 slices cooked ham (300 g)  
125 ml water  
125 ml cream  
2 tbsp flour (20 g)  
2 tbsp Butter or Margarine (20 g)  
1 tsp Butter or Margarineto grease the dish

Tip: You can also use ready-made béchamel sauce for this recipe

## Fish fillet with cheese sauce

Total cooking time: approx. 21-25 minutes

Utensils: Bowl with lid (1 litre capacity)  
Shallow oval gratin dish  
(approx. 25 cm long)

### Ingredients

4 fish fillets (approx. 800 g)  
(e.g. perch, flounder or cod)  
2 tbsp lemon juice  
salt  
1 tbsp butter or margarine  
1 onion (50 g), finely chopped  
2 tbsp flour (20 g)  
100 ml white wine  
1 tsp vegetable to grease the dish  
100 g grated Emmental cheese  
2 tbsp chopped parsley

## Almond trout

Total cooking time: approx. 16-19 minutes

Utensils: Shallow oval gratin dish  
(ca. 32 cm lang)

### Ingredients

4 trout (200 g), trimmed  
juice of one lemon  
salt  
30 g butter or margarine  
5 tbsp flour (50 g)  
1 tsp butter or margarine to grease the dish  
50 g almond flakes

1. Cut the spinach finely, mix with the quark and the cheese and season to taste.
2. Place a tablespoon of the filling on each slice of the cooked ham and roll up. Secure the ham with a wooden toothpick.
3. Make a béchamel sauce. To do this, pour the liquid into the dish, cover and heat.

**2-4 min.**  **900 W**

Rub the butter into the flour, add to the liquid and beat with a balloon whisk, until it is smooth. Cover, bring to the boil until thickened.

**1-2 min.**  **900 W**

Stir and taste.

4. Pour the sauce into the greased dish, place the ham rolls in the dish and cook on the turntable.

**10-12 min.**  **630 W**

Allow the ham rolls to stand for approximately 5 minutes after cooking.

1. Wash the fish, pat dry and sprinkle with lemon juice. Leave to stand for 15 minutes, pat dry again and rub with salt.
2. Smear the butter on the bottom of the dish. Add the diced onion, cover with the lid and steam.
3. Sprinkle the flour over the onions and stir. Add the white wine and mix.
4. Grease the gratin dish and place the fish in it. Pour the sauce over the fish and sprinkle with cheese. Place on the low rack and cook.

**1. 7-8 min.**  **450 W and then**

**2. 14-16 min.**  **450 W**

Allow fish to stand for approximately 2 minutes after cooking. Serve with a garnish of chopped parsley.

1. Wash and dry the trout and sprinkle with lemon juice. Apply salt to the interior and exterior of the fish and leave to stand for 15 minutes.

2. Melt the butter.

**1 min.**  **900 W**

3. Dry the fish, spread on the butter and roll in the flour.
4. Grease the dish. Put the trout in the dish and cook on the low rack. Two thirds through the cooking period turn the trout and scatter the almonds over them.

**15-18 min.**  **450 W**

Allow the almond trout to stand for 2 minutes after cooking.

Tip: Suitable accompanying dishes are parsley potatoes and a green salad.

# Recipes

## Veal cutlet with mozzarella

Total cooking time: approx. 24-31 minutes

Utensils: Shallow square gratin dish with lid  
(approx. 25 cm long)

### Ingredients

- 2 mozzarella cheese (150 g)
- 500 g drained, peeled tinned tomatoes
- 4 veal cutlets (600 g)
- 20 ml olive oil
- 2 cloves of garlic, sliced
- pepper, freshly milled
- 2 tbsp capers (20 g)
- oregano, salt

1. Cut the mozzarella into slices. Puree the tomatoes with the puree attachment of a hand mixer.
2. Wash the cutlets, dry them and beat them flat. Distribute the oil and the garlic slices over the bottom of the oven-proof dish. Add the cutlets and pour over the tomato puree. Sprinkle with pepper, capers and oregano, cover and cook on the low rack.

**15-19 min.**  **630 W**

Turn the meat slices.

3. Place a few slices of mozzarella on each piece of meat, add salt and cook uncovered on the high rack.

**9-12 min.**   **630 W**

After cooking allow to stand for about 5 minutes.

## Stuffed Roast Chicken

2 portions

Total cooking time: approx. 36-40 minutes

Utensils: Bowl (2 litre capacity)  
String

### Ingredients

- 1 chicken (1000 g)
- salt
- rosemary & majoram, bruised
- 1 stale bread (roll, 40 g)
- 1 bunch parsley, finely chopped (10 g)
- 1 pinch nutmeg
- 5 tbsp butter or margarine (50 g)
- 1 egg yolk
- 1 tbsp sweet paprika
- 1 tsp butter or margarine to grease the dish

1. Wash the chicken, dry it and season it internally with salt, rosemary and marjoram.
2. For the filling soak the bread roll in cold water for about 10 minutes and then squeeze the water out. Mix with salt, parsley, nutmeg, butter (20 g) and egg yolk and stuff the chicken with the mixture. Tie up the opening with string.

3. Heat the butter (30 g).

**ca. 1 min.**  **900 W**

Stir the paprika and salt into the butter and spread over the chicken.

4. Place chicken in the greased dish and cook. Turn over halfway through cooking.

**35-39 min.**  **630 W**

Leave the stuffed roast chicken to stand for approx. 3 minutes after cooking.

## Courgette and noodle gratin

Total cooking time: approx. 37-44 minutes

Utensils: Bowl with lid (2 l Inhalt)  
Gratin dish (approx. 26 cm long)

### Ingredients

- 500 ml water
- 1/2 tsp oil
- 80 g macaroni
- 400 g tinned chopped tomatoes
- 3 onion (150 g), finely chopped
- basil, thyme, salt & pepper
- 1 tbsp oil to grease the dish
- 450 g courgettes, sliced
- 150 g sour cream
- 2 eggs
- 100 g grated Cheddar cheese

1. Put the water, oil and salt in the bowl, cover and bring to the boil.

**3-4 min.**  **900 W**

2. Break the macaroni into pieces and add them to the dish. Stir and allow to soak.

**9-11 min.**  **270 W**

Drain the pasta and allow to cool.

3. Mix the tomatoes with the onions and season well. Add the macaroni and pour over the tomato sauce. Divide the courgette slices on top.

4. Beat the sour cream and the eggs and pour over the dish. Sprinkle the grated cheese on top. Place on the low rack and cook.

**1. 18-21 min.**  **900 W**

and then

**2. 7-8 min.**   **630 W**

Allow the gratin to stand for about 5-10 minutes after cooking.

# Recipes

## Lasagne al forno

Total cooking time: approx. 18-25 minutes

Utensils: Bowl with lid (2 litre capacity)

Shallow, square gratin dish with lid  
(approx. 20 x 20 x 6 cm)

### Ingredients

300 g canned tomatoes  
50 g ham, finely cubed  
1 onion (50 g), finely chopped  
1 clove of garlic, crushed  
250 g minced meat (beef)  
2 tbsp mashed tomato (30 g)  
salt & pepper, oregano, thyme & basil  
150 ml cream (crème fraîche)  
100 ml milk  
50 g grated Parmesan cheese  
1 tsp mixed chopped herbs  
1 tsp olive oil  
salt & pepper, nutmeg  
1 tsp vegetable to grease the dish  
125 g green flat pasta  
1 tbsp grated Parmesan cheese  
1 tbsp butter or margarine

## Tagliatelle with cream & basil sauce

2 portions

Total cooking time: approx. 16-22 minutes

Utensils: Bowl with lid (2 litre capacity)

Round soufflé dish (approx. 20 cm diam.)

### Ingredients

1 l water  
1 tsp salt  
200 g tagliatelle  
1 clove of garlic  
15-20 basil leaves  
200 g cream (crème fraîche)  
30 g grated Parmesan cheese  
salt & pepper

## Bread dumplings

5 portions

Total cooking time: approx. 8-11 minutes

Utensils: Bowl with lid (1 litre capacity)

5 cups or pudding moulds



### Ingredients

2 tbsp butter or margarine (20 g)  
1 onion (50 g), finely chopped  
500 ml milk  
200 g dried bread cubes  
(from approx. 5 bread rolls)  
3 eggs

1. Cut the tomatoes into slices, mix with the ham, onion cubes, garlic, minced meat and mashed tomato. Season and cook with the lid on.  
**5-8 min.**  **900 W**
2. Mix the cream with the milk, Parmesan cheese, herbs, oil and spices.
3. Grease the soufflé mould and cover the bottom of the mould with about 1/3 of the pasta. Put half of the minced meat mixture on the pasta and pour on some sauce. Put an additional 1/3 of the pasta on top followed by another layer of the minced meat mixture and some sauce, finishing with the remaining pasta on top. Finally, cover the pasta with lots of sauce and sprinkle with Parmesan cheese. Place butter flakes on top and cook with the lid on.

**13-17 min.**  **630 W**

After cooking, let the lasagne stand for approximately 5-10 minutes.

1. Place the water and the salt into the bowl, cover and bring to the boil.  
**9-11 min.**  **900 W**
2. Add the pasta, bring to the boil again, and then simmer.  
**1. 1-2 min.**  **900 W**  
**2. 6-9 min.**  **270 W**
3. Meanwhile rub the garlic cloves over the soufflé dish. Chop the basil leaves. Keep some aside for garnishing.
4. Drain the pasta well. Stir in the crème fraîche and sprinkle the basil over the pasta.
5. Add the parmesan cheese, salt and pepper, place into a soufflé dish and stir. Garnish the dish with basil and serve hot.

1. Cut the bread rolls into small cubes and soak in the milk.
2. Divide the fat on the bottom of the bowl and add the chopped onion. Cover and cook.  
**1-2 min.**  **900 W**
3. Add the onion to the bread cubes. Beat the eggs, add them and mix well to form a workable paste. If necessary add a little milk.
4. Divide the paste equally into 5 cups or pudding moulds, cover with microwave cling film, arrange on the edge of the turntable and cook.

**6-8 min.**  **900 W**

Allow the dumplings to stand for about 2 minutes after cooking. Turn the dumplings into a plate before serving.

# Recipes

## Berry jelly with vanilla sauce

Total cooking time: approx. 8-12 minutes

Utensils: Bowl with lid (2 litre capacity)

Ingredients

150 g	redcurrants, washed and sorted
150 g	strawberries, washed and sorted
150 g	raspberries, washed and sorted
250 ml	white wine
100 g	sugar
50 ml	lemon juice
8	gelatine sheets
300 ml	milk
	flavouring from 1/2 vanilla pod
30 g	sugar
15 g	cornflour

Tip: You can also use frozen fruit once it is defrosted.

## Pears in chocolate sauce

Total cooking time: approx. 8-13 minutes

Utensils: Bowl with lid (2 litre capacity)

Bowl with lid (1 litre capacity)

Ingredients

4	pears (600 g)
60 g	sugar
1 pack	vanilla sugar (10 g)
1 tbsp	pear liqueur, 30 % proof
150 ml	water
130 g	plain chocolate pieces
100 g	cream (crème fraîche)

## Fiery drink

for 30 servings

Total cooking time: approx. 8-10 minutes

Utensils: Bowl with lid (2 litre capacity)

Ingredients

500 ml	white wine
500 ml	dry red wine
500 ml	rum, 54 % proof
1	whole orange
3	cinnamon sticks
75 g	sugar
10 tsp	rock candy

1. Reserve some of the fruit for decoration. Puree the rest of the berries with the wine. Put into the bowl and cook cover.

**5-7 min.** ☑ **900 W**

Add sugar and lemon juice.

2. Leave gelatine in cold water for 10 minutes to soften. Remove and squeeze out water. Stir gelatine into the hot fruit until it dissolves. Put the jelly into the fridge to set.
  3. To make the vanilla sauce, put the milk in a bowl. Slice the vanilla pod open and scrape out the vanilla flavouring. Stir the flavouring, sugar and cornflour into the milk and cover before cooking. Stir occasionally during cooking and to finish.
- 3-5 min.** ☑ **900 W**
4. Tip the set jelly onto a plate and garnish with the whole berries. Serve with the vanilla sauce.

1. Peel the pears, keeping them whole.
  2. Put sugar, vanilla sugar, liqueur and water into the bowl. Stir and heat.
- 1-2 min.** ☑ **900 W**
3. Place the pears in the juice, cover and cook.
- 5-8 min.** ☑ **900 W**
- Take the pears out of the juice and allow to cool.
4. Put 50 ml of the juice in the small bowl, add the cream and chocolate. Cover and heat.
- 2-3 min.** ☑ **900 W**
5. Stir the sauce well and pour over the pears to serve.

Tip: You could also serve this with vanilla ice cream.

1. Pour the alcohol into the bowl. Peel the orange so that the peel is thin and put this in the alcohol together with the cinnamon and sugar. Cover and heat.
- 8-10 min.** ☑ **900 W**
2. Remove the peel and cinnamon. Put one teaspoon of the rock candy into each grog glass, top up with the fiery drink and serve.

# Recipes

## Cheesecake

12 portions

Total cooking time: approx. 21–27 minutes

Utensils: Round baking tin (approx. 26 cm diam.)

Ingredients

300 g flour  
1 tbsp cocoa  
3 tsp baking powder (9 g)  
150 g sugar  
1 egg  
150 g butter or margarine  
1 tsp butter or margarine to grease the dish  
100 g butter or margarine  
100 g sugar  
1 pack vanilla sugar (10 g)  
3 eggs  
400 g fromage frais, 20 % fat content  
1 pack powdered vanilla pudding mix (40 g)

1. Mix the flour and cocoa with the baking flour. Add the sugar, egg and butter and use the kneading hook on the hand-held blender to knead.
2. Grease the tin, roll out  $\frac{2}{3}$  of the dough and place it in the tin. Lift the edges 2 cm to form a rim. Pre-bake the pastry.

**6–8 min.**  **630 W**

3. For the filling, whisk the butter until light and fluffy, add the sugar and eggs one at a time. Finally add the fromage frais and the powdered vanilla pudding mix.
4. Spread the filling over the pre-baked dough and add the remaining crumbling dough on the cake and bake.

**15–19 min.**  **630 W**

## Semolina pudding with raspberry sauce

Total cooking time: approx. 15–20 minutes

Utensils: Bowl with lid (2 litre capacity)

Ingredients

500 ml milk  
40 g sugar  
15 g chopped almonds  
50 g semolina  
1 egg yolk  
1 tbsp water  
1 egg white  
250 g raspberries  
50 ml water  
40 g sugar

1. Put the milk, sugar and almonds into the bowl, cover and heat.

**3–5 min.**  **900 W**

2. Add the semolina and stir. Cover and microwave. Stir once during cooking.

**10–12 min.**  **270 W**

3. Mix the egg yolk with the water in a cup and fold into the hot semolina. Beat the egg white until stiff and lightly fold it in. Transfer the pudding to small bowls.
4. For the sauce wash the raspberries, dry carefully and put into a bowl with water and sugar. Cover and heat.

**2–3 min.**  **900 W**

5. Puree the raspberries and serve either hot or cold with the semolina pudding.

## Chocolate with cream

1 portion

Total cooking time: approx. 1 minute

Utensils: Large cup (200 ml capacity)

Ingredients

150 ml milk  
30 g plain chocolate, grated  
30 ml cream  
chocolate vermicelli

1. Pour the milk into the cup. Add the chocolate, stir and heat. Stir occasionally.

**approx. 1 min.**  **900 W**

2. Whip the cream until stiff and spoon this on top of the chocolate. Serve garnished with chocolate vermicelli.

# Care & cleaning

**CAUTION: DO NOT USE COMMERCIAL OVEN CLEANERS, STEAM CLEANERS, ABRASIVE, HARSH CLEANERS, ANY THAT CONTAIN SODIUM HYDROXIDE OR SCOURING PADS ON ANY PART OF YOUR MICROWAVE OVEN.**

**CLEAN THE OVEN AT REGULAR INTERVALS AND REMOVE ANY FOOD DEPOSITS. Failure to maintain the oven in a clean condition could lead to a deterioration of the surface that could adversely affect the life of the appliance and possibly result in a hazardous situation.**

## Oven exterior

The outside of your oven can be cleaned easily with mild soap and water. Make sure the soap is wiped off with a moist cloth, and dry the exterior with a soft towel.

## Control panel

Open the door before cleaning to de-activate the control panel. Care should be taken when cleaning the control panel. Using a cloth dampened with water only, gently wipe the panel until it becomes clean. Avoid using excessive amounts of water. Do not use any sort of chemical or abrasive cleaner.

## Oven Interior

1. For cleaning, wipe any splatters or spills with a soft damp cloth or sponge after each use while the oven is still warm. For heavier spills, use a mild soap and wipe several times with a damp cloth until all residues are removed. Do not remove the waveguide cover.
2. Make sure that mild soap or water does not penetrate the small vents in the walls which may cause damage to the oven.
3. Do not use spray type cleaners on the oven interior.
4. Heat up your oven regularly by using the grill, refer to note 2 on page 17. Remaining food or fat splashed can cause smoke or a bad smell.

## Turntable and turntable support

Remove the turntable and turntable support from the oven. Wash the turntable and turntable support in mild soapy water. Dry with a soft cloth. Both the turntable and the turntable support are dishwasher safe.

## Door

To remove all trace of dirt, regularly clean both sides of the door, the door seals and sealing surfaces with a soft, damp cloth.

## Racks

These should be washed in a mild washing up liquid solution and dried. The racks are dishwasher safe.

**NOTE:** A steam cleaner should not be used.

# What to do if...

## ... the microwave appliance is not working properly ?

Check that

- the fuses in the fuse box are working,
- there has not been a power outage.
- If the fuses continue to blow, please contact a qualified electrician.

## ... the microwave mode is not working ?

Check that

- the door is properly closed,
- the door seals and their surfaces are clean,
- the START/QUICK-button has been pressed

## ... the turntable is not turning ?

Check that

- the turntable support is correctly connected to the drive,
- the ovenware does not extend beyond the turntable,
- food does not extend beyond the edge of the turntable preventing it from rotating.
- there is nothing in the well beneath the turntable.

**NOTE:** If you cook the food over the standard time with only the same cooking mode, the power of the oven will lower automatically to avoid overheating. (The microwave power level will be reduced or the grill heating element will begin to light on and off). After pausing for 90 seconds, full power can be reset.

Cooking Mode	Standard time	Reduced power level
Microwave (900 W)	20 minutes	Microwave - 630 W
Grill	30 minutes	Grill - 50%
Dual Grill	Grill - 30 minutes	Grill - 50%

# Service & spare parts

If you wish to purchase spare parts or require an engineer, contact your local AEG-Electrolux Service Force Centre by telephoning:

**08705 929 929**

Your telephone call will be automatically routed to the Service Force Centre covering your post code area.

For the address of your local Service Force Centre and further information about Service Force, please visit the website at:

**[www.serviceforce.co.uk](http://www.serviceforce.co.uk)**

When you contact the Service Force Centre they will need the following information:

1. Your name & address, including post code.
2. Your telephone number
3. Clear and concise details of the fault.
4. The model and serial number of the appliance (found on the rating plate).
5. The purchase date:  
Please note that a valid purchase receipt or guarantee documentation is required for in-guarantee service calls.

## Customer care

For general enquiries concerning your AEG-Electrolux appliance or for further information on AEG-Electrolux products please contact our Customer Care Department by letter or telephone at the address below or visit our website at:

**[www.aeg.co.uk](http://www.aeg.co.uk)**

Customer Care Department  
Major Appliances  
Addington Way  
Luton  
Bedfordshire  
LU4 9QQ

Tel. 08705 350350 \*

(\*) Calls may be recorded for training purposes.

For Customer Service in Ireland please contact us at the address below:

AEG-Electrolux  
Electrolux Group (Irl) Ltd  
Long Mile Road  
Dublin 12  
Republic of Ireland

Tel: + 353 (0)1 4090754

Email: [service.eid@electrolux.ie](mailto:service.eid@electrolux.ie)

# Guarantee conditions

## Standard guarantee conditions

We, AEG-Electrolux, undertake that if within 12 months of the date of the purchase this AEG-Electrolux appliance or any part thereof is proved to be defective by reason only of faulty workmanship or materials, we will, at our discretion repair or replace the same FREE OF CHARGE for labour, materials or carriage on condition that:

- The appliance has been correctly installed and used only on the electricity or gas supply stated on the rating plate.
- The appliance has been used for normal domestic purposes only, and in accordance with the manufacturer's operating and maintenance instructions.
- The appliance has not been serviced, maintained, repaired, taken apart or tampered with by any person not authorised by us.
- All service work under this guarantee must be undertaken by a Service Force Centre. Any appliance or defective part replaced shall become the Company's property.
- This guarantee is in addition to your statutory and other legal rights.
- Home visits are made between 8.30am and 5.30pm Monday to Friday.  
Visits may be available outside these hours in which case a premium will be charged.

## Exclusions

This guarantee does not cover:

- Damage or calls resulting from transportation, improper use or neglect, the replacement of any light bulbs or removable parts of glass or plastic.
- Costs incurred for calls to put right an appliance which is improperly installed or calls to appliances outside the United Kingdom.
- Appliances found to be in use within a commercial environment, plus those which are subject to rental agreements.
- Products of AEG-Electrolux manufacture which are not marketed by AEG-Electrolux.

## European Guarantee

If you should move to another country within Europe then your guarantee moves with you to your new home subject to the following qualifications:

- The guarantee starts from the date you first purchased your product.
- The guarantee is for the same period and to the same extent for labour and parts as exists in the new country of use for this brand or range of products.
- This guarantee relates to you and cannot be transferred to another user.
- Your new home is within the European Community (EC) or European Free Trade Area.
- The product is installed and used in accordance with our instructions and is only used domestically, i.e. a normal household.
- The product is installed taking into account regulations in your new country.

Before you move please contact your nearest Customer Care centre, listed below, to give them details of your new home. They will then ensure that the local Service Organisation is aware of your move and able to look after you and your appliances.

France	Senlis	+33 (0) 3 44 62 29 29
Germany	Nürnberg	+49 (0) 800 234 7378
Italy	Pordenone	+39 (0) 800 117511
Sweden	Stockholm	+46 (0) 8 672 5360
UK	Slough	+44 (0) 1753 219899



# Specifications

AC Line Voltage	: 230-240 V, 50 Hz, single phase
Distribution line fuse/circuit breaker	: Minimum 16 A
AC Power required:	Microwave : 1.42 kW Grill : 1.00 kW Microwave/Grill : 2.4 kW
Output power:	Microwave : 900 W (IEC 60705) Grill : 1000 W
Microwave Frequency	: 2450 MHz * (Group 2 / Class B)
Outside Dimensions	: 592 mm (W) x 460 mm (H) x 437 mm (D)
Cavity Dimensions	: 342 mm (W) x 207 mm (H) x 368 mm (D) **
Oven Capacity	: 26 litres **
Turntable	: ø 325 mm, glass
Weight	: approx. 20 kg
Oven lamp	: 25 W/240 – 250 V

\* This Product fulfils the requirement of the European standard EN55011.  
In conformity with this standard, this product is classified as group 2 class B equipment.  
Group 2 means that the equipment intentionally generates radio-frequency energy in the form of electromagnetic radiation for the heat treatment of food.  
Class B equipment means that the equipment is suitable to be used in domestic establishments.

\*\* Internal capacity is calculated by measuring maximum width, depth and height.  
Actual capacity for holding food is less.



This oven complies with the requirements of Directives 89/336/EEC and 73/23/EEC as amended by 93/68/EEC.  
SPECIFICATIONS ARE SUBJECT TO CHANGE WITHOUT NOTICE AS PART OF CONTINUOUS IMPROVEMENT

## Important information



### Ecologically responsible disposal of packaging materials and old appliances



#### Packaging materials

AEG-Electrolux microwave ovens require effective packaging to protect them during transportation. Only the minimum packaging necessary is used.

Packaging materials (e.g. foil or styrofoam) can place children at risk.



**Danger of suffocation. Keep packaging material away from children.**



All packaging materials used are environment friendly and can be recycled. The cardboard is made from recycled paper and the wooden parts are untreated. Plastic items are marked as follows:

«PE» polyethylene eg packaging film

«PS» polystyrene eg packaging (CFC-free)

«PP» polypropylene eg packaging straps

By using and re-using the packaging, raw materials are saved and waste volume is reduced.

Packaging should be taken to your nearest recycling centre.

Contact your local council for information.



#### Disposal of old appliances

Old appliances should be made safe before disposal by removing the plug, and cutting off and disposing of the power cable.

It should then be taken to the nearest recycling centre. Check with your local Council or Environmental Health Office to see if there are facilities in your area for recycling the appliance.

# i Installation

## INSTALLING THE APPLIANCE

1. Remove all packaging and check carefully for any signs of damage.
2. If fitting the microwave oven above a conventional oven (position A) then use the mylar sheet provided.
  - a. Cut the Mylar sheet to fit the internal width of the unit.
  - b. Peel back the protective cover on the tape and fix to the rear of the shelf so that it covers the service gap. (See diagram).

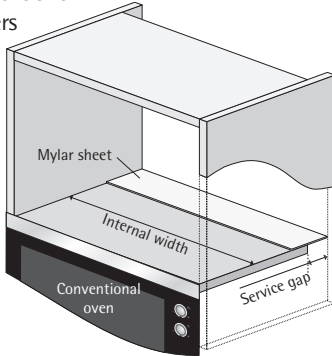

3. Fit the appliance into the kitchen cupboard slowly, and without force, until the front frame of the oven seals against the front opening of the cupboard.

4. Ensure the appliance is stable and not leaning. Ensure that a 5mm gap is kept between the cupboard door above and the top of the frame (see diagram).

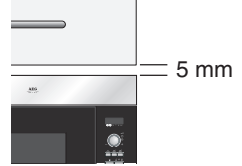

5. Fix the oven in position with the screws provided.

The fixing points are located on the top and bottom corners of the oven (see diagram, item 10, on page 5).

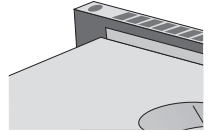

6. It is important to ensure that the installation of this product conforms to the instructions in this operation manual and the conventional oven manufacturer's installation instructions.

The microwave can be fitted in position A or B:

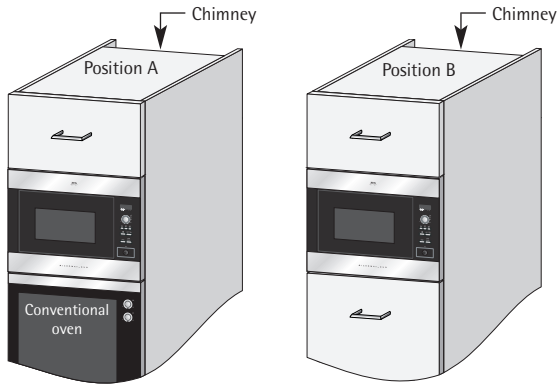

POSITION	NICHE SIZE			CHIMNEY (min)	Gap Between Cupboard & Ceiling
	W	D	H		
A	560	550	450	50	50
B	560	500	450	40	50

Measurements in (mm)

**NOTE:** Ensure the bottom of the oven is 85 cm or more above the floor.

# **i** Installation

## CONNECTING THE APPLIANCE TO THE POWER SUPPLY

- The electrical outlet should be readily accessible so that the unit can be unplugged easily in an emergency.
- The socket should not be positioned behind the cupboard.
- The best position is above the cupboard, see (A).

When not connecting the power supply cord to position (A) it should be removed from the support clip (see diagram, item 14, on page 5) and routed under the oven.

- Connect the appliance to a single phase 230–240 V/50 Hz alternating current via a correctly installed earth socket. The socket must be fused with a 16 A fuse.
- If the appliance is to be operated in a non-European country, the supply voltage, current type and frequency of the appliance indicated on the rating plate must correspond with the specification of your power supply. The rating plate can be found on the inside face of the control panel.
- The power supply cord may only be replaced by an electrician.
- Before installing, tie a piece of string to the power supply cord to facilitate connection to point (A) when the appliance is being installed.
- When inserting the appliance into the high-sided cupboard, DO NOT crush the power supply cord.

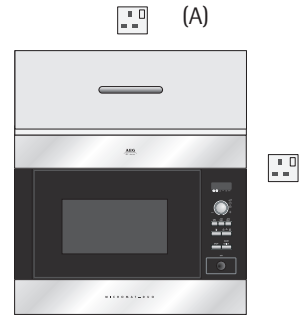

## ELECTRICAL CONNECTIONS



**WARNING:**  
**THIS APPLIANCE MUST BE EARTHED**  
The manufacturer declines any liability should this safety measure not be observed.

- If the plug that is fitted to your appliance is not suitable for your socket outlet, it must be cut off and the appropriate plug fitted.
- Remove the fuse from the cut off plug. The cut off plug should then be disposed of to prevent the hazard of shocks in case it should be plugged into a 13 Amp socket in another part of your home.

### IMPORTANT

The wires in the mains lead are coloured in accordance with the following code:

GREEN AND YELLOW	EARTH
BLUE	NEUTRAL
BROWN	LIVE

If you fit your own plug, the colours of the wires in the mains lead of your appliance may not correspond with the markings identifying the terminals in your plug, proceed as follows:

- Connect the green and yellow (earth) wire to the terminal in the plug which is marked with the letter "E" or the earth symbol (  ) or coloured green and yellow.
- Connect the blue (neutral) wire to the terminal in the plug which is marked with the letter "N" or coloured black.
- Connect the brown (live) wire to the terminal in the plug which is marked with the letter "L" or coloured red.

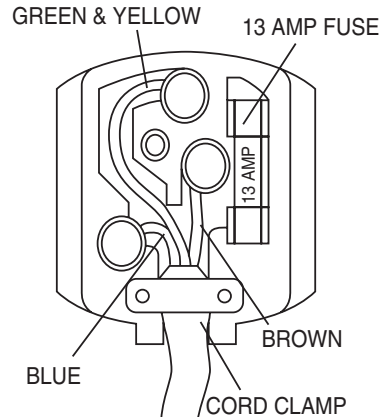



**From the Electrolux Group. The World's No.1 choice.**

*The Electrolux group is the world's largest producer of powered appliances for the kitchen, cleaning and outdoor use. More than 55 million Electrolux Group products (such as refrigerators, cookers, washing machines, vacuum cleaners, chain saws and lawn mowers) are sold each year to a value of approx. USD 14 billion in more than 150 countries around the world.*

Major Appliances  
Addington Way  
Luton  
Bedfordshire  
LU4 9QQ  
Telephone: 08705 350350  
© Electrolux plc 2005

TINS-A361URR1 

Printed on recycled paper-  
AEG-Electrolux - putting words into action

Printed on paper manufactured with  
environmentally sound processes.  
He who thinks ecologically acts accordingly ...