

Thinking of you
Electrolux

User Manual

Microwave oven

EMS17206



We were thinking of you
when we made this product

GB

Welcome to the world of Electrolux

You've chosen a first class product from Electrolux, which hopefully will provide you with lots of pleasure in the future. Electrolux ambition is to offer a wide variety of quality products that would make your life even more comfortable. You can look at some examples on the cover in this manual. But now it's time to study this manual and start using and enjoying the benefits from your new machine. We promise that it'll make your life a little easier. Good luck!

GB **Contents**

Safety information	5
Product description	9
Before first use	12
Operation	13
Programme charts	22
Recipes	28
Care & cleaning	32
Troubleshooting	33
Specification	34
Installation	35
Environmental information	39
Guarantee / Customer service	40



Important safety instructions: Read carefully & keep for future reference

To avoid the danger of fire

The microwave oven should not be left unattended during operation.

Power levels that are too high or cooking times that are too long may overheat foods resulting in a fire.

The electrical outlet must be readily accessible so that the unit can be unplugged easily in an emergency. Do not store or use the oven outdoors.

If food being heated begins to smoke, DO NOT OPEN THE DOOR. Turn off and unplug the oven and wait until the food has stopped smoking. Opening the door while food is smoking may cause a fire.

Only use microwave-safe containers and utensils. See page 16.

Do not leave the oven unattended when using disposable plastic, paper or other combustible food containers.

Clean the waveguide cover, the oven cavity, the turntable and turntable support after use. These must be dry and free from grease. Built-up grease may overheat and begin to smoke or catch fire.

Do not place flammable materials near the oven or ventilation openings. Do not block the ventilation openings.

Remove all metallic seals, wire twists, etc., from food and food packages. Arcing on metallic surfaces may cause a fire.

Do not use the microwave oven to heat oil for deep frying. The temperature cannot be controlled and the oil may catch fire.

To make popcorn, only use special microwave popcorn makers.

Do not store food or any other items inside the oven.

Check the settings after you start the oven to ensure the oven is operating as desired.

See the corresponding hints in this operation manual.

To avoid the possibility of injury



Warning: Do not operate the oven if it is damaged or malfunctioning. Check the following before use:

- a) **The door; make sure the door closes properly and ensure it is not misaligned or warped.**
- b) **The hinges and door safety latches; check to make sure they are not broken or loose.**
- c) **The door seals and sealing surfaces; ensure that they have not been damaged.**
- d) **Inside the oven cavity or on the door; make sure there are no dents.**
- e) **The power supply cord and plug; ensure that they are not damaged.**

Never adjust, repair or modify the oven yourself. It is hazardous for anyone other than a competent person to carry out any service or repair operation which involves the removal of a cover which gives protection against exposure to microwave energy.

Do not operate the oven with the door open or alter the door safety latches in any way.

Do not operate the oven if there is an object between the door seals and sealing surfaces.

Do not allow grease or dirt to build up on the door seals and adjacent parts. Follow instructions for “Care & cleaning”, page 32. Failure to maintain the oven in a clean condition could lead to a deterioration of the surface that could adversely affect the life of the appliance and possibly result in a hazardous situation.

Individuals with PACEMAKERS should check with their doctor or the manufacturer of the pacemaker for precautions regarding microwave ovens.

To avoid the possibility of electric shock

Under no circumstances should you remove the outer cabinet.

Never spill or insert any objects into the door lock openings or ventilation openings. In the event of a spill, turn off and unplug the oven immediately and call your local Service Force Centre.

Do not immerse the power supply cord or plug in water or any other liquid. Do not allow the power supply cord to run over any hot or sharp surfaces, such as the hot air vent area at the top rear of the oven.

Do not attempt to replace the oven lamp yourself or allow anyone who is not authorised by Service Force to do so. If the oven lamp fails, please consult your dealer or contact your local Service Force Centre.

If the power supply cord of this appliance is damaged, it must be replaced with a special cord. The exchange must be made by an authorised Service Force technician.

To avoid the possibility of explosion and sudden boiling



Warning: Liquids and other foods must not be heated in sealed containers since they are liable to explode.

Never use sealed containers. Remove seals and lids before use. Sealed containers can explode due to a build up of pressure even after the oven has been turned off.

Take care when microwaving liquids. Use a wide-mouthed container to allow bubbles to escape.

Microwave heating of beverages can result in delayed eruptive boiling, therefore care has to be taken when handling the container.

To prevent sudden eruption of boiling liquid and possible scalding:

1. Stir liquid prior to heating/reheating.
2. It is advisable to insert a glass rod or similar utensil into the liquid whilst reheating.
3. Let liquid stand for at least 20 seconds in the oven at the end of cooking time to prevent delayed eruptive boiling.

Do not cook eggs in their shells and whole hard boiled eggs should not be heated in microwave ovens since they may explode even after microwave cooking has ended. To cook or reheat eggs which have not been scrambled or mixed, pierce the yolks and the whites, or the eggs may explode. Shell and slice hard boiled eggs before reheating them in the microwave oven.

Pierce the skin of such foods as potatoes, sausages and fruit before cooking, or they may explode.

To avoid the possibility of burns

Use pot holders or oven gloves when removing food from the oven to prevent burns.

Always open containers, popcorn makers, oven cooking bags, etc., away from the face and hands to avoid steam burns.

To avoid burns, always test food temperature and stir before serving and pay special attention to the temperature of food and drink given to babies, children or the elderly.

Temperature of the container is not a true indication of the temperature of the food or drink; always check the food temperature.

Always stand back from the oven door when opening to avoid burns from escaping steam and heat.

Slice stuffed baked foods after heating to release steam and avoid burns.

Keep children away from the door to prevent them burning themselves.

To avoid misuse by children

Warning: Only allow children to use the oven without supervision when adequate instructions have been given so that the child is able to use the oven in a safe way and understands the hazards of improper use.

Do not lean or swing on the oven door. Do not play with the oven or use it as a toy.

Children should be taught all important safety instructions: use of pot holders, careful removal of food coverings; paying special attention to packaging (e.g. self-heating materials) designed to make food crisp, as they may be extra hot.

Other warnings

Never modify the oven in any way. This oven is for home food preparation only and may only be used for cooking food. It is not suitable for commercial or laboratory use.

To promote trouble-free use of your oven and avoid damage

Never operate the oven when it is empty.

When using a browning dish or self-heating material, always place a heat-resistant insulator such as a porcelain plate under it to prevent damage to the turntable and turntable support due to heat stress. The preheating time specified in the dish's instructions must not be exceeded.

Do not use metal utensils, which reflect microwaves and may cause electrical arcing. Do not put cans in the oven.

Only use the turntable and the turntable support designed for this oven. Do not operate the oven without the turntable.

To prevent the turntable from breaking:

- a) Before cleaning the turntable with water, leave the turntable to cool.
- b) Do not put hot foods or hot utensils on a cold turntable.
- c) Do not put cold foods or cold utensils on a hot turntable.

Do not place anything on the outer cabinet during operation.

Note:

If you are unsure how to connect your oven, please consult an authorised, qualified electrician.

Neither the manufacturer nor the dealer can accept any liability for damage to the oven or personal injury resulting from failure to observe the correct electrical connection procedure.

Water vapour or drops may occasionally form on the oven walls or around the door seals and sealing surfaces. This is a normal occurrence and is not an indication of microwave leakage or a malfunction.

Product description

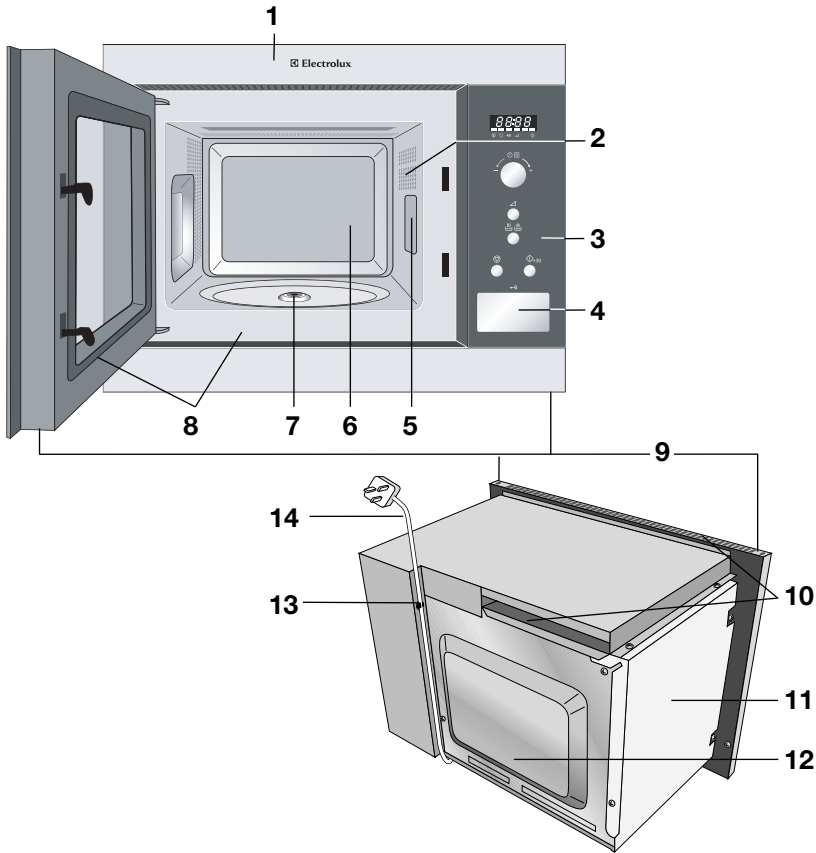

- | | |
|------------------------------|--|
| 1 Front trim | 8 Door seals and sealing surfaces |
| 2 Oven lamp | 9 Fixing points (4 points) |
| 3 Control panel | 10 Ventilation openings |
| 4 Door opening button | 11 Outer cover |
| 5 Waveguide cover | 12 Rear cabinet |
| 6 Oven cavity | 13 Power supply cord support clip |
| 7 Seal packing | 14 Power supply cord |

Control panel

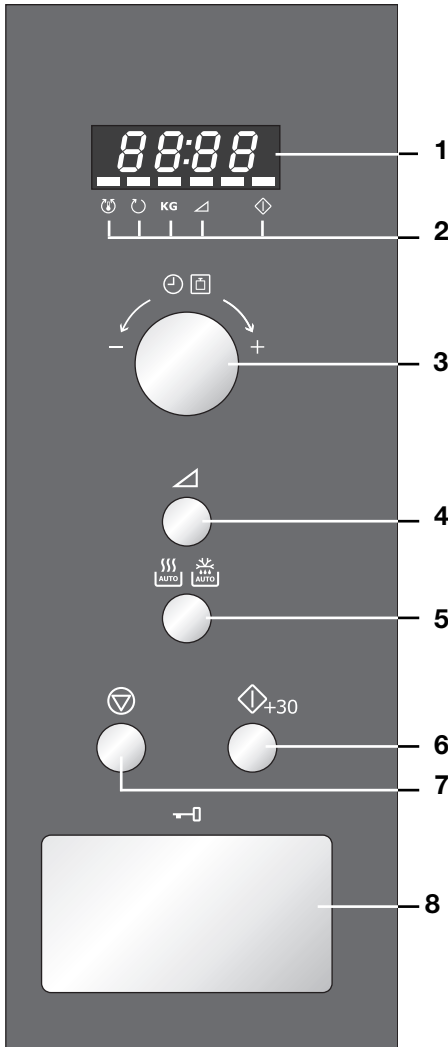

1 Digital display

2 Indicators

The appropriate indicator will flash or light up, just above each symbol according to the instruction. When an indicator is flashing, press the appropriate button (having the same symbol) or carry out the necessary operation.

- ☞ Stir
- ↻ Turn over
- KG Weight
- ▲ Microwave power level
- ◇ Cooking in progress

3 TIMER/WEIGHT knob

4 MICROWAVE POWER LEVEL button

5 AUTO PROGRAMMES button

Press to select one of the 12 automatic programmes.

6 START/+30 button

7 STOP button

8 DOOR OPENING button

Accessories

Check to make sure the following accessories are provided:

(15) Turntable

(16) Turntable support

(17) 4 fixing screws (not shown)

- Place the turntable support in the seal packing on the floor of the cavity.
- Then place the turntable on the turntable support.
- To avoid turntable damage, ensure dishes or containers are lifted clear of the turntable rim when removing them from the oven.

Note: When you order accessories, please mention two items: part name and model name to your dealer or local Service Force Centre.

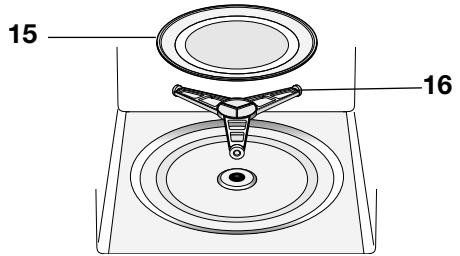

Before first use

Before operation

1. Plug in the oven.
2. The oven display will flash:

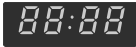

3. Press the **STOP** button, the display will show:



4. To set the clock, see below.

Using the STOP button

Use the **STOP** button to:

1. Erase a mistake during programming.
2. Stop the oven temporarily during cooking.
3. Cancel a programme during cooking, touch twice.

Setting the clock

There are two setting modes: 12 hour clock and 24 hour clock.

1. To set the 12 hour clock, hold the **MICROWAVE POWER LEVEL** button down for 3 seconds. **12 H** will appear in the display.
2. To set the 24 hour clock, press the **MICROWAVE POWER LEVEL** button once more after Step 1, **24 H** will appear in the display.

Example: To set the 24 hour clock to 23:35.

1. Choose the clock function. (12 hour clock).



x1 and hold for 3 seconds

Choose the 24 hour clock.



2. Set the hours. Rotate the **TIMER/WEIGHT** knob until the correct hour is displayed (23).

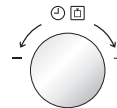

3. Press the **MICROWAVE POWER LEVEL** button to change from hours to minutes.



4. Set the minutes. Rotate the **TIMER/WEIGHT** knob until the correct minute is displayed (35).

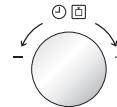

5. Press the **MICROWAVE POWER LEVEL** button to start the clock.



Notes:

1. You can rotate the **TIMER/WEIGHT** knob clockwise or counter-clockwise.
2. Press the **STOP** button if you make a mistake during programming.
3. If the electrical power supply to your microwave oven is interrupted, the display will intermittently show **88:88** after the power is reinstated. If this occurs during cooking, the programme will be erased. The time of day will also be erased.
4. When you want to reset the time of day, follow the example on page 12 again.

Microwave cooking advice

Microwaves are energy waves, similar to those used for TV and radio signals.

Electrical energy is converted into microwave energy, which is directed into the oven cavity via a waveguide. To prevent food and grease entering the waveguide it is protected by the waveguide cover.

Microwaves cannot pass through metal, because of this the oven cavity is made of metal and there is a fine metal mesh on the door. During cooking the microwaves bounce off the sides of the oven cavity at random.

Microwaves will pass through certain materials, such as glass and plastic, to heat the food. (See 'Suitable Cookware' on page 16).

To cook/defrost food in a microwave oven, the microwave energy must be able to pass through the container to penetrate the food. Therefore it is important to choose suitable cookware.

Round/oval dishes are preferable to square/oblong ones, as the food in the corners tends to overcook. A variety of cookware can be used as listed on page 16.

Water, sugar and fat in food absorb microwaves which cause them to vibrate. This creates heat by friction, in the same way your hands get warm when you rub them together.

The outer areas of the food are heated by the microwave energy, then the heat moves to the centre by conduction, as it does in conventional cooking. It is important to turn, rearrange or stir food to ensure even heating.

Once cooking is complete, the oven automatically stops producing microwaves.

Standing time is necessary after cooking, as it enables the heat to disperse equally throughout the food.

Microwaves cook food faster than conventional cooking. It is therefore essential that certain techniques are followed to ensure good results. Many of the following techniques are similar to those used in conventional cooking.

Food characteristics

Composition	Foods high in fat or sugar (e.g. Christmas pudding, mince pies) require less heating time. Care should be taken as overheating can lead to fire.
Density	Food density will affect the amount of cooking time needed. Light porous foods, such as cakes or bread, cook more quickly than heavy, dense foods, such as roasts and casseroles.
Quantity	The cooking time must be increased as the amount of food placed in the oven increases. E.g. four potatoes will take longer to cook than two.
Size	Small foods and small pieces cook faster than large ones, as microwaves can penetrate from all sides to the centre. For even cooking make all the pieces the same size.
Shape	Foods which are irregular in shape, such as chicken breasts or drumsticks, take longer to cook in the thicker parts. Round shapes cook more evenly than square shapes when microwave cooking.
Temperature of food	The initial temperature of food affects the amount of cooking time needed. Chilled foods will take longer to cook than food at room temperature. Cut into foods with fillings, for example jam doughnuts, to release heat or steam.

Cooking techniques

Arrange	Place the thickest parts of food towards the outside of the dish. e.g. Chicken drumsticks.
Cover	Use vented microwave cling film or a suitable lid.
Pierce	Foods with a shell, skin or membrane must be pierced in several places before cooking or reheating as steam will build up and may cause food to explode. E.g. Potatoes, Fish, Chicken, Sausages. Note: <i>Eggs should not be heated using microwave power as they may explode, even after cooking has ended. E.g. poached, fried, hard boiled.</i>
Stir, turn & rearrange	For even cooking it is essential to stir, turn and rearrange food during cooking. Always stir and rearrange from the outside towards the centre.
Stand	Standing time is necessary after cooking to enable the heat to disperse equally throughout the food.
Shield	Some areas of food being defrosted may become warm. Warm areas can be shielded with small pieces of foil, which reflect microwaves, e.g. legs and wings on a chicken.

Browning agents

After more than 15 minutes cooking time food acquires a brownness, although this is not comparable to the deep brownness and crispness obtained through conventional cooking. In order to obtain an appetising brown colour you can use browning agents. For the most part they simultaneously act as seasoning agents. In the following table you will find some suggestions for substances you might use for browning and some of the uses to which you might put them.

Browning agent	Dish	Method
Melted butter & dried paprika	Poultry	Coat the poultry with the butter/paprika mixture
Dried paprika	Oven baked dishes - Cheese toasties	Dust with paprika
Soya sauce	Meat and poultry	Coat with the sauce
Barbecue & Worcestershire sauce, gravy	Roasts, rissoles, Small roasted items	Coat with the sauce
Rendered down bacon fat or dried onions	Oven baked dishes, toasted items, soups, stews	Sprinkle pieces of bacon or dried onions on top
Cocoa, chocolate flakes, brown icing, honey & marmalade	Cakes & desserts	Sprinkle pieces on top of cakes and desserts or use to glaze

Using a food thermometer to determine cooking times

Once cooked, every drink and every foodstuff has a certain internal temperature at which the cooking process can be switched off and the food will be cooked. The internal temperature can be ascertained with a food thermometer. The most important temperatures are specified in the temperature table.

Drink / food	Internal temp. at the end of cooking time	Internal temp. after 10 -15 mins standing time
Heating drinks (Coffee, Water, Tea, etc.)	65-75°C	
Heating milk	60-65°C	
Heating soup	75-80°C	
Heating stew	75-80°C	
Poultry	80-85°C	85-90°C
Lamb	Rare 70°C Well done 75-80°C	70-75°C 80-85°C
Roast beef	Rare 50-55°C Medium 60-65°C Well done 75-80°C	55-60°C 65-70°C 80-85°C
Pork, Veal	80-85°C	80-85°C

Cookware	Microwave safe	Comments
Aluminium Foil/ Foil Containers	✓ / ✗	Small pieces of aluminium foil can be used to shield food from overheating. Keep foil at least 2 cm from the oven walls, as arcing may occur. Foil containers are not recommended unless specified by the manufacturer, e.g. Microfoil ®, follow instructions carefully.
Browning Dishes	✓	Always follow the manufacturers instructions. Do not exceed heating times given. Be very careful as these dishes become very hot.
China & Ceramics	✓ / ✗	Porcelain, pottery, glazed earthenware and bone china are usually suitable, except for those with metallic decoration.
Glassware e.g. Pyrex ®	✓	Care should be taken if using fine glassware as it can break or crack if heated suddenly.
Metal	✗	It is not recommended to use metal cookware when using microwave power as it will arc, which can lead to fire.
Plastic/Polystyrene e.g. fast food containers	✓	Care must be taken as some containers warp, melt or discolour at high temperatures.
Cling film	✓	Should not touch the food and must be pierced to let the steam escape.
Freezer/ Roasting bags	✓	Must be pierced to let steam escape. Ensure bags are suitable for microwave use. Do not use plastic or metal ties, as they may melt or catch fire due to the metal arcing.
Paper - plates cups & kitchen paper	✓	Only use for warming or to absorb moisture. Care must be taken as overheating may cause fire.
Straw & wooden containers	✓	Always attend the oven when using these materials as overheating may cause fire.
Recycled paper & newspaper	✗	May contain extracts of metal which will cause 'arcing' and may lead to fire.

Microwave power levels

Your oven has 5 power levels. To choose the power level for cooking, follow the advice given in the recipe section. Generally the following recommendations apply:

Power setting	Suggested use
800 W	used for fast cooking or reheating, e.g. soup, casseroles, canned food, hot beverages, vegetables, fish, etc.
560 W	used for longer cooking of dense foods such as roast joints, meat loaf and plated meals, also for sensitive dishes such as cheese sauce and sponge cakes. At this reduced setting, the sauce will not boil over and food will cook evenly without over cooking at the sides.
400 W	for dense foods which require a long cooking time when cooked conventionally, e.g. beef dishes, it is advisable to use this power setting to ensure the meat will be tender.
240 W	(Defrost setting) to defrost, select this power setting, to ensure that the dish defrosts evenly. This setting is also ideal for simmering rice, pasta, dumplings and cooking egg custard.
80 W	for gentle defrosting, e.g. cream gateaux or pastry.

W = Watt

Note: To set the microwave power level, touch the **MICROWAVE POWER LEVEL** button until the desired level is displayed. If **MICROWAVE POWER LEVEL** button is touched once,  will be

displayed. If you miss your desired level, continue touching the **MICROWAVE POWER LEVEL** button until you reach the level again. If the level is not selected, the level 800 W is automatically set.

Manual operation

Your oven can be programmed for up to 90 minutes (90.00). The input unit of cooking (defrosting) time varies from 10 seconds to five minutes. It depends on the total length of the cooking (defrosting) time as shown in the table.

Cooking time	Increasing unit
0-5 minutes	10 seconds
5-10 minutes	30 seconds
10-30 minutes	1 minute
30-90 minutes	5 minutes

Example: Suppose you want to heat soup for 2 minutes and 30 seconds on 560 W microwave power.

1. Enter the desired cooking time by rotating the **TIMER/WEIGHT** knob clockwise.

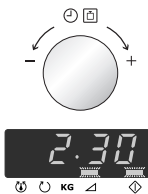

2. Choose the desired power level by pressing the **MICROWAVE POWER LEVEL** button twice.

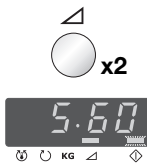

3. Press the **START/+30** button once to begin cooking.



Check the display.



Notes:

1. When the door is opened during the cooking process, the cooking time on the digital display stops automatically. The cooking time starts to count down again when the door is closed and the **START/+30** button is pressed.
2. If you wish to know the power level during cooking, press the **MICROWAVE POWER LEVEL** button. As long as your finger is touching the **MICROWAVE POWER LEVEL** button, the power level will be displayed.
3. You can rotate the **TIMER/WEIGHT** knob clockwise or counter-clockwise. If you rotate the knob counter-clockwise, the cooking time will decrease from 90 minutes by degrees.

Other convenient functions

1. Multiple sequence cooking

A maximum of 3 sequences can be input, consisting of manual cooking time and mode.

Example:

To cook: 5 minutes on 800 W
(Stage 1)
16 minutes on 240 W
(Stage 2)

Stage 1

1. Enter the desired cooking time by rotating the **TIMER/WEIGHT** knob.



2. Choose the desired power level by pressing the **MICROWAVE POWER LEVEL** button once.

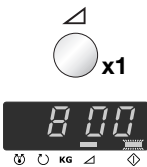

Stage 2

3. Enter the desired cooking time by rotating the **TIMER/WEIGHT** knob.

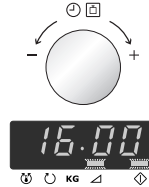

4. Choose the desired power level by pressing the **MICROWAVE POWER LEVEL** button four times.

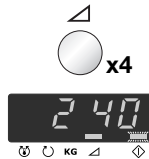

5. Press the **START/+30** button once to begin cooking.

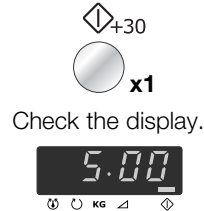

Check the display.

(The oven will begin to cook for 5 minutes on 800 W, and then for 16 minutes on 240 W.)

2. Add 30 seconds function

The **START/+30** button allows you to operate the two following functions:

a. Direct start

You can directly start cooking on 800 W microwave power level for 30 seconds by pressing the **START/+30** button.



Note: To avoid the misuse by children the **START/+30** button can be used only within 3 minutes after the preceding operation, i.e. closing the door, pressing the **STOP** button or cooking completion.

b. Extend the cooking time

You can extend the cooking time during manual cooking for multiples of 30 seconds if the button is pressed while the oven is in operation.

3. To check the power level

To check the microwave power level during cooking press the **MICROWAVE POWER LEVEL** button.



As long as your finger is touching the **MICROWAVE POWER LEVEL** button the power level will be displayed. The oven continues to count down although the display shows the power level.

4. Safety lock function

To set the safety lock function

1. Press and hold the **STOP** key for 3 seconds.

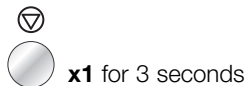

The display will show:



To cancel the safety lock function

1. Press and hold the **STOP** key for 3 seconds.

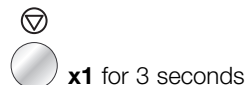

The display will show the time of day, if set.

Note: When the Safety Lock is set you cannot input any buttons except the **STOP** button.

Auto programmes operation

The **AUTO PROGRAMMES** function automatically works out the correct cooking mode and cooking time. You can choose from 7 **AUTO COOK** menus and 5 **AUTO DEFROST** menus. What you need to know when using this automatic function:

1. Press the **AUTO PROGRAMMES** button once. The menu can be chosen by pressing the **AUTO PROGRAMMES** button until the desired menu number is displayed. See pages 22-24 “**AUTO PROGRAMMES** charts”. To select a defrost menu, press the **AUTO PROGRAMMES** button at least 8 times. If you press the button 8 times, **Ad - 1** will appear in the display. The menu will be changed automatically by holding down the **AUTO PROGRAMMES** button.
2. The weight or quantity of the food can be input by rotating the **TIMER/WEIGHT** knob until the desired weight is displayed.
 - Enter the weight of the food only. Do not include the weight of the container.
 - For food weighing more or less than weights given in the automatic chart, use manual programmes. For best results, follow the cooking charts on pages 26-28.
3. To start cooking press **START/+30** button. When action is required (e.g. to turn food over), the oven stops and the audible signals sound, the remaining cooking time and any indicator will flash on the display. To continue cooking, press the **START/+30** button.

The final temperature will vary according to the initial temperature. Check food is piping hot after cooking. If necessary, you can extend the cooking time and change the power level.

Example:

To cook Gratin weighing 1,0 kg using **AUTO COOK (AC-7)**.

1. Select the menu required by pressing the **AUTO PROGRAMMES** button seven times.

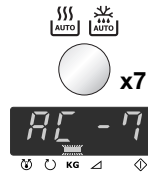

2. Enter the weight by rotating the **TIMER/WEIGHT** knob clockwise.

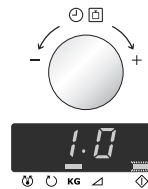

3. Press the **START/+30** button.

















Check the display.







Programme charts







Auto programmes chart

Button	Autocook No.	Weight (increasing weight) / utensils	Procedure
 x1	AC-1 Cook Frozen Vegetables e.g. Brussel sprouts, green beans, peas, mixed vegetables, broccoli 	0,1 - 0,6 kg (100 g) (initial temp -18°C) Bowl and lid	<ul style="list-style-type: none"> • Add 1 tbsp water per 100 g and salt as desired. (For mushrooms no additional water is necessary.) • Cover with a lid. • When the audible signal sounds, stir and re-cover. • After cooking, let stand for approx. 2 min. <p>Note: <i>If frozen vegetables are compacted together, cook manually.</i></p>
 x2	AC-2 Cook Fresh Vegetables 	0,1 - 0,6 kg (100 g) (initial temp 20°C) Bowl and lid	<ul style="list-style-type: none"> • Cut into small pieces, eg. strips, cubes or slices. • Add 1 tbsp water per 100 g and salt as desired. (For mushrooms no additional water is necessary.) • Cover with a lid. • When the audible signal sounds, stir and re-cover. • After cooking, stand for approx. 2 min.
 x3	AC-3 Cook Frozen Ready Meals Stirrable type e.g. Noodles, Bolognese, Chinese Menus. 	0,3 - 1,0 kg* (100 g) (initial temp -18°C) Bowl and lid * If the manufacturer instructs to add water, calculate the total amount for the programmes with additional liquid.	<ul style="list-style-type: none"> • Transfer meal to suitable microwave-proof dish. • Add some liquid if recommended by the manufacturer. • Cover with a lid. • Cook without cover if the manufacturer instructs. • When audible signal sounds, stir and re-cover. • After cooking, stir and stand for approx. 2 min.
 x4	AC-4 Cook Frozen Gratin e.g. macaroni gratin, lasagne, etc. 	0,2 - 0,6 kg (100 g) (initial temp -18°C) Shallow, oval gratin dish and microwave cling film or original container and microwave cling film	<ul style="list-style-type: none"> • Remove the frozen gratin from the package. If the container is not suitable for microwave ovens, transfer gratin to a suitable microwave proof dish. • Cover with microwave cling film. • If the container is suitable for microwave ovens, remove original paper cover and cover with microwave cling film. • After cooking, stand for approx. 5 min.

Button	Autocook No.	Weight (increasing weight) / utensils	Procedure
 x5	AC-5 Cook Boiled Potatoes Jacket Potatoes 	0,1 - 0,8 kg (100 g) (initial temp 20°C) Bowl & lid	Boiled Potatoes: Peel the potatoes and cut them into similar sized pieces. Jacket Potatoes: Choose potatoes of similar size and wash them. <ul style="list-style-type: none"> • Put the boiled or jacket potatoes into a bowl. • Add the required amount of water (per 100 g), approx. 2 tbsp and a little salt. • Cover with a lid. • When the audible signal sounds, stir and re-cover. • After cooking, let the potatoes stand for approx. 2 min.
 x6	AC-6 Cook Fish fillet with sauce 	0,4 - 1,2 kg* (100 g) (initial temp fish 5°C, sauce 20°C) Gratin dish & microwave cling film	<ul style="list-style-type: none"> • See recipes for "Fish Fillet with Sauce" on page 25. * Total weight of all ingredients.
 x7	AC-7 Cook Gratin 	0,5 - 1,5 kg* (100 g) (initial temp 20°C) Gratin dish	<ul style="list-style-type: none"> • See recipes for "Gratin" on pages 25 - 26. * Total weight of all ingredients.

Auto defrost chart

Button	Auto defrost No.	Weight (increasing weight) / utensils	Procedure
 x8	Ad-1 Defrost Steak and Chops 	0,2 - 0,8 kg (100 g) (initial temp -18°C) Flan dish (See note on page 24.)	<ul style="list-style-type: none"> • Place the food in a flan dish in the centre of the turntable. • When the audible signal sounds, turn the food over, rearrange and separate. Shield thin parts and warm spots with small pieces of aluminium foil. • After defrosting, wrap in aluminium foil for 10 - 15 min, until thoroughly defrosted.
 x9	Ad-2 Defrost Minced Meat 	0,2 - 0,8 kg (100 g) (initial temp -18°C) Flan dish (See note on page 24.)	<ul style="list-style-type: none"> • Place the block of minced meat in a flan dish in the centre of the turntable. • When the audible signal sounds, turn the food over. Remove the defrosted parts if possible. • After defrosting cover with aluminium foil, stand for 5 - 10 min, until thoroughly defrosted.

Button	Auto defrost No.	Weight (increasing weight) / utensils	Procedure
  x10	Ad-3 Defrost Poultry	0,9 - 1,5 kg (100 g) (initial temp -18°C) Flan dish (See note below.)	<ul style="list-style-type: none"> Place the poultry in a flan dish in the centre of the turntable. When the audible signal sounds, turn over and shield thin parts and warm spots with small pieces of aluminium foil. After defrosting, rinse with cold water, cover with aluminium foil and stand for 15 - 30 min, until thoroughly defrosted. Finally clean the poultry under running water.
  x11	Ad-4 Defrost Cake	0,1 - 1,4 kg (100 g) (initial temp -18°C) Plate	<ul style="list-style-type: none"> Remove all packaging from the cake. Place directly on the turntable, or on a plate in the middle of the turntable. After defrosting, cut the cake into similar sized pieces keeping space between each piece and stand for 10 - 30 min, until evenly defrosted.
  x12	Ad-5 Defrost Bread	0,1 - 1,0 kg (100 g) (initial temp -18°C) Flan dish (Only sliced bread is recommended for this programme.)	<ul style="list-style-type: none"> Distribute in a flan dish in the centre of the turntable. For 1,0 kg distribute directly on the turntable. When the audible signal sounds, turn over, re-arrange and remove defrosted slices. After defrosting cover with aluminum foil and stand for 5 - 15 min, until thoroughly defrosted.

Note: *Auto Defrost*

- Steaks and Chops should be frozen in one layer.
- Minced meat should be frozen in a thin shape.
- After turning over, shield the defrosted portions with small, flat pieces of aluminium foil.
- The poultry should be processed immediately after defrosting.
- Gateaux topped and coated with cream are very sensitive to microwave energy. For the best result, if the cream begins to soften rapidly, remove it from the oven immediately and stand for 10 - 30 minutes at room temperature.

Recipes for auto programmes AC-6 & AC-7

Fish fillet with sauce (AC-6) Fish fillet with piquant sauce

0,4 kg	0,8 kg	1,2 kg	
140 g	280 g	420 g	canned tomatoes (drained)
40 g	80 g	120 g	corn
4 g	8 g	12 g	chilli sauce
12 g	24 g	36 g	onion (finely chopped)
1 tsp	1-2 tsp	2 tsp	red wine vinegar
			mustard, thyme, cayenne pepper
200 g	400 g	600 g	fish fillet
			salt

Fish fillet with sauce (AC-6) Fish fillet with curry sauce

0,4 kg	0,8 kg	1,2 kg	
200 g	400 g	600 g	fish fillet
			salt
40 g	80 g	120 g	banana (sliced)
160 g	320 g	480 g	ready-made curry sauce

Gratin (AC-7) Spinach gratin

0,5 kg	1,0 kg	1,5 kg	
5 g	10 g	15 g	butter or margarine (to grease the dish)
150 g	300 g	450 g	leaf spinach (defrosted, drained)
15 g	30 g	45 g	onion (finely chopped)
			salt, pepper & nutmeg
150 g	300 g	450 g	boiled potatoes (sliced)
35 g	75 g	110 g	cooked ham (diced)
50 g	100 g	150 g	crème fraiche
1	2	3	eggs
40 g	75 g	115 g	grated cheese
			paprika powder

Preparation

1. Mix ingredients for the sauce.
2. Place the fish fillet in a round gratin dish with the thin ends toward the centre and sprinkle with salt.
3. Spread the sauce on the fish fillet.
4. Cover with microwave cling film and cook on **AUTO COOK (AC-6)**, "Fish Fillet with Sauce".
5. After cooking, stand for approx. 2 min.

Preparation

1. Place the fish fillet in a round gratin dish with the thin ends toward the centre and sprinkle with salt.
2. Spread the banana and the ready-made curry sauce over the fish fillet.
3. Cover with microwave cling film and cook on **AUTO COOK (AC-6)**, "Fish Fillet with Sauce".
4. After cooking, stand for approx. 2 min.

Preparation

1. Mix together the leaf spinach with the onion and season with salt, pepper and nutmeg.
2. Grease the gratin dish. Place alternate layers of potato slices, diced ham and spinach in the dish. The top layer should be spinach.
3. Mix the eggs with crème fraiche, add salt and pepper and pour over the gratin.
4. Cover the gratin with the grated cheese, sprinkle with paprika powder and cook on **AUTO COOK (AC-7)**, "Gratin".
5. After cooking, stand for 5-10 min.

Gratin (AC-7)**Potato-courgette-gratin**

0,5 kg	1,0 kg	1,5 kg	
200 g	400 g	600 g	boiled potatoes (sliced)
115 g	230 g	345 g	courgette (finely sliced)
75 g	150 g	225 g	crème fraiche
1	2	3	eggs
1/2	1	2	clove of garlic (crushed)
			salt, pepper
40 g	80 g	120 g	feta cheese (diced)
10 g	20 g	30 g	sunflower kernel paprika powder

Preparation

1. Grease the gratin dish and place alternate layers of potato slices and courgette in the dish.
2. Mix the eggs with crème fraiche, season with salt, pepper and garlic and pour over the gratin.
3. Crumble the feta cheese and sprinkle over the gratin.
4. Finally sprinkle the gratin with sunflower kernels and paprika powder and cook on **AUTO COOK (AC-7)**, "Gratin".
5. After cooking, stand for 5-10 min.

Cooking charts**Abbreviations used**

tblsp =
tablespoon

tsp = teaspoon
Cup = cupful

kg = kilogram
g = gram

l = litre
ml = millilitre

cm = centimetre
min = minutes

Heating food & drink

Food/drink	Quantity	Power	Time	Method	
	-g/ml-	-Setting-	-Min-		
Coffee	1 cup	150	800 W	approx. 1	do not cover
Milk	1 cup	150	800 W	approx. 1	do not cover
Water	1 cup	150	800 W	1 1/2 -2	do not cover
	6 cups	900	800 W	10-12	do not cover
	1 dish	1000	800 W	1 1/2 -13	do not cover
Platters (vegetables, meat & trimmings)	400	800 W	3-6	sprinkle some water onto the sauce, cover, stir halfway through heating time	
Soup / Stew	200	800 W	1 1/2 -2 1/2	cover, stir after heating	
Vegetables	200	800 W	2-2 1/2	if necessary add some water, cover, stir halfway through the heating time	
	500	800 W	4-5		
Meat, 1 slice *	200	800 W	3-4	thinly spread sauce over the top, cover	
Fish fillet *	200	800 W	2-3	cover	
Cake, 1 slice	100	400 W	1/2	place in a flan dish	
Baby food, 1 jar	190	400 W	approx. 1	transfer into a suitable microwavable container, after heating stir well and test the temperature	
Melting Margarine or Butter *	50	800 W	1/2	cover	
Melting chocolate	100	400 W	2-3	stir from time to time	

* from chilled

Food	Quantity -g-	Defrosting & cooking				Standing time -Min-
		Power -Setting-	Time -Min-	Added water -tbsps-	Hints	
Fish fillet	300	800 W	10-12	-	cover	1-2
One plate meal	400	800 W	9-11	-	cover, stir after 6 minutes	2
Broccoli	300	800 W	7-9	3-5	cover, stir halfway through cooking	2
Peas	300	800 W	7-9	3-5	cover, stir halfway through cooking	2
Mixed vegetables	500	800 W	11-13	3-5	cover, stir halfway through cooking	2

Food	Quantity -g-	Power Setting-	Defrosting		Hints	Standing time -Min-
			Time -Min-			
Roast meat (e.g. pork, beef, lamb, veal)	1500 1000 500	80 W 80 W 80 W	58-64 42-48 19-23		place in a flan dish, turn halfway through defrosting	30-90 30-90 30-90
Goulash	500	240 W	8-12		stir halfway through defrosting	10-15
Sausages, 8 pieces	600	240 W	6-9		place next to each other, turn	5-10
4 pieces	300	240 W	4-5		halfway through defrosting	5-10
Chicken legs	200	240 W	4-5		turn halfway through defrosting	10-15
Fish fillet	400	240 W	7-10		turn halfway through defrosting	5-10
Bread rolls, 2 pieces	80	240 W	approx. 1		only partially defrost	-
Cake, 1 piece	100-150	80 W	2-5		place in a flan dish	5
Fruit e.g. cherries, strawberries, raspberries, plums	250	240 W	4-5		spread out evenly, turn over halfway through defrosting	5

The times shown in the table are guidelines which may vary according to freezing temperature, quality and weight of the foodstuffs.

Cooking meat, fish, poultry & fresh vegetables					
Food	Quantity -g-	Power Setting-	Time -Min-	Hints	Standing time -Min-
Roasts (pork, veal, lamb)	500	800 W	8-10*	season to taste, place in a shallow flan dish turn over after *	10
	1000	400 W	10-12		10
		800 W	19-21*		10
	1500	400 W	11-14		10
		800 W	33-36*		10
		400 W	13-17		
Roast beef (medium)	1000	800 W	9-11*	season to taste, place in a flan dish, turn over after *	10
		400 W	5-7		
Fish fillet	200	800 W	3-4	season to taste, place in a flan dish, cover	3
Chicken	1200	800 W	21-24	season to taste, place in a shallow flan dish, turn half way through cooking	3
Chicken legs	200	800 W	3-4	season to taste, place, in a flan dish	3
Broccoli	500	800 W	9-11	divide into florets, add 4-5 tbsps water, cover, stir occasionally during cooking	-
Peas	500	800 W	9-11	cover, add 4-5 tbsps water, stir occasionally during cooking	-
Carrots	500	800 W	10-12	cut into rings, add 4-5 tbsps water, cover, stir occasionally during cooking	-
	300	800 W	7-9		
Boiled Potatoes	500	800 W	9-11	cut into large pieces of a similar size, add a little salt, add 150 ml water, cover, stir occasionally during cooking	-

Recipes

All the recipes in this book are calculated on the basis of 4 servings - unless otherwise stated.

Adapting recipes for the microwave oven

If you would like to adapt your favourite recipes for the microwave, you should take note of the following: Shorten cooking times by a third to a half. Follow the example of the recipes in this book.

Foods which have a high moisture content such as meat, fish, poultry, vegetables, fruit, stews and soups can be prepared in your microwave without any difficulty.

Foods which have little moisture, such as platters of food, should have the surface moistened prior to heating or cooking.

The amount of liquid to be added to raw foods, which are to be braised, should be reduced to about two thirds of the quantity in the original recipe. If necessary, add more liquid during cooking.

The amount of fat to be added can be reduced considerably. A small amount of butter, margarine or oil is sufficient to flavour food. For this reason your microwave is excellent for preparing low-fat foods as part of a diet.

Mushroom soup

Utensil: Bowl with lid (2 l Capacity)

Ingredients

200 g	mushrooms, sliced
50 g	onion, finely chopped
300 ml	meat stock
300 ml	cream
25 g	flour
25 g	butter or margarine
	salt & pepper
1	egg
150 g	crème fraiche

Zürich veal stew

Utensils: Dish with lid (2 l capacity)

Ingredients

600 g	veal fillet
10 g	butter or margarine
50 g	onion, finely chopped
100 ml	white wine
	seasoned gravy browning, for approx. 1/2 l gravy
300 ml	cream
1 tbsp	parsley, chopped

Stuffed ham

Utensil: Bowl with lid (2 l capacity)

Oval gratin dish (approx. 26 cm long)

Ingredients

125 g	leaf spinach, chopped
125 g	fromage frais, 20 % fat content
40 g	Emmental cheese, grated
	pepper, paprika
6 slices	cooked ham (300 g)
125 ml	water
125 ml	cream
20 g	flour
20 g	butter or margarine
10 g	butter or margarine to grease the dish

Tip: You can buy ready-made béchamel sauce and use it for this recipe.

- Place the vegetables and the stock in the bowl, cover and cook.
8-9 min. ▲ 800 W
 - Blend all the ingredients in the mixer.
 - Mix the flour and butter to a paste and blend into the soup. Season with salt and pepper, cover and cook. Stir after cooking.
4-6 min. ▲ 800 W
 - Mix the egg yolk with the cream, gradually stir into the soup. Heat for a short time, but do not let it boil!
1-2 min. ▲ 800 W
After cooking, stand for approx. 5 min.
- Cut the veal into strips.
 - Grease the dish with the butter. Put the meat and onion into the dish, cover and cook. Stir once during cooking.
7-10 min. ▲ 800 W
 - Add the white wine, gravy browning and cream, stir, cover and continue cooking. Stir occasionally.
4-5 min. ▲ 800 W
 - Stir the mixture after cooking, stand for approx. 5 min. Garnish with parsley.
- Mix the spinach with the cheese and fromage frais, season to taste.
 - Place a tablespoon of the filling on top of each slice of cooked ham, and roll up. Spear the ham with a wooden skewer to fasten it.
 - Make a béchamel sauce: to do this pour the water and cream into a bowl and heat.
3-4 min. ▲ 800 W
Mix the flour and butter to make a roux, add to the liquid, and whisk until dissolved. Cook until thick.
1 min. ▲ 800 W
Stir and taste.
 - Place the sauce into the greased dish, place the filled rolls of ham into the sauce and cover with lid.
3-4 min. ▲ 800 W
After cooking, stand for approx. 5 min.

Lasagne

Utensils: Bowl with lid (2 l capacity)
Shallow square dish with lid
(approx. 20 x 20 x 6 cm)

Ingredients

300 g tinned tomatoes
50 g ham, chopped
50 g onion, finely chopped
1 clove of garlic, crushed
250 g minced beef
2 tbsp tomato puree
salt & pepper
150 ml crème fraiche
100 ml milk
50 g Parmesan cheese, grated
1 tsp mixed chopped herbs
1 tsp olive oil
1 tsp vegetable oil to grease the dish
125 g lasagne verde
1 tbsp Parmesan cheese, grated

Ratatouille

Utensils: Bowl with lid (2 l capacity)

Ingredients

5 tbsp olive oil
1 clove garlic, crushed
50 g onion, sliced
250 g aubergine, cubed
250 g courgette, cubed
200 g pepper, large cubes
75 g fennel, large cubes
1 bouquet garni
200 g tinned artichoke hearts, cut into quarters
salt & pepper

1. Chop the tomatoes, mix with the ham and onion, garlic, minced beef and tomato puree. Season, cover and cook.

7-9 min. \triangleleft **800 W**

2. Mix the crème fraiche with the milk, Parmesan cheese, herbs, oil, and spices.
3. Grease the dish and cover the bottom with about $\frac{1}{3}$ of the pasta. Put half of the minced meat mixture on the pasta and pour on some sauce. Put an additional $\frac{1}{3}$ of the pasta on top followed by another layer of the minced meat mixture and some sauce, finishing with the remaining pasta on top. Finally, cover the pasta with sauce and sprinkle with Parmesan cheese. Cook with the lid on.

15-17 min. \triangleleft **560 W**

After cooking, stand for approx. 5-10 min.

1. Place the olive oil and garlic in the bowl. Add the prepared vegetables, except the artichoke hearts, and season with pepper. Add the bouquet garni, cover and cook, stirring once.

19-21 min. \triangleleft **800 W**

For the last 5 min, add the artichoke hearts and cook.

2. Season the ratatouille to taste with salt and pepper. Remove the bouquet garni before serving. After cooking, stand for approx. 2 min.

Tip: Ratatouille can be served hot with meat dishes. Served cold, it also makes an excellent starter.

Tip: A bouquet garni consists of: one stalk of parsley, a bunch of herbs suitable for seasoning soup, one stalk of lovage, one stalk of thyme, several bay leaves.

Sole fillets

Utensils: Shallow, oval dish with microwave cling film (approx. 26 cm long)

Ingredients

400 g sole fillets
 1 lemon, whole
 150 g tomatoes
 10g butter
 1 tbsp vegetable oil
 1 tbsp parsley, chopped
 salt & pepper
 4 tsps white wine
 20 g butter or margarine

1. Wash the fish and pat dry. Remove any bones.
2. Cut the lemon and the tomatoes into thin slices.
3. Grease the dish with butter. Place the fish fillets in the dish and drizzle with vegetable oil.
4. Sprinkle parsley over the fish, place the tomato slices on top and season. Place the lemon slices on top of the tomatoes and pour the white wine over them.
5. Place small pats of butter on top of the lemon, cover and cook.

13-16 min. \triangleleft **800 W**

After cooking, stand for approx. 2 min.

Tip: This recipe can also be used for Haddock, Halibut, Mullet, Plaice or Cod.

Fruit jelly with vanilla sauce

Utensils: Dish with lid (2 l capacity)
 Dish with lid (1 l capacity)

Ingredients

150 g redcurrants, washed and stalks removed
 150 g strawberries, washed and hulls removed
 150 g raspberries, washed and hulls removed
 250 ml white wine
 100 g sugar
 50 ml lemon juice
 8 gelatin leaves
 300 ml milk
 1/2 vanilla pod
 30 g sugar
 15 g cornflour

Tip: You can also use defrosted frozen fruits.

1. Put some of the fruit to one side for decoration. Purée the rest of the fruit with the white wine, put it into a dish, cover and heat.
7-9 min. \triangleleft **800 W**
2. Stir in the sugar and the lemon juice.
3. Soak the gelatin in cold water for approx. 10 min, then take it out and squeeze dry. Stir the gelatin into the hot purée until it has dissolved. Place the jelly in the refrigerator and leave to set.
4. To make the vanilla sauce; put the milk into the other dish. Slit the vanilla pod and remove the insides, stir this into the milk with the sugar and the cornflour. Cover and cook, stir during cooking and again at the end.
3-4 min. \triangleleft **800 W**
5. Turn out the jelly onto a plate and decorate with the remaining fruit. Pour the vanilla sauce over the jelly.

Care & cleaning



CAUTION: DO NOT USE COMMERCIAL OVEN CLEANERS, STEAM CLEANERS, ABRASIVE, HARSH CLEANERS, ANY THAT CONTAIN SODIUM HYDROXIDE OR SCOURING PADS ON ANY PART OF YOUR MICROWAVE OVEN.



CLEAN THE OVEN AT REGULAR INTERVALS AND REMOVE ANY FOOD DEPOSITS. Failure to maintain the oven in a clean condition could lead to a deterioration of the surface that could adversely affect the life of the appliance and possibly result in a hazardous situation.

Oven exterior

The outside of your oven can be easily cleaned with mild soap and water.

Make sure that the soap is wiped off with a moist cloth, and dry the exterior with a soft towel.

Control panel

Open the door before cleaning to deactivate the control panel. Care should be taken in cleaning the control panel.

Using a cloth dampened with water only, gently wipe the panel until it becomes clean. Avoid using excessive amounts of water. Do not use any sort of chemical or abrasive cleaner.

Oven interior

1. For cleaning, wipe any spatters or spills with a soft damp cloth or sponge after each use while the oven is still warm. For heavier spills, use mild soap and wipe several times with a damp cloth until all residues are removed.
2. Make sure that mild soap or water do not penetrate the small vents in the walls which may cause damage to the oven.
3. Do not use spray type cleaners on the oven interior.

Turntable & turntable support

Remove the turntable and turntable support from the oven. Wash the turntable and turntable support in mild soapy water. Dry with a soft cloth. Both the turntable and the turntable support are dishwasher safe.

Door

To remove all trace of dirt, regularly clean both sides of the door, the door seals and surfaces with a soft, damp cloth.

Note: *A steam cleaner should not be used.*

Troubleshooting

Symptom	Possible symptoms/remedies
... the microwave appliance is not working properly?	Check that <ul style="list-style-type: none"> - the fuses in the fuse box are working, - there has not been a power outage, - If the fuses continue to blow, please contact a qualified electrician.
... the microwave mode is not working?	Check that <ul style="list-style-type: none"> - the door is properly closed, - the door seals and their surfaces are clean, - the START/+30-button has been pressed.
... the turntable is not turning?	Check that <ul style="list-style-type: none"> - the turntable support is correctly connected to the drive, - the ovenware does not extend beyond the turntable, - food does not extend beyond the edge of the turntable preventing it from rotating, - there is nothing in the well beneath the turntable.
... the microwave will not switch off?	<ul style="list-style-type: none"> - Isolate the appliance from the fuse box. - Call your local Service Force Centre.
... the interior light is not working?	<ul style="list-style-type: none"> - Call your local Service Force Centre. The interior light bulb can be exchanged only by a trained Service Force technician.
... the food is taking longer to heat through and cook than before?	<ul style="list-style-type: none"> - Set a longer cooking time (double quantity = nearly double time) or - if the food is colder than usual, rotate or turn from time to time or - set a higher power setting.

Note: If you cook the food over the standard time with only 800 W, the power of the oven will lower automatically to avoid overheating.

(The microwave power level will be reduced to 560 W). After pausing for 90 seconds, 800 W power can be reset.

Cooking mode	Standard time	Reduced power level
Microwave 800 W	20 minutes	Microwave 560 W

Specifications

AC Line Voltage	:	230-240 V, 50 Hz, single phase
AC Power required:	Microwave	: 1.2 kW
Output power:	Microwave	: 800 W (IEC 60705)
Microwave Frequency	:	2450 MHz * (Group 2, Class B)
Outside Dimensions	:	592 mm (W) x 370 mm (H) x 316 mm (D)
Cavity Dimensions	:	285 mm (W) x 202 mm (H) x 298 mm (D) **
Oven Capacity	:	17 litres **
Turntable	:	ø 272 mm, glass
Weight	:	approx. 15.5 kg
Oven lamp	:	25 W/240 - 250 V

- * This Product fulfils the requirement of the European standard EN55011. In conformity with this standard, this product is classified as group 2 class B equipment. Group 2 means that the equipment intentionally generates radio-frequency energy in the form of electromagnetic radiation for the heat treatment of food. Class B equipment means that the equipment is suitable to be used in domestic establishments.
- ** Internal capacity is calculated by measuring maximum width, depth and height. Actual capacity for holding food is less.



This oven complies with the requirements of Directives 89/336/EEC and 73/23/EEC as amended by 93/68/EEC.
SPECIFICATIONS ARE SUBJECT TO CHANGE WITHOUT NOTICE AS PART OF CONTINUOUS IMPROVEMENT

Installation

Installing the appliance

1. Remove all packaging and check carefully for any signs of damage.
2. This oven is designed to fit into a 360 mm high cupboard as standard. When fitting into a 350 mm high cupboard:- Unscrew and remove the 4 feet from the bottom of the oven. There are 3 tall feet and 1 short foot. Replace the 3 tall feet with those provided in the accessory pack. Do not replace the short foot.
3. If fitting the microwave oven above a conventional oven (position A on page 37) then use the mylar sheet provided.
 - a. Cut the Mylar sheet to fit the internal width of the unit.
 - b. Peel back the protective cover on the tape and fix to the rear of the shelf so that it covers the service gap. (See diagram below).

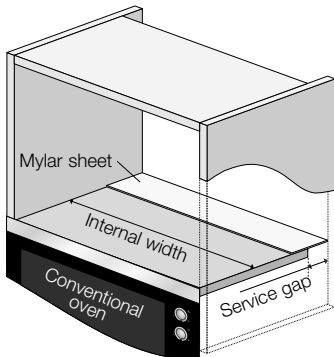

4. Fit the appliance into the kitchen cupboard slowly, and without force, until the front frame of the oven seals against the front opening of the cupboard.
5. Ensure the appliance is stable and not leaning. Ensure that a 5 mm gap is kept between the cupboard door above and the top of the frame (see diagram).



6. Fix the oven in position with the screws provided. The fixing points are located on the top and bottom corners of the oven (see diagram, item 9, on page 9).

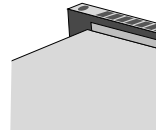

7. It is important to ensure that the installation of this product conforms to the instructions in this operation manual and the hob or conventional oven manufacturer's installation instructions.

Safe use of the appliance

If fitting the microwave in position B or C:

- The cupboard must be a minimum of 500 mm (E) above the worktop and must not be installed directly above a hob.
- This appliance has been tested and approved for use near domestic gas, electric and induction hobs only.
- Sufficient space between hob and microwave should be allowed to prevent overheating of microwave oven, surrounding cupboard and accessories.
- Do not operate the hob without pans when the microwave oven is operating.
- Care should be taken when attending to the microwave oven while the hob is on.

Position	Niche Size W D H	Chimney (min)	Gap Between Cupboard & Ceiling
A	560x550x360	50	50
B+C	560x300x350	15	50
	560x300x360	15	50
D	560x500x350	40	50
	560x500x360	40	50

Measurements in (mm)

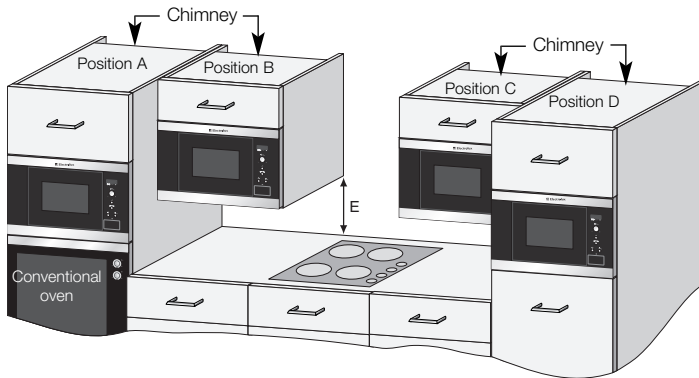

Connecting the appliance to the power supply

- **The electrical outlet should be readily accessible so that the unit can be unplugged easily in an emergency.**
 - **The socket should not be positioned behind the cupboard.**
 - The best position is above the cupboard, see (A).
- When not connecting the power supply cord to position (A) it should be removed from the support clip (see diagram, item 13, on page 9) and routed under the oven.

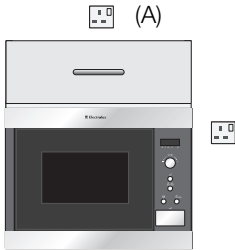

- Connect the appliance to a single phase 230-240 V/50 Hz alternating current via a correctly installed earth socket.
- **If the appliance is to be operated in a non-European country, the supply voltage, current type and frequency of the appliance indicated on the rating plate must correspond with the specification of your power supply. The rating plate can be found on the inside face of the control panel.**
- **The power supply cord may only be replaced by an electrician.**

- Before installing, tie a piece of string to the power supply cord to facilitate connection to point (A) when the appliance is being installed.
- When inserting the appliance into the high-sided cupboard, DO NOT crush the power supply cord.

Electrical Connections



WARNING: THIS APPLIANCE MUST BE EARTHED.

The manufacturer declines any liability should this safety measure not be observed.

- If the plug that is fitted to your appliance is not suitable for your socket outlet, it must be cut off and the appropriate plug fitted.
- Remove the fuse from the cut off plug. The cut off plug should then be disposed of to prevent the hazard of shocks in case it should be plugged into a 13 Amp socket in another part of your home.

IMPORTANT

The wires in the mains lead are coloured in accordance with the following code:

GREEN AND YELLOW	EARTH
BLUE	NEUTRAL
BROWN	LIVE

If you fit your own plug, the colours of the wires in the mains lead of your appliance may not correspond with the markings identifying the terminals in your plug, proceed as follows:

- Connect the green and yellow (earth) wire to the terminal in the plug which is marked with the letter "E" or the earth symbol (\perp) or coloured green and yellow.
- Connect the blue (neutral) wire to the terminal in the plug which is marked with the letter "N" or coloured black.
- Connect the brown (live) wire to the terminal in the plug which is marked with the letter "L" or coloured red.

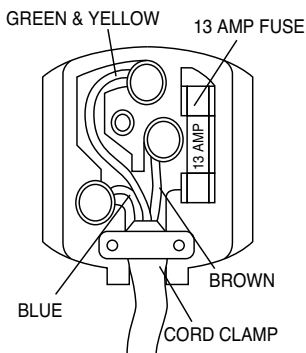

Environmental information

Ecologically responsible disposal of packaging materials and old appliances

Packaging materials

Electrolux microwave ovens require effective packaging to protect them during transportation. Only the minimum packaging necessary is used. Packaging materials (e.g. foil or styrofoam) can place children at risk.

Danger of suffocation. Keep packaging material away from children.

All packaging materials used are environment friendly and can be recycled. The cardboard is made from recycled paper and the wooden parts are untreated. Plastic items are marked as follows:

- «PE» polyethylene eg packaging film
- «PS» polystyrene eg packaging (CFC-free)
- «PP» polypropylene eg packaging straps

By using and re-using the packaging, raw materials are saved and waste volume is reduced. Packaging should be taken to your nearest recycling centre. Contact your local council for information.

Disposal of old appliances

Old appliances should be made safe before disposal by removing the plug, and cutting off and disposing of the power cable.

It should then be taken to the nearest recycling centre. Check with your local Council or Environmental Health Office to see if there are facilities in your area for recycling the appliance.

The symbol  on the product or on its packaging indicates that this product may not be treated as household waste. Instead it shall be handed over to the applicable collection point for the recycling of electrical and electronic equipment. By ensuring this product is disposed of correctly, you will help prevent potential negative consequences for the environment and human health, which could otherwise be caused by inappropriate waste handling of this product. For more detailed information about recycling of this product, please contact your local city office, your household waste disposal service or the shop where you purchased the product.

Guarantee / Customer service

Standard guarantee conditions

We, Electrolux, undertake that if within 12 months of the date of the purchase this Electrolux appliance or any part thereof is proved to be defective by reason only of faulty workmanship or materials, we will, at our option repair or replace the same FREE OF CHARGE for labour, materials or carriage on condition that:

- The appliance has been correctly installed and used only on the electricity supply stated on the rating plate.
- The appliance has been used for normal domestic purposes only, and in accordance with the manufacturer's instructions.
- The appliance has not been serviced, maintained, repaired, taken apart or tampered with by any person not authorised by us.
- Electrolux Service Force Centre must undertake all service work under this guarantee.
- Any appliance or defective part replaced shall become the Company's property.
- This guarantee is in addition to your statutory and other legal rights.

Exclusions

- Damage or calls resulting from transportation, improper use or neglect, the replacement of any light bulbs or removable parts of glass or plastic.
- Costs incurred for calls to put right an appliance which is improperly installed or calls to appliances outside the United Kingdom.

- Appliances found to be in use within a commercial environment, plus those which are subject to rental agreements.
- Products of Electrolux manufacturer that are not marketed by Electrolux.

Service & spare parts

In the event of your appliance requiring service, or if you wish to purchase spare parts, please contact your local Service Force Centre by telephoning:

08705 929 929

Your telephone call will be automatically routed to the Service Force Centre covering your post code area.

For the address of your local Service Force Centre and further information about Service Force, please visit the website at

www.serviceforce.co.uk

Before calling out an engineer, please ensure you have read the details under the heading "Troubleshooting".

When you contact the Service Force Centre you will need to give the following details:

1. Your name, address and postcode.
2. Your telephone number.
3. Clear and concise details of the fault.
4. The model and serial number of the appliance (found on the rating plate).
5. The purchase date.

Please note that a valid purchase receipt or guarantee documentation is required for in-guarantee service calls.

Customer care

For general enquiries concerning your Electrolux appliance, or for further information on Electrolux products please contact our Customer Care Department by letter or telephone at the address below or visit our website at www.electrolux.co.uk

Customer Care Department
Electrolux Major Appliances
Addington Way
Luton

Bedfordshire, LU4 9QQ

Tel: 08705 950 950 (*)

(*) Calls may be recorded for training purposes

European guarantee



This appliance is guaranteed by Electrolux in each of the countries listed at the back of this user manual, for the period specified in the appliance guarantee or otherwise by law. If you move from one of these countries to another of the countries listed below the appliance guarantee will move with you subject to the following qualifications:-

- The appliance guarantee starts from the date you first purchased the appliance which will be evidenced by production of a valid purchase document issued by the seller of the appliance.
- The appliance guarantee is for the same period and to the same extent for labour and parts as exists in your new country of residence for this particular model or range of appliances.
- The appliance guarantee is personal to the original purchaser of the appliance and cannot be transferred to another user.

- The appliance is installed and used in accordance with instructions issued by Electrolux and is only used within the home i.e. is not used for commercial purposes.
- The appliance is installed in accordance with all relevant regulations in force within your new country of residence.

The provisions of this European Guarantee do not affect any of the rights granted to you by law.

www.electrolux.com

		
Albania	+35 5 4 261 450	Rr. Pjeter Bogdani Nr. 7 Tirane
Belgique/België/ Belgien	+32 2 363 04 44	Bergensesteenweg 719, 1502 Lembeek
Česká republika	+420 2 61 12 61 12	Budějovická 3, Praha 4, 140 21
Danmark	+45 70 11 74 00	Sjællandsgade 2, 7000 Fredericia
Deutschland	+49 180 32 26 622	Muggenhofer Str. 135, 90429 Nürnberg
Eesti	+37 2 66 50 030	Mustamäe tee 24, 10621 Tallinn
España	+34 902 11 63 88	Carretera M-300, Km. 29,900 Alcalá de Henares Madrid
France	www.electrolux.fr	
Great Britain	+44 8705 929 929	Addington Way, Luton, Bedfordshire LU4 9QQ
Hellas	+30 23 10 56 19 70	4, Limnou Str., 54627 Thessaloniki
Hrvatska	+385 1 63 23 338	Slavonska avenija 3, 10000 Zagreb
Ireland	+353 1 40 90 753	Longmile Road Dublin 12
Italia	+39 (0) 434 558500	C.so Lino Zanussi, 26 - 33080 Porcia (PN)
Latvija	+37 17 84 59 34	Kr. Barona iela 130/2, LV-1012, Riga
Lituania	+370 5 27 80 609	Verkiu 29, 09108 Vilnius, Lithuania
Luxembourg	+35 2 42 43 13 01	Rue de Bitbourg, 7, L-1273 Hamm
Magyarország	+36 1 252 1773	H-1142 Budapest XIV, Erzsébet királyné útja 87
Nederland	+31 17 24 68 300	Vennootsweg 1, 2404 CG - Alphen aan den Rijn
Norge	+47 81 5 30 222	Risløkkvn. 2 , 0508 Oslo
Österreich	+43 18 66 400	Herziggasse 9, 1230 Wien
Polska	+48 22 43 47 300	ul. Kolejowa 5/7, Warsaw
Portugal	+35 12 14 40 39 39	Quinta da Fonte - Edifício Gonçalves Zarco - Q 35 -2774-518 Paço de Arcos
Romania	+40 21 44 42 581	B-dul Timisoara 90, S6, Bucharest
Schweiz - Suisse - Svizzera	+41 62 88 99 111	Industriestrasse 10, CH-5506 Mägenwil
Slovenija	+38 61 24 25 731	Tržaška 132, 1000 Ljubljana
Slovensko	+421 2 43 33 43 22	Electrolux Slovakia s.r.o., Electrolux Domáce spotrebiče SK, Seberíniho 1, 821 03 Bratislava
Suomi	www.electrolux.fi	
Sverige	+46 (0)771 76 76 76	Electrolux Service, S:t Göransgatan 143, S-105 45 Stockholm
Türkiye	+90 21 22 93 10 25	Tarlabası caddesi no : 35 Taksim İtanbul
Россия	+7 095 937 7837	129090 Москва, Олимпийский проспект, 16, Бц "Олимпик"



www.electrolux.com

www.electrolux.co.uk