

COMPETENCE B8100-1

The Versatile Built-in Oven

Operating Instructions



Dear customer,

Please read these operating instructions carefully.

Pay particular attention to the section "Safety information" on the first few pages. Please retain these operating instructions for later reference. Pass them on to possible new owners of the appliance.

The following symbols are used in the text:



Safety instructions

Warning: Information concerning your personal safety.

Important: Information on how to avoid damaging the appliance.



Information and practical tips



Environmental information

1. These numbers indicate step by step how to use the appliance.
2. ...
3. ...

In the event of any technical problems please contact your nearest CUSTOMER SERVICE CENTRE at any time. (Addresses and telephone numbers may be found in the appendix under "Customer Service Centres").

You should also refer to the section "Service".

Contents

Safety	5
Disposal	7
Description of the Appliance	8
General Overview	8
Control Panel	9
Oven Features	10
Oven accessories	11
Before Using for the First Time	12
Setting the Time	12
Initial Cleaning	13
Using the Oven	14
The Electronic Oven Control	14
Oven Functions	15
Inserting the Shelf and Universal Baking Tray	19
Inserting/Removing the Fat Filter	20
Additional Functions	21
Clock Functions	26
Other Functions	32
Oven Child Safety Feature	33
Button Locking Feature	34
Oven safety cut-out	35
Uses, Tables and Tips	36
Baking	36
Baking Table	38
Pies and Gratin Table	42
Frozen Ready Meals Table	43
Roasting	44
Roasting Table	46
Meat Probe Table	48
Grilling	49
Grilling Table	49
Bio-Functions	50
Low Temperature Roasting Table	52
Making Yoghurt	53
Proving Dough	53
Drying	54

Defrosting	55
Defrosting Table	55
Preserving	56
Cleaning and Care	58
Exterior of the Appliance	58
Oven Interior	58
Accessories	59
Fat Filter	59
Shelf Support Rails	60
Oven Lighting	61
Cleaning the Oven Ceiling	62
Oven Door	63
Oven Door Glass	64
What to do if	66
Technical Data	67
Oven Interior Dimensions	67
Regulations, Standards, Directives	67
Index	70
Service	71



Safety

Electrical Safety

- The appliance may only be connected by a **registered specialist**.
- In the event of any faults or damage to the appliance: remove fuses or switch off.
- It is **not permissible** to clean the appliance with a steam or high pressure cleaner for safety reasons!
- **Repairs** to the appliance may **only be carried out by specialists**. Repairs carried out by inexperienced persons may cause injury or serious malfunctioning. If your appliance needs repairing, please contact your local AEG Service Force Centre or your specialist dealer.

Child Safety

- Never leave children unsupervised when the appliance is in use.

Safety whilst Using

- This appliance is intended to be used for cooking, frying and baking food in the home.
- Take care when connecting electric appliances to sockets nearby. Do **not** allow connecting leads to come into contact with hot rings or to catch beneath the hot oven door.
- **Warning: Risk of burns!** The interior of the oven becomes hot during use.
- Using ingredients containing alcohol in the oven may create an alcohol-air mixture that is easily ignited. In this case, open the door carefully. Do not have embers, sparks or naked flames in the vicinity when opening the door.

To Avoid Damaging Your Appliance

- Do not line your oven with aluminium foil and do not place a baking tray or dish on the oven floor, otherwise the oven enamel will be damaged by the resulting build up of heat.
- Juice from fruit that drips from baking trays will leave marks that cannot be removed. For very moist cakes, use the universal baking tray.
- Do not put any weight on the oven door when it is open.
- Never pour water directly into the hot oven. The enamel may be damaged.
- Using force, especially on the edges of the front glass panel, may break the glass.
- Do not store inflammable objects in the oven. They may ignite when the oven is switched on.
- Do not store moist food in the oven. The enamel may be damaged.



Disposal

Disposing of the packaging material

All materials used can be fully recycled.

Plastics are marked as follows:

- >PE< for polyethylene, as used for the outer wrapping and the bags inside.
- >PS< for polystyrene foam, e.g., as used for the padding materials. They are completely free of CFCs.

Disposal of old appliances



Warning: Before disposing of old appliances please make them inoperable so that they cannot be the source of danger.

To do this, disconnect the appliance from the mains supply and remove the mains lead.

To protect the environment, it is important that worn out appliances are disposed of in the correct manner.

- The appliance must not be disposed of with household rubbish.
- You can obtain information about collection dates or public refuse disposal sites from your local refuse department or council.

Description of the Appliance

General Overview

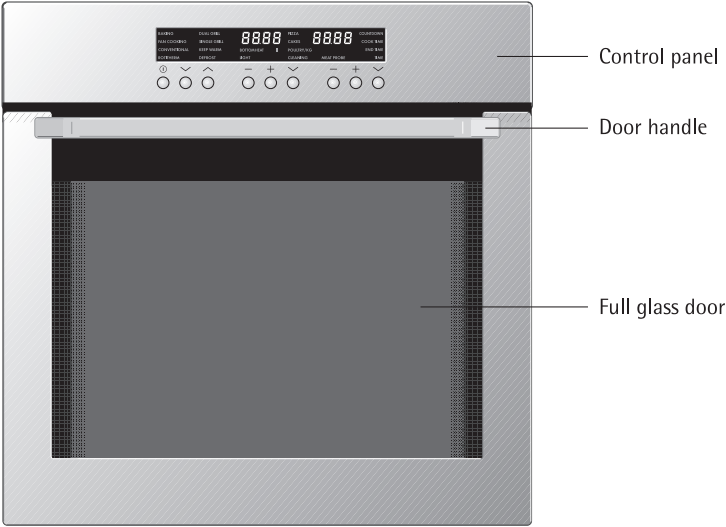

Control Panel

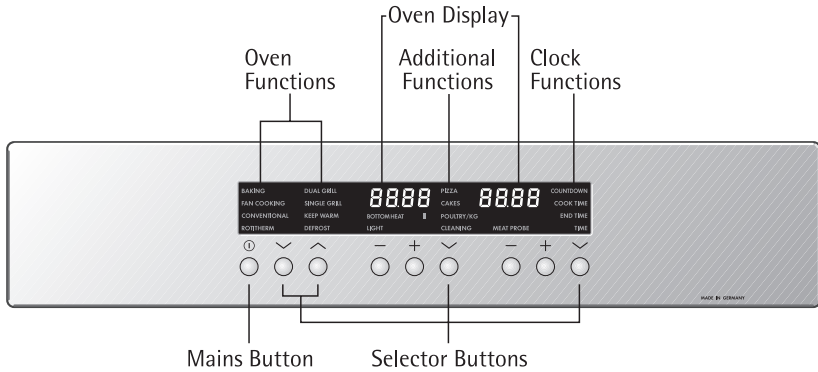

Mains button

For switching the entire appliance on and off.

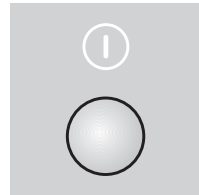

Mains button on appliances with a metal front



In the following text and in the illustrations the symbol  is always used to indicate the mains button.

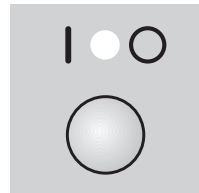

Oven Features

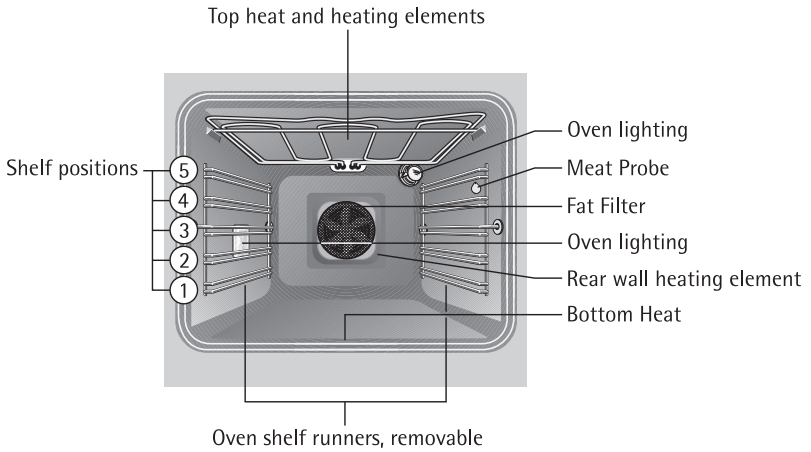

Oven steam vent

Steam from the oven is fed out below the door handle.

Relates only to appliances with a metal front:

Steam from the oven is fed out between the upper door edge and the control panel.

Oven accessories

Combination shelf

For dishes, cake tins, items for roasting and grilling.

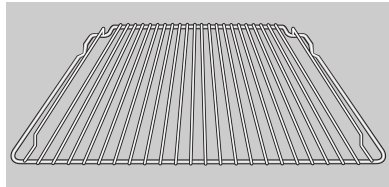

Baking tray

For cakes and biscuits.

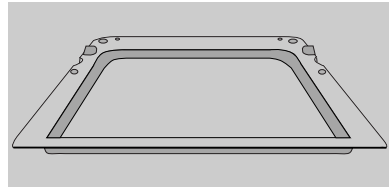

Fat tray

For roasting or for collecting fat.

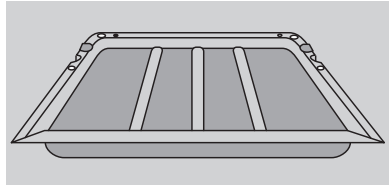

Meat probe

For determining exactly how far joints of meat are cooked.

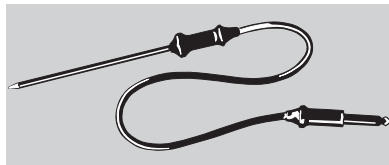

Before Using for the First Time

Setting the Time

i The oven will only operate when the time has been set.

After connection to the mains or following a power failure "12.00" is illuminated and "TIME" flashes.



1. Using buttons \oplus or \ominus set the current time.



2. Wait for approx. 5 seconds.

The flashing will stop and the set time is displayed.

The appliance is ready for use.



Initial Cleaning

Before using the oven for the first time you should clean it thoroughly.



Important: Do not use any caustic, abrasive cleaners! The surface could be damaged.





Tip: Use commercially available cleaners for metal fronts.

Switch on the appliance using the mains button.
The symbol above the button will be illuminated.

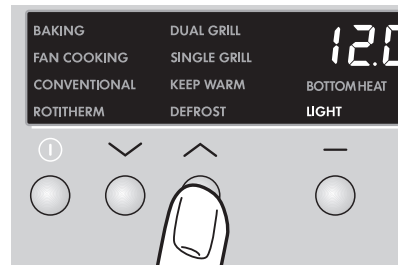

3. Press selection button  once for oven functions.
"LIGHT" is illuminated and the oven lighting is switched on.





4. Remove all accessories and the shelf support rails and wash them with warm water and washing up liquid.
5. Then wash out the oven with warm water and washing-up liquid, and dry.
6. Wipe the front of the appliance with a damp cloth.
7. After cleaning switch off the oven lighting using selection button  for oven functions.

Using the Oven

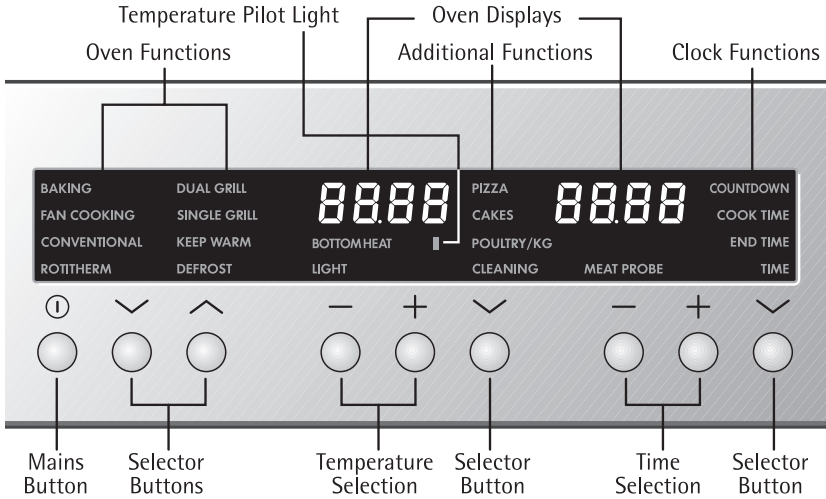
The Electronic Oven Control



General information

- Always switch the appliance on first using the mains button .
- When the selected function is illuminated the oven starts to heat up and the set time begins to count down.
- The oven lighting comes on as soon as an oven function is selected.
- Switch the appliance off using the mains button .

Oven Functions

The oven has the following functions:



The BAKING, CONVENTIONAL and ROTITHERM functions include an **automatic fast warm up**. This ensures that the selected temperature is reached as quickly as possible.

BAKING

Suggested temperature: 150 °C

For baking cakes on **one level** and for pastries that need more browning and a crispy base. These include such foods as pizza, quiche lorraine, and cheese cake.

Set oven temperatures 20–40 °C lower than when using conventional. Conventional is used and in addition the fan is switched on.

FAN COOKING

Suggested temperature: 150 °C

For **baking on up to three levels** at the same time.

Set oven temperatures 20–40 °C lower than when using conventional.

The rear wall heating element is used and in addition the fan is switched on.

CONVENTIONAL

Suggested temperature: 200 °C

For **baking** and **roasting** on **one level**.

The top and bottom heating elements are in use.

ROTITHERM

Suggested temperature: 180 °C

For **roasting** larger pieces of meat or poultry on one level. This function is also suited to **cooking foods au gratin** and **browning**.

The grill heating element and top heat operate alternately with the fan.

DUAL GRILL

Suggested temperature: 300 °C

For **grilling larger quantities** of flat foods such as steaks, escalopes or fish, or for **toasting**.

Top heat and the grill heating element are in use.

SINGLE GRILL

Suggested temperature: 300 °C

For **grilling** flat foods placed on the **middle of the shelf** such as steaks, escalopes or fish, or for **toasting**.

The grill heating element is in use.

KEEPING FOOD WARM

Temperature setting: 80 °C

To keep food warm.

The top and bottom heating elements are in use.

DEFROST

Temperature setting: 30 °C

To **begin to thaw and to defrost** such items as flan, butter, bread, fruit or other **frozen foods**.

For this function the fan operates **without** heating.

BOTTOM HEAT

Suggested temperature: 150 °C

For **crisping and browning** cakes with **crispy bases**.



The bottom heating element is in use.

LIGHT

To switch the oven lighting on and off.

The oven lighting is switched on automatically as long as the oven is in operation.

Switching On Oven Functions

1. Switch the appliance on with the mains button .
2. Press selection button  or  until the required function is illuminated.





A suggested temperature will appear in the temperature display.

The temperature pilot light comes on while the oven is heating up.





Changing the Oven Temperature

Press the  or  button to increase or decrease the temperature.

The temperature may be set at intervals of 5 °C.





Changing the Oven Function

Press the  or  button repeatedly until the required function is illuminated.



Switching the Oven Off

To switch the oven off press selection button  or  repeatedly until none of the oven functions is illuminated.





Cooling fan

The fan comes on automatically when the oven is in use in order to keep the surfaces of the appliance cool. Once the oven has been switched off, the fan continues running to cool down the appliance and then switches itself off automatically.

Switching the Oven Lighting On and Off

You can also switch on the oven lighting without an oven function.

1. Switch the appliance on using the mains button .
2. Press selection button  once for oven functions. "LIGHT" is illuminated and the oven lighting is switched on.
3. Press selection button  once for oven functions. The oven lighting is switched off.



Inserting the Shelf and Universal Baking Tray



Anti-tip device

All slide-in units have a small bulge on the left and right. This bulge is an anti-tip device and must always point to the rear of the oven.

Tray or universal baking tray:

The anti-tip device must point towards the rear of the oven.

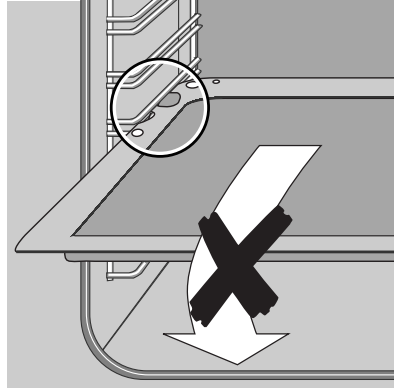

Inserting shelf:

Insert the shelf unit with both guide rails pointing upwards. The anti-tip device must point downwards and be positioned to the rear of the oven compartment.

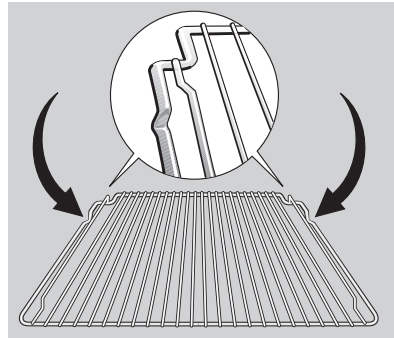

Inserting shelf and tray:

When the shelf unit and universal baking tray are used together, carefully place the shelf anti-tip device in the bulges on the tray.

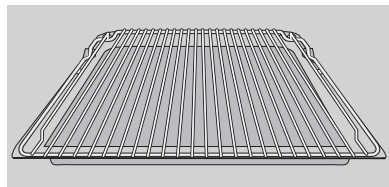

Inserting/Removing the Fat Filter

The fat filter protects the rear wall heating element against splashes of fat when roasting.

Inserting the fat filter

Holding the fat filter by the tab, insert the two retainers into the opening on the rear wall of the oven (fan opening) from the top downwards.

Removing the fat filter

Take hold of the tab on the fat filter and remove by pulling upwards.

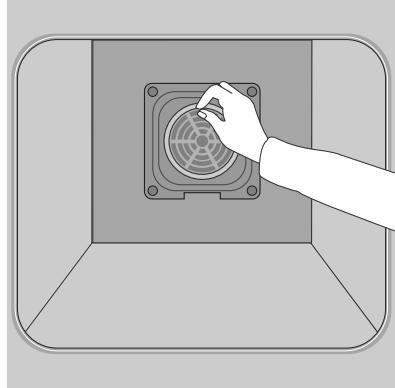

Additional Functions

PIZZA

To bake ready meals such as pizza, lasagne, foods au gratin and chips from the freezer.



There is no need to pre-heat the oven as recommended on the packaging when this special additional function is used.

- i** Refer to the maker's instructions for preparation.
Use the oven temperature for hot air.

1. Press additional functions selection button  repeatedly until the "PIZZA" function is illuminated.

The suggested temperature of "200 °C" will appear in the temperature display.



2. By pressing the relevant  or  button the suggested temperature can be increased or decreased in stages of 10 °C.



- i** Turn chips etc. 2 - 3 times during cooking.

CAKES

For baking prepared cakes and cake mixtures. There is no need to pre-heat the oven as recommended on the packaging when this special additional function is used.



Refer to the maker's instructions for preparation.
Use the oven temperature for hot air.

1. Press additional functions selection button repeatedly until the "CAKES" function is illuminated.

The suggested temperature of "160 °C" will appear in the temperature display.



2. By pressing the relevant or button the suggested temperature can be increased or decreased in stages of 10 °C.



POULTRY



To roast whole poultry on an automatic program where all you need to do is set the weight.

1. Prepare the poultry for roasting then place it breast down in the roasting dish and insert it on the shelf in the first oven position from the bottom.

2. Press additional functions selection button  repeatedly until "POULTRY" is illuminated.

"1.3" will appear in the temperature display and the "COOK TIME" clock function will be illuminated.



3. Press the relevant  or  buttons within the next minute to change the weight setting (0.5 - 2.9).



You can check the COOK TIME by pressing clock functions selection button .



4. After approx. 2/3 of the roasting time an acoustic signal will sound to remind you to turn the poultry.
5. At the end of the cooking time an acoustic signal will sound. The oven will switch off.

CLEANING

To clean the oven.

With this oven function you can heat the oven to the optimum temperature for oven cleaners that require a warm oven to take effect.

The ring heating elements and fan are in use.

Meat Probe

To switch the oven off when the precise meat core temperature has been reached.



Important: Only the meat probe delivered with the oven should be used! If a replacement is required use only an original spare part.

1. Push the tip of the meat probe as far as possible into the food that is to be cooked so that the tip is right in the centre of the food.
2. Push the meat probe plug fully into the socket on the side wall of the oven.
"MEAT PROBE" is illuminated.
3. Set the required oven function and oven temperature.

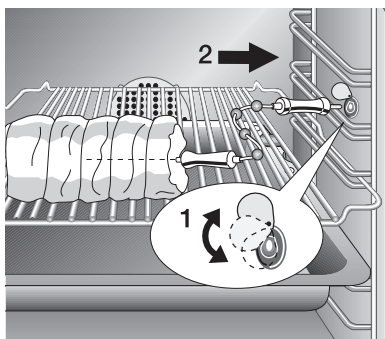

The **suggested temperature** for the selected oven function will appear in the temperature display on the **left**.

In the time display on the **right** a suggested temperature of '60 C' will appear for the **meat core temperature**.



4. Set the required meat core temperature using time selection buttons \oplus or \ominus .



After approx. 5 seconds the current **meat core temperature** will be shown in the time display on the **right**.



i The meat core temperature is displayed from 30 °C upwards.

i **Checking or changing the meat core temperature**

- The set meat core temperature can be displayed by pressing buttons \oplus or \ominus once.
- It is possible to change a previously selected temperature by pressing \oplus or \ominus several times.

As soon as the measured meat core temperature matches the temperature that has been set an acoustic signal will sound and the oven will switch off automatically.

5. Press the \oplus or \ominus time selection button to deactivate the signal.



! **Warning:** The meat probe is hot! There is a risk of burning when the plug and probe are removed!

6. Pull the meat probe plug out of the socket and remove the cooked food from the oven with the meat thermometer still inside it.
7. Switch off the oven.

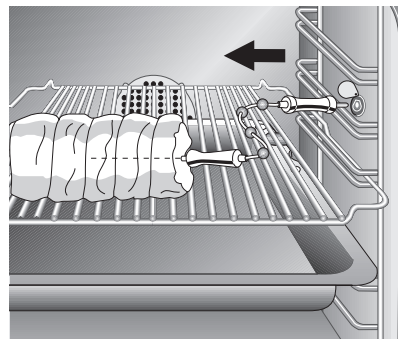

Clock Functions

COUNTDOWN

To set a countdown. A signal sounds after the time has elapsed. This function does not affect the functioning of the oven.

COOK TIME

To set how long the oven is to be in use.

END TIME



To set when the oven is to switch off again.

TIME

To set, change or check the time.
(See also section "Before Using for the First Time".)





General information

- Before setting the time always switch the appliance on using the mains button .
- After a clock function has been selected the function will flash for approx. 5 seconds. During this time the required times can be set or changed using the  or  time selection buttons.
- After the required time has been set the function will flash again for approx. 5 seconds. Then the function stays illuminated. The set time will begin to count down.
- The acoustic signal may be turned off by pressing any clock button.

COUNTDOWN

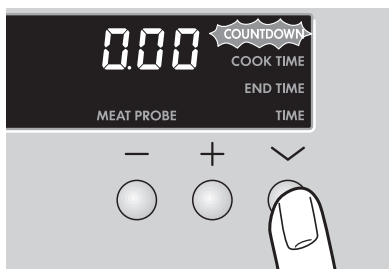
1. Press clock function selection button  repeatedly until COUNT-DOWN is flashing.



2. Using buttons  or  set the required countdown. (Max. 2 hours and 30 minutes.)

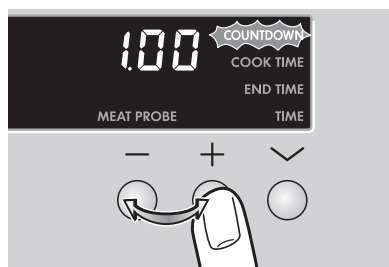

After approx. 5 seconds the display will show the remaining time. COUNTDOWN is illuminated.



When the time has expired COUNT-DOWN flashes and an acoustic signal will sound for 2 minutes.

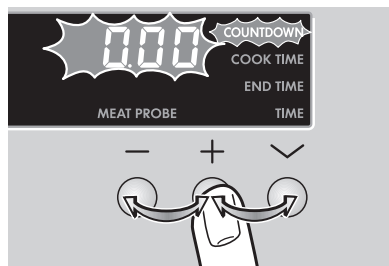

To switch the acoustic signal off: press any clock functions button.

COOK TIME

1. Select oven function and temperature.
2. Press clock function selection button  repeatedly until COOK TIME flashes.

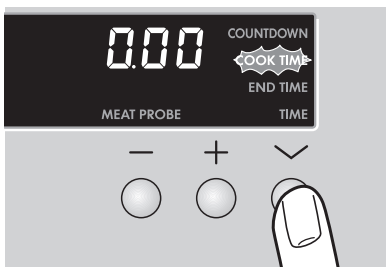

3. Using buttons  or  set the required cooking time.

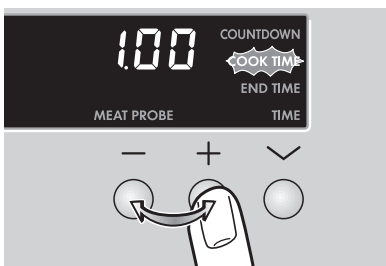

After approx. 5 seconds the display will switch to the time. COOK TIME is illuminated.



When the cooking time has expired COOK TIME will flash, an acoustic signal will sound for 2 minutes and the oven will switch off.

To switch the acoustic signal off: press any clock function button.

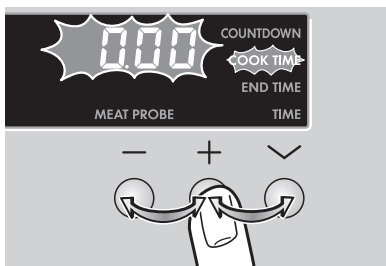

END TIME

1. Select oven function and temperature.
2. Press clock function selection button  repeatedly until END TIME is flashing.



3. Using the  button set the time at which you want the oven to switch off.



After approx. 5 seconds the display will revert to the time. END TIME is illuminated.



4. When the time has expired END TIME will flash, an acoustic signal will sound for 2 minutes and the oven will switch off.

To switch the acoustic signal off: press any clock function button.

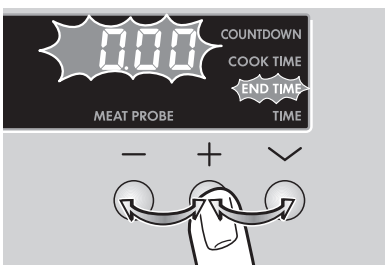

COOK TIME and END TIME Combined



COOK TIME and END TIME can be used together if the oven is to switch on and off automatically at a **later time**.

1. Select oven function and temperature.
2. Using the COOK TIME function set the time required for the dish to cook.
E.g. 1 hour.

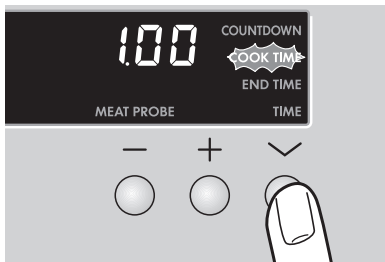

3. Using the END TIME function set the time at which the dish is to be ready.
E.g., 14:05.



4. COOK TIME and END TIME are illuminated and the time will appear in the display. In this case 12:05. The oven will switch on automatically at the calculated time.
E.g., 13:05.



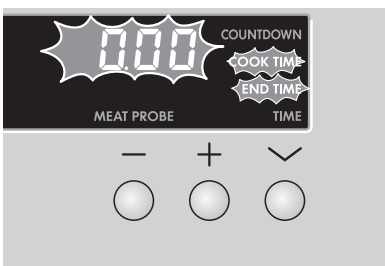

5. After the set period of time has expired an acoustic tone will sound for 2 minutes and the oven will switch off.
E.g., 14:05.
COOK TIME and END TIME will flash.



Changing TIME

1. Press clock function selection button  repeatedly until TIME flashes.



2. Using buttons  or  set the current time.



3. After approx. 5 seconds the flashing will stop and the clock will display the set time.
The appliance is ready for use again.



The TIME can only be changed if the oven and child safety feature are switched off.



Other Functions



Switching Off the Time Display

By switching off the time display you can save energy.

Switching off the time display

1. If necessary **switch off** the appliance with the mains button.
2. Press clock functions  and  simultaneously until the display goes dark (approx. 5 seconds).





As soon as the appliance is used again the display will automatically switch on.

The next time the appliance is switched off the time display will again go out.

To display the time constantly again the time display must be switched on again.

Switching on the time display

1. If necessary **switch off** the appliance with the mains button.
2. Press clock functions selection buttons  and  simultaneously until the display reappears (approx. 5 seconds).





The display can only be switched off if the oven is also switched off.

Oven Child Safety Feature

The oven is equipped with a child safety feature. As soon as the child safety feature is activated, the oven cannot be used.

- i** There must be no oven function selected if the child safety feature is to be switched on.

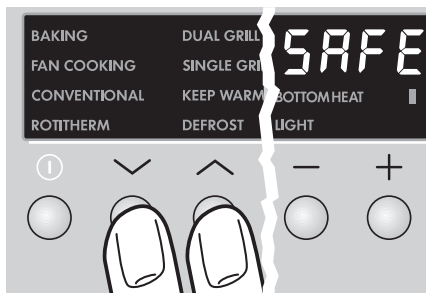

Activating the Child Safety Feature

1. If necessary, switch on the appliance using the mains button.
2. Hold down oven function selector buttons  and  simultaneously until "SAFE" appears in the oven display.



The child safety feature is now activated.

Deactivating the Child Safety Feature

Hold down oven function selector buttons  and  simultaneously for approx. 2 seconds.



The child safety feature is now deactivated and the oven is again ready for use.

- i** Switching off the appliance with the mains button does not cancel the child safety feature.

Button Locking Feature



To prevent a set oven function being adjusted unintentionally.

Activating the button locking feature

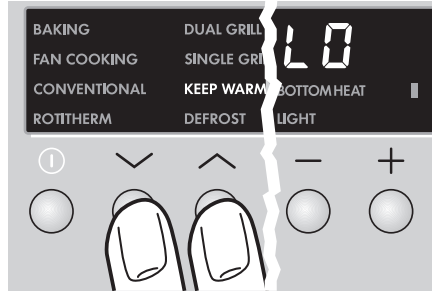
1. If necessary, switch on the appliance using the mains button.
2. Select oven function.
3. Hold down oven function selector buttons  and  simultaneously for approx. 2 seconds until "LO" appears in the display. The button locking feature has now been activated.



Deactivating the button locking feature

Hold down oven function selector buttons  and  simultaneously for approx. 2 seconds.

The button locking feature is automatically deactivated when the appliance is switched off.

Oven safety cut-out



If not switched off after a certain time, or if the temperature does not change, the oven switches off automatically.

The indication "0.00" flashes, the temperature indicator light flashes, and a signal sounds.

The oven switches off at temperatures of:

30 - 120° C	after	12.5 hours
120 - 200° C	after	8.5 hours
200 - 250° C	after	5.5 hours
250 - 300° C	after	1.5 hours

Switching on again after a safety cut-out

Switch the oven off completely.

You will then be able to switch on again.

Uses, Tables and Tips

Baking

Use the BAKING, FAN COOKING or CONVENTIONAL oven functions for baking.

Baking tins

- Cake tins made of dark metal and coated tins are suitable for CONVENTIONAL.
- Baking tins made of light metal are also suitable for BAKING and FAN COOKING.

Shelf positions

- Baking with BAKING or CONVENTIONAL is only possible on one shelf position at a time.
- With FAN COOKING you can bake on up to three baking trays at once:

1 Baking tray
e.g., shelf position 3

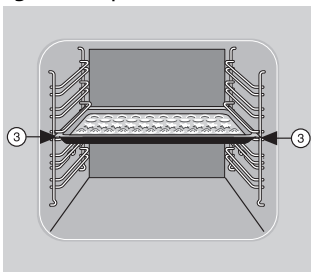

1 Baking tin:
e.g., shelf position 1

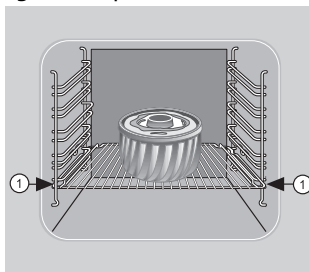

2 Baking trays:
Shelf positions 1 and 4

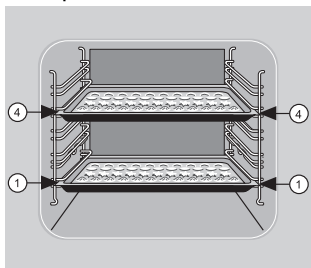

3 Baking trays:
Shelf positions 1, 3 and 5

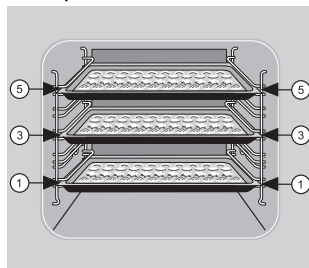



General information

- **Remove the fat filter when baking**, as otherwise the baking time is longer and the surface will brown unevenly.
- Always count the shelf positions from the bottom upwards.
- Insert baking sheets with the bevelled edge to the front!
- Always place cake tins in the middle of the shelf.
- With BAKING or CONVENTIONAL you can also bake with two tins at the same time by placing them side by side on the shelf. There is no significant increase in baking time.

Notes on the baking tables

In the tables you will find information on temperatures, cooking times and shelf positions for a selection of dishes.

- The temperatures and cooking times are for guidance only since these are dependent on the mixture, quantity and cake tin used.
- When using for the first time, we recommend setting the lower temperature, and only if necessary, e.g. if increased browning is required or the cooking time is too long, select a higher temperature.
- If you cannot find specific information for one of your own recipes, use information given in a similar recipe for guidance.
- When cakes are baked on trays or in tins on more than one oven position at once the baking time may be increased by 10-15 minutes.
- Items that might drip (e.g., pizzas, fruit flans) should only be prepared on one level.
- Variations in the height of the item to be baked can lead to different degrees of browning at the start of baking. In this case **please do not change the temperature setting**. Differences in the degree of browning will balance out during baking.



For longer cooking times switch off the oven approx. 10 minutes before the end of the cooking time to make use of the residual heat.

Unless otherwise stated, the information in the tables assumes starting with a cold oven.

Baking Table

Baking on one shelf position

Type of cake or pastry	BAKING		CONVENTIONAL		Time
	Shelf position from bottom	Temperature °C	Shelf position from bottom	Temperature °C	For both functions Hrs.: Mins.
Cakes in cake tins					
Ring-shaped or bowl-shaped cakes	1	150-160	1	160-180	0:50-1:10
Madeira cake/ king cake	1	140-160	1	150-170	1:10-1:30
Sponge cake	1	150-160	1	160-180	0:25-0:40
Shortcrust pastry flan base	3	170-180	2	190-210 ¹	0:10-0:25
Sponge flan base	3	150-170	2	170-190	0:20-0:25
Covered apple flan	1	150-170	1	170-190	0:50-1:00
Savoury flan (e.g., quiche lorraine)	1	160-180	1	190-210	0:30-1:10
Cheesecake	1	140-160	1	170-190	1:00-1:30
Cakes and pastries on baking trays					
Plaited roll/ring	3	160-170	3	170-190	0:30-0:40
Fruit loaf	3	150-170 ¹	3	160-180 ¹	0:40-1:00
Bread (rye bread) initiallythen	1	180-200 ¹ 140-160	2	250 ¹ 160-180	0:20 0:30-1:00
Cream puffs/eclairs	3	160-170 ¹	3	190-210	0:15-0:30
Swiss roll	3	150-170 ¹	3	180-200 ¹	0:10-0:20
Dry streusel cake	3	150-160	3	160-180	0:20-0:40
Butter cake/sugar cake	3	160-170 ¹	3	190-210 ¹	0:15-0:30

Type of cake or pastry	BAKING		CONVENTIONAL		Time
	Shelf position from bottom	Temperature °C	Shelf position from bottom	Temperature °C	For both functions Hrs.: Mins.
Fruit flan (with a yeast dough/sponge base) ²	3	150-170	3	170-190	0:25-0:50
Fruit flans on shortcrust pastry base ¹	3	160-170	3	170-190	0:40-1:20
Tarts with delicate fillings (e.g., curd cheese, cream, sugar-topped cakes)	-	-	3	160-180¹	0:40-1:20
Pizza (with deep topping) ²	1	180-200	1	190-210 ¹	0:30-1:00
Pizza (thin)	1	200-220	1	230-300 ¹	0:10-0:25
Unleavened bread	1	200-220	1	270-300 ¹	0:08-0:15
Flat sweet or savoury pies	1	180-200	1	210-230	0:35-0:50
Biscuits					
Shortcrust biscuits	3	150-160	3	170-190 ¹	0:06-0:20
Small piped biscuits	3	140-150	3	160-180	0:10-0:40
Sponge fingers	3	150-160	3	170-190	0:15-0:20
Meringues	3	80-100	3	100-120	2:00-2:30
Macaroons	3	100-120	3	120-140	0:30-0:60
Small pastries made with yeast dough	3	160-170	3	170-190	0:20-0:40
Small pastries made with puff pastry	3	170-180¹	3	190-210 ¹	0:20-0:30
Bread rolls	3	180-200¹	3	180-220 ¹	0:20-0:35

1) Pre-heat the oven

2) Use the combination/fat tray or the fat tray!

Information printed in bold type indicates the **best oven function in each case.**

Baking on several shelf positions

Type of cake or pastry	FAN COOKING			Time Hours: Mins.
	Shelf position from bottom		Tempera- ture °C	
	2 Levels	3 Levels		
Cakes and pastries on baking sheets				
Cream puffs/eclairs	1/4	-	160-180 ¹	0:35-0:60
Dry streusel cake	1/4	-	140-160	0:30-0:60
Biscuits				
Shortcrust biscuits	1/4	1/3/5	150-160	0:15-0:35
Small piped biscuits	1/4	1/3/5	140-150	0:20-0:60
Sponge fingers	1/4	-	160-170	0:25-0:40
Meringues	1/4	-	80-100	2:10-2:50
Macaroons	1/4	-	100-120	0:40-1:20
Small pastries made with yeast dough	1/4	-	160-170	0:30-0:60
Small pastries made with puff pastry	1/4	-	170-180 ¹	0:30-0:50
Bread rolls	1/4	-	180-190 ¹	0:30-0:55

Tips for Baking

Baking result	Possible cause	Solution
The cake is under-cooked at the bottom	Wrong shelf position	Insert the cake at a lower shelf position
The cake collapses (is sticky, soft in the middle, damp patches)	Cooking temperature too high	Set to a lower temperature
	Cooking time too short Too much liquid in mixture	Increase cooking time Cooking times may not be reduced by using a higher cooking temperature Next time use less liquid. Check that you have beaten the mixture for the correct length of time, particularly when using a food-processor.
Cake is too dry	Cooking temperature too low	Set a slightly higher baking temperature next time
	Cooking time too long	Reduce cooking time
Cake is unevenly browned	Cooking temperature too high and cooking time too short	Set to a lower temperature and increase cooking time
	Mixture is spread unevenly	Spread mixture evenly on the baking tray
	Fat filter is still in position	Remove fat filter
Cooking time too long	Temperature too low	Set a slightly higher baking temperature next time
	Fat filter is still in position	Removing the fat filter

Pies and Gratin Table

	CONVENTIONAL		ROTITHERM		Time
	Shelf position from bottom	Temperature °C	Shelf position from bottom	Temperature °C	Hours: Mins.
Pasta bake	1	180-200	1	160-170	0:45-1:00
Lasagne	1	180-200	1	160-170	0:25-0:40
Vegetables au gratin ¹	1	200-220	1	160-170	0:15-0:30
Pizza baguettes ¹	1	200-220	1	160-170	0:15-0:30
Sweet soufflés	1	180-200	-	-	0:40-0:60
Fish pies	1	180-200	1	160-170	0:30-1:00
Stuffed vegetables	1	180-200	1	160-170	0:30-1:00

1) Pre-heat the oven.

Information printed in bold type indicates the **best oven function** for the dish.

Frozen Ready Meals Table

Food to be cooked	Shelf position from bottom	Oven function	Temperature	Time
Frozen pizza	3	CONVENTIONAL	in accordance with the maker's instructions	in accordance with the maker's instructions
Chips ¹ (300-600 g)	3	ROTITHERM	200-220 °C	15-25 Mins.
Baguettes	3	CONVENTIONAL	in accordance with the maker's instructions	in accordance with the maker's instructions
Fruit flan	3	CONVENTIONAL	in accordance with the maker's instructions	in accordance with the maker's instructions

1) Comment: Turn chips 2-3 times during cooking.



When frozen foods are used the trays inserted may distort during cooking. This is because of the large differences in temperature between the frozen item and the oven. Once the trays have cooled the distortion will disappear again.

Roasting

Use the ROTITHERM or CONVENTIONAL oven functions for roasting.

Ovenware for roasting

- Any heat-resistant dish is suitable for roasting (refer to the manufacturer's instructions!).
- If the dish has plastic handles, check that they are heat-resistant (refer to manufacturer's instructions!).
- Large roasts can be roasted **directly on the universal baking tray or on the shelf with the universal baking tray underneath** (e.g. turkey, goose, 3-4 chickens, 3-4 knuckles of veal).
- We recommend that all lean pieces of meat should be roasted **in a casserole dish with a lid** (e.g. veal, marinated beef, pot roast, frozen meat.) In this way the meat will retain its juices.
- In order to obtain a tasty outside crust we recommend roasting pieces of meat in a **casserole dish without a lid** (e.g. roast pork, lamb and mutton, meat loaf, duck, 1-2 knuckles of veal, 1-2 chickens, small fowl, roast beef, fillets, game).



Tip: The oven will be less dirty if you always use a dish for roasting!

Shelf positions

- Please see the following table for the shelf positions to be used.



Notes on the roasting table

Information is given in the table on suitable oven functions, temperature settings, cooking times and shelf positions for various types of meat. The information is for guidance.

- We recommend roasting meat and fish **with a minimum weight of 1kg in the oven.**
- Generally the CONVENTIONAL function is particularly suitable for very lean meat such as fish or game. For all other types of meat (especially poultry) we recommend the ROTITHERM function.
- To stop meat juices or fat burning onto dishes or the oven, we recommend adding a little liquid to the roasting dish.
- Turn the joint as required (after 1/2 - 2/3 of the cooking time).



Tip: Baste large joints and poultry several times during cooking with the meat juices. This will produce better roasting results.



Switch off the oven approx. 10 minutes before the end of the cooking time to make use of the residual heat.

Roasting Table

Type of meat	Quantity	CONVENTIONAL		ROTITHERM		Time
	Weight	Shelf position from bottom	Temperature °C	Shelf position from bottom	Temperature °C	Hours: Mins.
Beef						
Pot roast	1-1.5 kg	1	200-250	-	-	2:00-2:30
Roast beef or fillet						per cm of thickness
- rare	per cm of thickness	1	250-270 ¹	1	190-200	0:05-0:06
- medium rare	per cm of thickness	1	250-270 ¹	1	180-190	0:06-0:08
- well done	per cm of thickness	1	210-250 ¹	1	170-180	0:08-0:10
Pork						
Shoulder, neck ham joint	1-1.5 kg	1	210-220	1	160-180	1:30-2:00
Chop, smoked loin chop	1-1.5 kg	1	180-190	1	170-180	1:00-1:30
Meat loaf	750 g-1 kg	1	170-180	1	160-170	0:45-1:00
Knuckle of pork (pre-cooked)	750 g-1 kg	1	210-220	1	150-170	1:30-2:00
Veal						
Roast veal	1 kg	1	210-220	1	160-180	1:30-2:00
Knuckle of veal	1.5-2 kg	1	210-225	1	160-180	2:00-2:30
Lamb						
Leg of lamb, roast lamb	1-1.5 kg	1	210-220	1	150-170	1:15-2:00
Saddle of lamb	1-1.5 kg	1	210-220	1	160-180	1:00-1:30

Type of meat	Quantity	CONVENTIONAL		ROTITHERM		Time
	Weight	Shelf position from bottom	Temperature °C	Shelf position from bottom	Temperature °C	Hours: Mins.
Game						
Saddle of hare, haunch of hare	up to 1 kg	3	220-250 ¹	3	160-170	0:25-0:40
Saddle of venison	1.5-2 kg	1	210-220	1	160-180	1:15-1:45
Haunch of venison	1.5-2 kg	1	200-210	1	160-180	1:30-2:15
Poultry						
Poultry portions 4-6 pieces	per 200-250 g	3	220-250	3	180-200	0:35-0:50
Chicken halves 2-4 pieces	per 400-500 g	3	220-250	3	180-200	0:35-0:50
Chicken, poulard	1-1.5 kg	1	220-250	1	170-180	0:45-1:15
Duck	1.5-2 kg	1	210-220	1	160-180	1:00-1:30
Goose	3.5-5 kg	1	200-210	1	150-160	2:30-3:00
Turkey	2.5-3.5 kg 4-6 kg	1	200-210 180-200	1	150-160 140-150	1:30-2:00 2:30-4:00
Fish (steaming)						
Whole fish	1-1.5 kg	2/3	210-220	2/3	160-170	0:45-1:15

1) Pre-heat the oven.

Information printed in bold type indicates the **best oven function**.

Meat Probe Table

Food to be Cooked	Meat Core Temperature
Beef	
Pot roast	90 – 95 °C
Rib steak or fillet steak rare	45 – 50 °C
medium	60 – 65 °C
well done	75 – 80 °C
Pork	
Shoulder of pork, ham joint, neck	80 – 82 °C
Chop (saddle), smoked pork loin	75 – 80 °C
Meat loaf	75 – 80 °C
Veal	
Roast veal	75 – 80 °C
Knuckle of veal	85 – 90 °C
Mutton / lamb	
Leg of mutton	80 – 85 °C
Saddle of mutton	80 – 85 °C
Roast lamb, leg of lamb	75 – 80 °C
Game	
Saddle of hare	70 – 75 °C
Leg of hare	70 – 75 °C
Whole hare	70 – 75 °C
Saddle of venison	70 – 75 °C
Leg of venison	70 – 75 °C

Grilling

To grill use the DUAL GRILL or SINGLE GRILL oven function with a temperature setting of 300 °C.



Important: Always grill with the oven door closed.



Always pre-heat the empty oven **for 5 minutes using the grill functions!**

Ovenware for grilling

- Use the shelf unit and universal tray together for grilling.

Shelf positions

- For grilling flat foods you should mainly use the **4th shelf position from the bottom.**

Notes on the grilling table

The grilling times are only for guidance and will vary depending on the type and quality of meat or fish.

- Grilling is particularly suitable for flat pieces of meat and fish.
- Turn the food halfway through the grilling time.

Grilling Table

Food for grilling	Shelf position from bottom	Grilling time	
		1st side	2nd side
Rissoles	4	8-10 mins.	6-8 mins.
Fillet of pork	4	10-12 mins.	6-10 mins.
Grilled sausages	4	8-10 mins.	6-8 mins.
Beef fillet steaks, veal steaks	4	6-7 mins.	5-6 mins.
Fillet of beef, sirloin (approx. 1 kg)	3	10-12 mins.	10-12 mins.
Toast ¹	3	2-3 mins.	2-3 mins.
Toast with topping	3	6-8 mins.	-

1) Do not use the universal baking tray together with the grilling shelf unit.

Bio-Functions

The low temperatures that can be set on this oven enable meat to be cooked so that it is particularly tender and juicy. Yoghurt can also be made, dough proven and fruit dried in the oven.



Caution: The suggested temperature must be changed for all bio-functions!



When roasting at low temperatures you will need up to 20 percent less energy than when roasting conventionally.

Low Temperature Roasting

Use the ROTITHERM oven function for low temperature roasting.



Important: Use the fat filter when roasting!

Ovenware for roasting

- Any heat-resistant dish is suitable for roasting.
- If the dish has plastic handles, check that they are heat-resistant.
- When roasting at low temperatures, always **roast uncovered without a lid.**

Shelf positions

- Use the **1st shelf position from the bottom** for low temperature roasting.

General information

Roasting is performed **in 2 stages:**

- Select a high temperature for browning.
- Then reduce to a lower temperature.

Notes on low temperature roasting

The roasting times are only for guidance and are dependent on the type and quality of the meat or fish.

- The thicker and heavier a piece of meat, the longer the browning time and subsequent final roasting time.
 - It is only necessary to turn whole poultry.
 - Only add vegetables after approx. 2/3 of the browning time.
 - **Once the item has been browned do not open the oven door again!**
(Turn poultry first.) The loss of heat would significantly extend the roasting time.
1. Prepare meat as usual (wash, dry, season, tie into specific shape if required, etc.).
 2. Select the ROTITHERM oven function.
 3. **Change** the suggested temperature to the **roasting temperature for browning** according to the table.
 4. At the end of the browning time **change the setting** to the **final roasting temperature**.

Low Temperature Roasting Table

		ROTITHERM			
Food to be roasted	Weight kg	1st Stage Browning		2nd Stage Final roasting	
		Temperature °C	Time Mins.	Temperature °C	Time Mins.
Meat		220			
Roast beef	1-1.5		24-45	85	30-60
Beef, veal fillet	1-1.5		20-40	85	20-40
Saddle of veal	1-2		30-50	90	20-60
Game		220			
Saddle of venison	1.5-2		25-45	90	20-60
Leg of venison	1.5-2		25-45	120	40-120
Fish		180			
Sea trout	0.5-1		15-20	80	10-20
Salmon (middle piece)	1-2		25-40	80	10-20
Zander / pike	0.7-1.5		15-35	80	10-20



We recommend low temperature roasting for:

tender, lean pieces of meat and fish.

Low temperature roasting is not suitable for:

e.g., pot roast, pork joints.

Making Yoghurt

Use the CONVENTIONAL oven function to prepare yoghurt.

Ovenware for making yoghurt

- Use cups or glasses of approx. 150ml capacity as containers for yoghurt and cover with foil or a lid.

Shelf position

- Place the shelf in the **3rd position from the bottom**.

1. Bring the milk to the boil (e.g. 1 litre for 6-8 portions).
2. Leave the milk to cool to 40 °C.
3. Stir a pot of live natural yoghurt culture (approx. 150g) into the milk, pour into containers and close with a lid.
4. Place the containers on the shelf.
5. Select CONVENTIONAL oven function and **change the suggested temperature to 40 °C**.
6. Remove the yoghurt after approx. 5-8 hours (as soon as it sets).

Proving Dough

Use the CONVENTIONAL oven function to prove dough.

Ovenware for proving dough

- Place the dough in a bowl that is heat resistant up to 40 °C.

Shelf position

- Insert the shelf in the **2nd shelf position from the bottom**.

1. Cover the bowl containing the prepared dough with transparent film and place on the shelf.
2. Select the CONVENTIONAL oven function and **change** the suggested temperature **to 40 °C**.
3. Leave the dough to rise until it has doubled in size.

Drying

Use the FAN COOKING oven function for drying.

Ovenware for drying

- Line the shelf or baking tray with parchment or greaseproof paper.

Shelf positions

- You can dry foods on up to 2 positions simultaneously.
- Insert the shelf or baking tray in the **1st and 4th position from the bottom**.



Notes on drying

- Spread the prepared foods for drying evenly on the shelf or baking tray.
- Turn the foods occasionally as they dry.
- Remove the foods when they can still be bent but no more juice is produced.

Food	FAN COOKING	
	Temperature °C	Time Hrs.
Vegetables		
Chilli peppers (slices)	50-75	6 - 8
Vegetables for making soup	50-75	5 - 6
Mushrooms	50-75	5 - 6
Herbs	50-75	6 - 8
Fruit		
Plums	50-75	8 - 10
Apricots	50-75	8 - 10
Sliced apple	50-75	6 - 8
Pears	50-75	6 - 9

Defrosting

To defrost use the oven function DEFROST without setting a temperature.

Dishes for defrosting

- Remove packaging and place the food on a plate on the shelf.
- Do not use a plate or dish to cover as these significantly increase the defrosting time.

Shelf positions

- Insert the shelf in the **1st position from the bottom** to defrost.

Notes on the defrosting table

The table below offers some guidance on defrosting times.

Defrosting Table

Dish	Defrosting time Mins.	Final defrosting time Mins.	Note
Chicken, 1000 g	100-140	20-30	Place the chicken on an upside-down saucer on a large plate. Halfway through cooking turn or cover with foil.
Meat, 1000 g	100-140	20-30	Halfway through cooking turn or cover with foil.
Meat, 500 g	90-120	20-30	Halfway through cooking turn or cover with foil.
Trout, 150 g	25-35	10-15	Do not cover.
Strawberries, 300 g	30-40	10-20	Do not cover.
Butter, 250 g	30-40	10-15	Do not cover.
Cream, 2 x 200 g	80-100	10-15	Do not cover (Cream may be whipped when some of it is still slightly frozen)
Flan, 1400 g	60	60	Do not cover.

Preserving

Use the BOTTOM HEAT oven function for preserving.

Preserving jars

- For preserving use only commercially available preserving jars that are all the same size.



Screw-top jars, jars with a bayonet fastening and metal containers are unsuitable.

Shelf positions

- Use the **1st shelf position from the bottom** for preserving.

Notes on preserving

- Use the baking tray for preserving. There is room for up to 6 preserving jars each with a capacity of 1 litre on this tray.
- The preserving jars should all be filled to the same level and closed.
- Position the preserving jars on the baking tray so that they do not come into contact with one another.
- Pour about 1/2 litre of water into the baking tray so that there is sufficient moisture in the oven.
- As soon as bubbles begin to appear in the liquid in the first jars (for 1-litre jars this takes about 35–60 minutes), switch off the oven or reduce the temperature to 100 °C (see table).

Preserving Table

The stated times and temperatures are for guidance only.

Preserves	Temperature in °C	Preserving time until bubbles form Mins.	Continued cooking at 100°C Mins.	in switched off oven standing time
Soft fruit				
Strawberries, blueberries, raspberries, ripe gooseberries	160-170	35-45	-	-
Unripe gooseberries	160-170	35-45	10-15	-
Stone fruit				
Pears, quinces, plums	160-170	35-45	10-15	-
Vegetables				
Carrots	160-170	50-60	5-10	60
Mushrooms	160-170	40-60	10-15	60
Gherkins	160-170	50-60	-	
Mixed Pickles	160-170	50-60	15	-
Kohlrabi, peas, asparagus	160-170	50-60	15-20	-
Beans	160-170	50-60	-	-
Plum purée	160-170 50	45 -	6-8 hrs.	- -

Cleaning and Care



Warning: For safety reasons cleaning the appliance with a steam jet cleaner or high-pressure water cleaner is **not permissible!**

Exterior of the Appliance

Wipe the front of the appliance with a soft cloth dipped in warm soapy water.

- Do not use scourers, caustic cleaners or abrasive items.
- Use commercially available cleaners for metal fronts.

Oven Interior

Cleaning after each use



Caution: The oven must be switched off and cold before cleaning.



Clean the appliance after each use. This is the easiest way to remove spills and prevents them being burnt on.

1. Switch on the oven lighting for cleaning.
2. Every time you use the oven, wipe it out afterwards with water and washing-up liquid, then dry. Do not use any abrasive items.



Remove stubborn marks with special oven cleaners.

"CLEANING" oven function

Using the CLEANING oven function you can pre-heat the oven to the optimum temperature for oven sprays to take effect.



Important: Only use oven sprays that require a heated oven. **Refer to the manufacturer's instructions!**

1. Press additional functions selection button repeatedly until "CLEANING" is illuminated.

"CL" will appear in the display.

The oven will now heat up to the necessary temperature.

The first acoustic signal will sound after approx. 15 minutes.

After a further 5 minutes a second acoustic signal will sound for 2 minutes.

"0.00" will flash in the display.



The acoustic signal can be cancelled by pressing any button. The time will then appear in the display.

The optimum cleaning temperature has now been reached.

2. Spray the oven spray into the interior of the oven and leave to take effect. (See manufacturer's instructions!)
3. Wipe the oven clean.

Accessories

Wash all slide-in units (shelf unit, baking tray, shelf support rails etc.) after each use and dry well. Soak briefly to make them easier to clean.

Fat Filter

1. Clean the fat filter in hot water and washing up liquid or in the dishwasher.
2. Badly burned on soiling can be removed by boiling the filter in a little water to which 2-3 tablespoonsful of dishwasher cleaner has been added.

Shelf Support Rails

The shelf support rails on the left and right hand sides of the oven can be removed for cleaning the side walls.

Removing the shelf support rails

First pull the front of the rail away from the oven wall (1) and then unhitch at the back (2).

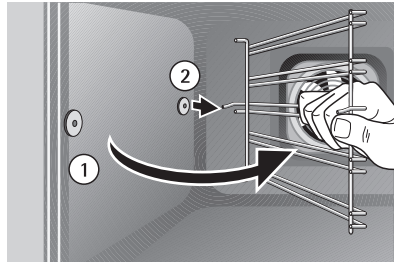
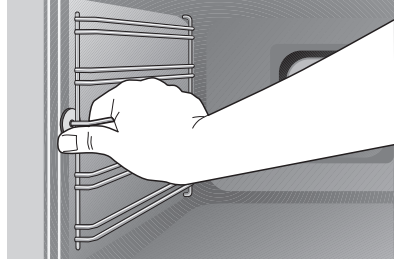

Fitting the shelf support rails



Important! The rounded ends of the guide rails must be pointing forwards!

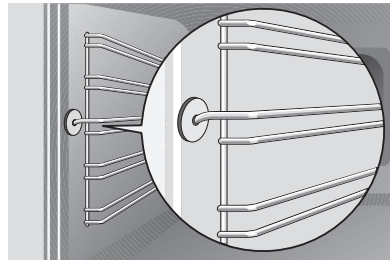

To re-insert, first hook the rail into place at the back (1) and then insert the front and press into place (2).

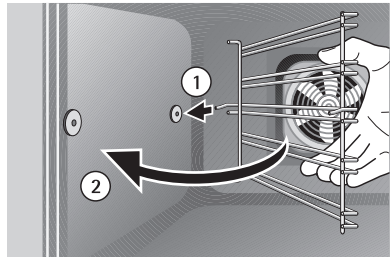

Oven Lighting



Warning: There is a danger of electric shock! Prior to changing the oven light bulb:

- Switch off the oven!
- Remove the fuses in the fuse box or switch off the circuit breaker.



Place a cloth on the oven floor to protect the oven light and glass cover.

Changing the rear oven light/Cleaning the glass cover

1. Remove the glass cover by turning it anti-clockwise and then clean it.
2. If necessary:
replace bulb with a 40 watt, 230 V, 300 °C heat-resistant, oven light bulb.
3. Refit the glass cover.

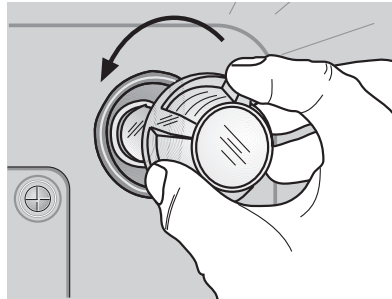

Changing side oven light/Cleaning glass cover

1. Remove the left shelf support rail.
2. Remove the glass cover with the aid of a narrow, blunt implement (e.g., teaspoon) and clean it.
3. If necessary:
replace bulb with a 25 watt, 230 V, 300 °C heat-resistant, oven light bulb.
4. Refit the glass cover.
5. Insert the shelf support rail.

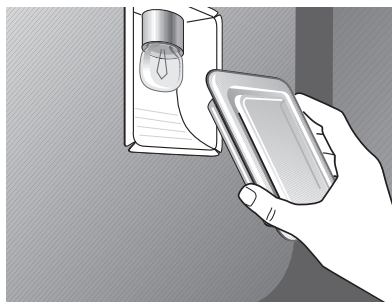
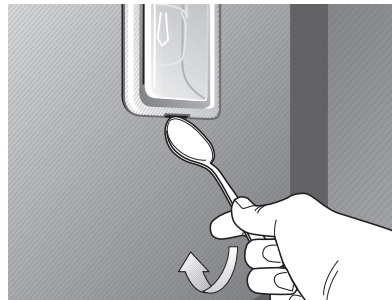

Cleaning the Oven Ceiling

The upper heating element can be folded down to make it easier to clean the oven ceiling.

Folding down the heating element



Warning: Only fold down the heating element when the oven is switched off and there is no risk of being burnt!

1. Remove the side shelf support rails.
2. Grip the heating element at the front and pull it forwards and out over the support lug on the inner wall of the oven.
3. The heating element will now fold down.



Caution: Do not use force to press the heating element down! The heating element might break.

Cleaning the oven ceiling

Repositioning the heating element

1. Move the heating element back up towards the oven ceiling.
2. Pull the heating element forwards against the spring pressure and guide it over the oven support lug.
3. Settle it onto the support.
4. Insert shelf support rail.



Important: The heating element must be positioned correctly and securely on both sides above the support lug on the inner wall of the oven (2).

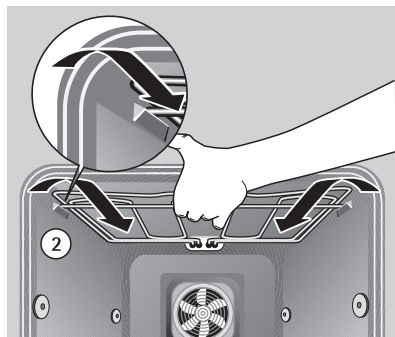
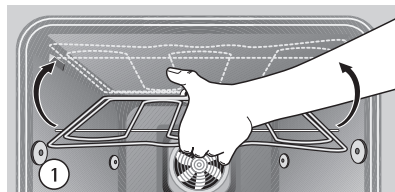
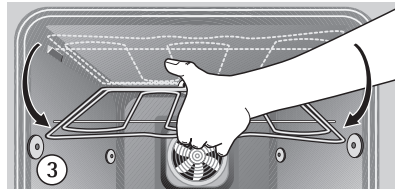
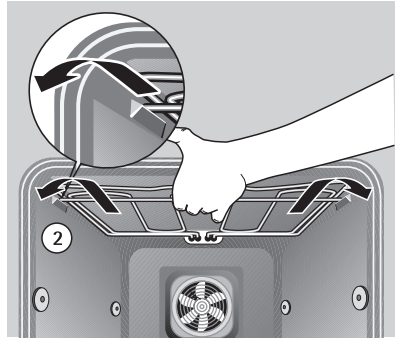

Oven Door

The oven door of your appliance may be removed for cleaning.

Removing the oven door

1. Open the oven door completely.
2. **Completely** fold back the **brass-coloured clamping lever** on **both** door hinges.
3. Grip the oven door with both hands on the sides and close it to about $\frac{3}{4}$ **going past the point of resistance**.
4. Pull the door away from the oven (**Caution: heavy!**).
5. Place the door, with the outer surface downwards, on a soft, flat surface, for example a blanket, to avoid scratches.

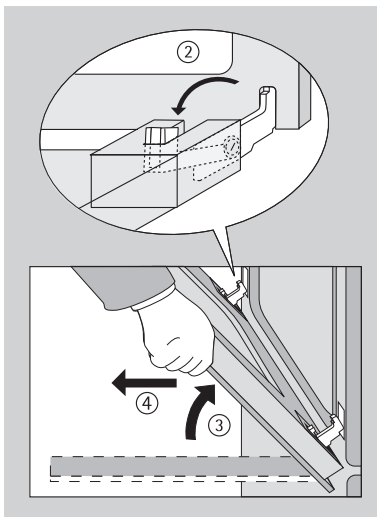

Hanging the oven door

1. With both hands take hold of the sides of the door from the side on which the handle is positioned.
2. Hold the door at an angle of approx. 60° .
3. Slide the door hinges **simultaneously** as far as possible into the two slots on the right and left at the bottom of the oven.
4. Lift the door up until resistance is met and then open fully.
5. Lift the brass-coloured clamping levers on both door hinges back to their original position.
6. Close the oven door.

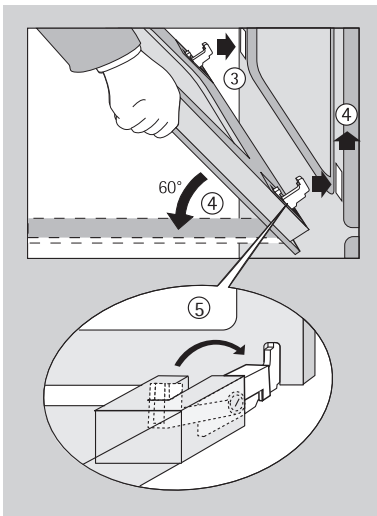

Oven Door Glass

The oven door is fitted with three glass panels mounted one behind the other. The inner panels may be removed for cleaning.



Warning: Carry out the following steps only when the oven door is un-hinged! When left on its hinges, the door could rise rapidly due to the lighter weight when the glass is removed and could cause injury.



Important: Using force, especially on the edges of the front glass panel, may break the glass.

Removing the top door glass

1. Unhinge the oven door and place it on a soft, flat surface with the handle facing down.
2. Take hold of the upper glass panel at the lower edge and slide it against the spring pressure in the direction of the oven door handle until it is free at the base.
3. Raise the panel **gently** at the base and pull out.

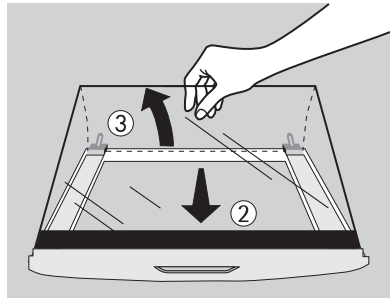

Removing the middle door glass

1. Grip the bottom edge of the middle glass panel and push it in the direction of the oven door handle until it is free at the base.
2. Raise the panel gently at the base and pull out.

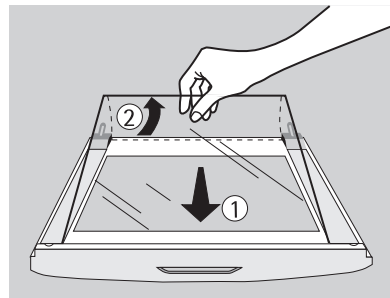

Clean the glass door panels

Inserting the middle door glass

1. Insert the middle glass panel at an angle from above into the section of the door in which the handle is located.
2. Lower the middle glass panel and slide it under the lower bracket towards the lower door edge as far as it will go.

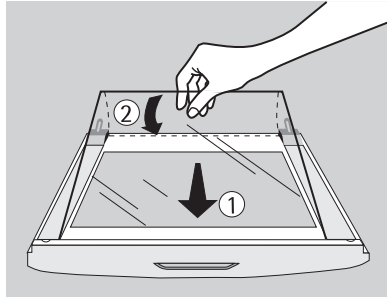

Inserting the upper door glass

1. Insert the upper glass panel at an angle from above into the section of the door in which the handle is located.
2. Lower the glass panel. Lay the panel against the spring on the lower door edge in front of the retaining section on the handle side, and **slide it under the retaining section**. The glass panel must be firmly in position!

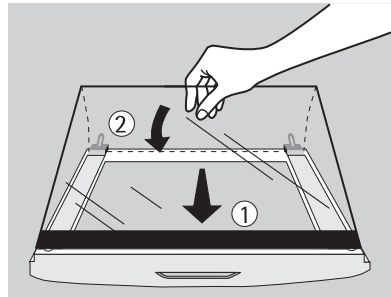

Re-hang the oven door

What to do if ...

Symptom	Possible cause	Solution
The oven does not heat up.	The oven has not been switched on.	Switch on the oven.
	The time has not been set.	Set the time.
	The necessary settings have not been made.	Check the settings.
	The circuit breaker (at the household fuse box) has tripped or the fuse has blown.	Check the fuse. If the circuit breaker trips or the fuse blows several times, please call an approved electrician.
The oven lighting does not come on.	The oven light bulb has blown.	Replace the light bulb in the oven (see Cleaning and Care).

If you cannot rectify the fault with the help of the information given above, please contact your specialist dealer or customer service.



Warning: Repairs to the appliance may only be carried out by qualified specialists. Improperly effected repairs may result in considerable risk to the user.

If the appliance has been used improperly, the customer service engineer's visit or that of the specialist dealer will not be free of charge, even during the warranty period.

Information for appliances with a metal front:



Due to the cold front of your appliance the inner door glass may steam over briefly if you open the door during or shortly after baking or roasting.

Technical Data

Oven Interior Dimensions

Height x Width x Depth	31 cm x 41 cm x 41 cm
Capacity (usable capacity)	52 l

Regulations, Standards, Directives

This appliance meets the following standards:

- EN 60 335-1 and EN 60 335-2-6
relating to the safety of electric appliances for household use and similar purposes and
- EN 60350 and
- DIN 44546 / 44547 / 44548
relating to the operating features of household electric cookers.
- EN 55014-2
- EN 55014
- EN 61000-3-2
- EN 61000-3-3
relating to basic requirements for electromagnetic compatibility protection (EMC).

CE This appliance complies with the following EC directives:

- 73/23/EWG dated 19.02.1973 (Low Voltage Directive)
- 89/336/EWG dated 03.05.1989 (EMC Directive including Amending Directive 92/31/EWG).

Index

A

- Accessories11, 19
- Additional Functions 21

B

- Baking15, 36
- Baking tray 11
- Bottom heat 16
- Button locking feature 34

C

- Cakes 22
- Child safety feature 33
- Cleaning 23
 - accessories 59
 - initial cleaning 13
 - oven door 63
 - shelf support rails 60
- Clock 14
 - functions 26
 - setting the time12, 26
- Combination shelf 11
- Control panel 9
- Conventional 15
- Customer service 71

D

- Defrosting16, 55
- Description of the appliance 8
- Dishes with toppings 42
- Disposal 7
- Door 63
- Dual grill 16

F

- Fan cooking 15
- Fat filter 59
- Fat tray 11
- Frying 44

G

- Grilling 49

I

- Insert anti-tip 19

K

- Keeping Food Warm 16

L

- Light16
- Lighting 18, 61

M

- Meat probe24

O

- Oven
 - accessories11
 - door63
 - functions15
 - light61

P

- Pizza21
- Poultry23
- Preserving56

R

- Ready meals43
- Repairs5
- Rotitherm15

S

- Safety5
- Shelf19
- Shelf support rails60
- Single grill16
- Soufflés42
- Steam vent10

T

- Tables and tips36
- Time display32

U

- Universal baking tray19
- Using the oven14

Service

The section "What do I do if..." lists some faults that you can remedy yourself. Look there first if a fault occurs.

Is it a technical fault?

Then contact your nearest customer service centre. (Addresses and telephone numbers can be found under "Customer Service Centres".)

Always prepare in advance for the discussion. By doing so you will make it easier to diagnose the fault and decide whether customer service is necessary.

Please make a note of the following information as accurately as possible:

- What form does the fault take?
- Under what circumstances does the fault occur?

Prior to the telephone call it is imperative that you make a note of the following appliance code numbers that are given on the rating plate:

- PNC Code (9 digits),
- S No Code (8 digits).

We recommend that you record the code numbers here so that you always have them to hand:

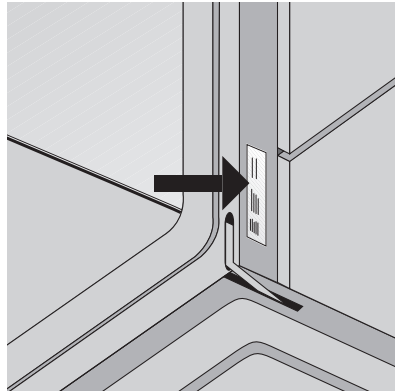

PNC

S No.

When do you incur costs even during the warranty period?

- if you could have remedied the fault using the fault table (see section "What to do if ..."),
- if the customer service technician has to make several journeys because he was not provided with all the relevant information before his visit and therefore, for example, has to fetch spare parts. These multiple trips can be avoided if you prepare for your phone call as described above.

AEG Hausgeräte GmbH
Postfach 1036
D-90327 Nürnberg

<http://www.aeg.hausgeraete.de>

© Copyright by AEG

822 947 538-A-101201-07

Subject to change without notice